

Part Number: KB2770YW

Yellow

Features

- Uniform light emitting area.
- Low current operation.
- Easily mounted on P.C. boards.
- Flush mountable.
- Excellent on/off contrast.
- Can be used with panels and legend mounts.
- RoHS compliant.

Description

The Yellow source color devices are made with Gallium Arsenide Phosphide on Gallium Phosphide Yellow Light Emitting Diode.

Package Dimensions & Internal Circuit Diagram

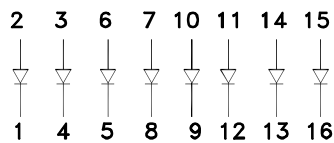
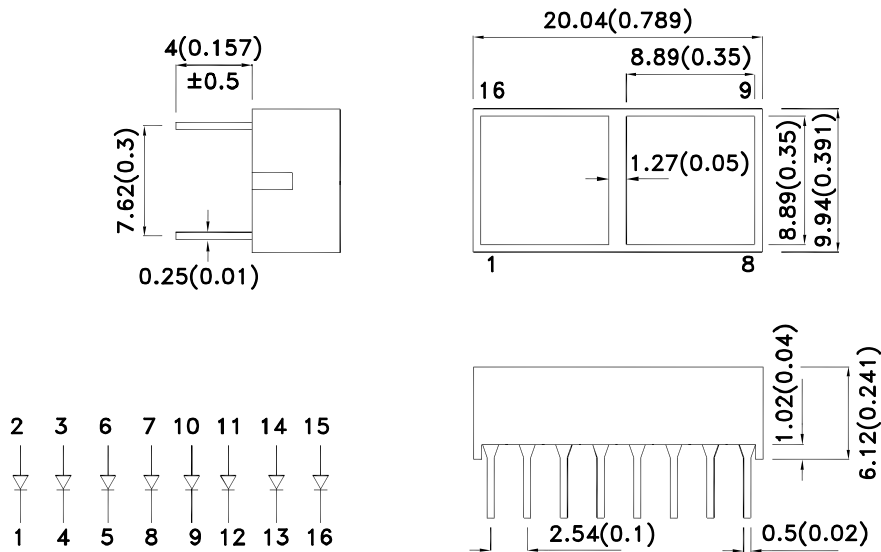

RECOMMENDED PCB LAYOUT

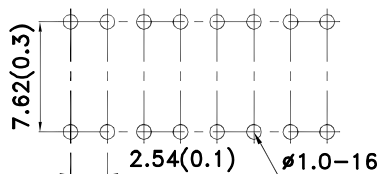

Notes:

1. All dimensions are in millimeters (inches), Tolerance is $\pm 0.25(0.01)$ unless otherwise noted.
2. The specifications, characteristics and technical data described in the datasheet are subject to change without prior notice.



Selection Guide

Part No.	Dice	Lens Type	Iv (mcd) [1] @ 20mA	
			Min.	Typ.
KB2770YW	Yellow (GaAsP/GaP)	White Diffused	10	50

Note:

1. Luminous intensity/ luminous Flux: +/-15%.

Electrical / Optical Characteristics at TA=25°C

Symbol	Parameter	Device	Typ.	Max.	Units	Test Conditions
λ_{peak}	Peak Wavelength	Yellow	590		nm	I _F =20mA
λ_D [1]	Dominant Wavelength	Yellow	588		nm	I _F =20mA
$\Delta\lambda_{1/2}$	Spectral Line Half-width	Yellow	35		nm	I _F =20mA
C	Capacitance	Yellow	20		pF	V _F =0V;f=1MHz
V _F [2]	Forward Voltage	Yellow	2.1	2.5	V	I _F =20mA
I _R	Reverse Current	Yellow		10	uA	V _R =5V

Notes:

1. Wavelength: +/-1nm.
2. Forward Voltage: +/-0.1V.

Absolute Maximum Ratings at TA=25°C

Parameter	Yellow	Units
Power dissipation	75	mW
DC Forward Current	30	mA
Peak Forward Current [1]	140	mA
Reverse Voltage	5	V
Operating / Storage Temperature	-40°C To +85°C	
Lead Solder Temperature[2]	260°C For 3-5 Seconds	

Notes:

1. 1/10 Duty Cycle, 0.1ms Pulse Width.
2. 2mm below package base.



Yellow

KB2770YW

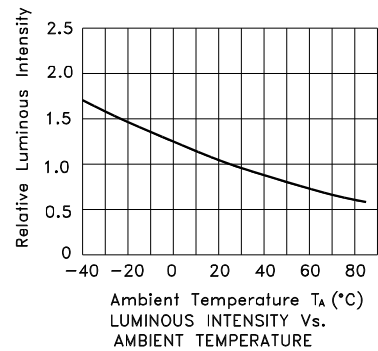
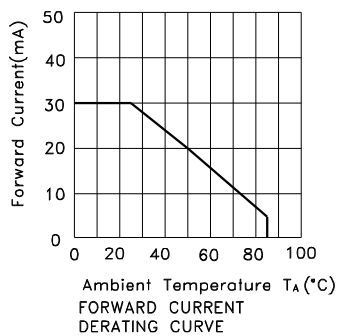
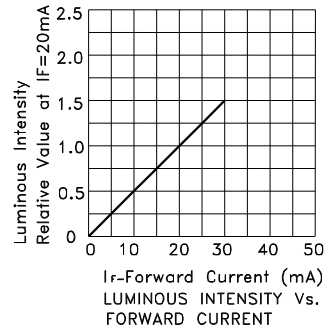
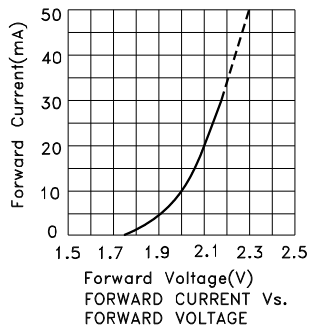

PACKING & LABEL SPECIFICATIONS

KB2770YW

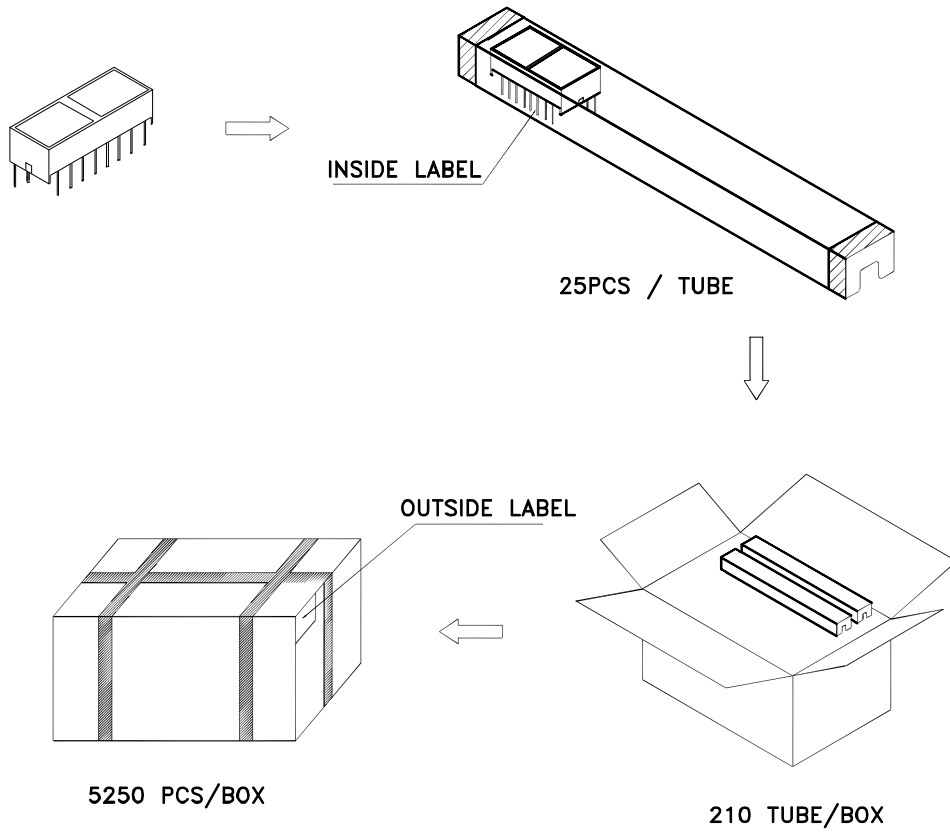

Inside Label On IC-tube

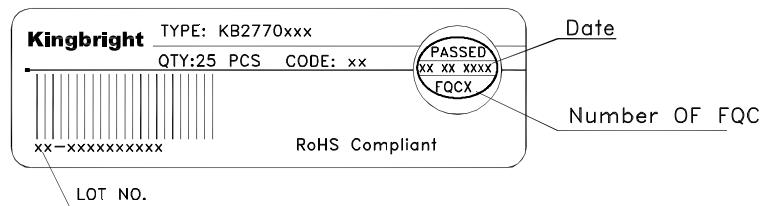

Outside Label On Box

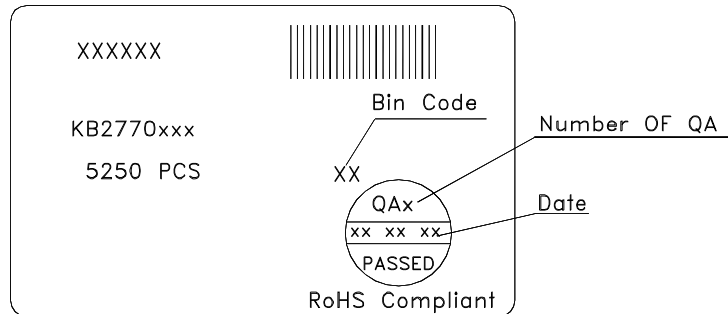

THROUGH HOLE DISPLAY MOUNTING METHOD

Lead Forming

Do not bend the component leads by hand without proper tools.
The leads should be bent by clinching the upper part of the lead firmly such that the bending force is not exerted on the plastic body.



Installation

- 1.The installation process should not apply stress to the lead terminals.
- 2.When inserting for assembly, ensure the terminal pitch matches the substrate board's hole pitch to prevent spreading or pinching the lead terminals.



DISPLAY SOLDERING CONDITIONS

Wave Soldering Profile For Lead-free Through-hole LED.



NOTES:

- 1.Recommend the wave temperature 245°C~260°C.The maximum soldering temperature should be less than 260°C.
- 2.Do not apply stress on epoxy resins when temperature is over 85°C.
- 3.The soldering profile apply to the lead free soldering (Sn/Cu/Ag alloy).
- 4.During wave soldering , the PCB top-surface temperature should be kept below 105°C
- 5.No more than once.

Soldering General Notes:

- a. Through-hole displays are incompatible with reflow soldering.
- b. If components will undergo multiple soldering processes, or other processes where the components may be subjected to intense heat, please check with Kingbright for compatibility.

CLEANING

1. Mild "no-clean" fluxes are recommended for use in soldering.
2. If cleaning is required, Kingbright recommends to wash components with water only. Do not use harsh organic solvents for cleaning, because they may damage the plastic parts. And the devices should not be washed for more than one minute.

CIRCUIT DESIGN NOTES

1. Protective current-limiting resistors may be necessary to operate the Displays.
2. LEDs mounted in parallel should each be placed in series with its own current-limiting resistor.





Стандарт Электрон Связь

Мы молодая и активно развивающаяся компания в области поставок электронных компонентов. Мы поставляем электронные компоненты отечественного и импортного производства напрямую от производителей и с крупнейших складов мира.

Благодаря сотрудничеству с мировыми поставщиками мы осуществляем комплексные и плановые поставки широчайшего спектра электронных компонентов.

Собственная эффективная логистика и склад в обеспечивает надежную поставку продукции в точно указанные сроки по всей России.

Мы осуществляем техническую поддержку нашим клиентам и предпродажную проверку качества продукции. На все поставляемые продукты мы предоставляем гарантию .

Осуществляем поставки продукции под контролем ВП МО РФ на предприятия военно-промышленного комплекса России , а также работаем в рамках 275 ФЗ с открытием отдельных счетов в уполномоченном банке. Система менеджмента качества компании соответствует требованиям ГОСТ ISO 9001.

Минимальные сроки поставки, гибкие цены, неограниченный ассортимент и индивидуальный подход к клиентам являются основой для выстраивания долгосрочного и эффективного сотрудничества с предприятиями радиоэлектронной промышленности, предприятиями ВПК и научно-исследовательскими институтами России.

С нами вы становитесь еще успешнее!

Наши контакты:

Телефон: +7 812 627 14 35

Электронная почта: sales@st-electron.ru

Адрес: 198099, Санкт-Петербург,
Промышленная ул, дом № 19, литера Н,
помещение 100-Н Офис 331