3A Load Switch IC

NO. EA-312-150320

OUTLINE

The R5527K is an N-channel load switch IC with low supply current, Typ. 40 μ A. By using an Nch transistor as a driver transistor, the features of low on resistance and the reverse current protection at on/off state are realized. The R5527K is an ideal load switch IC to supply power from the battery to the load circuit. The R5527K is available in an ultra-small DFN (PLP)1612-4D package which can achieve high-density mounting on boards.

FEATURES

- Input Voltage Range 1.8V to 5.5V
- Typical RON 48m Ω ($V_{IN}=5V$)
46m Ω ($V_{IN}=4.5V$)
45m Ω ($V_{IN}=3.8V$)
68m Ω ($V_{IN}=1.8V$)
- Slew Rate/Inrush Control with t_R 1.5ms (Min.)
- 3A Maximum Continuous Current Capability
- Low Off Switch Current <1 μ A (R5527K001B/D), <2 μ A (R5527K001A/C)
- Reverse Current Blocking (RCB)
- Package DFN(PLP)1612-4D

APPLICATION

- Smart Phones, Tablet PCs
- Storage, Portable Devices

BLOCK DIAGRAMS

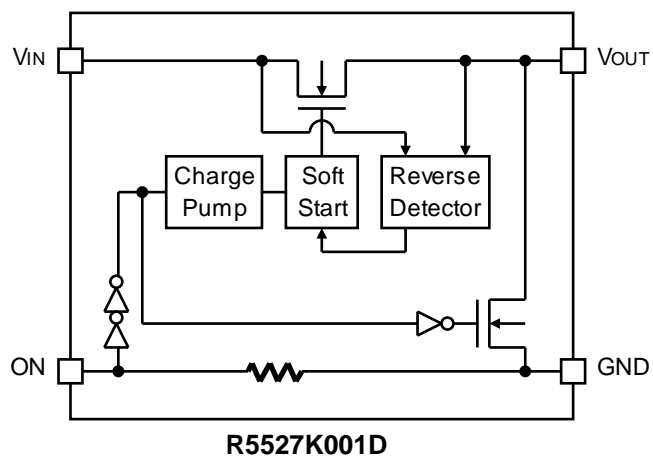
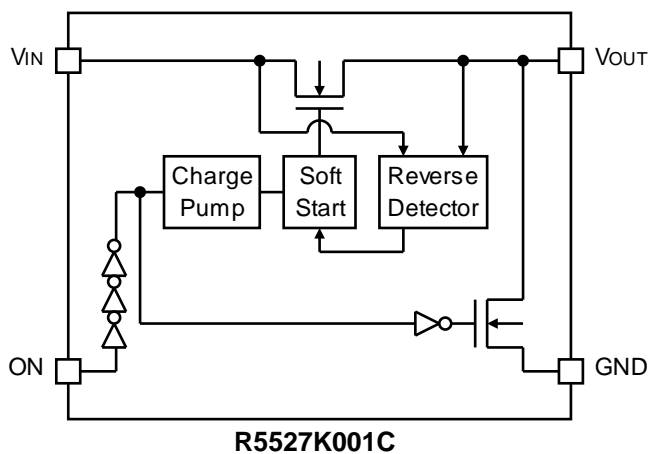
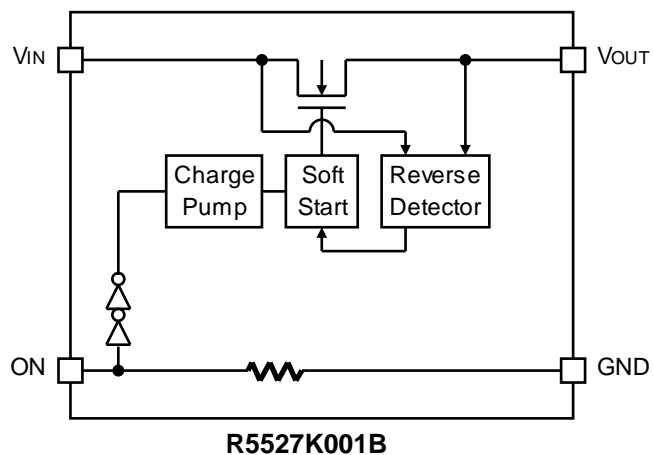
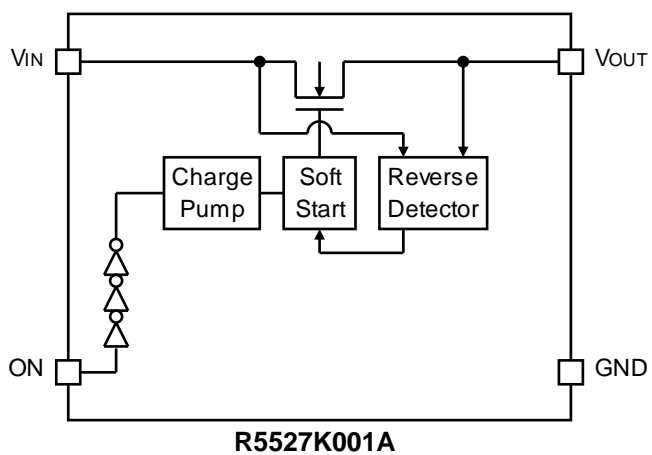

PIN DESCRIPTION

• DFN(PLP)1612-4D

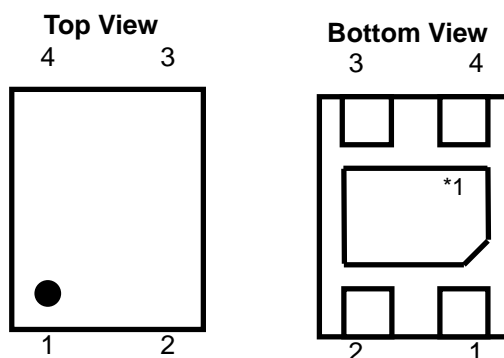

Pin No	Symbol	Pin Description
1	V_{IN}	Supply Input Pin
2	GND	Ground Pin
3	ON	ON/OFF Control Pin, Active High/Low
4	V_{OUT}	Switch Output Pin

*1 The tab on the bottom of the package enhances thermal performance and is electrically connected to GND (substrate level). It is recommended that the tab be connected to the ground plane on the board, or otherwise be left floating.

SELECTION GUIDE

The ON pin polarity and the auto-discharge function for the ICs are user-selectable options.

Product Name	Package	Quantity per Reel	Pb Free	Halogen Free
R5527K001*-TR	DFN(PLP)1612-4D	5,000 pcs	Yes	Yes

*: Specify a combination of the ON pin polarity and the auto-discharge function.

- (A) "L" Active, without auto-discharge function at off state
- (B) "H" Active, without auto-discharge function at off state
- (C) "L" Active, with auto-discharge function at off state
- (D) "H" Active, with auto-discharge function at off state

Auto-Discharge function quickly lowers the output voltage to 0V by releasing the electrical charge in the external capacitor when the ON signal is switched from the active mode to the standby mode.

ABSOLUTE MAXIMUM RATINGS

Symbol	Item	Rating	Unit
V_{IN}	Input Voltage	-0.3 to 6.0	V
V_{ON}	Input Voltage (ON Pin)	-0.3 to 6.0	V
V_{OUT}	Output Voltage	-0.3 to 6.0	V
I_{OUT}	Output Current	3.0	A
P_D	Power Dissipation (DFN(PLP)1612-4D) ^{*1}	Standard Land Pattern 610	mW
T_a	Ambient Temperature	-40 to 85	°C
T_{stg}	Storage Temperature	-55 to 125	°C

^{*1} Refer to *PACKAGE INFORMATION* for detailed information.

ABSOLUTE MAXIMUM RATINGS

Electronic and mechanical stress momentarily exceeded absolute maximum ratings may cause the permanent damages and may degrade the life time and safety for both device and system using the device in the field. The functional operation at or over these absolute maximum ratings are not assured.

RECOMMENDED OPERATING CONDITIONS (ELECTRICAL CHARACTERISTICS)

All of electronic equipment should be designed that the mounted semiconductor devices operate within the recommended operating conditions. The semiconductor devices cannot operate normally over the recommended operating conditions, even if when they are used over such conditions by momentary electronic noise or surge. And the semiconductor devices may receive serious damage when they continue to operate over the recommended operating conditions.

ELECTRICAL CHARACTERISTICS

$V_{IN} = 1.8$ to $5.5V$, $I_{OUT} = 1mA$, $C_{IN} = 1\mu F$, $C_{OUT} = \text{None}$, unless otherwise noted.

The specifications surrounded by are guaranteed by design engineering at $-40^{\circ}C \leq T_a \leq 85^{\circ}C$.

R5527K001A

($T_a=25^{\circ}C$)

Symbol	Item	Conditions	Min.	Typ.	Max.	Unit
V_{IN}	Input Voltage		1.8		5.5	V
$I_{Q(OFF)}$	Off Supply Current	$V_{ON}=V_{IN}, V_{OUT}=\text{OPEN}$		1	2	μA
I_{SD}	Shutdown Current	$V_{ON}=V_{IN}, V_{OUT}=\text{GND}$	$T_a=25^{\circ}C$	1	2	μA
			$T_a=85^{\circ}C$	1	10	μA
I_Q	Quiescent Current	$V_{ON}=\text{GND}, I_{OUT}=0mA$		40	70	μA
R_{ON}	On Resistance	$V_{IN}=5V, I_{OUT}=1A$		48	65	m Ω
		$V_{IN}=4.5V, I_{OUT}=1A$		46		
		$V_{IN}=3.8V, I_{OUT}=1A$		45	60	
		$V_{IN}=3.3V, I_{OUT}=500mA$		45		
		$V_{IN}=2.5V, I_{OUT}=500mA$		51		
		$V_{IN}=1.8V, I_{OUT}=250mA$		68		
V_{IH}	ON Input Logic High Voltage	$V_{IN}=1.8V$ to $5.5V$	1.7			V
V_{IL}	ON Input Logic Low Voltage	$V_{IN}=1.8V$ to $5.5V$			1.2	V
I_{ON}	ON Input Leakage	$V_{ON}=V_{IN}$			1	μA
V_{T_RCB}	RCB Protection Trip Point	$V_{OUT} - V_{IN}$		45		mV
V_{R_RCB}	RCB Protection Release Trip Point	$V_{IN} - V_{OUT}$		25		mV
	RCB Hysteresis			70		mV
I_{SD_OUT}	V_{OUT} Shutdown Current	$V_{ON}=\text{GND}, V_{OUT}=5.5V, V_{IN}=\text{Short to GND}$			10	μA
t_{DON}^{*1}	Turn-On Delay	$V_{IN}=3.8V, R_L=150\Omega, C_L=100\mu F$ Time from ON="H" \rightarrow "L" to $V_{OUT}=V_{IN} \times 10\%$	0.5		2.5	ms
t_R^{*1}	V_{OUT} Rise Time	$V_{IN}=3.8V, R_L=150\Omega, C_L=100\mu F$ Time from $V_{OUT}=V_{IN} \times 10\%$ to $V_{IN} \times 90\%$	1.5		5.0	ms
t_{ON}^{*1}	Turn-On Time	$V_{IN}=3.8V, R_L=150\Omega, C_L=100\mu F$ Time from ON="H" \rightarrow "L" to $V_{OUT}=V_{IN} \times 90\%$	2.0		7.5	ms

All test items listed under *ELECTRICAL CHARACTERISTICS* are done under the pulse load condition ($T_J \approx T_a = 25^{\circ}C$) except RCB Protection Trip Point, RCB Protection Release Trip Point, and RCB Hysteresis.

*1 Rise time from $V_{OUT}=0V$ is defined. Refer to the *TIMING CHART* for detailed information.

$V_{IN} = 1.8$ to $5.5V$, $I_{OUT} = 1mA$, $C_{IN} = 1\mu F$, $C_{OUT} = \text{None}$, unless otherwise noted.

The specifications surrounded by are guaranteed by design engineering at $-40^{\circ}C \leq T_a \leq 85^{\circ}C$.

R5527K001B

(Ta=25°C)

Symbol	Item	Conditions	Min.	Typ.	Max.	Unit	
V_{IN}	Input Voltage		1.8		5.5	V	
$I_{Q(OFF)}$	Off Supply Current	$V_{ON}=GND, V_{OUT}=OPEN$		0.5	1	μA	
I_{SD}	Shutdown Current	$V_{ON}=GND,$ $V_{OUT}=GND$	Ta=25°C		0.5	1	μA
			Ta=85°C		0.5	10	μA
I_Q	Quiescent Current	$V_{ON}=V_{IN}, I_{OUT}=0mA$		40	70	μA	
R_{ON}	On Resistance	$V_{IN}=5V, I_{OUT}=1A$		48	65	m Ω	
		$V_{IN}=4.5V, I_{OUT}=1A$		46			
		$V_{IN}=3.8V, I_{OUT}=1A$		45	60		
		$V_{IN}=3.3V, I_{OUT}=500mA$		45			
		$V_{IN}=2.5V, I_{OUT}=500mA$		51			
		$V_{IN}=1.8V, I_{OUT}=250mA$		68			
V_{IH}	ON Input Logic High Voltage	$V_{IN}=1.8V$ to $5.5V$	1.7			V	
V_{IL}	ON Input Logic Low Voltage	$V_{IN}=1.8V$ to $5.5V$			1.2	V	
I_{ON}	ON Input Leakage	$V_{ON}=GND$			1	μA	
R_{ON_PD}	Pull-Down Resistance at ON Pin	$V_{IN}=V_{ON}=1.8V$ to $5.5V$		3		M Ω	
V_{T_RCB}	RCB Protection Trip Point	$V_{OUT} - V_{IN}$		45		mV	
V_{R_RCB}	RCB Protection Release Trip Point	$V_{IN} - V_{OUT}$		25		mV	
	RCB Hysteresis			70		mV	
I_{SD_OUT}	V_{OUT} Shutdown Current	$V_{ON}=GND, V_{OUT}=5.5V,$ $V_{IN}=\text{Short to GND}$			10	μA	
t_{DON}^{*1}	Turn-On Delay	$V_{IN}=3.8V, R_L=150\Omega, C_L=100\mu F$ Time from ON="L"→"H" to $V_{OUT}=V_{IN} \times 10\%$	0.5		2.5	ms	
t_R^{*1}	V_{OUT} Rise Time	$V_{IN}=3.8V, R_L=150\Omega, C_L=100\mu F$ Time from $V_{OUT}=V_{IN} \times 10\%$ to $V_{IN} \times 90\%$	1.5		5.0	ms	
t_{ON}^{*1}	Turn-On Time	$V_{IN}=3.8V, R_L=150\Omega, C_L=100\mu F$ Time from ON="L"→"H" to $V_{OUT}=V_{IN} \times 90\%$	2.0		7.5	ms	

All test items listed under *ELECTRICAL CHARACTERISTICS* are done under the pulse load condition ($T_j \approx T_a = 25^{\circ}C$) except RCB Protection Trip Point, RCB Protection Release Trip Point, and RCB Hysteresis.

*1 Rise time from $V_{OUT}=0V$ is defined. Refer to the *TIMING CHART* for detailed information.

$V_{IN} = 1.8$ to $5.5V$, $I_{OUT} = 1mA$, $C_{IN} = 1\mu F$, $C_{OUT} = \text{None}$, unless otherwise noted.

The specifications surrounded by are guaranteed by design engineering at $-40^{\circ}C \leq T_a \leq 85^{\circ}C$.

R5527K001C

(Ta=25°C)

Symbol	Item	Conditions	Min.	Typ.	Max.	Unit
V_{IN}	Input Voltage		1.8		5.5	V
I_{SD}	Shutdown Current	$V_{ON}=V_{IN}$, $V_{OUT}=GND$	Ta=25°C	1	2	μA
			Ta=85°C	1	10	μA
I_Q	Quiescent Current	$V_{ON}=GND$, $I_{OUT}=0mA$		40	70	μA
R_{ON}	On Resistance	$V_{IN}=5V$, $I_{OUT}=1A$		48	65	m Ω
		$V_{IN}=4.5V$, $I_{OUT}=1A$		46		
		$V_{IN}=3.8V$, $I_{OUT}=1A$		45	60	
		$V_{IN}=3.3V$, $I_{OUT}=500mA$		45		
		$V_{IN}=2.5V$, $I_{OUT}=500mA$		51		
		$V_{IN}=1.8V$, $I_{OUT}=250mA$		68		
V_{IH}	ON Input Logic High Voltage	$V_{IN}=1.8V$ to $5.5V$	1.7			V
V_{IL}	ON Input Logic Low Voltage	$V_{IN}=1.8V$ to $5.5V$			1.2	V
I_{ON}	ON Input Leakage	$V_{ON}=V_{IN}$			1	μA
V_{T_RCB}	RCB Protection Trip Point	$V_{OUT} - V_{IN}$		45		mV
V_{R_RCB}	RCB Protection Release Trip Point	$V_{IN} - V_{OUT}$		25		mV
	RCB Hysteresis			70		mV
I_{SD_OUT}	V_{OUT} Shutdown Current	$V_{ON}=GND$, $V_{OUT}=5.5V$, $V_{IN}=\text{Short to GND}$			10	μA
t_{DON}^{*1}	Turn-On Delay	$V_{IN}=3.8V$, $R_L=150\Omega$, $C_L=100\mu F$ Time from ON="H"→"L" to $V_{OUT}=V_{IN} \times 10\%$	0.5		2.5	ms
t_R^{*1}	V_{OUT} Rise Time	$V_{IN}=3.8V$, $R_L=150\Omega$, $C_L=100\mu F$ Time from $V_{OUT}=V_{IN} \times 10\%$ to $V_{IN} \times 90\%$	1.5		5.0	ms
t_{ON}^{*1}	Turn-On Time	$V_{IN}=3.8V$, $R_L=150\Omega$, $C_L=100\mu F$ Time from ON="H"→"L" to $V_{OUT}=V_{IN} \times 90\%$	2.0		7.5	ms
R_{LOW}	Nch. On Resistance for Auto-Discharge	$V_{IN}=V_{ON}=5.0V$, $V_{OUT}=0.1V$		20		Ω

All test items listed under *ELECTRICAL CHARACTERISTICS* are done under the pulse load condition ($T_j \approx T_a = 25^{\circ}C$) except RCB Protection Trip Point, RCB Protection Release Trip Point, and RCB Hysteresis.

*1 Refer to the *TIMING CHART* for detailed information.

$V_{IN} = 1.8$ to $5.5V$, $I_{OUT} = 1mA$, $C_{IN} = 1\mu F$, $C_{OUT} = \text{None}$, unless otherwise noted.

The specifications surrounded by are guaranteed by design engineering at $-40^{\circ}C \leq T_a \leq 85^{\circ}C$.

R5527K001D

(Ta=25°C)

Symbol	Item	Conditions	Min.	Typ.	Max.	Unit	
V_{IN}	Input Voltage		1.8		5.5	V	
I_{SD}	Shutdown Current	$V_{ON}=GND$, $V_{OUT}=GND$	$T_a=25^{\circ}C$		0.5	1	μA
			$T_a=85^{\circ}C$		0.5	10	μA
I_Q	Quiescent Current	$V_{ON}=V_{IN}$, $I_{OUT}=0mA$		40	70	μA	
R_{ON}	On Resistance	$V_{IN}=5V$, $I_{OUT}=1A$		48	65	m Ω	
		$V_{IN}=4.5V$, $I_{OUT}=1A$		46			
		$V_{IN}=3.8V$, $I_{OUT}=1A$		45	60		
		$V_{IN}=3.3V$, $I_{OUT}=500mA$		45			
		$V_{IN}=2.5V$, $I_{OUT}=500mA$		51			
		$V_{IN}=1.8V$, $I_{OUT}=250mA$		68			
V_{IH}	ON Input Logic High Voltage	$V_{IN}=1.8V$ to $5.5V$	1.7			V	
V_{IL}	ON Input Logic Low Voltage	$V_{IN}=1.8V$ to $5.5V$			1.2	V	
I_{ON}	ON Input Leakage	$V_{ON}=GND$			1	μA	
R_{ON_PD}	Pull-Down Resistance at ON Pin	$V_{IN}=V_{ON}=1.8V$ to $5.5V$		3		M Ω	
V_{T_RCB}	RCB Protection Trip Point	$V_{OUT} - V_{IN}$		45		mV	
V_{R_RCB}	RCB Protection Release Trip Point	$V_{IN} - V_{OUT}$		25		mV	
	RCB Hysteresis			70		mV	
I_{SD_OUT}	V_{OUT} Shutdown Current	$V_{ON}=GND$, $V_{OUT}=5.5V$, $V_{IN}=\text{Short to GND}$			10	μA	
t_{DON}^{*1}	Turn-On Delay	$V_{IN}=3.8V$, $R_L=150\Omega$, $C_L=100\mu F$ Time from ON="L"→"H" to $V_{OUT}=V_{IN} \times 10\%$	0.5		2.5	ms	
t_R^{*1}	V_{OUT} Rise Time	$V_{IN}=3.8V$, $R_L=150\Omega$, $C_L=100\mu F$ Time from $V_{OUT}=V_{IN} \times 10\%$ to $V_{IN} \times 90\%$	1.5		5.0	ms	
t_{ON}^{*1}	Turn-On Time	$V_{IN}=3.8V$, $R_L=150\Omega$, $C_L=100\mu F$ Time from ON="L"→"H" to $V_{OUT}=V_{IN} \times 90\%$	2.0		7.5	ms	
R_{LOW}	Nch. On Resistance for Auto-Discharge	$V_{IN}=5.0V$, $V_{ON}=GND$, $V_{OUT}=0.1V$		20		Ω	

All test items listed under *ELECTRICAL CHARACTERISTICS* are done under the pulse load condition ($T_j \approx T_a = 25^{\circ}C$) except RCB Protection Trip Point, RCB Protection Release Trip Point, and RCB Hysteresis.

*1 Refer to the *TIMING CHART* for detailed information.

TYPICAL APPLICATION

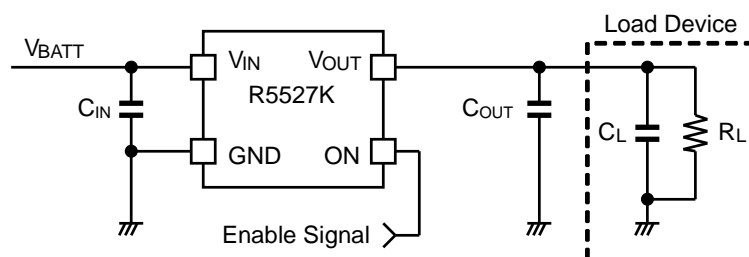

R5527K Typical Application

TECHNICAL NOTES

- Basically, the R5527K does not require a bypass capacitor between V_{IN} and GND, however, considering the spike noise, use 0.1 μ F or more capacitor (1 μ F [Ceramic] recommended) as a bypass capacitor. More capacitance is also acceptable depending on the application.
- When a voltage is remained in the output pin at the restart, the startup time (the time until R5527K is able to fully drive the output load from ON signal input) takes longer than the t_{ON} definition. Refer to the following graph for the maximum value of the startup time. When returning from the reverse current blocking (RCB) trip point, the following startup time is necessary based on the RCB protection release trip point.

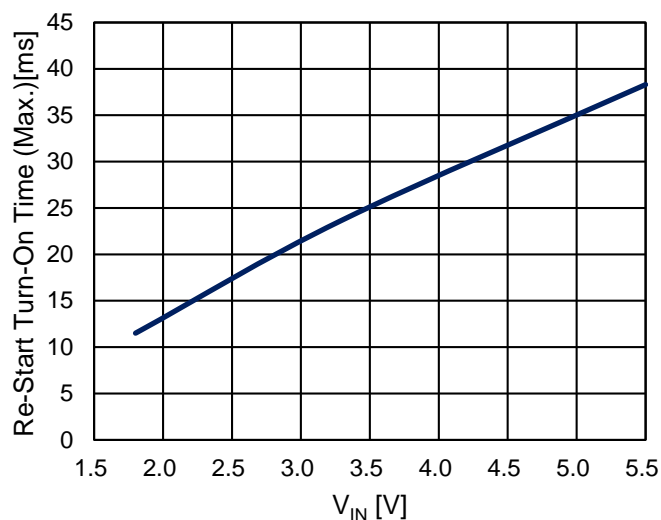

TIMING CHART

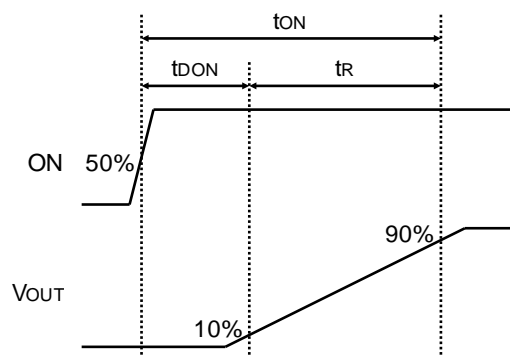
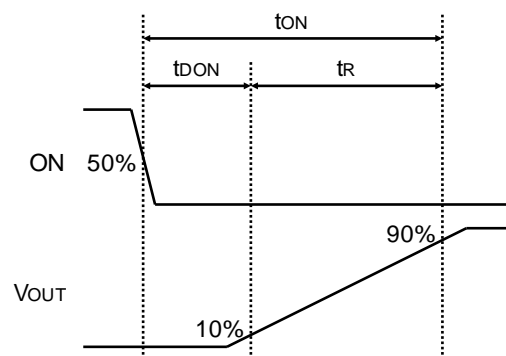
**V_{OUT} Timing Chart (R5527K001B/D)****V_{OUT} Timing Chart (R5527K001A/C)**

PACKAGE INFORMATION

Power Dissipation (DFN(PLP)1612-4D)

Power Dissipation (P_D) depends on conditions of mounting on board. This specification is based on the measurement at the condition below:

Measurement Conditions

	Standard Test Land Pattern
Environment	Mounting on Board (Wind velocity=0m/s)
Board Material	Glass cloth epoxy plastic (Double sided)
Board Dimensions	40mm*40mm*1.6mm
Copper Ratio	Top side: Approx. 50%, Back side: Approx. 50%
Through-holes	ϕ 0.54mm * 24pcs

Measurement Result

($T_a=25^\circ\text{C}$, $T_{j\text{max}}=125^\circ\text{C}$)

	Standard Test Land Pattern
Power Dissipation	610mW
Thermal Resistance	$\theta_{ja} = (125-25^\circ\text{C})/0.61\text{W} = 164^\circ\text{C/W}$
	$\theta_{jc} = 48^\circ\text{C/W}$

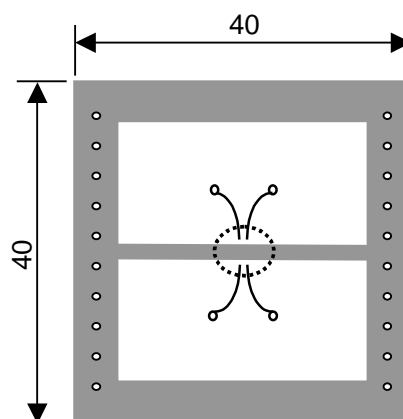
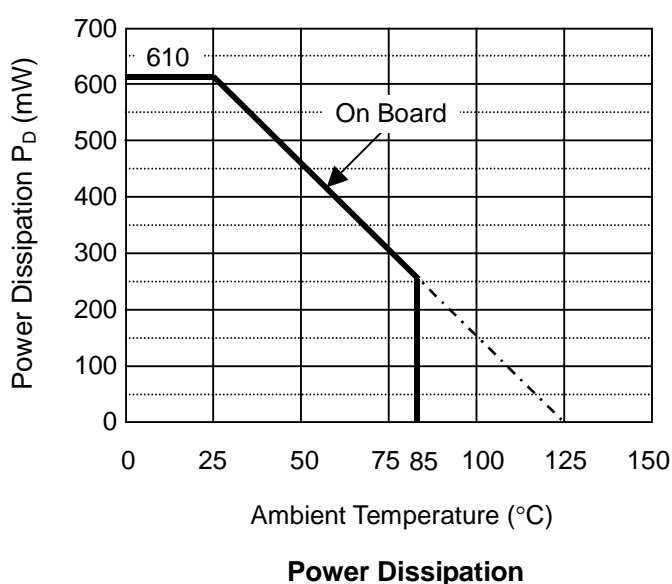

Measurement Board Pattern

 IC Mount Area (Unit : mm)

Package Dimensions (DFN(PLP)1612-4D)

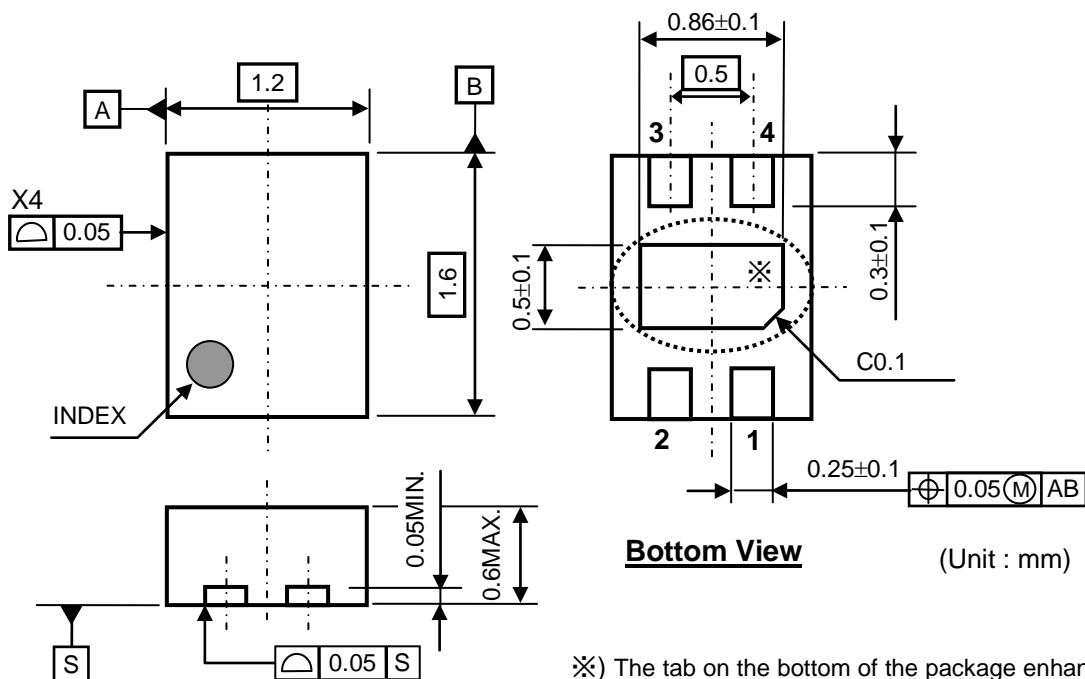

Bottom View

(Unit : mm)

※) The tab on the bottom of the package enhances thermal performance and is electrically connected to GND (substrate level). It is recommended that the tab be connected to the ground plane on the board, or otherwise be left floating.

Mark Specification (DFN(PLP)1612-4D)

- ①②: Product Code ... Refer to "R5527K Mark Specification Table".
- ③④: Lot Number ... Alphanumeric Serial Number

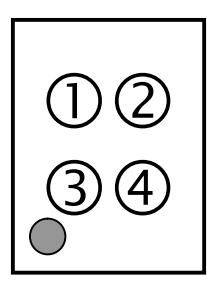

Mark Specification

R5527K Mark Specification Table (DFN(PLP)1612-4D)

Product Name	①②
R5527K001B	7A
R5527K001C	7B
R5527K001D	7C
R5527K001A	7D

TYPICAL CHARACTERISTICS

Note: Typical Characteristics are intended to be used as reference data; they are not guaranteed.

1) On Resistance vs. Input Voltage

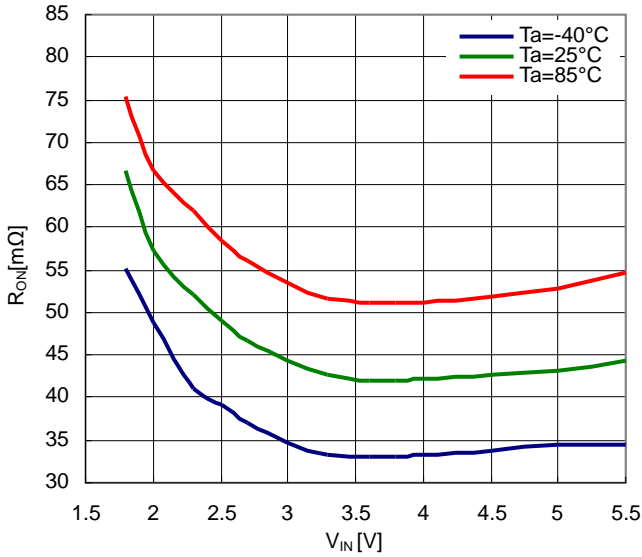

2) On Resistance vs. Temperature

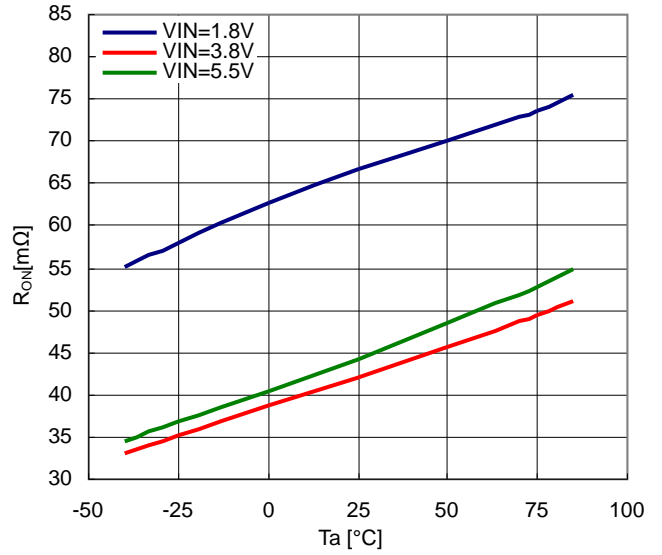

3) Off Supply Current vs. Input Voltage

R5527K001B/R5527K001D

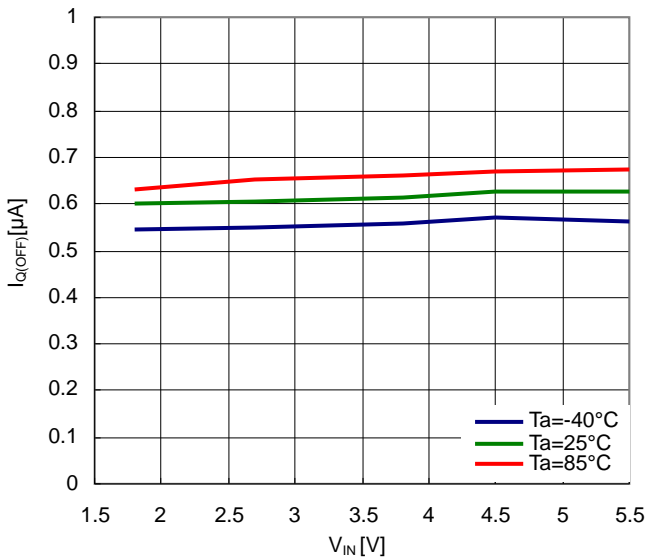

4) Off Supply Current vs. Temperature

R5527K001B/R5527K001D

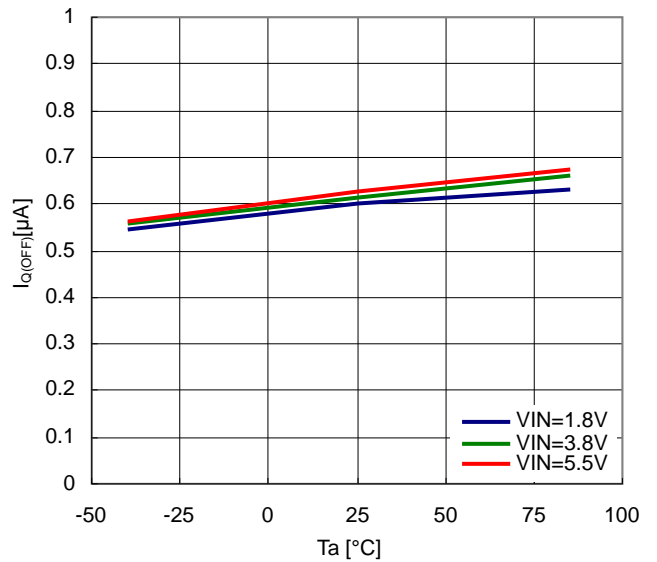

5) ON pin Pull-Down Current vs. Input Voltage

R5527K001B/R5527K001D

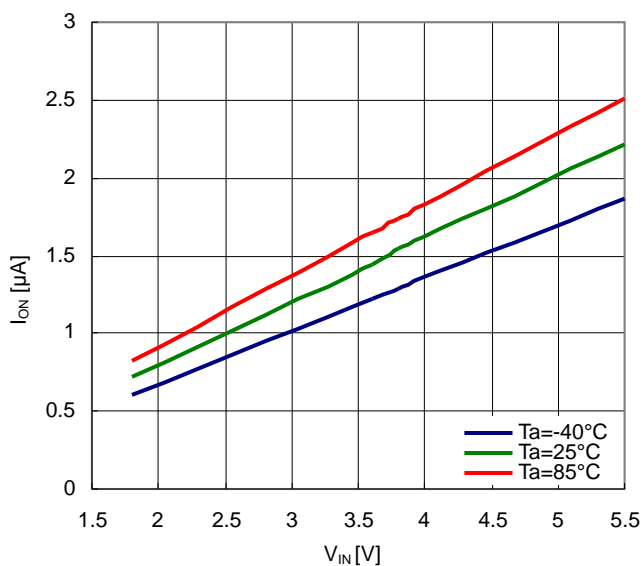

6) ON pin Pull-Down Current vs. Temperature

R5527K001B/R5527K001D

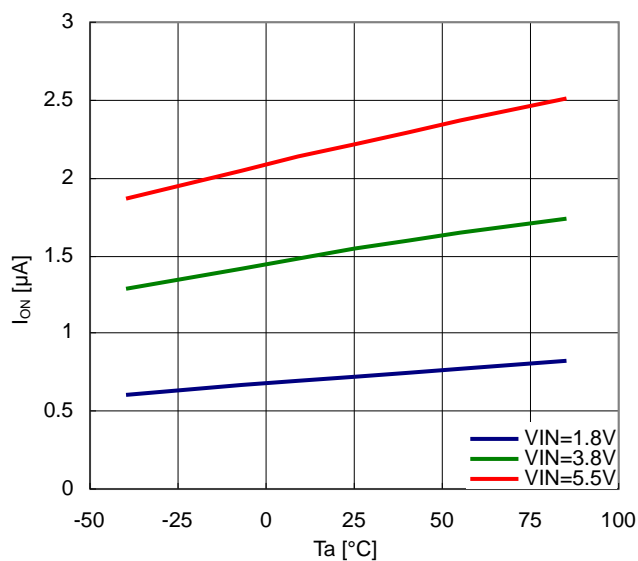

7) ON pin Logic Threshold vs. Input Voltage

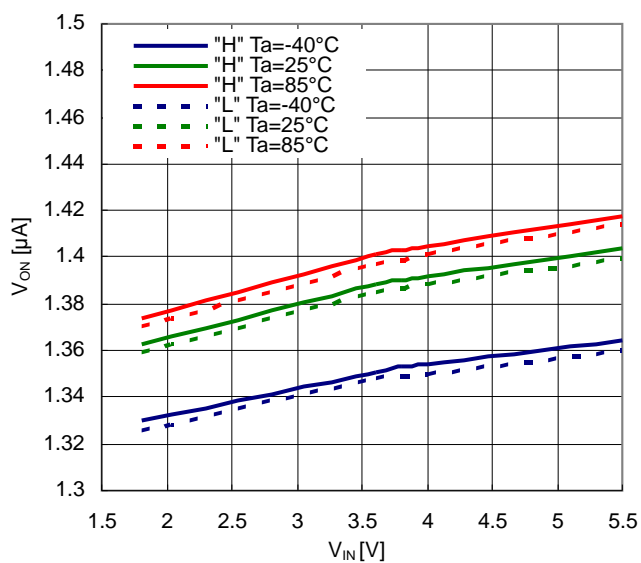

8) ON pin Logic Threshold vs. Temperature

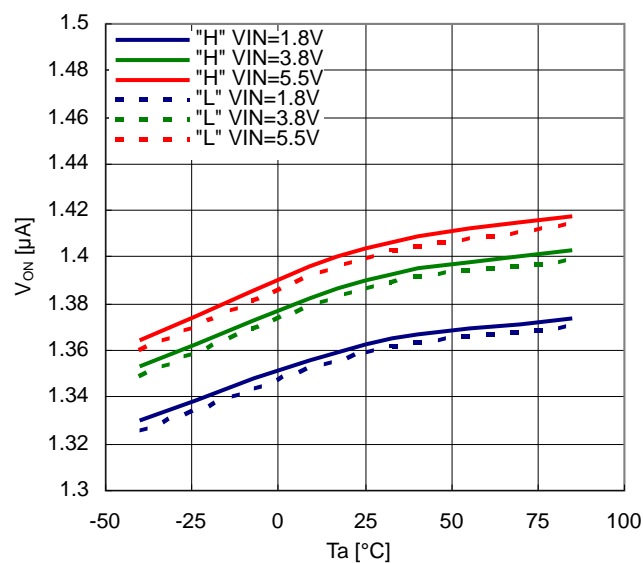

9) Quiescent Current vs. Input Voltage

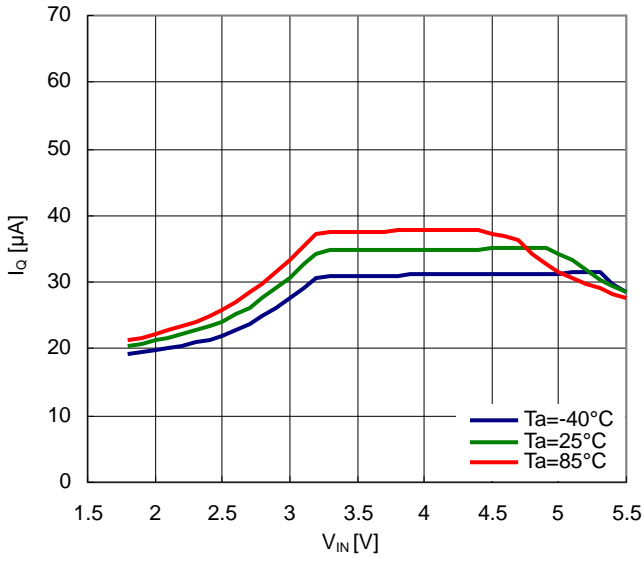

10) Quiescent Current vs. Temperature

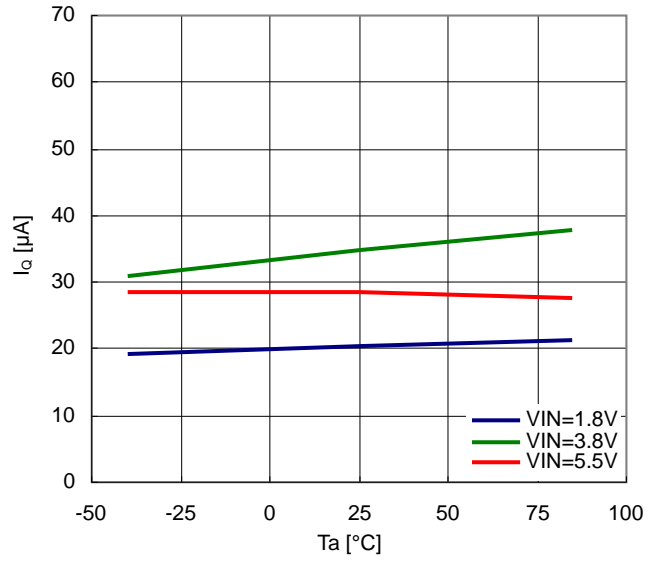

11) Off Supply Current vs. Input Voltage
R5527K001A/R5527K001C

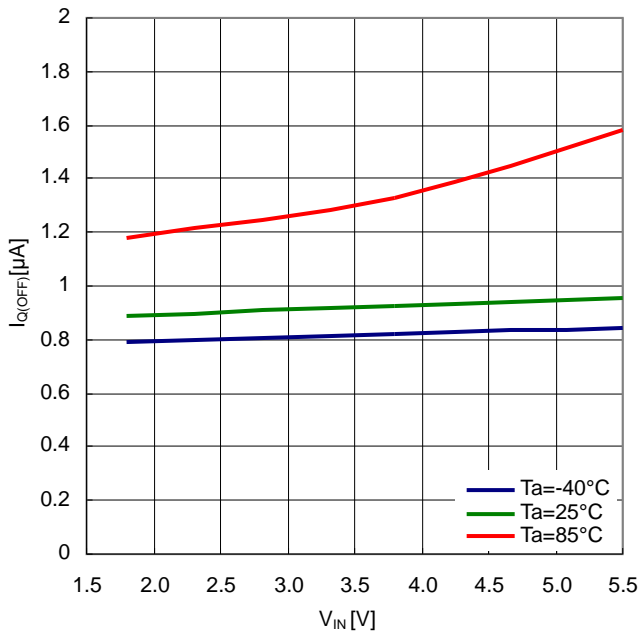

12) Off Supply Current vs. Temperature
R5527K001A/R5527K001C

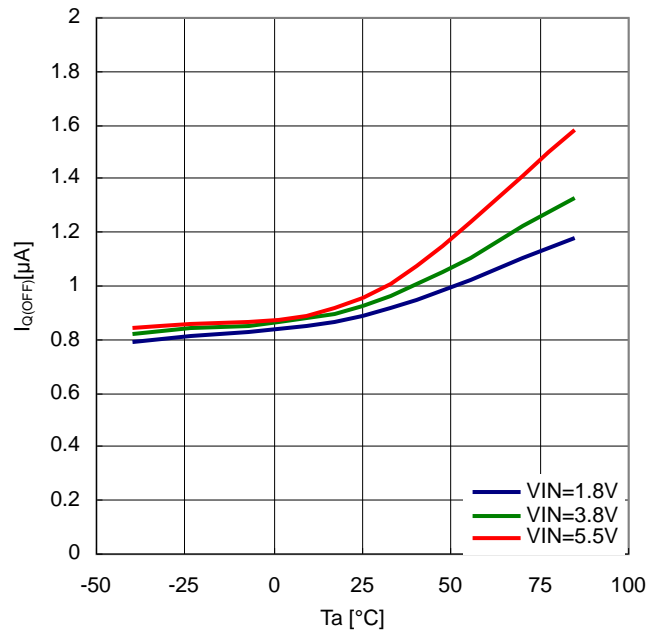

13) Inrush Current

R5527K001B

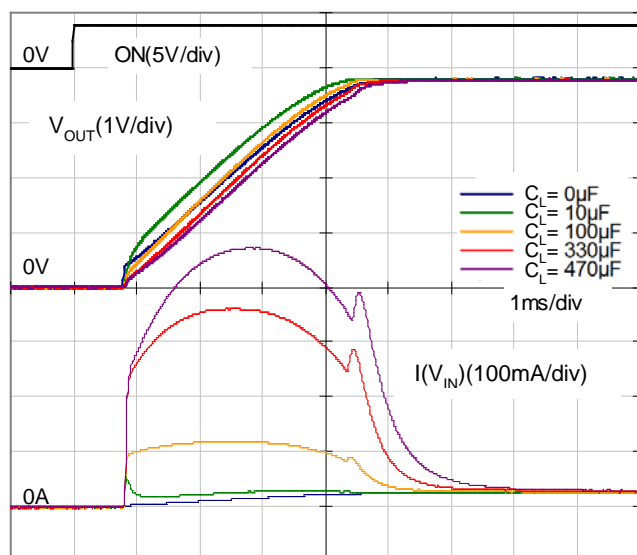
Ta=25°C R_L=150Ω



1. The products and the product specifications described in this document are subject to change or discontinuation of production without notice for reasons such as improvement. Therefore, before deciding to use the products, please refer to Ricoh sales representatives for the latest information thereon.
2. The materials in this document may not be copied or otherwise reproduced in whole or in part without prior written consent of Ricoh.
3. Please be sure to take any necessary formalities under relevant laws or regulations before exporting or otherwise taking out of your country the products or the technical information described herein.
4. The technical information described in this document shows typical characteristics of and example application circuits for the products. The release of such information is not to be construed as a warranty of or a grant of license under Ricoh's or any third party's intellectual property rights or any other rights.
5. The products listed in this document are intended and designed for use as general electronic components in standard applications (office equipment, telecommunication equipment, measuring instruments, consumer electronic products, amusement equipment etc.). Those customers intending to use a product in an application requiring extreme quality and reliability, for example, in a highly specific application where the failure or misoperation of the product could result in human injury or death (aircraft, spacevehicle, nuclear reactor control system, traffic control system, automotive and transportation equipment, combustion equipment, safety devices, life support system etc.) should first contact us.
6. We are making our continuous effort to improve the quality and reliability of our products, but semiconductor products are likely to fail with certain probability. In order to prevent any injury to persons or damages to property resulting from such failure, customers should be careful enough to incorporate safety measures in their design, such as redundancy feature, fire containment feature and fail-safe feature. We do not assume any liability or responsibility for any loss or damage arising from misuse or inappropriate use of the products.
7. Anti-radiation design is not implemented in the products described in this document.
8. Please contact Ricoh sales representatives should you have any questions or comments concerning the products or the technical information.



Ricoh is committed to reducing the environmental loading materials in electrical devices with a view to contributing to the protection of human health and the environment.

Ricoh has been providing RoHS compliant products since April 1, 2006 and Halogen-free products since April 1, 2012.

RICOH RICOH ELECTRONIC DEVICES CO., LTD.

<http://www.e-devices.ricoh.co.jp/en/>

Sales & Support Offices

RICOH ELECTRONIC DEVICES CO., LTD.

Higashi-Shinagawa Office (International Sales)
3-32-3, Higashi-Shinagawa, Shinagawa-ku, Tokyo 140-8655, Japan
Phone: +81-3-5479-2857 Fax: +81-3-5479-0502

RICOH EUROPE (NETHERLANDS) B.V.

Semiconductor Support Centre
Prof. W.H. Keesomlaan 1, 1183 DJ Amstelveen, The Netherlands
Phone: +31-20-5474-309

RICOH ELECTRONIC DEVICES KOREA CO., LTD.

3F, Haesung Bldg. 504, Teheran-ro, Gangnam-gu, Seoul, 135-725, Korea
Phone: +82-2-2135-5700 Fax: +82-2-2051-5713

RICOH ELECTRONIC DEVICES SHANGHAI CO., LTD.

Room 403, No.2 Building, No.690 Bilbo Road, Pu Dong New District, Shanghai 201203,
People's Republic of China
Phone: +86-21-5027-3200 Fax: +86-21-5027-3299

RICOH ELECTRONIC DEVICES CO., LTD.

Taipei office
Room 109, 10F-1, No.51, Hengyang Rd., Taipei City, Taiwan (R.O.C.)
Phone: +886-2-2313-1621/1622 Fax: +886-2-2313-1623

Mouser Electronics

Authorized Distributor

Click to View Pricing, Inventory, Delivery & Lifecycle Information:

[Ricoch Electronics:](#)

[R5527K001D-TR](#) [R5527K001B-TR](#) [R5527K001C-TR](#)



Стандарт Электрон Связь

Мы молодая и активно развивающаяся компания в области поставок электронных компонентов. Мы поставляем электронные компоненты отечественного и импортного производства напрямую от производителей и с крупнейших складов мира.

Благодаря сотрудничеству с мировыми поставщиками мы осуществляем комплексные и плановые поставки широчайшего спектра электронных компонентов.

Собственная эффективная логистика и склад в обеспечивает надежную поставку продукции в точно указанные сроки по всей России.

Мы осуществляем техническую поддержку нашим клиентам и предпродажную проверку качества продукции. На все поставляемые продукты мы предоставляем гарантию .

Осуществляем поставки продукции под контролем ВП МО РФ на предприятия военно-промышленного комплекса России , а также работаем в рамках 275 ФЗ с открытием отдельных счетов в уполномоченном банке. Система менеджмента качества компании соответствует требованиям ГОСТ ISO 9001.

Минимальные сроки поставки, гибкие цены, неограниченный ассортимент и индивидуальный подход к клиентам являются основой для выстраивания долгосрочного и эффективного сотрудничества с предприятиями радиоэлектронной промышленности, предприятиями ВПК и научно-исследовательскими институтами России.

С нами вы становитесь еще успешнее!

Наши контакты:

Телефон: +7 812 627 14 35

Электронная почта: sales@st-electron.ru

Адрес: 198099, Санкт-Петербург,
Промышленная ул, дом № 19, литера Н,
помещение 100-Н Офис 331