

Low-Power 2.25V to 3.63V DC to 150MHz 1:4 Fanout Buffer IC

FEATURES

- 1:4 LVCMOS output fanout buffer for DC to 150MHz
- Low Additive Phase Jitter of 60fs RMS
- 8mA Output Drive Strength
- Low power consumption for portable applications
- Low input-output delay
- Output-Output skew less than 250ps
- 2.5V to 3.3V, $\pm 10\%$ operation
- Operating temperature range from -40°C to 85°C
- Available in 8-Pin SOP GREEN/RoHS package

DESCRIPTION

The PL133-47 is an advanced fanout buffer design for high performance, low-power, small form factor applications. The PL133-47 accepts a reference clock input from DC to 150MHz and provides 4 outputs of the same frequency.

The PL133-47 is offered in a SOP-8L package and it offers the best phase noise, additive jitter performance, and lowest power consumption of any comparable IC.

BLOCK DIAGRAM AND PACKAGE PINOUT

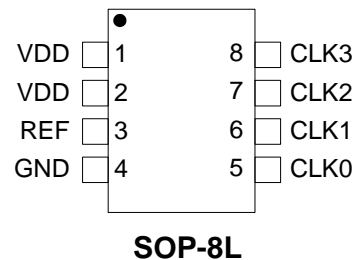
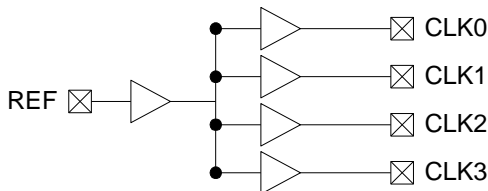

Low-Power 2.25V to 3.63V DC to 150MHz 1:4 Fanout Buffer IC
PIN DESCRIPTIONS

Name	SOP-8L	Type	Description
REF	3	I	Input reference frequency.
CLK0	5	O	Buffered clock output
CLK1	6	O	Buffered clock output
CLK2	7	O	Buffered clock output
CLK3	8	O	Buffered clock output
VDD	1, 2	P	VDD connection
GND	4	P	GND connection

LAYOUT RECOMMENDATIONS

The following guidelines are to assist you with a performance optimized PCB design:

Signal Integrity and Termination Considerations

- Keep traces short!
- Trace = Inductor. With a capacitive load this equals ringing!
- Long trace = Transmission Line. Without proper termination this will cause reflections (looks like ringing).
- Design long traces (> 1 inch) as "striplines" or "microstrips" with defined impedance.
- Match trace at one side to avoid reflections bouncing back and forth.

Decoupling and Power Supply Considerations

- Place decoupling capacitors as close as possible to the VDD pin(s) to limit noise from the power supply
- Addition of a ferrite bead in series with VDD can help prevent noise from other board sources
- Value of decoupling capacitor is frequency dependant. Typical values to use are 0.1 μ F for designs using frequencies < 50MHz and 0.01 μ F for designs using frequencies > 50MHz.

Typical CMOS termination

Place Series Resistor as close as possible to CMOS output

CMOS Output Buffer
(Typical buffer impedance 20 ohm)

To CMOS Input

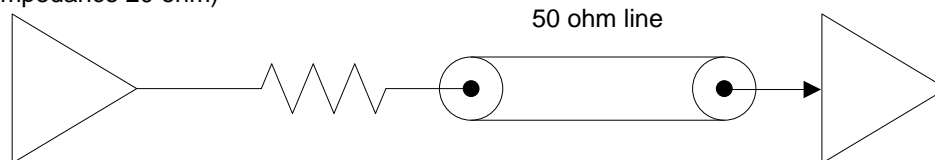

Connect a 33 ohm series resistor at each of the output clocks to enhance the stability of the output signal

Low-Power 2.25V to 3.63V DC to 150MHz 1:4 Fanout Buffer IC
ABSOLUTE MAXIMUM CONDITIONS

Supply Voltage to Ground Potential -0.5V to 4.6V
 DC Input Voltage $V_{SS} - 0.5V$ to 4.6V
 Storage Temperature -65°C to 150°C

Junction Temperature..... 150°C
 Static Discharge Voltage
 (per MIL-STD-883, Method 3015)..... > 2000V

OPERATING CONDITIONS

Parameter	Description	Min.	Max.	Unit
V_{DD}	Supply Voltage	2.25	3.63	V
T_A	Commercial Operating Temperature (ambient temperature)	0	70	°C
	Industrial Operating Temperature (ambient temperature)	-40	85	°C
C_L	Load Capacitance, below 100 MHz	—	30	pF
	Load Capacitance between 100 MHz and 134 MHz	—	10	pF
	Load Capacitance, above 134 MHz	—	5	pF
C_{IN}	Input Capacitance	—	7	pF
REF, CLK[1:6]	Operating Frequency, Input=Output	DC	150	MHz
t_{PU}	Power-up time for all V_{DD} s to reach minimum specified voltage (power ramps must be monotonic)	0.05	50	ms

ELECTRICAL CHARACTERISTICS (Commercial and Industrial Temperature Devices)

Parameter	Description	Test Conditions	Min.	Max.	Unit
V_{IL}	Input LOW Voltage ^[1]		—	0.8	V
V_{IH}	Input HIGH Voltage ^[1]		2.0	—	V
I_{IL}	Input LOW Current	$V_{IN} = 0V$	—	50	μA
I_{IH}	Input HIGH Current	$V_{IN} = V_{DD}$	—	100	μA
V_{OL}	Output LOW Voltage ^[2]	$I_{OL} = 8\text{ mA}$	—	0.4	V
V_{OH}	Output HIGH Voltage ^[2]	$I_{OH} = -8\text{ mA}$	2.4	—	V
I_{DD}	Supply Current	66.67MHz with unloaded outputs	—	32	mA

Low-Power 2.25V to 3.63V DC to 150MHz 1:4 Fanout Buffer IC

SWITCHING CHARACTERISTICS (Commercial and Industrial Temperature Devices) ^[3]

Parameter	Description	Test Conditions	Min.	Typ.	Max.	Unit
	Duty Cycle ^[2] = $t_2 \div t_1$	Measured at 1.4V, Input is 50%	40	50	60	%
t_3	Rise Time ^[2]	Measured between 0.8V and 2.0V	–	–	1.5	ns
t_4	Fall Time ^[2]	Measured between 0.8V and 2.0V	–	–	1.5	ns
t_5	Output to Output Skew ^[2]	All outputs equally loaded	–	–	250	ps
t_6	Propagation Delay, REF Rising Edge to CLKX Rising Edge ^[2]	Measured at $V_{DD}/2$	1	5	9.2	ns

Notes:

1. REF input has a threshold voltage of $V_{DD}/2$
2. Parameter is guaranteed by design and characterization. Not 100% tested in production.
3. All parameters are specified with loaded outputs.

NOISE CHARACTERISTICS (Commercial and Industrial Temperature Devices)

Parameter	Description	Test Conditions	Min.	Typ.	Max.	Unit
	Additive Phase Jitter	$V_{DD}=3.3V$, Frequency=100MHz Offset=12KHz ~ 20MHz		60		fs

PL133-47 Additive Phase Jitter:
V_{DD}=3.3V, CLK=100MHz, Integration Range 12KHz to 20MHz: 0.059ps typical.

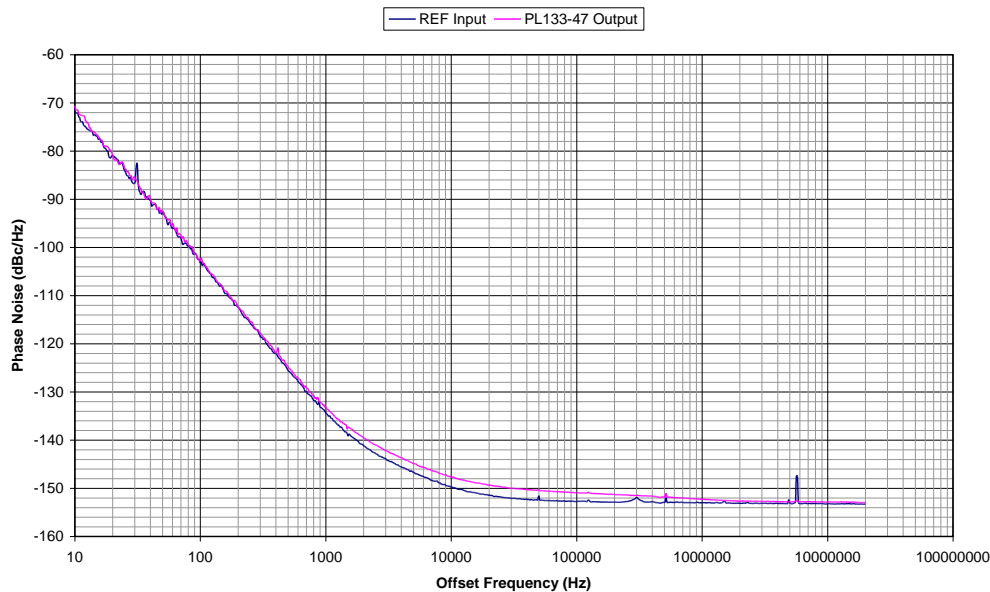

When a buffer is used to pass a signal then the buffer will add a little bit of its own noise. The phase noise on the output of the buffer will be a little bit more than the phase noise in the input signal. To quantify the noise addition in the buffer we compare the Phase Jitter numbers from the input and the output. The difference is called "Additive Phase Jitter". The formula for the Additive Phase Jitter is as follows:

$$\text{Additive Phase Jitter} = \sqrt{(\text{Output Phase Jitter})^2 - (\text{Input Phase Jitter})^2}$$

Low-Power 2.25V to 3.63V DC to 150MHz 1:4 Fanout Buffer IC

SWITCHING WAVEFORMS

Duty Cycle Timing

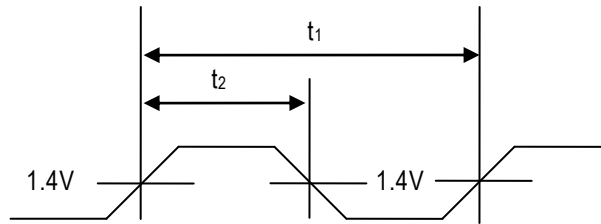

All Outputs Rise/Fall Time

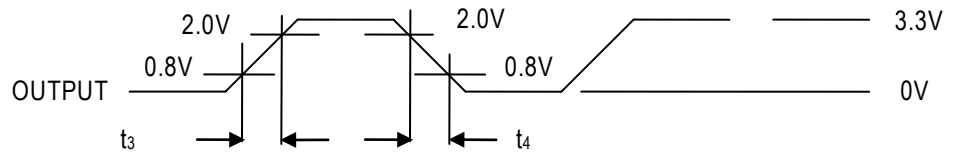

Output-Output Skew

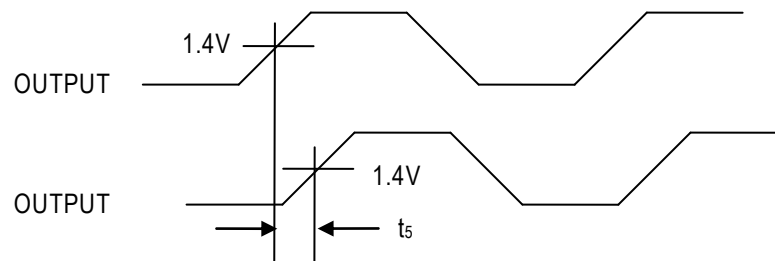

Input-Output Propagation Delay

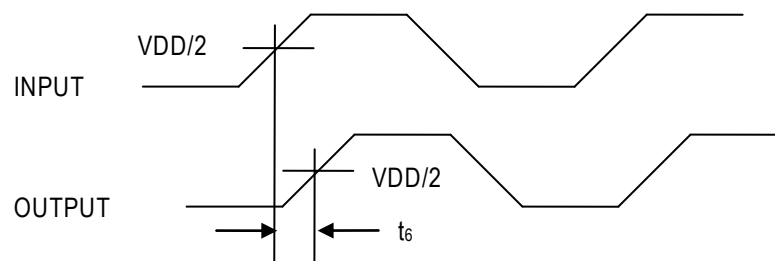

TEST CIRCUIT

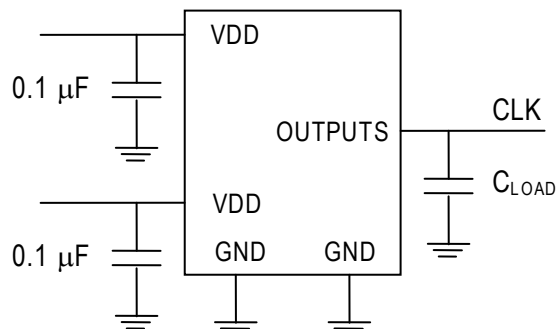

Low-Power 2.25V to 3.63V DC to 150MHz 1:4 Fanout Buffer IC

PACKAGE DRAWING (GREEN PACKAGE COMPLIANT)

SOP 8L

Symbol	Dimension in MM	
	Min.	Max.
A	1.35	1.75
A1	0.10	0.25
A2	1.25	1.50
B	0.33	0.53
C	0.19	0.27
D	4.80	5.00
E	3.80	4.00
H	5.80	6.20
L	0.40	0.89
e	1.27 BSC	

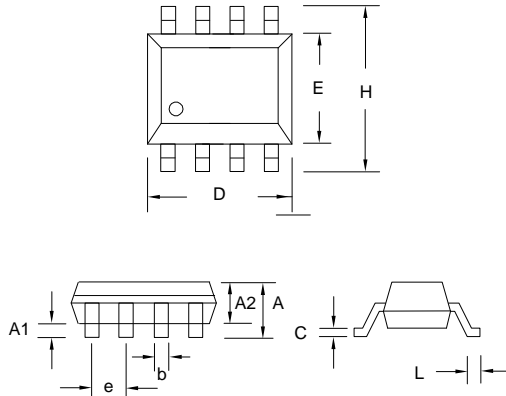

Low-Power 2.25V to 3.63V DC to 150MHz 1:4 Fanout Buffer IC

ORDERING INFORMATION

For part ordering, please contact our Sales Department:

2180 Fortune Drive, San Jose, CA 95131, USA

Tel: (408) 944-0800 Fax: (408) 474-1000

PART NUMBER

The order number for this device is a combination of the following:
Part number, Package type and Operating temperature range

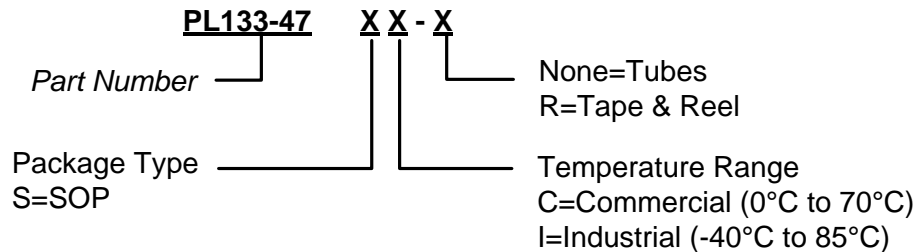

Part/Order Number	Marking	Package Option
Green (Lead-Free) Package		
PL133-47SC	P133-47 SC	8-Pin SOP Tube
PL133-47SC-R	LLLLL	8-Pin SOP (Tape and Reel)
PL133-47SI	P133-47 SI	8-Pin SOP Tube
PL133-47SI-R	LLLLL	8-Pin SOP (Tape and Reel)

*Note: LLLLL designates lot number

Micrel Inc., reserves the right to make changes in its products or specifications, or both at any time without notice. The information furnished by Micrel is believed to be accurate and reliable. However, Micrel makes no guarantee or warranty concerning the accuracy of said information and shall not be responsible for any loss or damage of whatever nature resulting from the use of, or reliance upon this product.

LIFE SUPPORT POLICY: Micrel's products are not authorized for use as critical components in life support devices or systems without the express written approval of the President of Micrel Inc.



Стандарт Электрон Связь

Мы молодая и активно развивающаяся компания в области поставок электронных компонентов. Мы поставляем электронные компоненты отечественного и импортного производства напрямую от производителей и с крупнейших складов мира.

Благодаря сотрудничеству с мировыми поставщиками мы осуществляем комплексные и плановые поставки широчайшего спектра электронных компонентов.

Собственная эффективная логистика и склад в обеспечивает надежную поставку продукции в точно указанные сроки по всей России.

Мы осуществляем техническую поддержку нашим клиентам и предпродажную проверку качества продукции. На все поставляемые продукты мы предоставляем гарантию .

Осуществляем поставки продукции под контролем ВП МО РФ на предприятия военно-промышленного комплекса России , а также работаем в рамках 275 ФЗ с открытием отдельных счетов в уполномоченном банке. Система менеджмента качества компании соответствует требованиям ГОСТ ISO 9001.

Минимальные сроки поставки, гибкие цены, неограниченный ассортимент и индивидуальный подход к клиентам являются основой для выстраивания долгосрочного и эффективного сотрудничества с предприятиями радиоэлектронной промышленности, предприятиями ВПК и научно-исследовательскими институтами России.

С нами вы становитесь еще успешнее!

Наши контакты:

Телефон: +7 812 627 14 35

Электронная почта: sales@st-electron.ru

Адрес: 198099, Санкт-Петербург,
Промышленная ул, дом № 19, литера Н,
помещение 100-Н Офис 331