

**DATA SHEET**

# SKY67106-306LF: 1.5-3.0 GHz Two-Stage, High Linearity and High Gain Low-Noise Amplifier

## Applications

- CDMA, WCDMA, TD-SCDMA, WiMAX, and LTE cellular infrastructure systems
- Ultra low-noise, high gain and high linearity systems

## Features

- Ultra-low NF: 0.65 dB @ 1950 MHz
- High gain: 35 dB @ 1950 MHz
- Low quiescent current: 100 mA
- Stage 1 adjustable gain and current
- Wideband performance, useable to 3 GHz
- Small, QFN (16-pin, 4 x 4 mm) Pb-free package (MSL1, 260 °C per JEDEC J-STD-020)



Skyworks Green™ products are compliant with all applicable legislation and are halogen-free. For additional information, refer to *Skyworks Definition of Green™*, document number SQ04-0074.

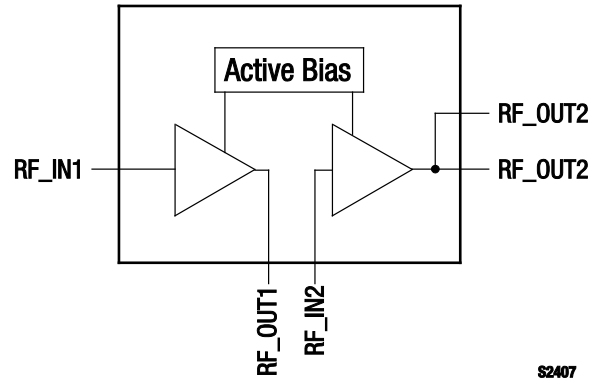

**Figure 1. SKY67106-306LF Block Diagram**

## Description

The SKY67106-306LF is a GaAs pHEMT and HBT two-stage, Low-Noise Amplifier (LNA) with active bias and high linearity performance. The pHEMT front end of the device provides an ultra-low Noise Figure (NF) while the HBT output stage provides high gain, linearity, and efficiency.

The SKY67106-306LF operates in the frequency range of 1.5 to 3.0 GHz. For lower frequency operation, the pin and layout-compatible SKY67105-306LF (Data Sheet document # 201518) should be used.

The SKY67106-306LF is provided in a 4 x 4 mm, 16-pin Quad Flat No-Lead (QFN) package. A functional block diagram is shown in Figure 1. The pin configuration and package are shown in Figure 2. Signal pin assignments and functional pin descriptions are provided in Table 1.

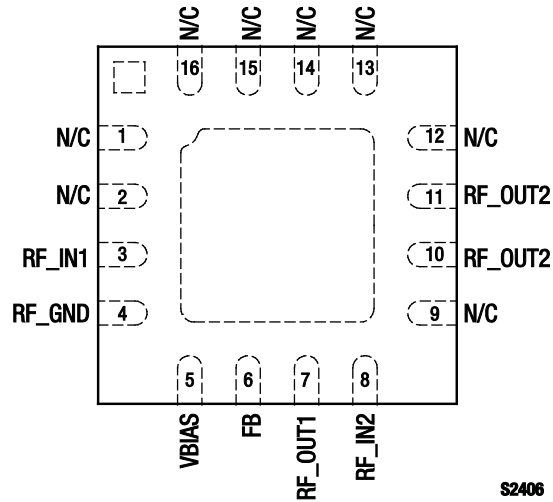

**Figure 2. SKY67106-306LF Pinout – 16-Pin QFN (Top View)**

**Table 1. SKY67106-306LF Signal Descriptions**

Pin #	Name	Description	Pin #	Name	Description
1	N/C	No connection. May be grounded with no change in performance.	9	N/C	No connection. May be grounded with no change in performance.
2	N/C	No connection. May be grounded with no change in performance.	10	RF_OUT2	RF output of second stage amplifier
3	RF_IN1	RF input to first stage amplifier	11	RF_OUT2	RF output of second stage amplifier
4	RF_GND	RF ground for first stage amplifier	12	N/C	No connection. May be grounded with no change in performance.
5	VBIAS	Bias for first stage amplifier. External resistor sets current consumption.	13	N/C	No connection. May be grounded with no change in performance.
6	FB	Feedback pin for first stage amplifier.	14	N/C	No connection. May be grounded with no change in performance.
7	RF_OUT1	RF output of first stage amplifier	15	N/C	No connection. May be grounded with no change in performance.
8	RF_IN2	RF input to second stage amplifier	16	N/C	No connection. May be grounded with no change in performance.

**Electrical and Mechanical Specifications**

The absolute maximum ratings of the SKY67106-306LF are provided in Table 2. Electrical specifications are provided in Table 3 (1950 MHz) and Table 4 (2600 MHz).

Typical performance characteristics of the SKY67106-306LF are illustrated in Figures 3 through 15 (1950 MHz) and in Figures 16 through 28 (2600 MHz).

**Table 2. SKY67106-306LF Absolute Maximum Ratings**

Parameter	Symbol	Minimum	Maximum	Units
Supply voltage	V <sub>DD</sub>		5.5	V
RF input power	P <sub>IN</sub>		+15	dBm
Operating temperature	T <sub>OP</sub>	-40	+85	°C
Storage temperature	T <sub>STG</sub>	-40	+125	°C
Junction temperature	T <sub>J</sub>		+150	°C
Thermal resistance	Θ <sub>JC</sub>		85	°C/W

**Note:** Exposure to maximum rating conditions for extended periods may reduce device reliability. There is no damage to device with only one parameter set at the limit and all other parameters set at or below their nominal value. Exceeding any of the limits listed here may result in permanent damage to the device.

**CAUTION:** Although this device is designed to be as robust as possible, Electrostatic Discharge (ESD) can damage this device. This device must be protected at all times from ESD. Static charges may easily produce potentials of several kilovolts on the human body or equipment, which can discharge without detection. Industry-standard ESD precautions should be used at all times. The SKY67106-306LF is a Class 1B ESD device.

**Table 3. SKY67106-306LF Electrical Specifications (Note 1)**

(V<sub>DD</sub> = +5 V, T<sub>OP</sub> = +25 °C, P<sub>IN</sub> = -30 dBm, Characteristic Impedance [Z<sub>0</sub>] = 50 Ω, Optimized for 1950 MHz Operation, Unless Otherwise Noted)

Parameter	Symbol	Test Condition	Min	Typical	Max	Units
<b>RF Specifications</b>						
Noise Figure	NF	@ 1950 MHz		0.65	0.87	dB
Small signal gain	IS21I	@ 1950 MHz	32.5	35.0		dB
Input return loss	IS11I	@ 1950 MHz	10	14		dB
Output return loss	IS22I	@ 1950 MHz	15	22		dB
Reverse isolation	IS12I	@ 1950 MHz	50	55		dB
3 <sup>rd</sup> Order Input Intercept Point	IIP3	@ 1950 MHz, Δf = 1 MHz, P <sub>IN</sub> = -30 dBm/tone	0	+2.5		dBm
3 <sup>rd</sup> Order Output Intercept Point	OIP3	@ 1950 MHz, Δf = 1 MHz, P <sub>IN</sub> = -30 dBm/tone	+34.5	+37.0		dBm
1 dB Input Compression Point	IP1dB	@ 1950 MHz	-11	-9		dBm
1 dB Output Compression Point	OP1dB	@ 1950 MHz	+22	+24		dBm
<b>DC Specifications</b>						
Supply voltage	V <sub>DD</sub>		3.5	5.0	5.5	V
Quiescent current	I <sub>DD</sub>	Set with external resistor		100	125	mA
Supply current @ IP1dB	I <sub>DD_IP1DB</sub>	Set with external resistor		160	190	mA

**Note 1:** Performance is guaranteed only under the conditions listed in this Table.

### Typical Performance Characteristics (1950 MHz)

( $V_{DD} = +5\text{ V}$ ,  $T_{OP} = +25\text{ }^{\circ}\text{C}$ ,  $P_{IN} = -30\text{ dBm}$ , Characteristic Impedance [ $Z_0$ ] =  $50\text{ }\Omega$ , Optimized for 1950 MHz Operation, Unless Otherwise Noted)

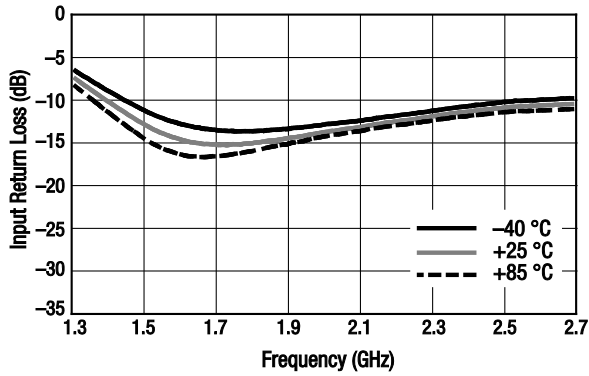

Figure 3. Input Return Loss vs Frequency Over Temperature, Narrow Band

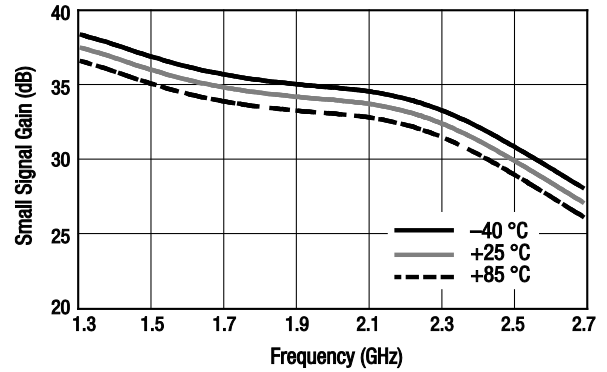

Figure 4. Small Signal Gain vs Frequency Over Temperature, Narrow Band

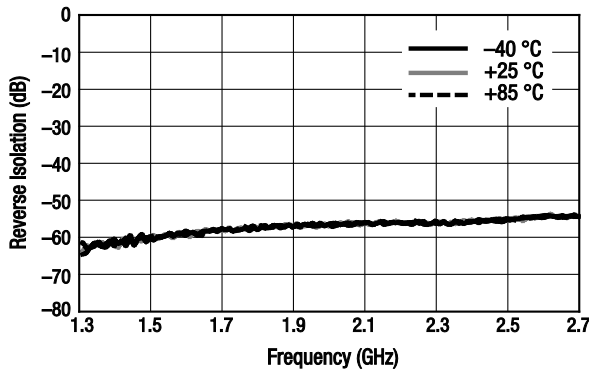

Figure 5. Reverse Isolation vs Frequency Over Temperature, Narrow Band

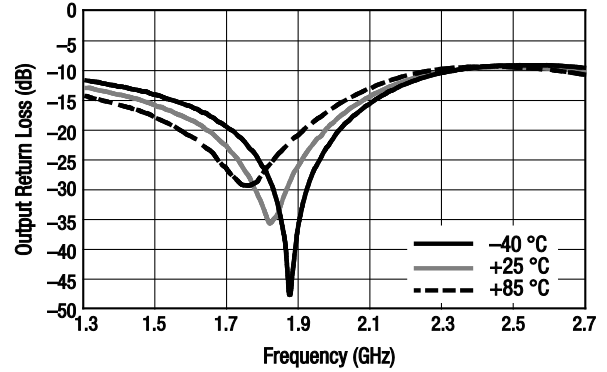

Figure 6. Output Return Loss vs Frequency Over Temperature, Narrow Band

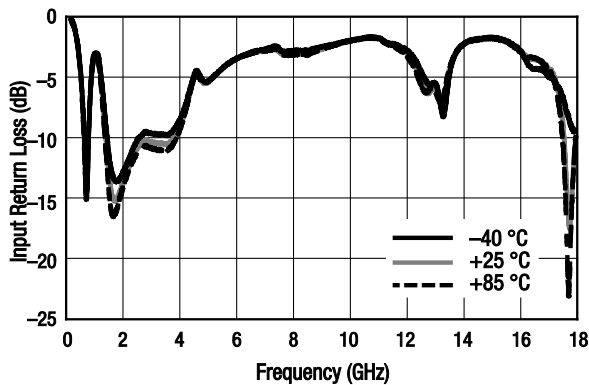

Figure 7. Input Return Loss vs Frequency Over Temperature, Wide Band

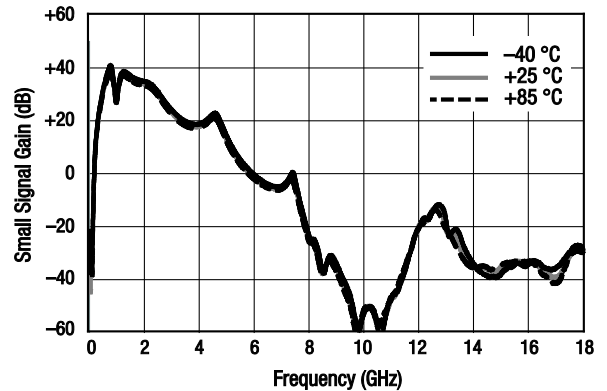

Figure 8. Small Signal Gain vs Frequency Over Temperature, Wide Band

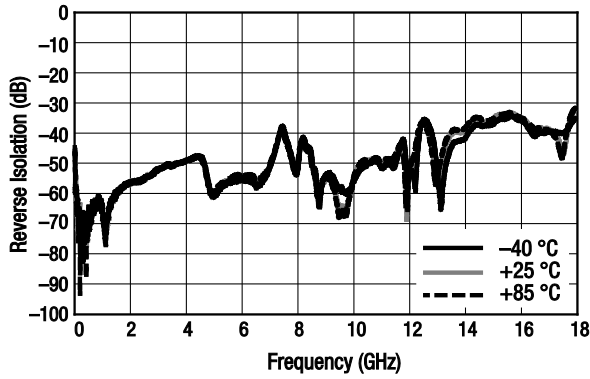

Figure 9. Reverse Isolation vs Frequency Over Temperature, Wide Band

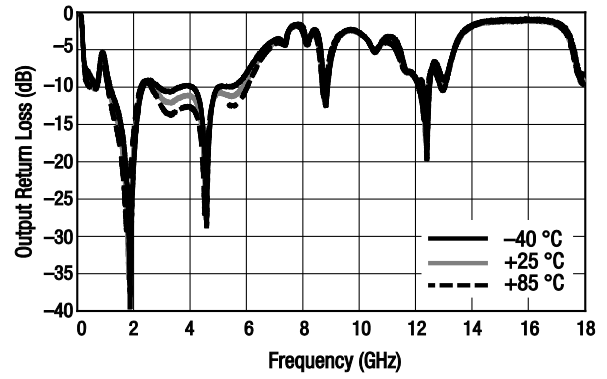

Figure 10. Output Return Loss vs Frequency Over Temperature, Wide Band

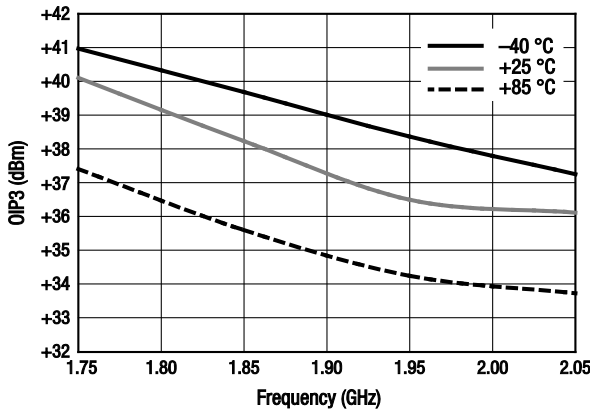

Figure 11. OIP3 vs Frequency Over Temperature

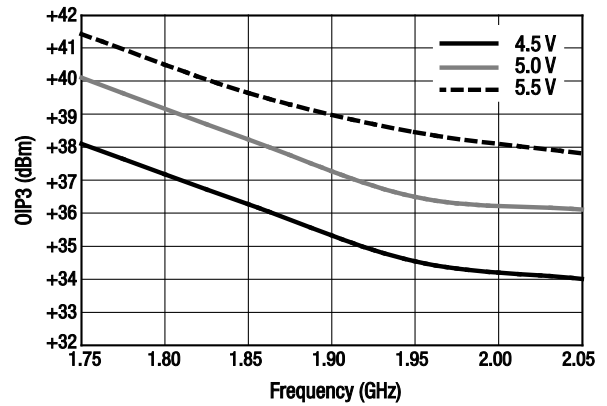

Figure 12. OIP3 vs Frequency Over Voltage

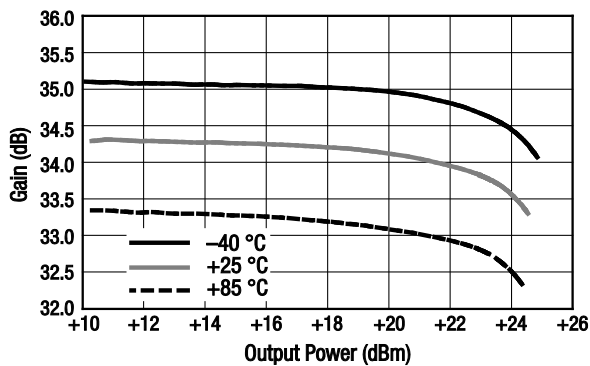

Figure 13. Gain vs Output Power Over Temperature

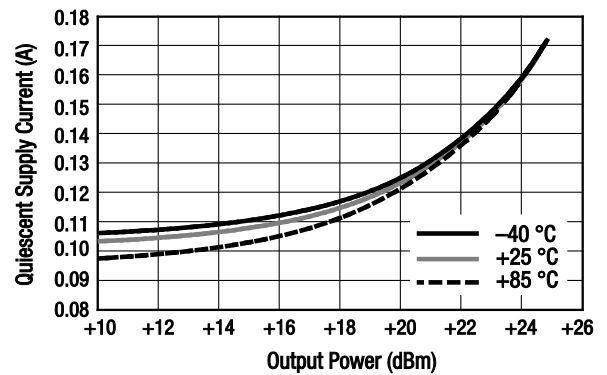

Figure 14. Quiescent Supply Current vs Output Power Over Temperature

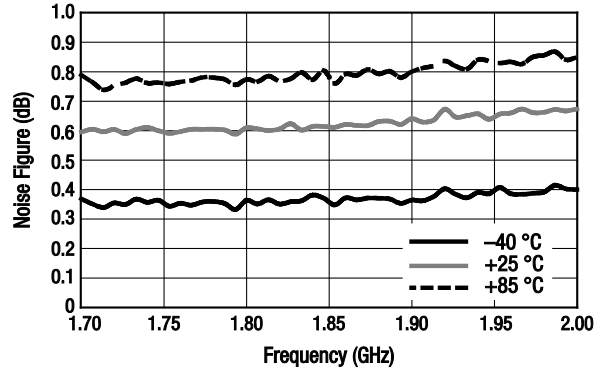

Figure 15. Noise Figure vs Frequency Over Temperature

Table 4. SKY67106-306LF Electrical Specifications (Note 1)

(V<sub>DD</sub> = +5 V, T<sub>OP</sub> = +25 °C, P<sub>IN</sub> = -30 dBm, Characteristic Impedance [Z<sub>0</sub>] = 50 Ω, Optimized for 2600 MHz Operation, Unless Otherwise Noted)

Parameter	Symbol	Test Condition	Min	Typical	Max	Units
<b>RF Specifications</b>						
Noise Figure	NF	@ 2600 MHz		0.92	1.10	dB
Small signal gain	IS21I	@ 2600 MHz	28	31		dB
Input return loss	IS11I	@ 2600 MHz	8	10		dB
Output return loss	IS22I	@ 2600 MHz	18	30		dB
Reverse isolation	IS12I	@ 2600 MHz	48	53		dB
3 <sup>rd</sup> Order Input Intercept Point	IIP3	@ 2600 MHz, Δf = 1 MHz, P <sub>IN</sub> = -30 dBm/tone	+1	+4		dBm
3 <sup>rd</sup> Order Output Intercept Point	OIP3	@ 2600 MHz, Δf = 1 MHz, P <sub>IN</sub> = -30 dBm/tone	+32	+35		dBm
1 dB Input Compression Point	IP1dB	@ 2600 MHz	-9.5	-7		dBm
1 dB Output Compression Point	OP1dB	@ 2600 MHz	+21.5	+24		dBm
<b>DC Specifications</b>						
Supply voltage	V <sub>DD</sub>		3.5	5.0	5.5	V
Quiescent current	I <sub>DD</sub>	Set with external resistor		98	125	mA
Supply current @ IP1dB	I <sub>DD_IP1dB</sub>	Set with external resistor		160	190	mA

Note 1: Performance is guaranteed only under the conditions listed in this Table.

**Typical Performance Characteristics (2600 MHz)**

( $V_{DD} = +5\text{ V}$ ,  $T_{OP} = +25\text{ }^{\circ}\text{C}$ ,  $P_{IN} = -30\text{ dBm}$ , Characteristic Impedance [ $Z_0$ ] =  $50\text{ }\Omega$ , Optimized for 2600 MHz Operation, Unless Otherwise Noted)

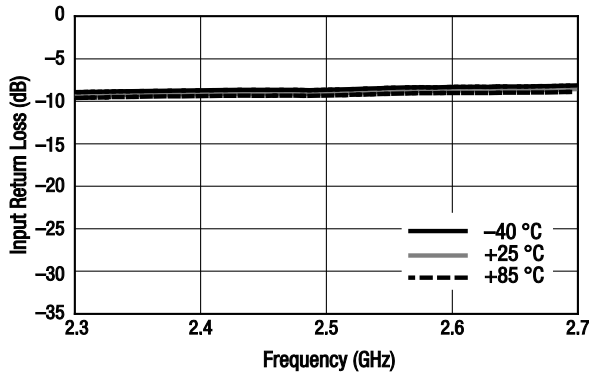

**Figure 16. Input Return Loss vs Frequency Over Temperature, Narrow Band**

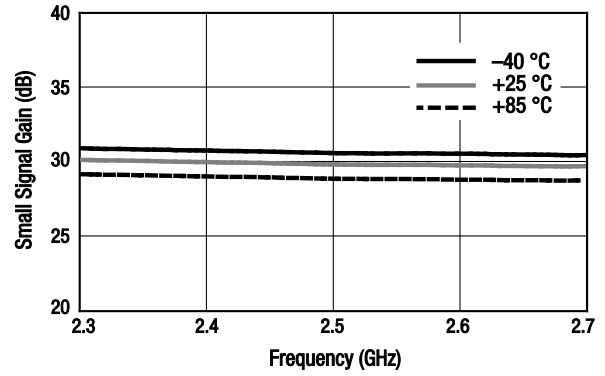

**Figure 17. Small Signal Gain vs Frequency Over Temperature, Narrow Band**

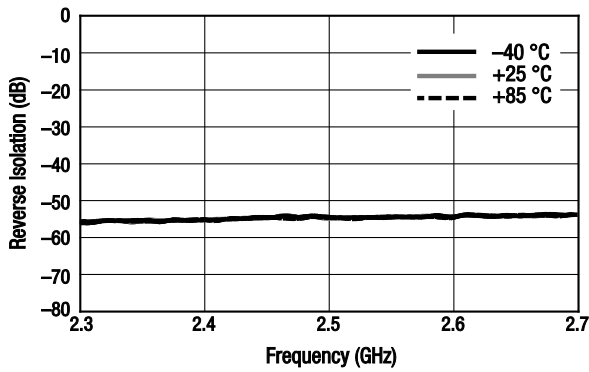

**Figure 18. Reverse Isolation vs Frequency Over Temperature, Narrow Band**

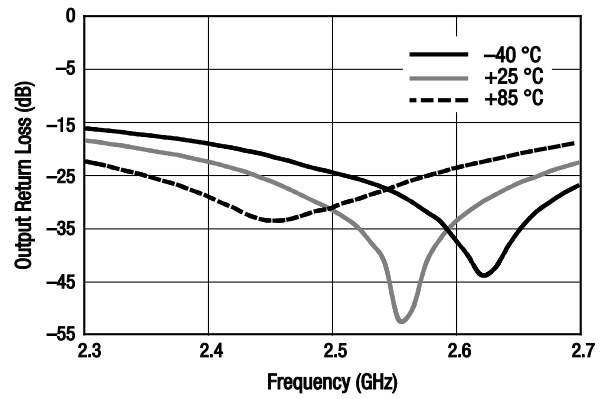

**Figure 19. Output Return Loss vs Frequency Over Temperature, Narrow Band**

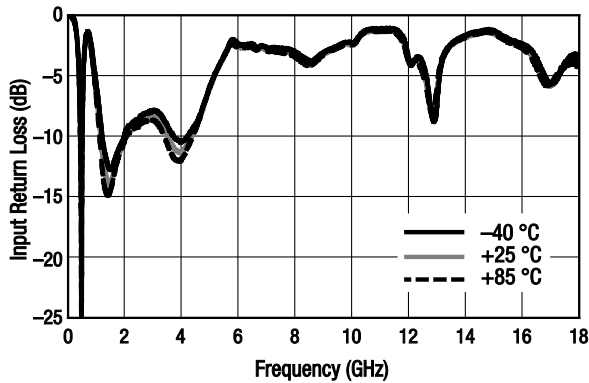

**Figure 20. Input Return Loss vs Frequency Over Temperature, Wide Band**

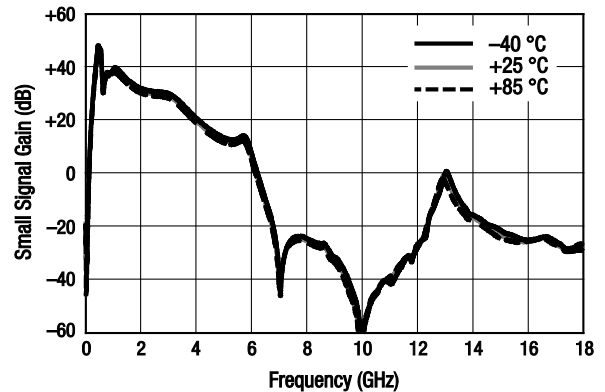

**Figure 21. Small Signal Gain vs Frequency Over Temperature, Wide Band**

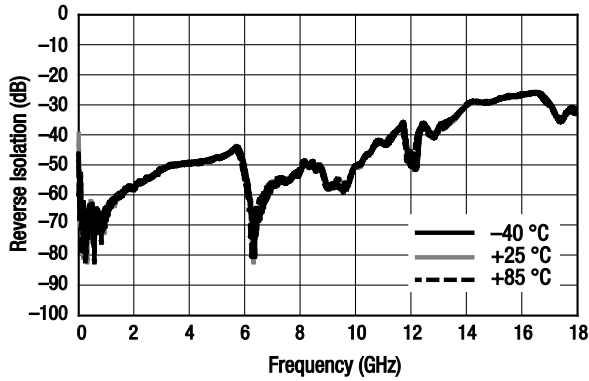

Figure 22. Reverse Isolation vs Frequency Over Temperature, Wide Band

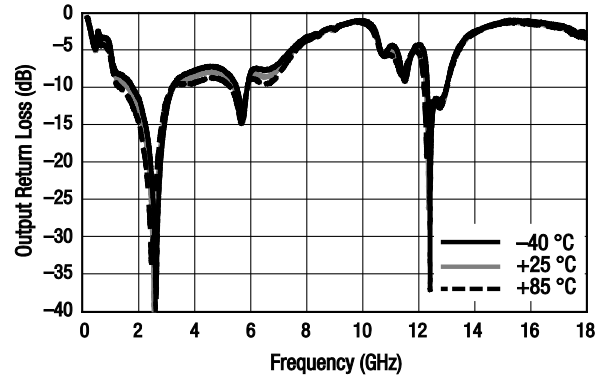

Figure 23. Output Return Loss vs Frequency Over Temperature, Wide Band

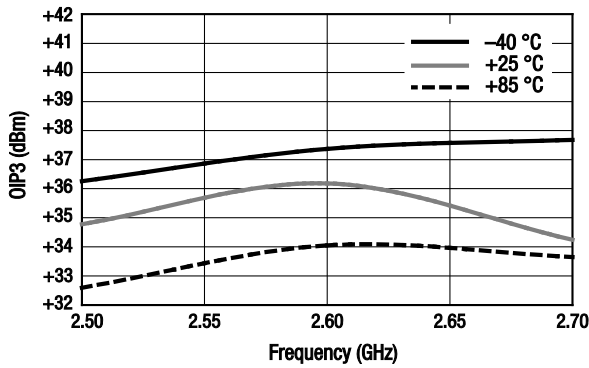

Figure 24. OIP3 vs Frequency Over Temperature

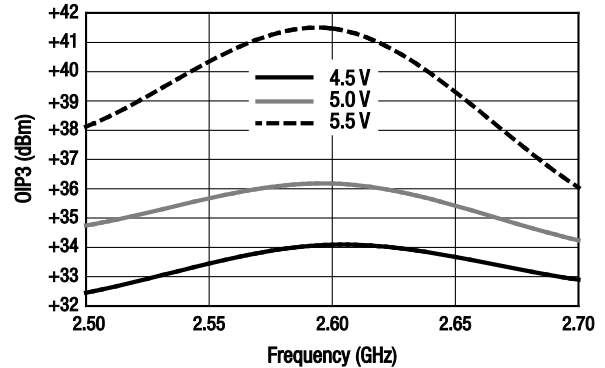

Figure 25. OIP3 vs Frequency Over Voltage

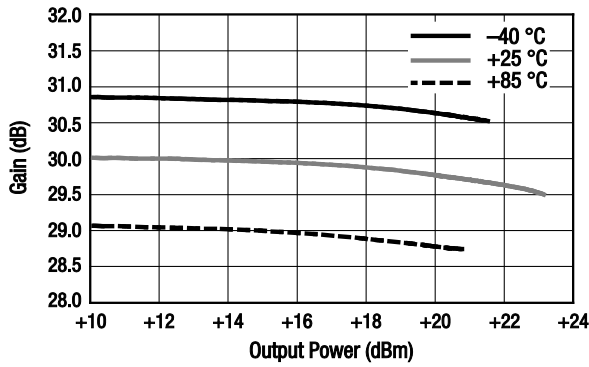

Figure 26. Gain vs Output Power Over Temperature

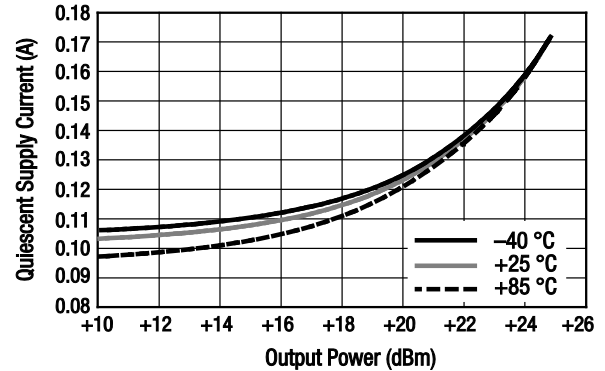
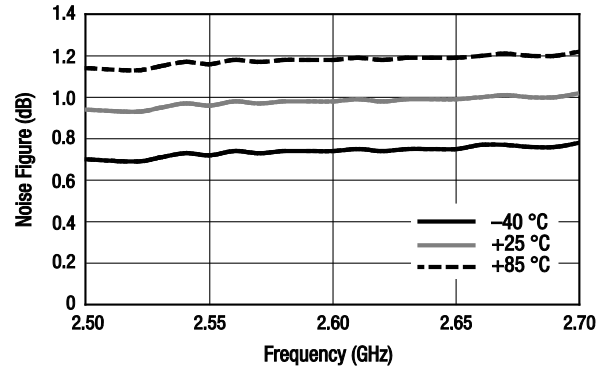

Figure 27. Quiescent Supply Current vs Output Power Over Temperature





**Figure 28. Noise Figure vs Frequency Over Temperature**

### Evaluation Board Description

The SKY67106-306LF Evaluation Board is used to test the performance of the SKY67106-306LF two-stage LNA. An Evaluation Board schematic diagram is provided in Figure 29 (1950 MHz) and Table 5 provides the Evaluation Board Bill of Materials (1950 MHz).

An Evaluation Board schematic diagram is provided in Figure 30 (2600 MHz) and Table 6 provides the Evaluation Board Bill of Materials (2600 MHz).

Evaluation Board assembly drawings are shown in Figure 31 (1950 MHz) and in Figure 32 (2600 MHz).

This Evaluation Board has many unused pads for components so that it can accommodate tuning over a wide range of frequencies. Refer to the relevant assembly diagram, schematic, and Bill of Materials for the correct component values and placements for a particular operating frequency.

Note that the VDD3 pin on the Evaluation Board does not need to be connected and should be left open.

### Package Dimensions

The PCB layout footprint for the SKY67106-306LF is shown in Figure 33. Typical case markings are noted in Figure 34. Package dimensions for the 16-pin QFN are shown in Figure 35, and tape and reel dimensions are provided in Figure 36.

### Package and Handling Information

Instructions on the shipping container label regarding exposure to moisture after the container seal is broken must be followed. Otherwise, problems related to moisture absorption may occur when the part is subjected to high temperature during solder assembly.

THE SKY67106-306LF is rated to Moisture Sensitivity Level 1 (MSL1) at 260 °C. It can be used for lead or lead-free soldering. For additional information, refer to the Skyworks Application Note, *Solder Reflow Information*, document number 200164.

Care must be taken when attaching this product, whether it is done manually or in a production solder reflow environment. Production quantities of this product are shipped in a standard tape and reel format.

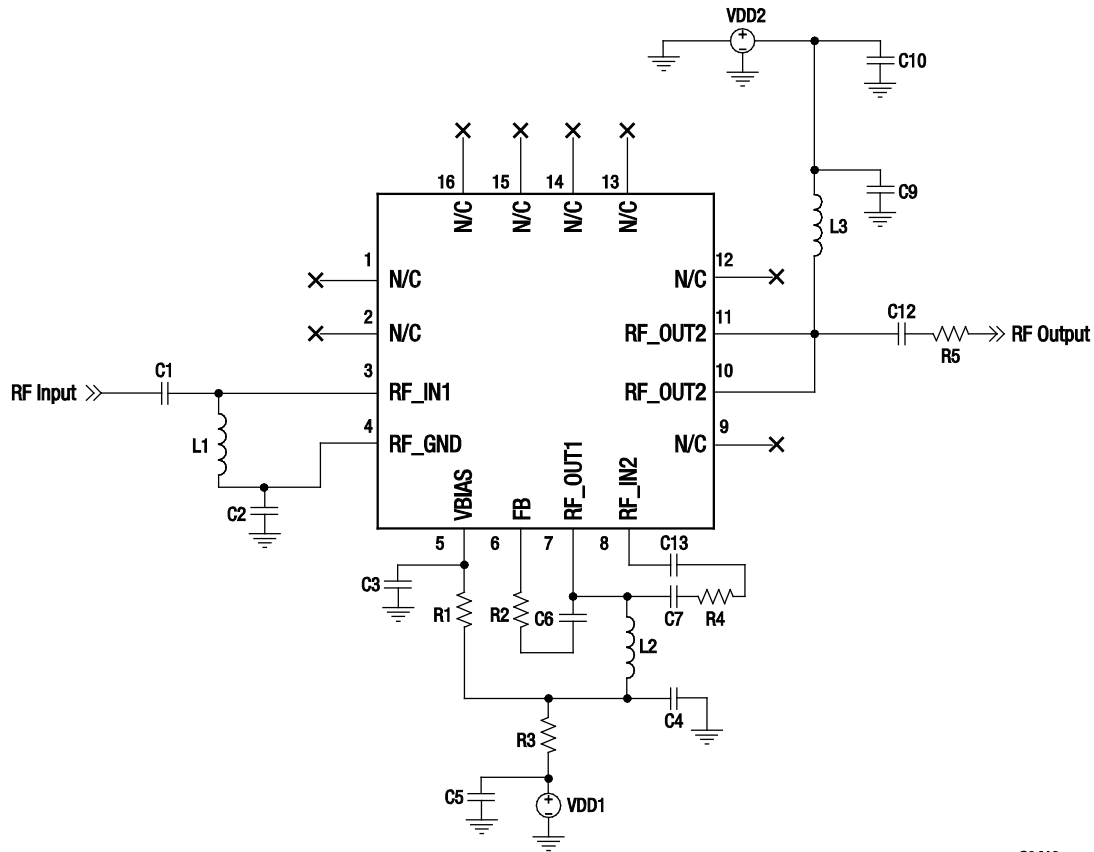

S2418

Figure 29. SKY67106-306LF Evaluation Board Schematic (1950 MHz)

Table 5. SKY67106-306LF Evaluation Board Bill of Materials (1950 MHz)

Component	Value	Size	Manufacturer	Manufacturer Part Number
C1	18 pF	0402	Murata GJM	
C2	9 pF	0402	Murata GJM	
C3	0.1 $\mu$ F	0402	Murata GRM	
C6, C9	2.7 pF	0402	Murata GRM	
C7	3.9 pF	0402	Murata GRM	
C4	10000 pF	0402	Murata GRM	
C5	1000 pF	0402	Murata GRM	
C10	100 pF	0402	Murata GRM	
C12	12 pF	0402	Murata GRM	
C13	22 pF	0402	Murata GRM	
L1	4.3 nH	0402	Coilcraft HP	
L2	3.3 nH	0402	TDK MLG	
L3	27 nH	0402	TDK MLG	
R1	2 k $\Omega$	0402	Panasonic 1%	
R2	200 $\Omega$	0402	Panasonic 1%	
R3, R4, R5	0 $\Omega$	0402	Panasonic	

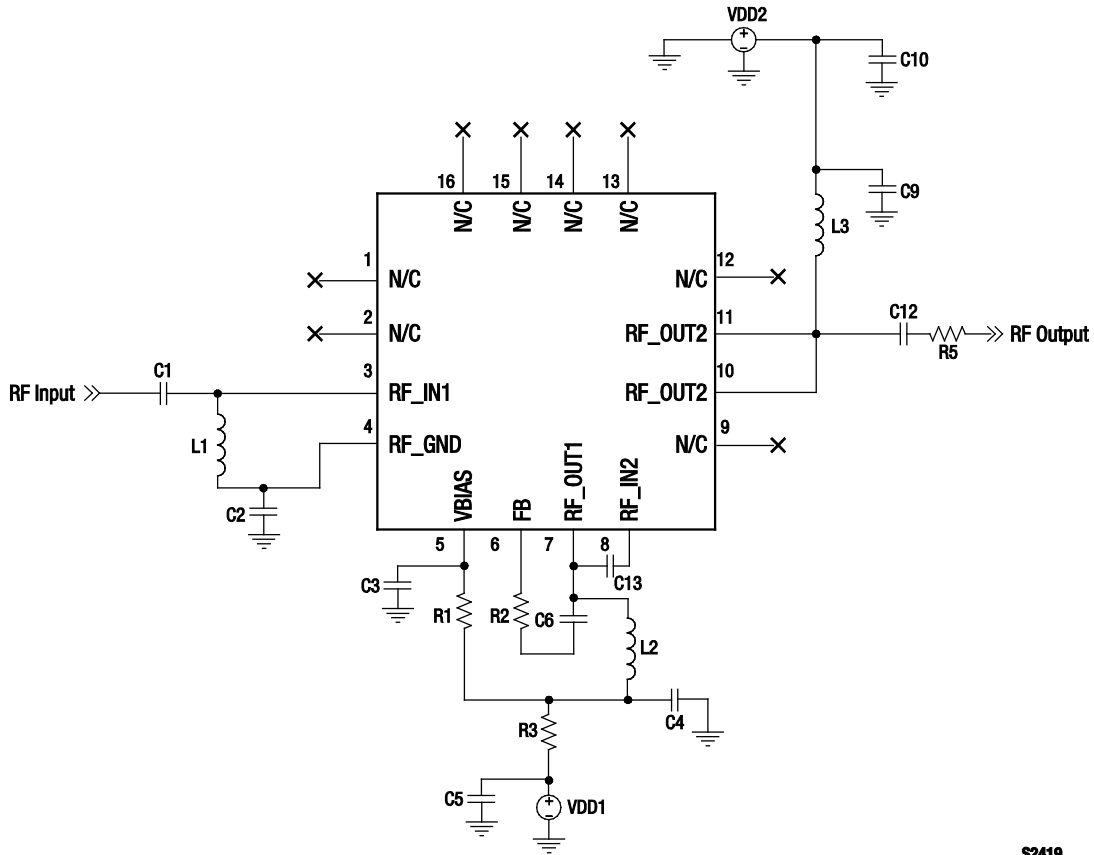

S2419

Figure 30. SKY67106-306LF Evaluation Board Schematic (2600 MHz)

Table 6. SKY67106-306LF Evaluation Board Bill of Materials (2600 MHz)

Component	Value	Size	Manufacturer	Manufacturer Part Number
C1	10 pF	0402	Murata GJM	
C2	20 pF	0402	Murata GJM	
C3	0.1 $\mu$ F	0402	Murata GRM	
C6, C9	2.7 pF	0402	Murata GRM	
C4	10000 pF	0402	Murata GRM	
C5, C10	1000 pF	0402	Murata GRM	
C12	39 pF	0402	Murata GRM	
C13	15 pF	0402	Murata GRM	
L1	5.1 nH	0402	Coilcraft CS	
L2	3.3 nH	0402	TDK MLG	
L3	10 nH	0402	TDK MLG	
R1	2 k $\Omega$	0402	Panasonic 1%	
R2	200 $\Omega$	0402	Panasonic 1%	
R3, R5	0 $\Omega$	0402	Panasonic	

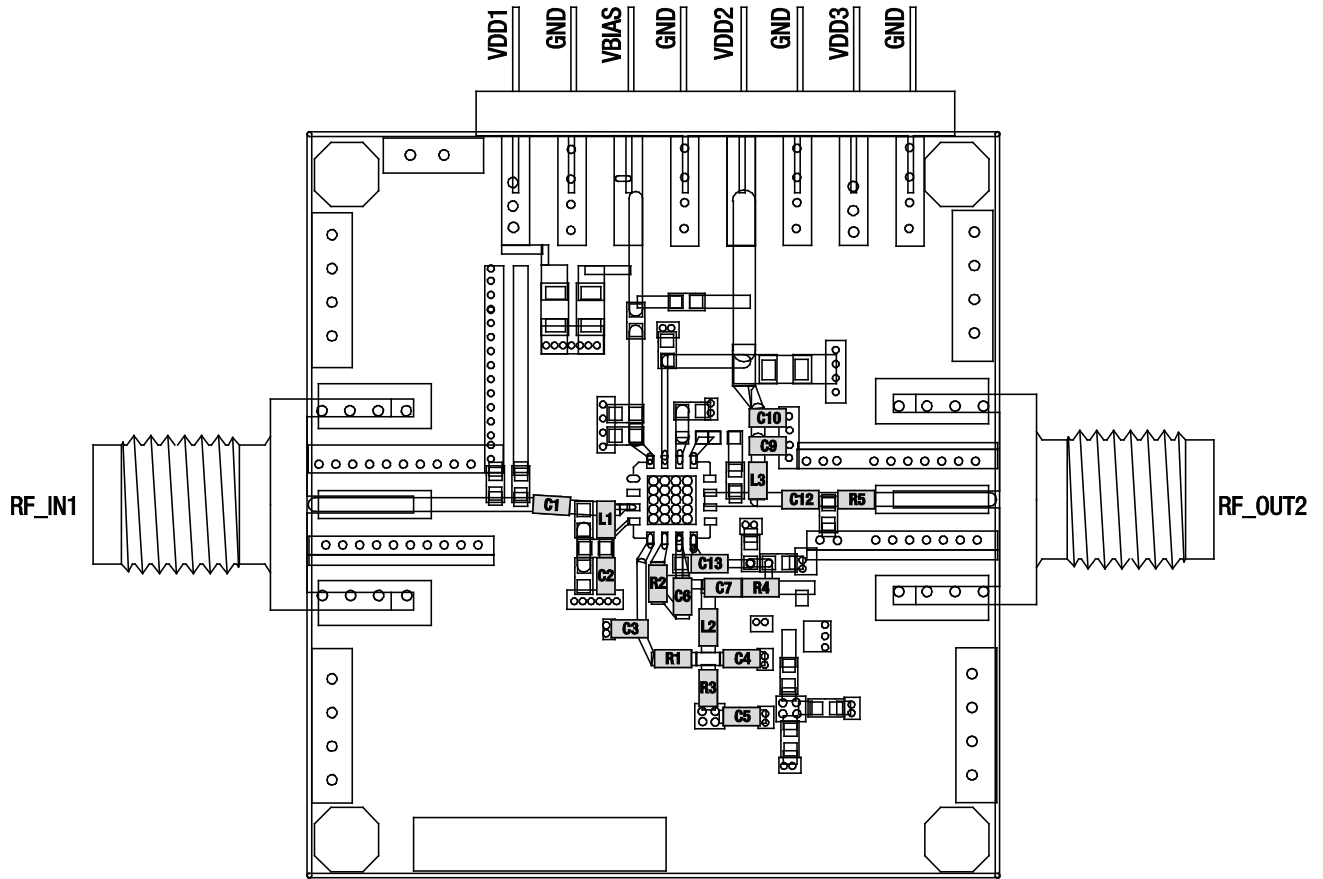

*Note: The VDD3 pin should be left unconnected.*

**S2503**

**Figure 31. SKY67106-306LF Evaluation Board Assembly Diagram (1950 MHz)**

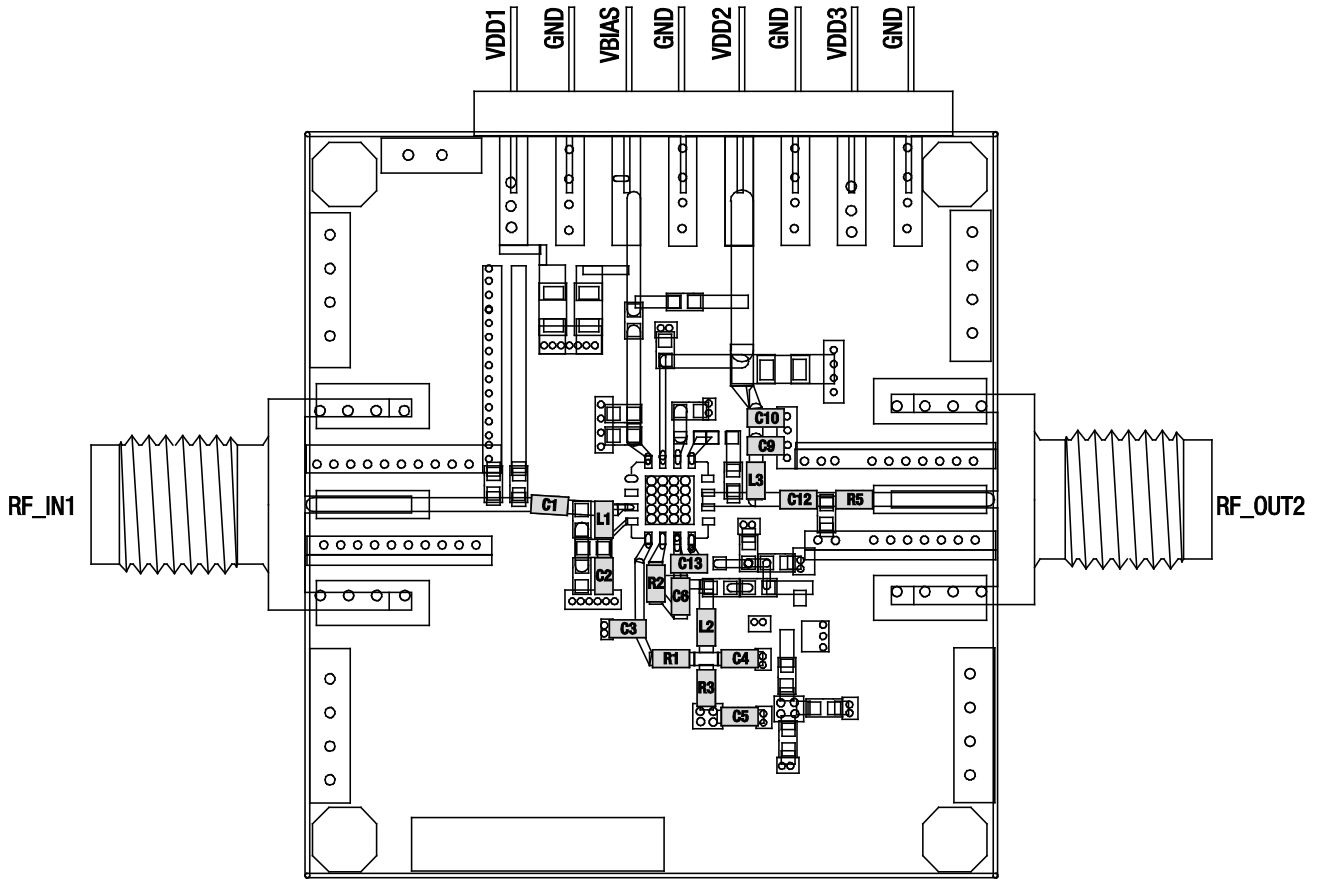

*Note: The VDD3 pin should be left unconnected.*

**S2504**

**Figure 32. SKY67106-306LF Evaluation Board Assembly Diagram (2600 MHz)**

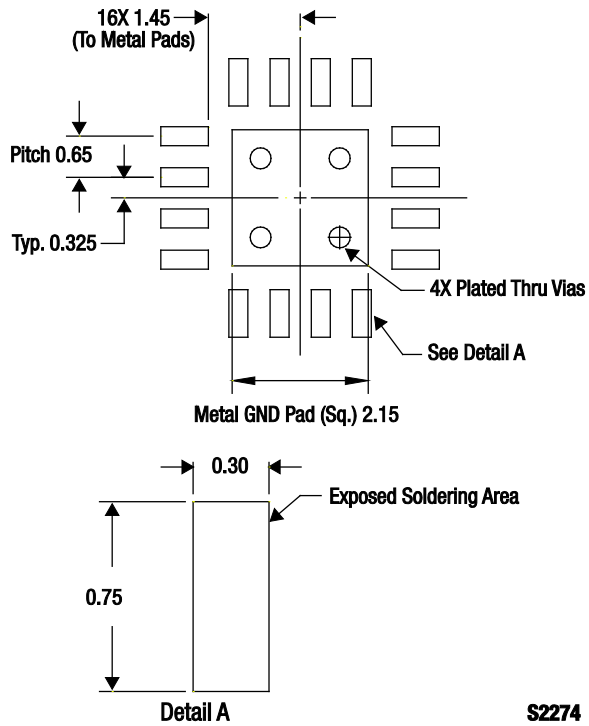

Figure 33. SKY67106-306LF PCB Layout Footprint

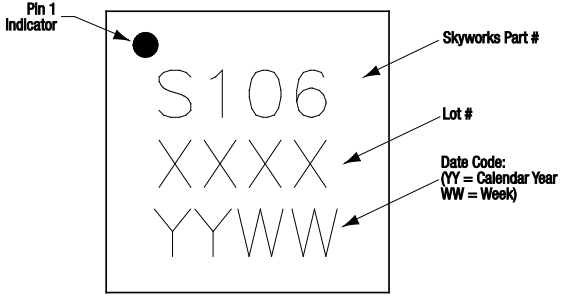
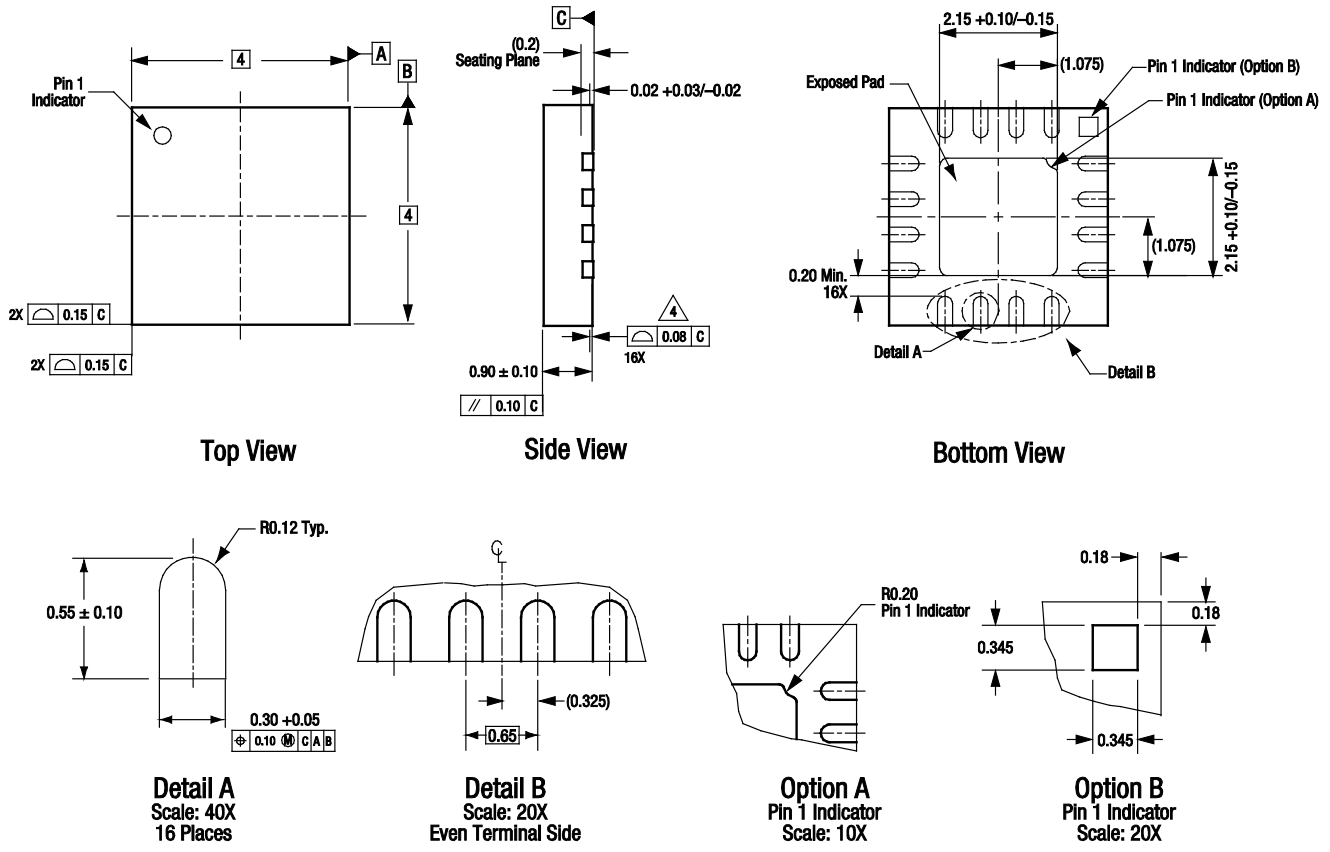

Figure 34. Typical Case Markings



All measurements are in millimeters.  
 Dimensioning and tolerancing according to ASME Y14.5M-1994.  
 Coplanarity applies to the exposed heat sink slug as well as the terminals.  
 Package may have option A or option B pin 1 indicator.

S2400

Figure 35. SKY67106-306LF 16-Pin QFN Package Dimensions

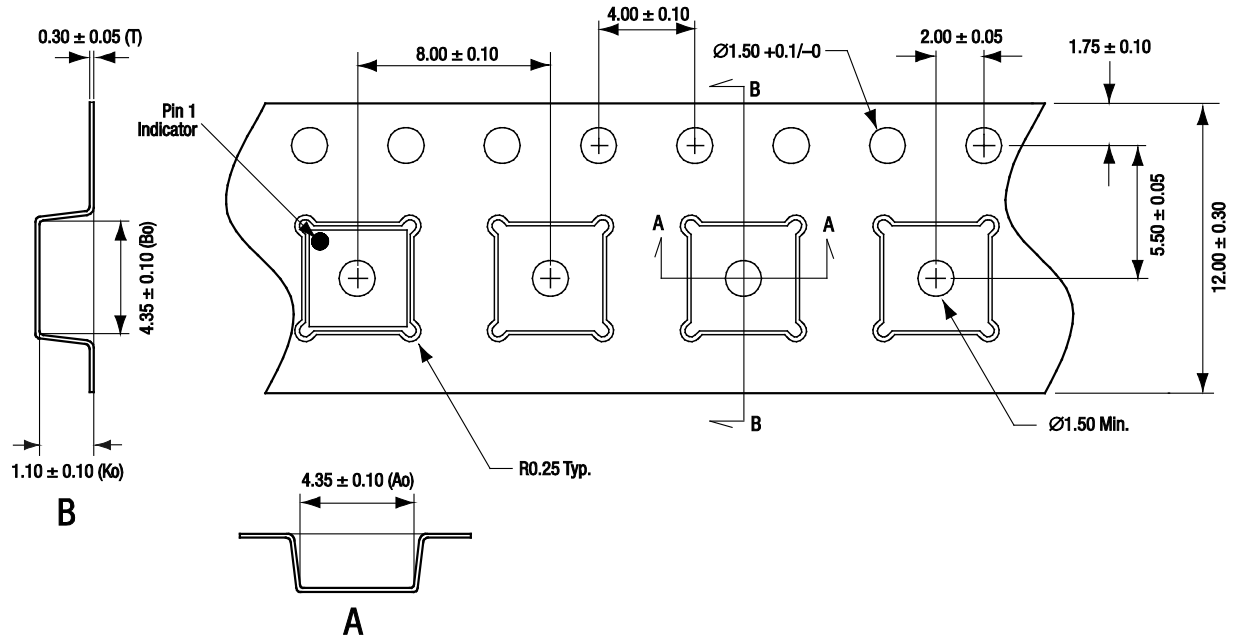

- Notes:
1. Carrier tape material: black conductive polystyrene, non-bakeable
  2. Cover tape material: transparent conductive HSA
  3. Cover tape size: 9.2 mm width
  4. ESD surface resistivity is  $\geq 1 \times 10^9 \sim \leq 1 \times 10^{10}$  Ohms/square per EIA, JEDEC TNR Specification.
  5. All measurements are in millimeters

S1846

Figure 36. SKY67106-306LF Tape and Reel Dimensions



**Ordering Information**

Model Name	Manufacturing Part Number	Evaluation Board Part Number
SKY67106-306LF Two-Stage LNA	SKY67106-306LF	SKY67106-306LF-EVB

Copyright © 2011 Skyworks Solutions, Inc. All Rights Reserved.

Information in this document is provided in connection with Skyworks Solutions, Inc. (“Skyworks”) products or services. These materials, including the information contained herein, are provided by Skyworks as a service to its customers and may be used for informational purposes only by the customer. Skyworks assumes no responsibility for errors or omissions in these materials or the information contained herein. Skyworks may change its documentation, products, services, specifications or product descriptions at any time, without notice. Skyworks makes no commitment to update the materials or information and shall have no responsibility whatsoever for conflicts, incompatibilities, or other difficulties arising from any future changes.

No license, whether express, implied, by estoppel or otherwise, is granted to any intellectual property rights by this document. Skyworks assumes no liability for any materials, products or information provided hereunder, including the sale, distribution, reproduction or use of Skyworks products, information or materials, except as may be provided in Skyworks Terms and Conditions of Sale.

THE MATERIALS, PRODUCTS AND INFORMATION ARE PROVIDED “AS IS” WITHOUT WARRANTY OF ANY KIND, WHETHER EXPRESS, IMPLIED, STATUTORY, OR OTHERWISE, INCLUDING FITNESS FOR A PARTICULAR PURPOSE OR USE, MERCHANTABILITY, PERFORMANCE, QUALITY OR NON-INFRINGEMENT OF ANY INTELLECTUAL PROPERTY RIGHT; ALL SUCH WARRANTIES ARE HEREBY EXPRESSLY DISCLAIMED. SKYWORKS DOES NOT WARRANT THE ACCURACY OR COMPLETENESS OF THE INFORMATION, TEXT, GRAPHICS OR OTHER ITEMS CONTAINED WITHIN THESE MATERIALS. SKYWORKS SHALL NOT BE LIABLE FOR ANY DAMAGES, INCLUDING BUT NOT LIMITED TO ANY SPECIAL, INDIRECT, INCIDENTAL, STATUTORY, OR CONSEQUENTIAL DAMAGES, INCLUDING WITHOUT LIMITATION, LOST REVENUES OR LOST PROFITS THAT MAY RESULT FROM THE USE OF THE MATERIALS OR INFORMATION, WHETHER OR NOT THE RECIPIENT OF MATERIALS HAS BEEN ADVISED OF THE POSSIBILITY OF SUCH DAMAGE.

Skyworks products are not intended for use in medical, lifesaving or life-sustaining applications, or other equipment in which the failure of the Skyworks products could lead to personal injury, death, physical or environmental damage. Skyworks customers using or selling Skyworks products for use in such applications do so at their own risk and agree to fully indemnify Skyworks for any damages resulting from such improper use or sale.

Customers are responsible for their products and applications using Skyworks products, which may deviate from published specifications as a result of design defects, errors, or operation of products outside of published parameters or design specifications. Customers should include design and operating safeguards to minimize these and other risks. Skyworks assumes no liability for applications assistance, customer product design, or damage to any equipment resulting from the use of Skyworks products outside of stated published specifications or parameters.

Skyworks, the Skyworks symbol, and “Breakthrough Simplicity” are trademarks or registered trademarks of Skyworks Solutions, Inc., in the United States and other countries. Third-party brands and names are for identification purposes only, and are the property of their respective owners. Additional information, including relevant terms and conditions, posted at [www.skyworksinc.com](http://www.skyworksinc.com), are incorporated by reference.



## Стандарт Электрон Связь

Мы молодая и активно развивающаяся компания в области поставок электронных компонентов. Мы поставляем электронные компоненты отечественного и импортного производства напрямую от производителей и с крупнейших складов мира.

Благодаря сотрудничеству с мировыми поставщиками мы осуществляем комплексные и плановые поставки широчайшего спектра электронных компонентов.

Собственная эффективная логистика и склад в обеспечивает надежную поставку продукции в точно указанные сроки по всей России.

Мы осуществляем техническую поддержку нашим клиентам и предпродажную проверку качества продукции. На все поставляемые продукты мы предоставляем гарантию .

Осуществляем поставки продукции под контролем ВП МО РФ на предприятия военно-промышленного комплекса России , а также работаем в рамках 275 ФЗ с открытием отдельных счетов в уполномоченном банке. Система менеджмента качества компании соответствует требованиям ГОСТ ISO 9001.

Минимальные сроки поставки, гибкие цены, неограниченный ассортимент и индивидуальный подход к клиентам являются основой для выстраивания долгосрочного и эффективного сотрудничества с предприятиями радиоэлектронной промышленности, предприятиями ВПК и научно-исследовательскими институтами России.

С нами вы становитесь еще успешнее!

### Наши контакты:

**Телефон:** +7 812 627 14 35

**Электронная почта:** [sales@st-electron.ru](mailto:sales@st-electron.ru)

**Адрес:** 198099, Санкт-Петербург,  
Промышленная ул, дом № 19, литера Н,  
помещение 100-Н Офис 331