

# FGD3N60LSD IGBT

## Features

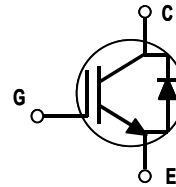
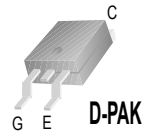
- High Current Capability
- Very Low Saturation Voltage :  $V_{CE(sat)} = 1.2 \text{ V @ } I_C = 3 \text{ A}$
- High Input Impedance

## Applications

- HID Lamp Applications
- Piezo Fuel Injection Applications

## Description

Fairchild's Insulated Gate Bipolar Transistors (IGBTs) provide very low conduction losses. The device is designed for applications where very low On-Voltage Drop is a required feature.



## Absolute Maximum Ratings

Symbol	Description	FGD3N60LSD	Units
$V_{CES}$	Collector-Emitter Voltage	600	V
$V_{GES}$	Gate-Emitter Voltage	$\pm 25$	V
$I_C$	Collector Current @ $T_C = 25^\circ\text{C}$	6	A
	Collector Current @ $T_C = 100^\circ\text{C}$	3	A
$I_{CM(1)}$	Pulsed Collector Current (1)	25	A
$I_F$	Diode Continuous Forward Current @ $T_C = 100^\circ\text{C}$	3	A
$I_{FM}$	Diode Maximum Forward Current	25	A
$P_D$	Maximum Power Dissipation @ $T_C = 25^\circ\text{C}$	40	W
	Derating Factor	0.32	W/°C
$T_J$	Operating Junction Temperature	-55 to +150	°C
$T_{stg}$	Storage Temperature Range	-55 to +150	°C
$T_L$	Maximum Lead Temp. for Soldering Purposes, 1/8" from Case for 5 Seconds	250	°C

**Notes :**

(1) Repetitive rating : Pulse width limited by max. junction temperature

## Thermal Characteristics

Symbol	Parameter	Typ.	Max.	Units
$R_{\theta JC}$ (IGBT)	Thermal Resistance, Junction-to-Case	--	3.1	°C/W
$R_{\theta JA}$	Thermal Resistance, Junction-to-Ambient (PCB Mount) (2)	--	100	°C/W

**Notes :**

(2) Mounted on 1" square PCB (FR4 or G-10 Material)

## Package Marking and Ordering Information

Device Marking	Device	Package	Reel Size	Tape Width	Quantity
FGD3N60LSD	FGD3N60LSDTM	D-PAK	380mm	16mm	2500

## Electrical Characteristics of the IGBT T<sub>C</sub> = 25°C unless otherwise noted

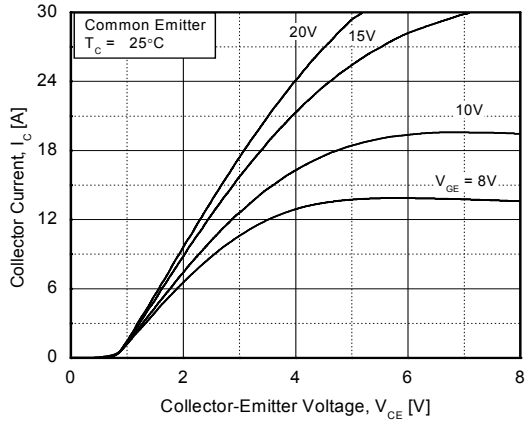
Symbol	Parameter	Test Conditions	Min.	Typ.	Max.	Units
<b>Off Characteristics</b>						
$BV_{CES}$	Collector-Emitter Breakdown Voltage	$V_{GE} = 0V, I_C = 250\mu A$	600	--	--	V
$\frac{\Delta BV_{CES}}{\Delta T_J}$	Temperature Coefficient of Breakdown Voltage	$V_{GE} = 0V, I_C = 1mA$	--	0.6	--	V/°C
$I_{CES}$	Collector Cut-Off Current	$V_{CE} = V_{CES}, V_{GE} = 0V$	--	--	250	$\mu A$
$I_{GES}$	G-E Leakage Current	$V_{GE} = V_{GES}, V_{CE} = 0V$	--	--	$\pm 100$	nA
<b>On Characteristics</b>						
$V_{GE(th)}$	G-E Threshold Voltage	$I_C = 3mA, V_{CE} = V_{GE}$	2.5	3.2	5.0	V
$V_{CE(sat)}$	Collector to Emitter Saturation Voltage	$I_C = 3A, V_{GE} = 10V$	--	1.2	1.5	V
		$I_C = 6A, V_{GE} = 10V$	--	1.8	--	V
<b>Dynamic Characteristics</b>						
$C_{ies}$	Input Capacitance	$V_{CE} = 25V, V_{GE} = 0V,$ $f = 1MHz$	--	185	--	pF
$C_{oes}$	Output Capacitance		--	20	--	pF
$C_{res}$	Reverse Transfer Capacitance		--	5.5	--	pF
<b>Switching Characteristics</b>						
$t_{d(on)}$	Turn-On Delay Time	$V_{CC} = 480V, I_C = 3A,$ $R_G = 470\Omega, V_{GE} = 10V,$ Inductive Load, $T_C = 25^\circ C$	--	40	--	ns
$t_r$	Rise Time		--	40	--	ns
$t_{d(off)}$	Turn-Off Delay Time		--	600	--	ns
$t_f$	Fall Time		--	600	--	ns
$E_{on}$	Turn-On Switching Loss		--	250	--	$\mu J$
$E_{off}$	Turn-Off Switching Loss		--	1.00	--	mJ
$E_{ts}$	Total Switching Loss		--	1.25	--	mJ
$t_{d(on)}$	Turn-On Delay Time	$V_{CC} = 480V, I_C = 3A,$ $R_G = 470\Omega, V_{GE} = 10V,$ Inductive Load, $T_C = 125^\circ C$	--	40	--	ns
$t_r$	Rise Time		--	45	--	ns
$t_{d(off)}$	Turn-Off Delay Time		--	620	--	ns
$t_f$	Fall Time		--	800	--	ns
$E_{on}$	Turn-On Switching Loss		--	300	--	$\mu J$
$E_{off}$	Turn-Off Switching Loss		--	1.9	--	mJ
$E_{ts}$	Total Switching Loss		--	2.2	--	mJ
$Q_g$	Total Gate Charge	$V_{CE} = 480V, I_C = 3A,$ $V_{GE} = 10V$	--	12.5	--	nC
$Q_{ge}$	Gate-Emitter Charge		--	2.8	--	nC
$Q_{gc}$	Gate-Collector Charge		--	4.9	--	nC
$L_e$	Internal Emitter Inductance	Measured 5mm from PKG	--	7.5	--	nH

**Electrical Characteristics of DIODE**  $T_C = 25^\circ\text{C}$  unless otherwise noted

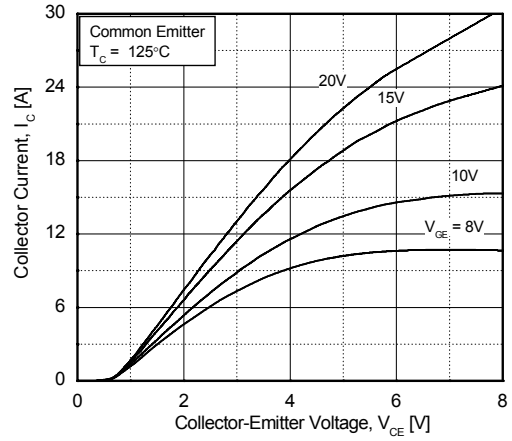
Symbol	Parameter	Test Conditions	Min.	Typ.	Max.	Units	
$V_{FM}$	Diode Forward Voltage	$I_F = 3A$	$T_C = 25^\circ\text{C}$	--	1.5	1.9	V
			$T_C = 100^\circ\text{C}$	--	1.55	--	
$t_{rr}$	Diode Reverse Recovery Time	$I_F = 3A,$ $di/dt = 100A/us$ $V_R = 200V$	$T_C = 25^\circ\text{C}$	--	234	--	ns
			$T_C = 100^\circ\text{C}$	--	--	--	
$I_{rr}$	Diode Peak Reverse Recovery Current	$I_F = 3A,$ $di/dt = 100A/us$ $V_R = 200V$	$T_C = 25^\circ\text{C}$	--	2.64	--	A
			$T_C = 100^\circ\text{C}$	--	--	--	
$Q_{rr}$	Diode Reverse Recovery Charge	$I_F = 3A,$ $di/dt = 100A/us$ $V_R = 200V$	$T_C = 25^\circ\text{C}$	--	309	--	nC
			$T_C = 100^\circ\text{C}$	--	--	--	

## Typical Performance Characteristics

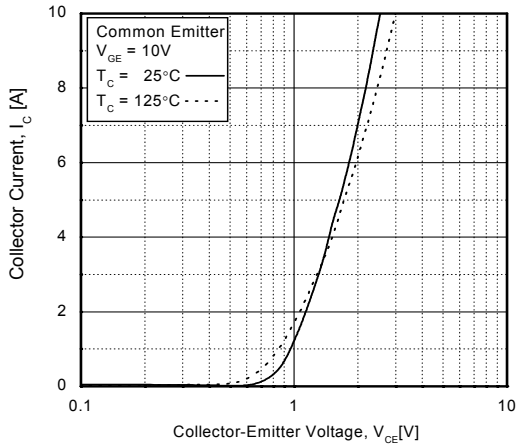
**Figure 1. Typical Output Characteristics**



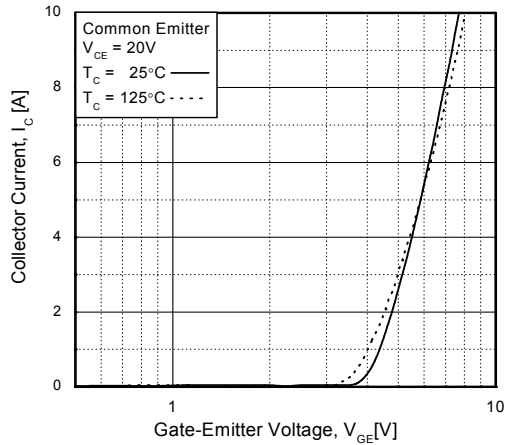
**Figure 2. Typical Output Characteristics**



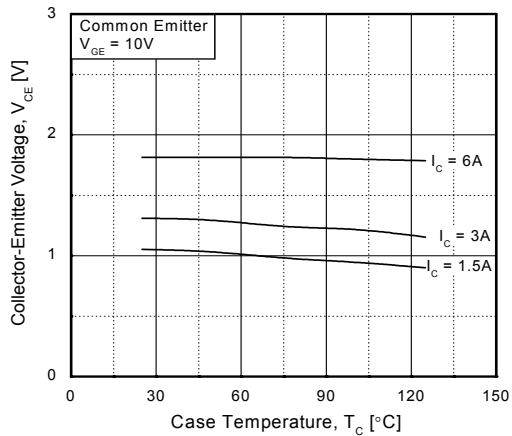
**Figure 3. Typical Output Characteristics**



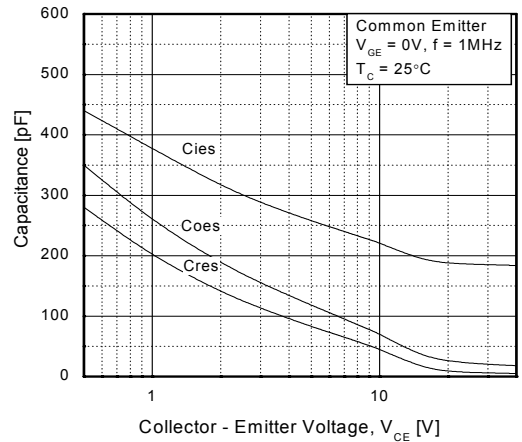
**Figure 4. Transfer Characteristics**



**Figure 5. Saturation Voltage vs. Case**

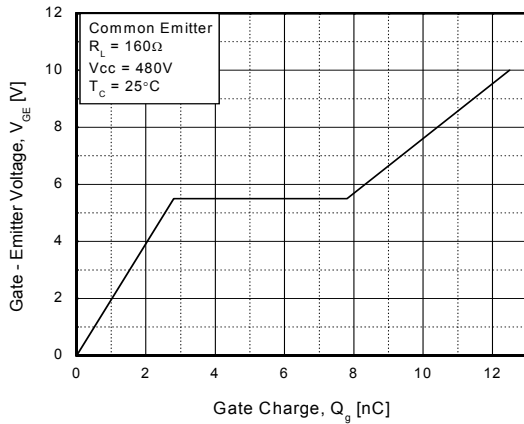


**Figure 6. Capacitance Characteristics**

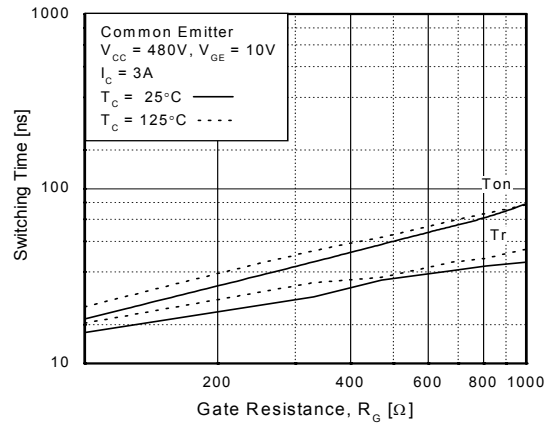


## Typical Performance Characteristics (Continued)

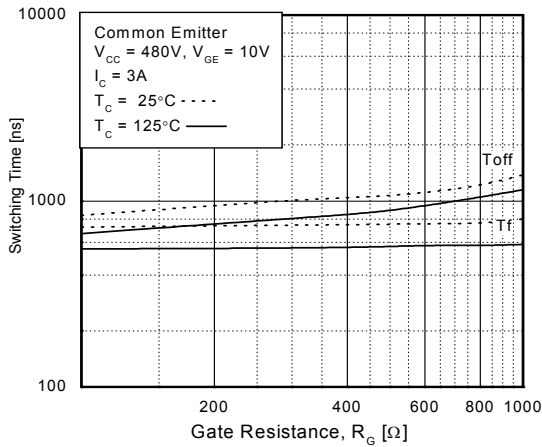
**Figure 7. Gate Charge**



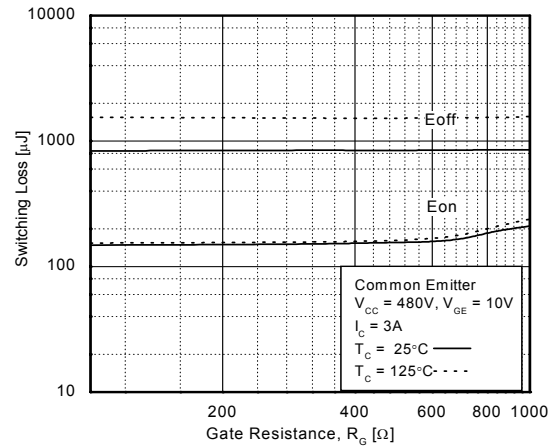
**Figure 8. Turn-On Characteristics vs. Gate Resistance**



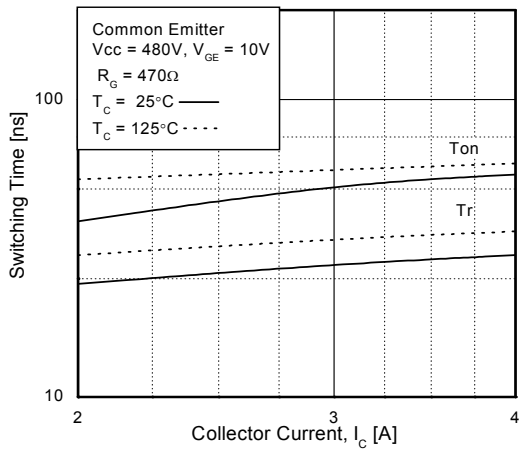
**Figure 9. Turn-Off Characteristics vs. Gate Resistance**



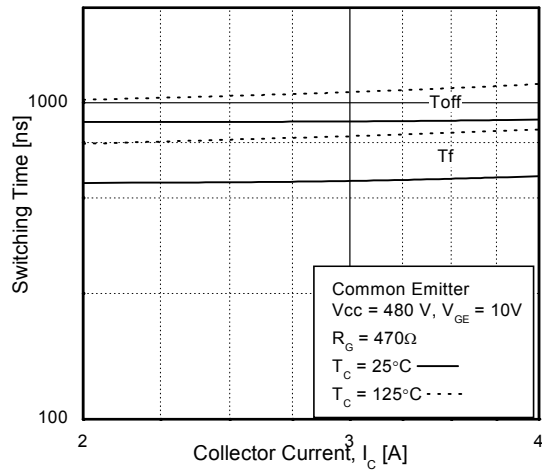
**Figure 10. Switching Loss vs. Gate Resistance**



**Figure 11. Turn-On Characteristics vs. Collector Current**

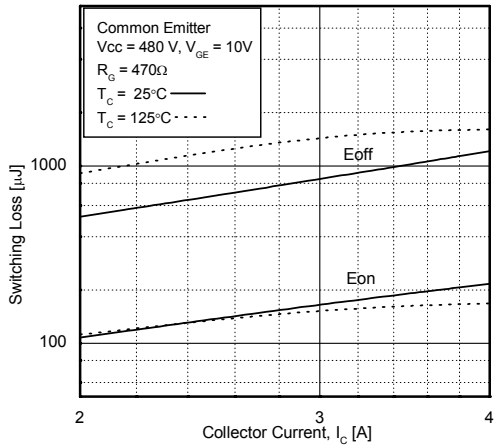


**Figure 12. Turn-Off Characteristics vs. Collector Current**

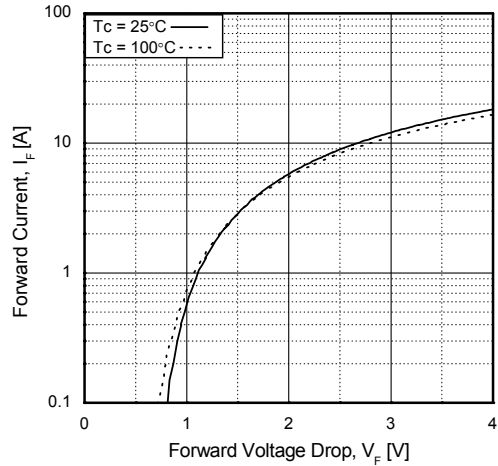


**Typical Performance Characteristics (Continued)**

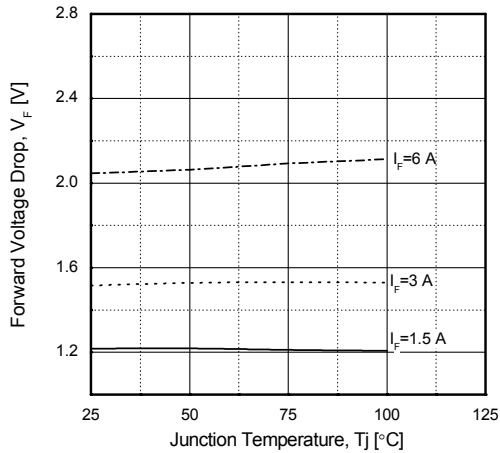
**Figure 13. Switching Loss vs. Collector Current**



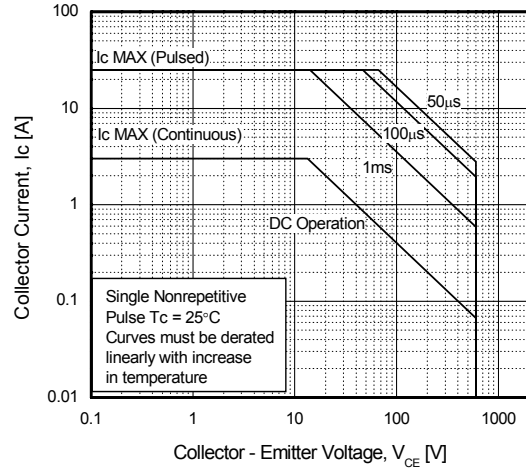
**Figure 14. Forward Characteristics**



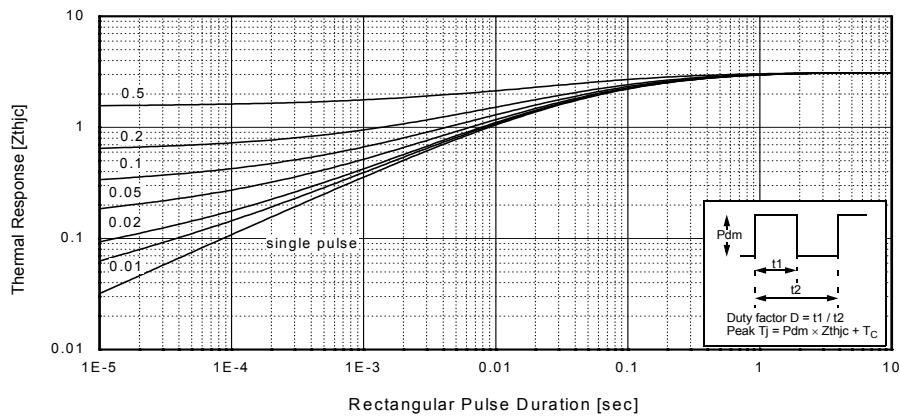
**Figure 15. Forward Voltage Drop Vs Tj**



**Figure 16. SOA Characteristics**

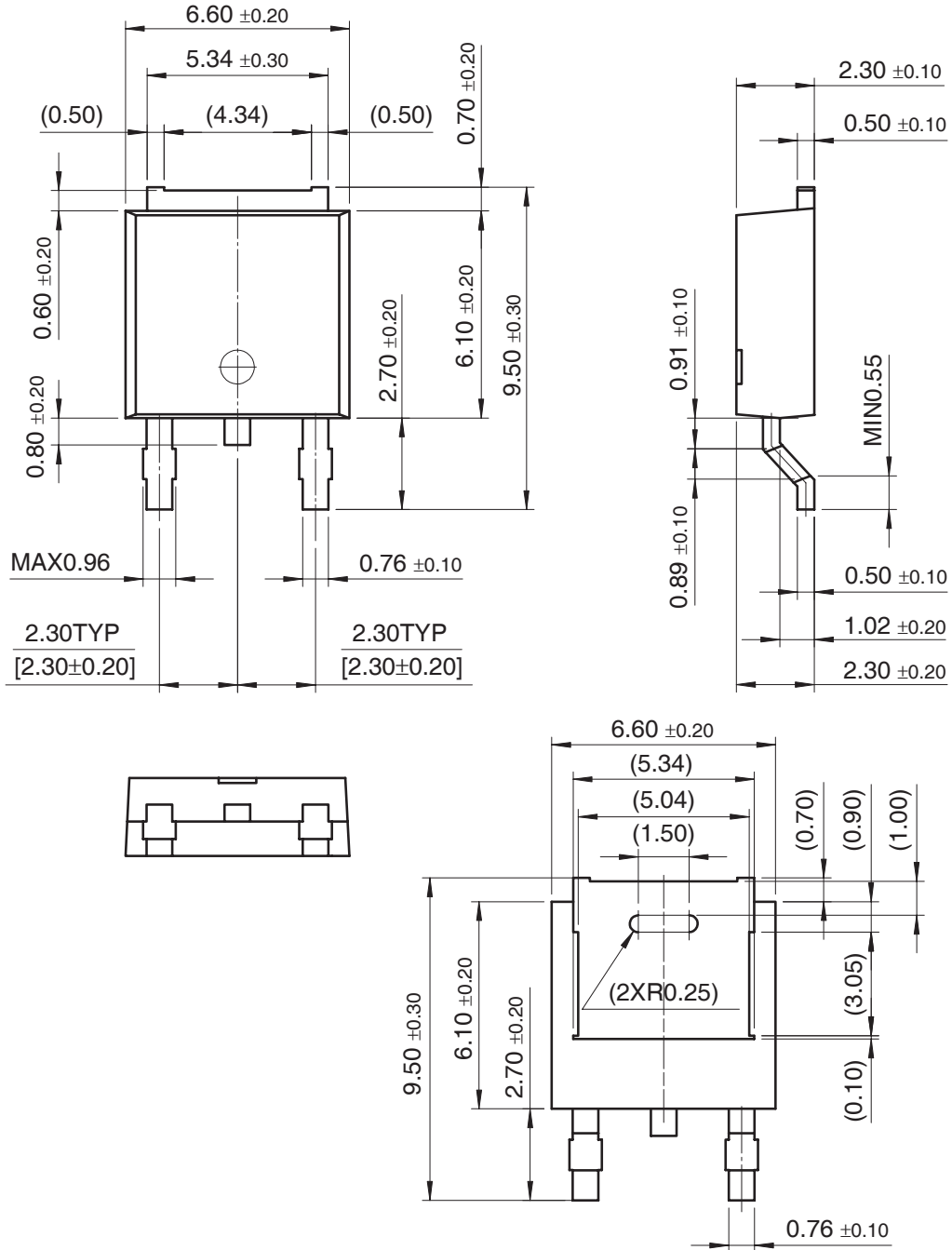


**Figure 17. Transient Thermal Impedance of IGBT**



Mechanical Dimensions

D-PAK



Dimensions in Millimeters

**TRADEMARKS**

The following are registered and unregistered trademarks Fairchild Semiconductor owns or is authorized to use and is not intended to be an exhaustive list of all such trademarks.

ACEx™	FACT Quiet Series™	OCX™	SILENT SWITCHER®	UniFET™
ActiveArray™	GlobalOptoisolator™	OCXPro™	SMART START™	UltraFET®
Bottomless™	GTO™	OPTOLOGIC®	SPM™	VCX™
Build it Now™	HiSeC™	OPTOPLANAR™	Stealth™	Wire™
CoolFET™	I <sup>2</sup> C™	PACMAN™	SuperFET™	
CROSSVOLT™	i-Lo™	POP™	SuperSOT™-3	
DOVE™	ImpliedDisconnect™	Power247™	SuperSOT™-6	
EcoSPARK™	IntelliMAX™	PowerEdge™	SuperSOT™-8	
E <sup>2</sup> CMOS™	ISOPLANAR™	PowerSaver™	SyncFET™	
EnSigna™	LittleFET™	PowerTrench®	TCM™	
FACT™	MICROCOUPLER™	QFET®	TinyBoost™	
FAST®	MicroFET™	QS™	TinyBuck™	
FASTr™	MicroPak™	QT Optoelectronics™	TinyPWM™	
FPS™	MICROWIRE™	Quiet Series™	TinyPower™	
FRFET™	MSX™	RapidConfigure™	TinyLogic®	
	MSXPro™	RapidConnect™	TINYOPTO™	
Across the board. Around the world.™		µSerDes™	TruTranslation™	
The Power Franchise®		ScalarPump™	UHC™	
Programmable Active Droop™				

**DISCLAIMER**

FAIRCHILD SEMICONDUCTOR RESERVES THE RIGHT TO MAKE CHANGES WITHOUT FURTHER NOTICE TO ANY PRODUCTS HEREIN TO IMPROVE RELIABILITY, FUNCTION OR DESIGN. FAIRCHILD DOES NOT ASSUME ANY LIABILITY ARISING OUT OF THE APPLICATION OR USE OF ANY PRODUCT OR CIRCUIT DESCRIBED HEREIN; NEITHER DOES IT CONVEY ANY LICENSE UNDER ITS PATENT RIGHTS, NOR THE RIGHTS OF OTHERS. THESE SPECIFICATIONS DO NOT EXPAND THE TERMS OF FAIRCHILD'S WORLDWIDE TERMS AND CONDITIONS, SPECIFICALLY THE WARRANTY THEREIN, WHICH COVERS THESE PRODUCTS.

**LIFE SUPPORT POLICY**

FAIRCHILD'S PRODUCTS ARE NOT AUTHORIZED FOR USE AS CRITICAL COMPONENTS IN LIFE SUPPORT DEVICES OR SYSTEMS WITHOUT THE EXPRESS WRITTEN APPROVAL OF FAIRCHILD SEMICONDUCTOR CORPORATION.

As used herein:

1. Life support devices or systems are devices or systems which, (a) are intended for surgical implant into the body, or (b) support or sustain life, or (c) whose failure to perform when properly used in accordance with instructions for use provided in the labeling, can be reasonably expected to result in significant injury to the user.
2. A critical component is any component of a life support device or system whose failure to perform can be reasonably expected to cause the failure of the life support device or system, or to affect its safety or effectiveness.

**PRODUCT STATUS DEFINITIONS**

**Definition of Terms**

Datasheet Identification	Product Status	Definition
Advance Information	Formative or In Design	This datasheet contains the design specifications for product development. Specifications may change in any manner without notice.
Preliminary	First Production	This datasheet contains preliminary data, and supplementary data will be published at a later date. Fairchild Semiconductor reserves the right to make changes at any time without notice in order to improve design.
No Identification Needed	Full Production	This datasheet contains final specifications. Fairchild Semiconductor reserves the right to make changes at any time without notice in order to improve design.
Obsolete	Not In Production	This datasheet contains specifications on a product that has been discontinued by Fairchild semiconductor. The datasheet is printed for reference information only.

Rev. I20





## Стандарт Электрон Связь

Мы молодая и активно развивающаяся компания в области поставок электронных компонентов. Мы поставляем электронные компоненты отечественного и импортного производства напрямую от производителей и с крупнейших складов мира.

Благодаря сотрудничеству с мировыми поставщиками мы осуществляем комплексные и плановые поставки широчайшего спектра электронных компонентов.

Собственная эффективная логистика и склад в обеспечивает надежную поставку продукции в точно указанные сроки по всей России.

Мы осуществляем техническую поддержку нашим клиентам и предпродажную проверку качества продукции. На все поставляемые продукты мы предоставляем гарантию .

Осуществляем поставки продукции под контролем ВП МО РФ на предприятия военно-промышленного комплекса России , а также работаем в рамках 275 ФЗ с открытием отдельных счетов в уполномоченном банке. Система менеджмента качества компании соответствует требованиям ГОСТ ISO 9001.

Минимальные сроки поставки, гибкие цены, неограниченный ассортимент и индивидуальный подход к клиентам являются основой для выстраивания долгосрочного и эффективного сотрудничества с предприятиями радиоэлектронной промышленности, предприятиями ВПК и научно-исследовательскими институтами России.

С нами вы становитесь еще успешнее!

### Наши контакты:

**Телефон:** +7 812 627 14 35

**Электронная почта:** [sales@st-electron.ru](mailto:sales@st-electron.ru)

**Адрес:** 198099, Санкт-Петербург,  
Промышленная ул, дом № 19, литера Н,  
помещение 100-Н Офис 331