

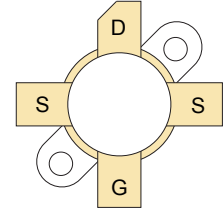

RF POWER VERTICAL MOSFET

The VRF2944 is a gold-metallized silicon n-channel RF power transistor designed for broadband commercial and military applications requiring high power and gain without compromising reliability, ruggedness, or inter-modulation distortion.



FEATURES

- Improved Ruggedness $V_{(BR)DSS} = 170V$
- 400W with 22dB Typ. Gain @ 30MHz, 50V
- Excellent Stability & Low IMD
- Common Source Configuration
- Available in Matched Pairs
- 3:1 Load VSWR Capability at Specified Operating Conditions
- Nitride Passivated
- Refractory Gold Metallization
- Higher Power Version of VRF2933
- Thermally Enhanced Package
- RoHS Compliant 

Maximum Ratings

 All Ratings: $T_c = 25^\circ C$ unless otherwise specified

Symbol	Parameter	VRF2933(MP)	Unit
V_{DSS}	Drain-Source Voltage	170	V
I_D	Continuous Drain Current @ $T_c = 25^\circ C$	50	A
V_{GS}	Gate-Source Voltage	± 40	V
P_D	Total Device dissipation @ $T_c = 25^\circ C$	795	W
T_{STG}	Storage Temperature Range	-65 to 150	°C
T_J	Operating Junction Temperature Max	200	

Static Electrical Characteristics

Symbol	Parameter	Min	Typ	Max	Unit
$V_{(BR)DSS}$	Drain-Source Breakdown Voltage ($V_{GS} = 0V, I_D = 100mA$)	170	180		V
$V_{DS(ON)}$	On State Drain Voltage ($I_{D(ON)} = 25A, V_{GS} = 10V$)		1.7	2.1	
I_{DSS}	Zero Gate Voltage Drain Current ($V_{DS} = 100V, V_{GS} = 0V$)			2.0	mA
I_{GSS}	Gate-Source Leakage Current ($V_{DS} = \pm 20V, V_{GS} = 0V$)			2.0	μA
g_{fs}	Forward Transconductance ($V_{DS} = 10V, I_D = 20A$)	10			mhos
$V_{GS(TH)}$	Gate Threshold Voltage ($V_{DS} = 10V, I_D = 100mA$)	2.9	3.6	4.4	V

Thermal Characteristics

Symbol	Characteristic	Min	Typ	Max	Unit
$R_{\theta JC}$	Junction to Case Thermal Resistance			0.22	°C/W

 **CAUTION:** These Devices are Sensitive to Electrostatic Discharge. Proper Handling Procedures Should Be Followed.

Dynamic Characteristics

VRF2944(MP)

Symbol	Parameter	Test Conditions	Min	Typ	Max	Unit
C_{iss}	Input Capacitance	$V_{GS} = 0V$		1050		pF
C_{oss}	Output Capacitance	$V_{DS} = 50V$		520		
C_{rss}	Reverse Transfer Capacitance	$f = 1MHz$		62		

Functional Characteristics

Symbol	Parameter	Min	Typ	Max	Unit
G_{PS}	$f_1 = 30MHz, V_{DD} = 50V, I_{DQ} = 250mA, P_{out} = 400W$	23	25		dB
η_D	$f_1 = 30MHz, V_{DD} = 50V, I_{DQ} = 250mA, P_{out} = 400W$		50		%
Ψ	$f_1 = 30MHz, V_{DD} = 50V, I_{DQ} = 250mA, P_{out} = 400W$ 3:1 VSWR - All Phase Angles	No Degradation in Output Power			

1. To MIL-STD-1311 Version A, test method 2204B, Two Tone, Reference Each Tone

Microsemi reserves the right to change, without notice, the specifications and information contained herein.

Typical Performance Curves

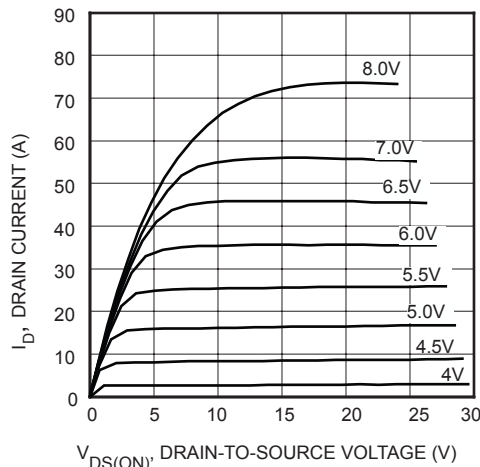

FIGURE 1, Output Characteristics

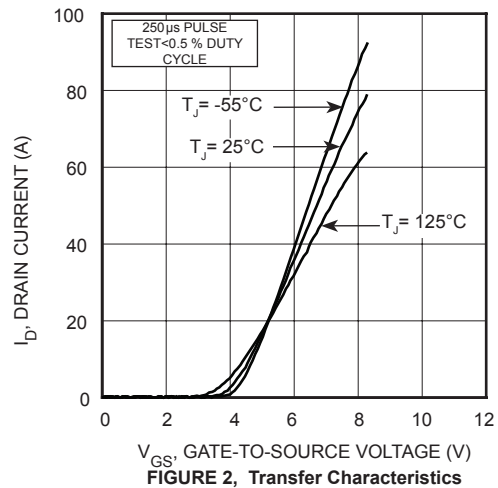

FIGURE 2, Transfer Characteristics

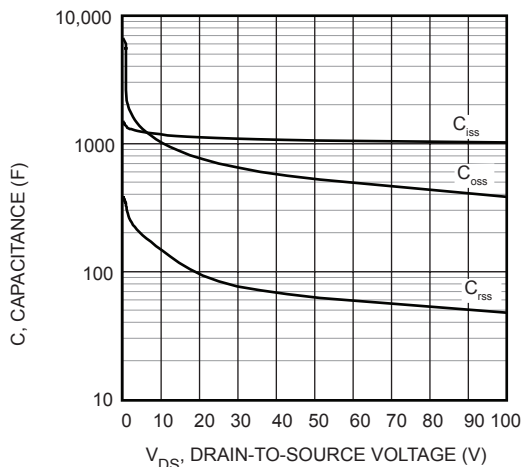

FIGURE 3, Capacitance vs Drain-to-Source Voltage

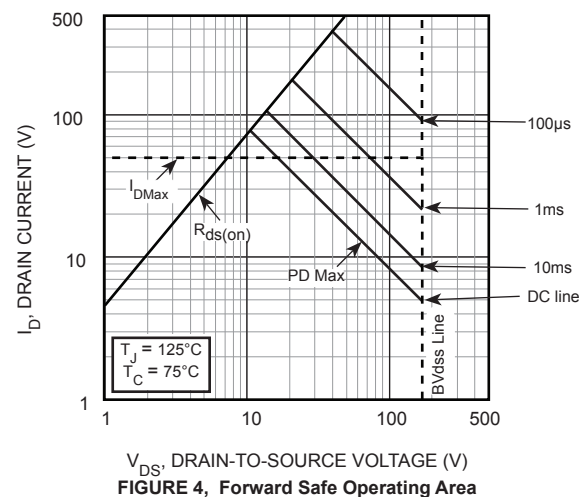

FIGURE 4, Forward Safe Operating Area

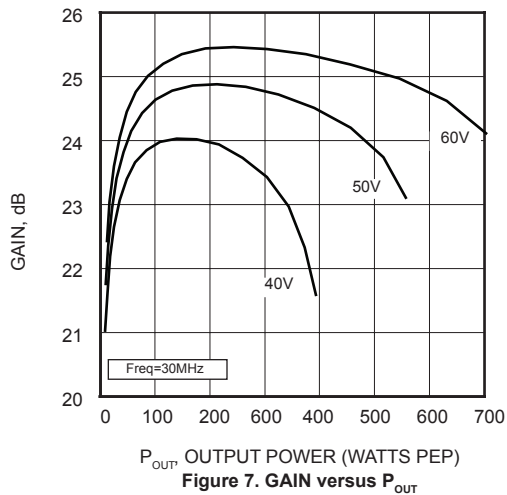
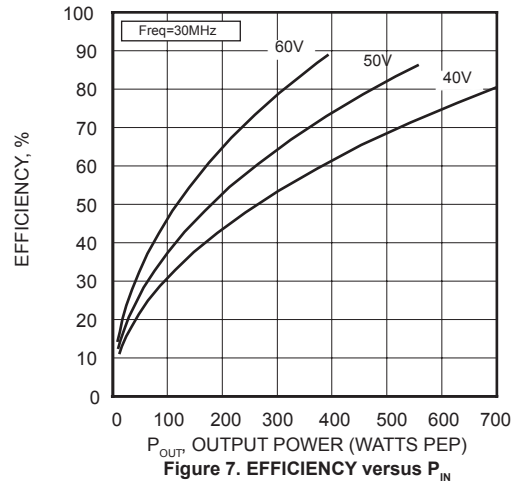
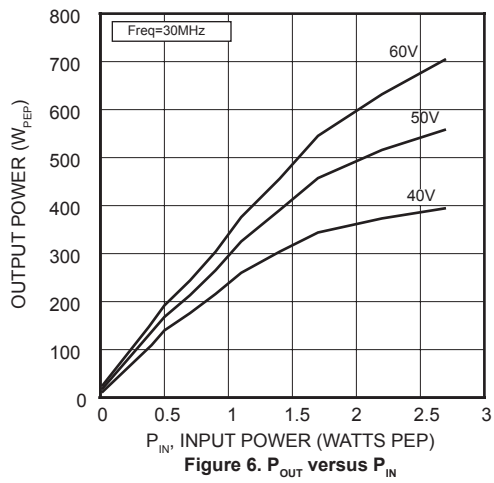
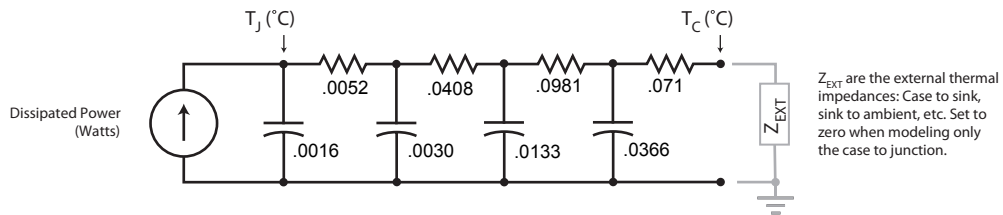
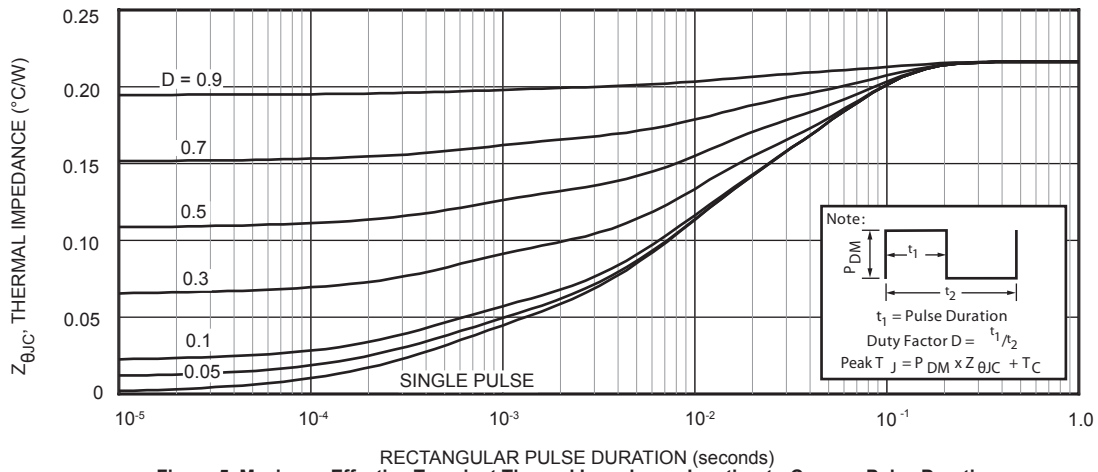
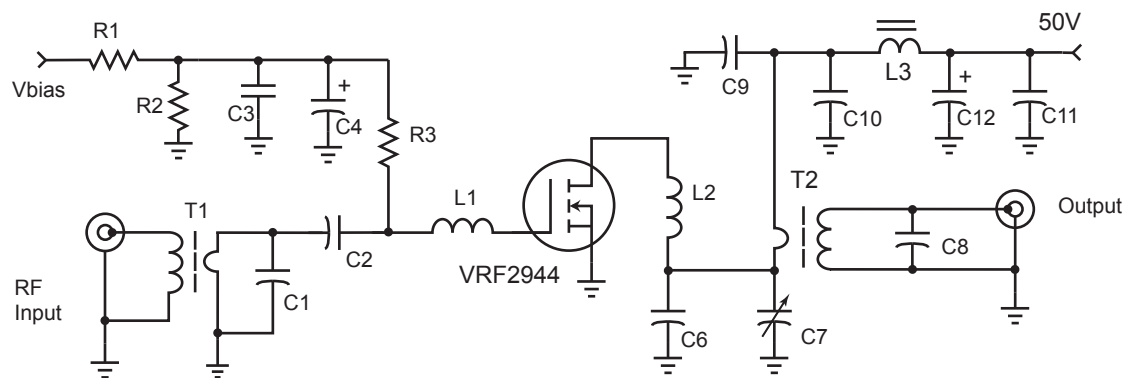

Table 1 - Typical Class AB Large Signal Input - Output Impedance

Freq. (MHz)	Z_{in}	Z_{out}
30	$4.5 - j 2.5$	$2.15 - j 2.71$

$I_{dq} = 100\text{mA}$ Z_{ol} - Conjugate of optimum load for 400 Watts output at $V_{dd}=150\text{V}$

30 MHz Test Circuit



C1 1200pF ATC100B ceramic
 C2, C3 0.1uF 100V 1206 SMT
 C9-C11 .047uF NPO 100V 1218 SMT
 C6 180 pF metal clad mica
 C7 ARCO 465 mica trimmer
 C8 100 pF ATC 100E ceramic
 C4, C12 10uF 100V Electrolytic
 L1 25 nH - 2t #18 0.2"d .2"l

L2 26 nH - 1.5t #12 0.31"d2
 L3 2t #16 on 2x 267300081 .5" bead
 R1-R2 1k Ω 1/4W
 R3 100 Ω 1W
 T1 16:1 transformer 4t #24 teflon on
 RF Parts Co. T1/2 transformer core
 T2 9:1 transformer 3t 2-ply #16 teflon on
 RF Parts Co. T1 transformer core

Adding MP at the end of P/N specifies a matched pair where $V_{GS(TH)}$ is matched between the two parts. V_{TH} values are marked on the devices per the following table.

Code	Vth Range	Code 2	Vth Range
A	2.900 - 2.975	M	3.650 - 3.725
B	2.975 - 3.050	N	3.725 - 3.800
C	3.050 - 3.125	P	3.800 - 3.875
D	3.125 - 3.200	R	3.875 - 3.950
E	3.200 - 3.275	S	3.950 - 4.025
F	3.275 - 3.350	T	4.025 - 4.100
G	3.350 - 3.425	W	4.100 - 4.175
H	3.425 - 3.500	X	4.175 - 4.250
J	3.500 - 3.575	Y	4.250 - 4.325
K	3.575 - 3.650	Z	4.325 - 4.400

V_{TH} values are based on Microsemi measurements at datasheet conditions with an accuracy of 1.0%.

M177 (0.63 dia. SOE) Mechanical Data
All dimensions are ± 0.005

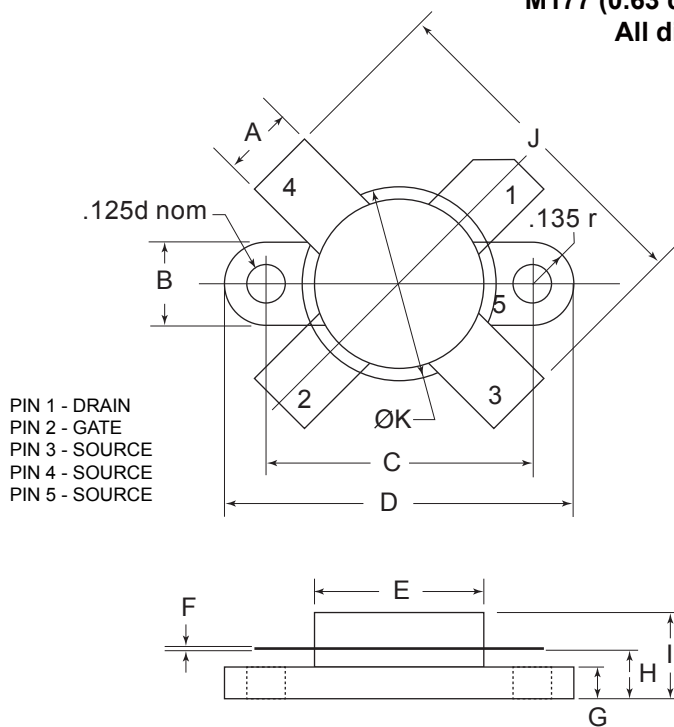

PIN 1 - DRAIN
 PIN 2 - GATE
 PIN 3 - SOURCE
 PIN 4 - SOURCE
 PIN 5 - SOURCE

DIM	MIN	TYP	MAX
A	0.225	0.230	0.235
B	0.265	0.270	0.275
C	0.860	0.865	0.870
D	1.130	1.135	1.140
E	0.545	0.550	0.555
F	0.003	0.005	0.007
G	0.098	0.103	0.108
H	0.150	0.160	0.170
I			0.280
J	1.080	1.100	1.120
K	0.625	0.630	0.635

HAZARDOUS MATERIAL WARNING: The ceramic portion of the device below the lead plane is beryllium oxide. Beryllium oxide dust is highly toxic when inhaled. Care must be taken during handling and mounting to avoid damage to this area. These devices must never be thrown away with general industrial or domestic waste. BeO substrate weight: 0.703g. Percentage of total module weight which is BeO: 9%.

Disclaimer:

The information contained in the document (unless it is publicly available on the Web without access restrictions) is PROPRIETARY AND CONFIDENTIAL information of Microsemi and cannot be copied, published, uploaded, posted, transmitted, distributed or disclosed or used without the express duly signed written consent of Microsemi. If the recipient of this document has entered into a disclosure agreement with Microsemi, then the terms of such Agreement will also apply. This document and the information contained herein may not be modified, by any person other than authorized personnel of Microsemi. No license under any patent, copyright, trade secret or other intellectual property right is granted to or conferred upon you by disclosure or delivery of the information, either expressly, by implication, inducement, estoppels or otherwise. Any license under such intellectual property rights must be approved by Microsemi in writing signed by an officer of Microsemi.

Microsemi reserves the right to change the configuration, functionality and performance of its products at anytime without any notice. This product has been subject to limited testing and should not be used in conjunction with life-support or other mission-critical equipment or applications. Microsemi assumes no liability whatsoever, and Microsemi disclaims any express or implied warranty, relating to sale and/or use of Microsemi products including liability or warranties relating to fitness for a particular purpose, merchantability, or infringement of any patent, copyright or other intellectual property right. Any performance specifications believed to be reliable but are not verified and customer or user must conduct and complete all performance and other testing of this product as well as any user or customers final application. User or customer shall not rely on any data and performance specifications or parameters provided by Microsemi. It is the customer's and user's responsibility to independently determine suitability of any Microsemi product and to test and verify the same. The information contained herein is provided "AS IS, WHERE IS" and with all faults, and the entire risk associated with such information is entirely with the User. Microsemi specifically disclaims any liability of any kind including for consequential, incidental and punitive damages as well as lost profit. The product is subject to other terms and conditions which can be located on the web at <http://www.microsemi.com/legal/tnc.asp>



Стандарт Электрон Связь

Мы молодая и активно развивающаяся компания в области поставок электронных компонентов. Мы поставляем электронные компоненты отечественного и импортного производства напрямую от производителей и с крупнейших складов мира.

Благодаря сотрудничеству с мировыми поставщиками мы осуществляем комплексные и плановые поставки широчайшего спектра электронных компонентов.

Собственная эффективная логистика и склад в обеспечивает надежную поставку продукции в точно указанные сроки по всей России.

Мы осуществляем техническую поддержку нашим клиентам и предпродажную проверку качества продукции. На все поставляемые продукты мы предоставляем гарантию .

Осуществляем поставки продукции под контролем ВП МО РФ на предприятия военно-промышленного комплекса России , а также работаем в рамках 275 ФЗ с открытием отдельных счетов в уполномоченном банке. Система менеджмента качества компании соответствует требованиям ГОСТ ISO 9001.

Минимальные сроки поставки, гибкие цены, неограниченный ассортимент и индивидуальный подход к клиентам являются основой для выстраивания долгосрочного и эффективного сотрудничества с предприятиями радиоэлектронной промышленности, предприятиями ВПК и научно-исследовательскими институтами России.

С нами вы становитесь еще успешнее!

Наши контакты:

Телефон: +7 812 627 14 35

Электронная почта: sales@st-electron.ru

Адрес: 198099, Санкт-Петербург,
Промышленная ул, дом № 19, литера Н,
помещение 100-Н Офис 331