



Micro Commercial Components

Micro Commercial Components
20736 Marilla Street Chatsworth
CA 91311
Phone: (818) 701-4933
Fax: (818) 701-4939

Features

- Through Hole Package
- 150°C Junction Temperature
- Case Material: Molded Plastic. UL Flammability Classification Rating 94V-0 and MSL rating 1
- Marking: Type Number
- Lead Free Finish/Rohs Compliant) ("P" Suffix designates Compliant. See ordering information)

Mechanical Data

- Case: TO-92, Molded Plastic
- Polarity: indicated as below.

Maximum Ratings @ 25°C Unless Otherwise Specified

Charateristic	Symbol	Value	Unit
Collector-Emitter Voltage	BC546 BC547 BC548	65 45 30	V
Collector-Base Voltage	BC546 BC547 BC548	80 50 30	V
Emitter-Base Voltage	V_{EBO}	6.0	V
Collector Current(DC)	I_C	100	mA
Power Dissipation@ $T_A=25^\circ\text{C}$	P_d	625 5.0	mW mW/°C
Power Dissipation@ $T_C=25^\circ\text{C}$	P_d	1.5 12	W mW/°C
Thermal Resistance, Junction to Ambient Air	$R_{\theta JA}$	200	°C/W
Thermal Resistance, Junction to Case	$R_{\theta JC}$	83.3	°C/W
Operating & Storage Temperature	T_j, T_{STG}	-55~150	°C

BC546B

BC547A/B/C

BC548A/B/C

NPN Silicon

Amplifier Transistor

625mW

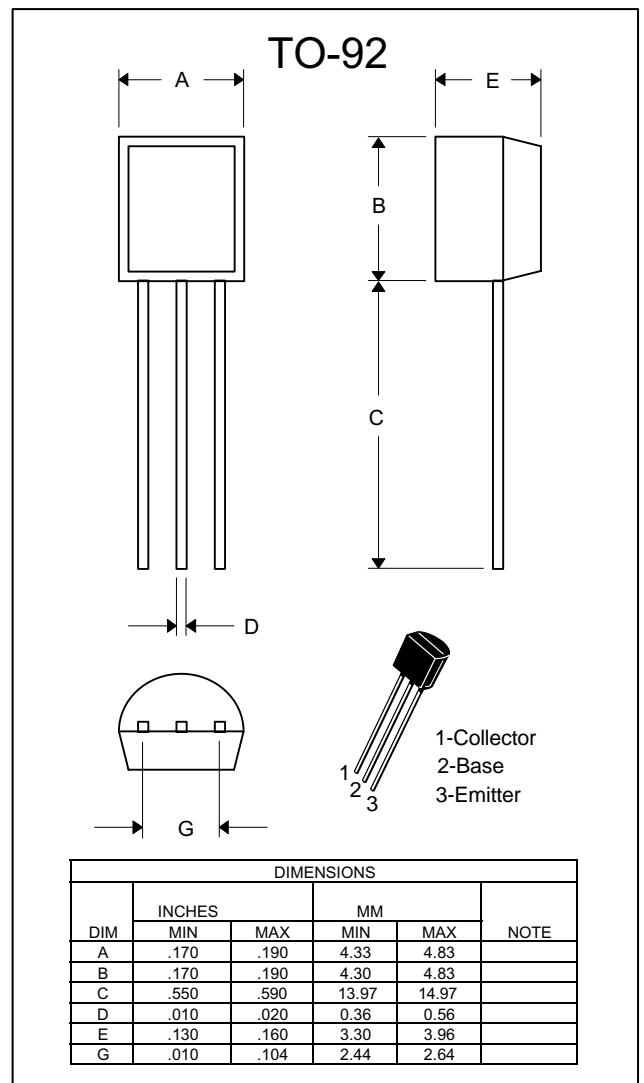

BC546 thru BC548C



ELECTRICAL CHARACTERISTICS (T_A = 25°C unless otherwise noted)

Micro Commercial Components

Characteristic		Symbol	Min	Typ	Max	Unit
OFF CHARACTERISTICS						
Collector–Emitter Breakdown Voltage (I _C = 1.0 mA, I _B = 0)	BC546	V _{(BR)CEO}	65	—	—	V
	BC547		45	—	—	
	BC548		30	—	—	
Collector–Base Breakdown Voltage (I _C = 100 μAdc)	BC546	V _{(BR)CBO}	80	—	—	V
	BC547		50	—	—	
	BC548		30	—	—	
Emitter–Base Breakdown Voltage (I _E = 10 μA, I _C = 0)	BC546	V _{(BR)EBO}	6.0	—	—	V
	BC547		6.0	—	—	
	BC548		6.0	—	—	

ON CHARACTERISTICS

DC Current Gain (I _C = 10 μA, V _{CE} = 5.0 V)	BC547A/548A	h _{FE}	—	90	—	—
	BC546B/547B/548B		—	150	—	
	BC548C		—	270	—	
(I _C = 2.0 mA, V _{CE} = 5.0 V)	BC547A/548A		110	180	220	
	BC546B/547B/548B		200	290	450	
	BC547C/BC548C		420	520	800	
(I _C = 100 mA, V _{CE} = 5.0 V)	BC547A/548A		—	120	—	
	BC546B/547B/548B		—	180	—	
	BC548C		—	300	—	
Collector–Emitter Saturation Voltage (I _C = 100 mA, I _B = 5.0 mA)		V _{CE(sat)}	—	—	0.3	V
Base–Emitter Saturation Voltage (I _C = 100 mA, I _B = 5.0 mA)		V _{BE(sat)}	—	—	1.0	V
Base–Emitter On Voltage (I _C = 2.0 mA, V _{CE} = 5.0 V) (I _C = 10 mA, V _{CE} = 5.0 V)		V _{BE(on)}	0.55	—	0.7	V
			—	—	0.77	

SMALL–SIGNAL CHARACTERISTICS

Current–Gain — Bandwidth Product (I _C = 10 mA, V _{CE} = 5.0 V, f = 100 MHz)	BC546	f _T	150	300	—	MHz
	BC547		150	300	—	
	BC548		150	300	—	
Output Capacitance (V _{CB} = 10 V, I _C = 0, f = 1.0 MHz)		C _{obo}	—	1.7	4.5	pF
Input Capacitance (V _{EB} = 0.5 V, I _C = 0, f = 1.0 MHz)		C _{ibo}	—	10	—	pF
Small–Signal Current Gain (I _C = 2.0 mA, V _{CE} = 5.0 V, f = 1.0 kHz)	BC547A/548A	h _{fe}	125	220	260	—
	BC546B/547B/548B		240	330	500	
	BC547C/548C		450	600	900	
Noise Figure (I _C = 0.2 mA, V _{CE} = 5.0 V, R _S = 2 kΩ, f = 1.0 kHz, Δf = 200 Hz)	BC546	NF	—	2.0	10	dB
	BC547		—	2.0	10	
	BC548		—	2.0	10	

BC546 thru BC548C

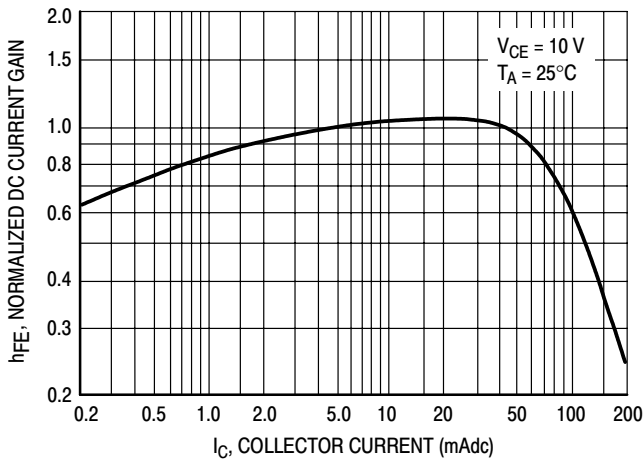

Figure 1. Normalized DC Current Gain

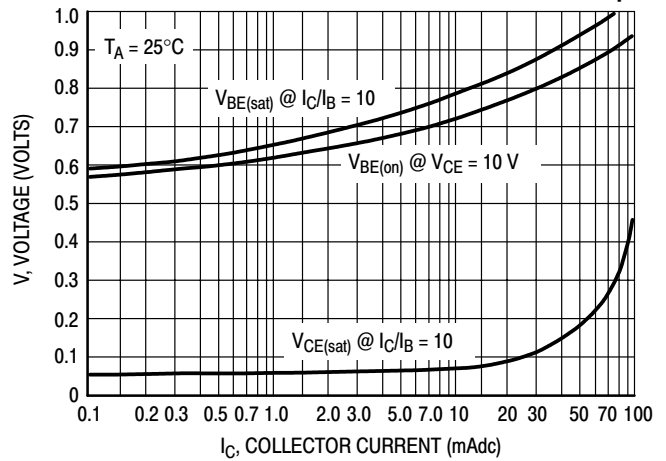

Figure 2. "Saturation" and "On" Voltages

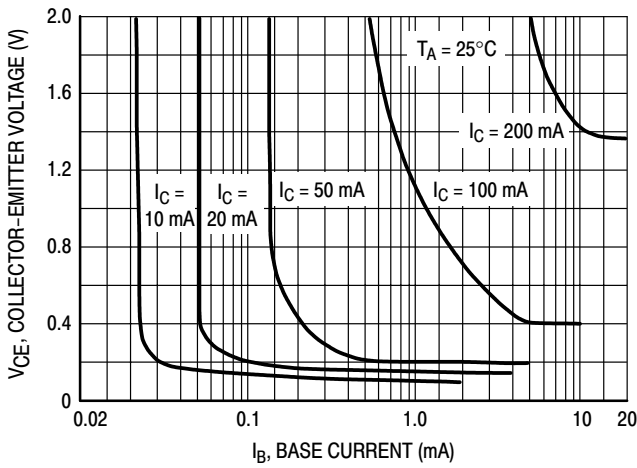

Figure 3. Collector Saturation Region

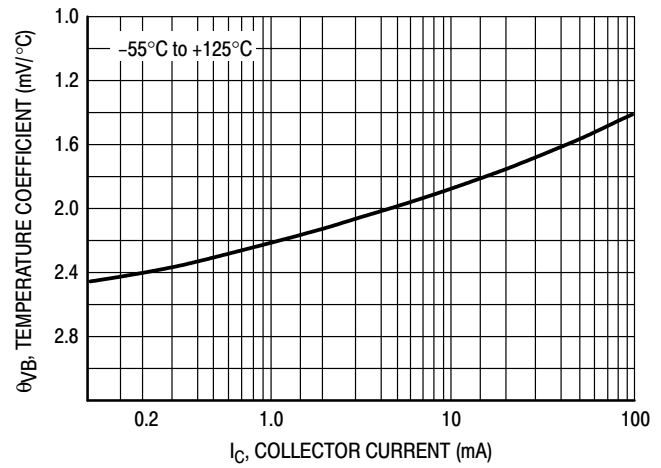

Figure 4. Base-Emitter Temperature Coefficient

BC547/BC548

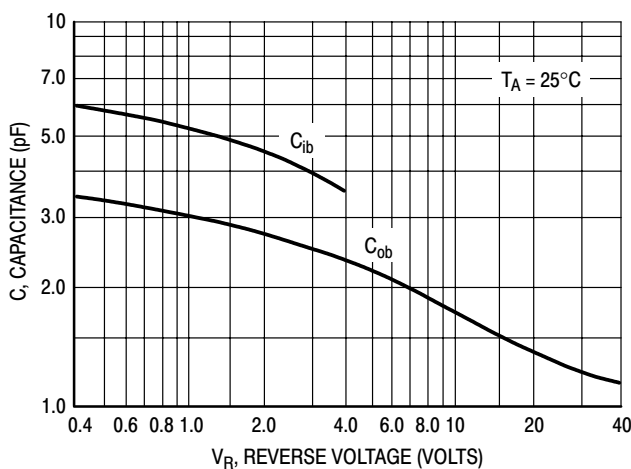

Figure 5. Capacitances

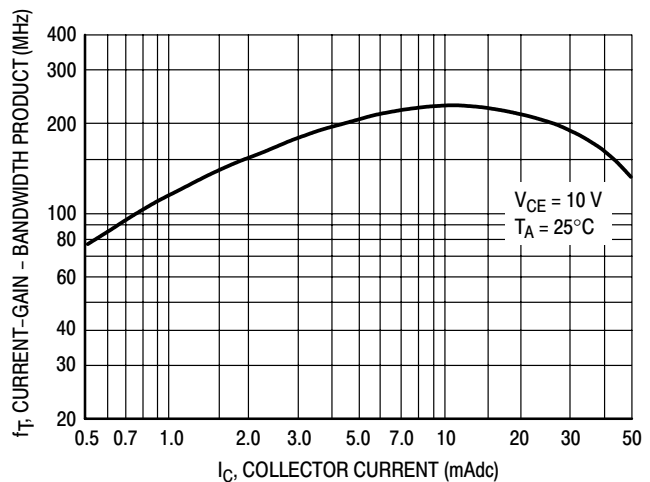

Figure 6. Current-Gain - Bandwidth Product

BC546 thru BC548C

BC547/BC548

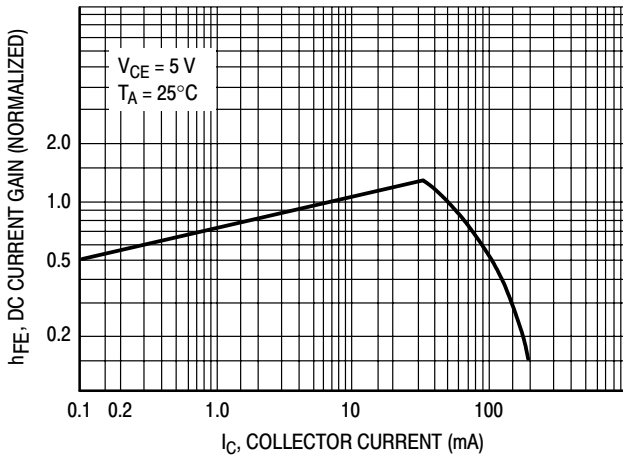

Figure 7. DC Current Gain

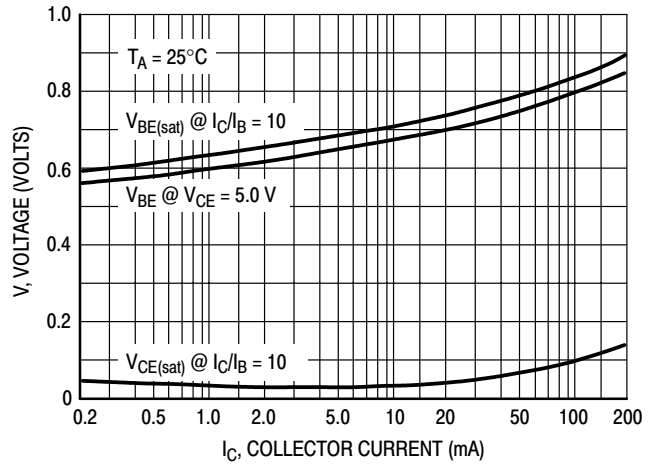

Figure 8. "On" Voltage

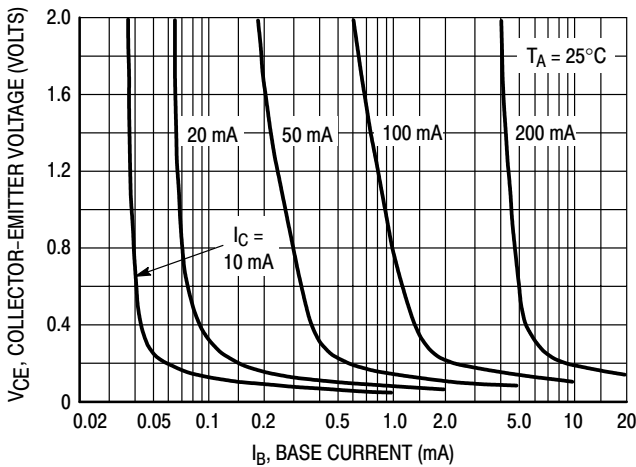

Figure 9. Collector Saturation Region

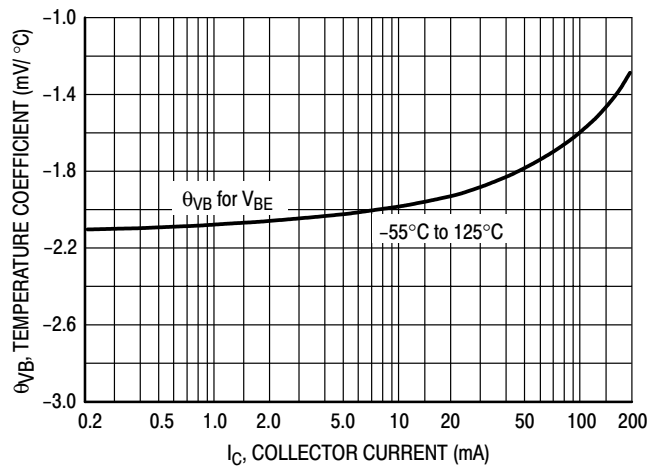

Figure 10. Base-Emitter Temperature Coefficient

BC546

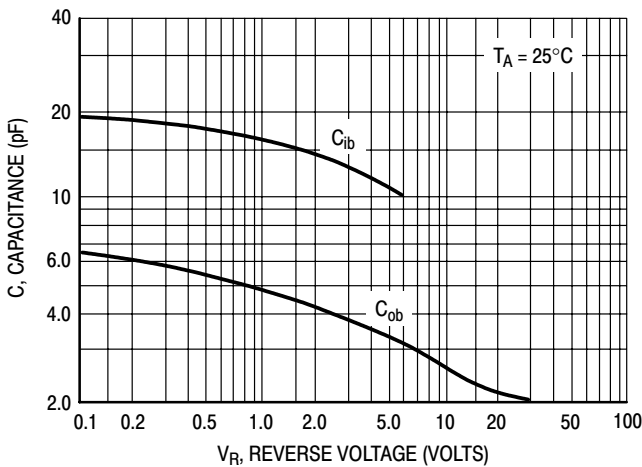

Figure 11. Capacitance

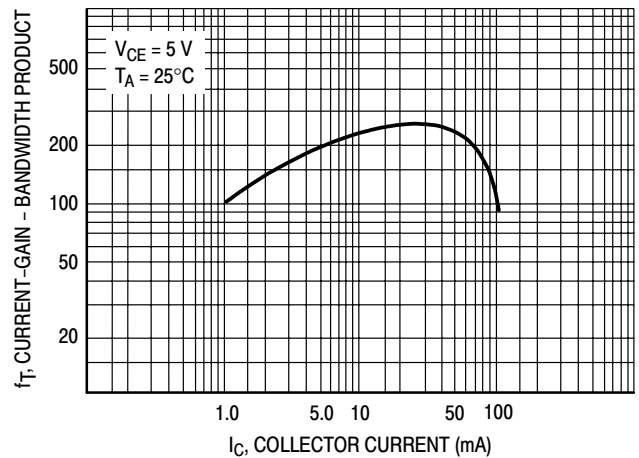

Figure 12. Current-Gain - Bandwidth Product



Micro Commercial Components

Ordering Information

Device	Packing
(Part Number)-AP	Ammo Packing; 2Kpcs/AmmoBox
(Part Number)-BP	Bulk; 1Kpcs/Bag

IMPORTANT NOTICE

Micro Commercial Components Corp. reserves the right to make changes without further notice to any product herein to make corrections, modifications, enhancements, improvements, or other changes. *Micro Commercial Components Corp.* does not assume any liability arising out of the application or use of any product described herein; neither does it convey any license under its patent rights, nor the rights of others. The user of products in such applications shall assume all risks of such use and will agree to hold *Micro Commercial Components Corp.* and all the companies whose products are represented on our website, harmless against all damages.

APPLICATIONS DISCLAIMER

Products offer by *Micro Commercial Components Corp.* are not intended for use in Medical, Aerospace or Military Applications.



Стандарт Электрон Связь

Мы молодая и активно развивающаяся компания в области поставок электронных компонентов. Мы поставляем электронные компоненты отечественного и импортного производства напрямую от производителей и с крупнейших складов мира.

Благодаря сотрудничеству с мировыми поставщиками мы осуществляем комплексные и плановые поставки широчайшего спектра электронных компонентов.

Собственная эффективная логистика и склад в обеспечивает надежную поставку продукции в точно указанные сроки по всей России.

Мы осуществляем техническую поддержку нашим клиентам и предпродажную проверку качества продукции. На все поставляемые продукты мы предоставляем гарантию .

Осуществляем поставки продукции под контролем ВП МО РФ на предприятия военно-промышленного комплекса России , а также работаем в рамках 275 ФЗ с открытием отдельных счетов в уполномоченном банке. Система менеджмента качества компании соответствует требованиям ГОСТ ISO 9001.

Минимальные сроки поставки, гибкие цены, неограниченный ассортимент и индивидуальный подход к клиентам являются основой для выстраивания долгосрочного и эффективного сотрудничества с предприятиями радиоэлектронной промышленности, предприятиями ВПК и научно-исследовательскими институтами России.

С нами вы становитесь еще успешнее!

Наши контакты:

Телефон: +7 812 627 14 35

Электронная почта: sales@st-electron.ru

Адрес: 198099, Санкт-Петербург,
Промышленная ул, дом № 19, литера Н,
помещение 100-Н Офис 331