

# EE-SPX613

CSM\_EE-SPX613\_DS\_E\_5\_1

## Liquid Level Photomicrosensor with operation mode and sensitivity selectors for easy application.

- Operation mode selector allows modes to be switched easily.
- Sensitivity selector is suitable for any 6- to 13-mm-diameter transparent or semi-transparent pipe with a wall thickness of 1 mm.
- Uses a clean (with no powder parting agent) cable.
- Operating voltage range: 12 to 24 VDC



 Be sure to read *Safety Precautions* on page 3.

## Ordering Information

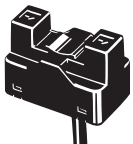
Appearance	Sensing method	Output type	Output configuration	Cable length	Model
	Through-beam type	NPN output	Dark-ON or Light-ON (selectable)	1 m	<b>EE-SPX613 1M</b>

## Ratings and Specifications

Item	Models	EE-SPX613
Applicable pipe		Any 6- to 13-mm-diameter pipe with a wall thickness of 1 mm that is made of FEP or any other material as transparent as FEP.
Sensing object		Liquids in pipes (High-viscosity liquids or liquids with floating materials may not be detected.)
Light source		GaAs infrared LED with a peak wavelength of 940 nm
Indicator		Light indicator GaP (Red LED: Peak wavelength of 700 nm)
Supply voltage		12 to 24 VDC $\pm 10\%$ , ripple (p-p): 5% max.
Current consumption		Average: 30 mA max., Peak: 80 mA max.
Control output		NPN open collector: Load power supply voltage: 5 to 24 VDC Load current: 100 mA max. OFF current: 0.5 mA max. 100 mA load current with a residual voltage of 0.8 V max. 40 mA load current with a residual voltage of 0.4 V max.
Ambient illumination		3,000 lx max. with incandescent light or sunlight on the surface of the receiver
Ambient temperature range		Operating: $-10$ to $+55^{\circ}\text{C}$ Storage: $-25$ to $+65^{\circ}\text{C}$ (with no icing or condensation)
Ambient humidity range		Operating: 5% to 85% Storage: 5% to 95% (with no condensation)
Vibration resistance		Destruction: 10 to 500 Hz, 1.0-mm single amplitude or $150\text{ m/s}^2$ in X, Y, and Z directions 3 times and for 11 min each
Shock resistance		Destruction: $500\text{ m/s}^2$ for 3 times each in X, Y, and Z directions
Degree of protection		IEC 60529 IP50
Connecting method		Pre-wired (Standard length: 1 m)
Weight (packed state)		Approx. 55 g
Material	Case	Polycarbonate
	Cover	
Accessories		Support belt (2), slip protection tube (2), Instruction Manual

## I/O Circuit Diagrams

### NPN Output

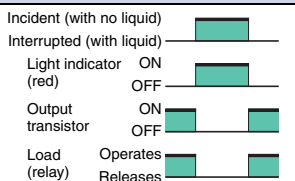
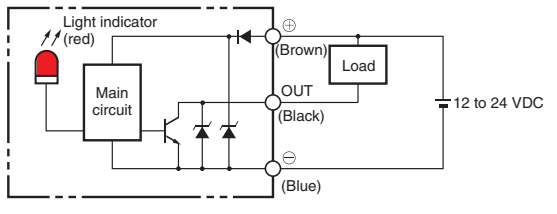
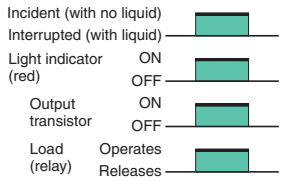
Model	Output configuration	Timing charts	Operation mode selector	Output circuit
EE-SPX613	Dark-ON	Incident (with no liquid) 	D-ON (DARK ON)	
	Light-ON	Incident (with no liquid) 	L-ON (LIGHT ON)	

## Operation

The EE-SPX613 detects the level of liquid by detecting the difference in refractive index between the air and liquid.

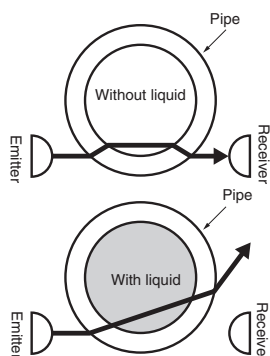

1. If there is no liquid in the pipe, the emitted beam will reach the receiver after it is refracted by the pipe. (Light incident.)
2. If there is liquid in the pipe, the emitted beam will pass through the liquid and not reach the receiver. (Light interrupted.)

### Sensitivity selector (available only with EE-SPX613)

If the diameter of the pipe is close to 6 mm, some of the emitted beam may reach the receiver because the angle of refraction is small, thus making the stable operation of the EE-SPX613 difficult.

In such cases, set the sensitivity selector to Low and check that EE-SPX613 operation is stable.

If there are floating materials on the surface on the liquid, some of the emitted beam may reach the receiver after it is reflected by the floating materials, thus making the stable operation of the EE-SPX613 difficult. In such cases, set the sensitivity selector to Low to stabilize operation.

For normal use, set the sensitivity selector to High to account for reduced sensitivity caused by deterioration of the emitter due to age and stains on the pipe.

## Safety Precautions

Refer to *Warranty and Limitations of Liability*.

### ⚠ WARNING

This product is not designed or rated for ensuring safety of persons either directly or indirectly. Do not use it for such purposes.



### Precautions for Correct Use

Make sure that this product is used within the rated ambient environment conditions.

#### ● Nomenclature

#### EE-SPX613

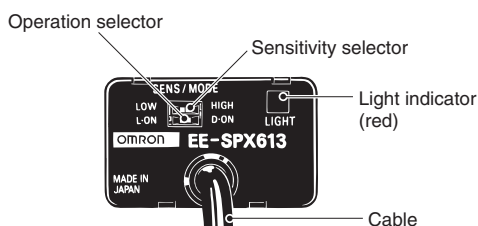

#### ● Mounting

- The EE-SPX613 may not operate correctly if it is attached to an unsuitable pipe (e.g., opaque pipe).
- Always use the supporting belts and slip protection tubes that are provided with the EE-SPX613 when attaching the EE-SPX613 to a pipe, as shown in the following illustration, and make sure that the pipe is in the center of the sensor slot and not separated from the pedestal. When tightening the supporting belts, make sure that the pipe will not be deformed.

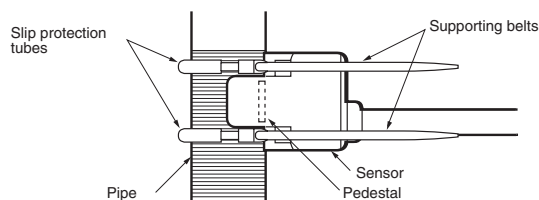

- When attaching the EE-SPX613 to a pipe with a supporting belt, make sure that the pipe will not be deformed.

#### ● Wiring

- Do not impose any excessive force on the cable. Do not pull the cable with any tractive force exceeding 30 N.
- When extending the cable, use an extension cable with conductors

having a total cross-section area of 0.15 mm<sup>2</sup>. The total cable length must be 5 m maximum.

#### ● Adjustment

- The EE-SPX613 requires 10 ms to be in stable operation after power is supplied. If separate power supplies are used for the EE-SPX613 and load, be sure to supply power to the EE-SPX613 before supplying power to the load.
- Make sure that smoke, air bubbles, or water droplets are not able to form either inside or outside the pipe. Otherwise, a malfunction may occur.
- Do not impose any force exceeding 5 N on the operation mode selector or sensitivity selector.

#### ● Others

#### Operating Environment

- Do not use the EE-SPX613 outdoors.
- Do not use the EE-SPX613 in places where water, oil, or chemical may be sprayed onto the EE-SPX613. The exterior coverings of the EE-SPX613 are made of polycarbonate. Keep the coverings away from any alkaline, aromatic hydrocarbon, or aliphatic chloride hydrocarbon solvents, all of which will damage the coverings.
- Do not use the EE-SPX613 in places where the EE-SPX613 is subject to direct sunlight, corrosive gas or salt air.

## Dimensions

Tolerance class IT16 applies to dimensions in this datasheet unless otherwise specified.

### EE-SPX613

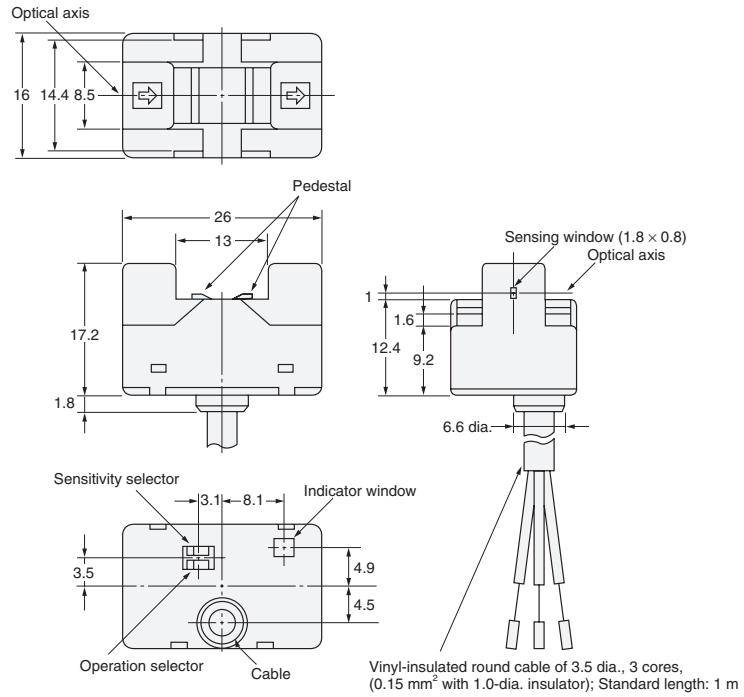

## Read and Understand This Catalog

Please read and understand this catalog before purchasing the products. Please consult your OMRON representative if you have any questions or comments.

## Warranty and Limitations of Liability

### WARRANTY

OMRON's exclusive warranty is that the products are free from defects in materials and workmanship for a period of one year (or other period if specified) from date of sale by OMRON.

OMRON MAKES NO WARRANTY OR REPRESENTATION, EXPRESS OR IMPLIED, REGARDING NON-INFRINGEMENT, MERCHANTABILITY, OR FITNESS FOR PARTICULAR PURPOSE OF THE PRODUCTS. ANY BUYER OR USER ACKNOWLEDGES THAT THE BUYER OR USER ALONE HAS DETERMINED THAT THE PRODUCTS WILL SUITABLY MEET THE REQUIREMENTS OF THEIR INTENDED USE. OMRON DISCLAIMS ALL OTHER WARRANTIES, EXPRESS OR IMPLIED.

### LIMITATIONS OF LIABILITY

OMRON SHALL NOT BE RESPONSIBLE FOR SPECIAL, INDIRECT, OR CONSEQUENTIAL DAMAGES, LOSS OF PROFITS OR COMMERCIAL LOSS IN ANY WAY CONNECTED WITH THE PRODUCTS, WHETHER SUCH CLAIM IS BASED ON CONTRACT, WARRANTY, NEGLIGENCE, OR STRICT LIABILITY.

In no event shall the responsibility of OMRON for any act exceed the individual price of the product on which liability is asserted.

IN NO EVENT SHALL OMRON BE RESPONSIBLE FOR WARRANTY, REPAIR, OR OTHER CLAIMS REGARDING THE PRODUCTS UNLESS OMRON'S ANALYSIS CONFIRMS THAT THE PRODUCTS WERE PROPERLY HANDLED, STORED, INSTALLED, AND MAINTAINED AND NOT SUBJECT TO CONTAMINATION, ABUSE, MISUSE, OR INAPPROPRIATE MODIFICATION OR REPAIR.

## Application Considerations

### SUITABILITY FOR USE

OMRON shall not be responsible for conformity with any standards, codes, or regulations that apply to the combination of products in the customer's application or use of the products.

At the customer's request, OMRON will provide applicable third party certification documents identifying ratings and limitations of use that apply to the products. This information by itself is not sufficient for a complete determination of the suitability of the products in combination with the end product, machine, system, or other application or use.

The following are some examples of applications for which particular attention must be given. This is not intended to be an exhaustive list of all possible uses of the products, nor is it intended to imply that the uses listed may be suitable for the products:

- Outdoor use, uses involving potential chemical contamination or electrical interference, or conditions or uses not described in this catalog.
- Nuclear energy control systems, combustion systems, railroad systems, aviation systems, medical equipment, amusement machines, vehicles, safety equipment, and installations subject to separate industry or government regulations.
- Systems, machines, and equipment that could present a risk to life or property.

Please know and observe all prohibitions of use applicable to the products.

NEVER USE THE PRODUCTS FOR AN APPLICATION INVOLVING SERIOUS RISK TO LIFE OR PROPERTY WITHOUT ENSURING THAT THE SYSTEM AS A WHOLE HAS BEEN DESIGNED TO ADDRESS THE RISKS, AND THAT THE OMRON PRODUCTS ARE PROPERLY RATED AND INSTALLED FOR THE INTENDED USE WITHIN THE OVERALL EQUIPMENT OR SYSTEM.

### PROGRAMMABLE PRODUCTS

OMRON shall not be responsible for the user's programming of a programmable product, or any consequence thereof.

## Disclaimers

### CHANGE IN SPECIFICATIONS

Product specifications and accessories may be changed at any time based on improvements and other reasons.

It is our practice to change model numbers when published ratings or features are changed, or when significant construction changes are made. However, some specifications of the products may be changed without any notice. When in doubt, special model numbers may be assigned to fix or establish key specifications for your application on your request. Please consult with your OMRON representative at any time to confirm actual specifications of purchased products.

### DIMENSIONS AND WEIGHTS

Dimensions and weights are nominal and are not to be used for manufacturing purposes, even when tolerances are shown.

### PERFORMANCE DATA

Performance data given in this catalog is provided as a guide for the user in determining suitability and does not constitute a warranty. It may represent the result of OMRON's test conditions, and the users must correlate it to actual application requirements. Actual performance is subject to the OMRON Warranty and Limitations of Liability.

### ERRORS AND OMISSIONS

The information in this document has been carefully checked and is believed to be accurate; however, no responsibility is assumed for clerical, typographical, or proofreading errors, or omissions.

2010.8

In the interest of product improvement, specifications are subject to change without notice.

**OMRON Corporation**  
Industrial Automation Company

<http://www.ia.omron.com/>

(c)Copyright OMRON Corporation 2010 All Right Reserved.



## Стандарт Электрон Связь

Мы молодая и активно развивающаяся компания в области поставок электронных компонентов. Мы поставляем электронные компоненты отечественного и импортного производства напрямую от производителей и с крупнейших складов мира.

Благодаря сотрудничеству с мировыми поставщиками мы осуществляем комплексные и плановые поставки широчайшего спектра электронных компонентов.

Собственная эффективная логистика и склад в обеспечивает надежную поставку продукции в точно указанные сроки по всей России.

Мы осуществляем техническую поддержку нашим клиентам и предпродажную проверку качества продукции. На все поставляемые продукты мы предоставляем гарантию .

Осуществляем поставки продукции под контролем ВП МО РФ на предприятия военно-промышленного комплекса России , а также работаем в рамках 275 ФЗ с открытием отдельных счетов в уполномоченном банке. Система менеджмента качества компании соответствует требованиям ГОСТ ISO 9001.

Минимальные сроки поставки, гибкие цены, неограниченный ассортимент и индивидуальный подход к клиентам являются основой для выстраивания долгосрочного и эффективного сотрудничества с предприятиями радиоэлектронной промышленности, предприятиями ВПК и научно-исследовательскими институтами России.

С нами вы становитесь еще успешнее!

### Наши контакты:

**Телефон:** +7 812 627 14 35

**Электронная почта:** [sales@st-electron.ru](mailto:sales@st-electron.ru)

**Адрес:** 198099, Санкт-Петербург,  
Промышленная ул, дом № 19, литера Н,  
помещение 100-Н Офис 331