

**PLEASE CHECK WWW.MOLEX.COM FOR LATEST PART INFORMATION**

**Part Number:** [0752374135](#)  
**Status:** **Active**  
**Overview:** [gbx\\_backplane\\_connector\\_system](#)  
**Description:** 1.85mm by 1.85mm (.073 by .073") Pitch 5-Pair GbX® Backplane Connector System, Right Guide Header, 100 Circuits, Gold (Au) 0.76µm (30µ"), Pin Length 5.55mm (.219")

**Documents:**

[Drawing \(PDF\)](#) [RoHS Certificate of Compliance \(PDF\)](#)  
[Product Specification PS-75221-999 \(PDF\)](#)

**Agency Certification**

UL E29179

**General**

Product Family Backplane Connectors  
 Series [75237](#)  
 Application Backplane  
 Application Tooling Documents [Tooling Manual](http://www.molex.com/pdm_docs/ats/TM-622022099.pdf)  
 Comments Right Guide Header, Keying Position C  
 Component Type PCB Header  
 Overview [gbx\\_backplane\\_connector\\_system](#)  
 Product Name GbX®  
 Style N/A

**Physical**

Circuits (Loaded) 100  
 Circuits (maximum) 100  
 Color - Resin Gray (Dark)  
 Durability (mating cycles max) 200  
 First Mate / Last Break No  
 Flammability 94V-0  
 Guide to Mating Part Yes  
 Keying to Mating Part Yes  
 Material - Metal High Performance Alloy (HPA), Stainless Steel  
 Material - Plating Mating Gold  
 Material - Plating Termination Tin-Lead  
 Material - Resin High Temperature Thermoplastic  
 Number of Columns 10  
 Number of Pairs 5  
 Number of Rows 10  
 Orientation Vertical  
 PC Tail Length (in) 0.091 In  
 PC Tail Length (mm) 2.30 mm  
 PCB Locator No  
 PCB Retention Yes  
 PCB Thickness Recommended (in) 0.063 In  
 PCB Thickness Recommended (mm) 1.60 mm  
 Packaging Type Tray  
 Pitch - Mating Interface (in) 0.073 In  
 Pitch - Mating Interface (mm) 1.85 mm  
 Pitch - Term. Interface (in) 0.073 In  
 Pitch - Term. Interface (mm) 1.85 mm  
 Plating min: Mating (µin) 30  
 Plating min: Mating (µm) 0.76  
 Plating min: Termination (µin) 30

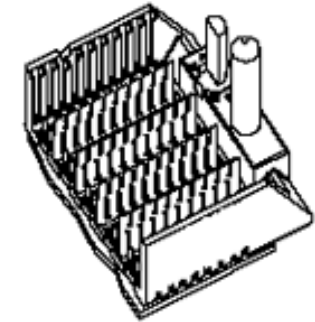

image - Reference only

Series

**EU RoHS**

**RoHS Compliant by Exemption**

**REACH SVHC**

Not Reviewed

**Halogen-Free**

Status

**Not Reviewed**

**China RoHS**



**Need more information on product environmental compliance?**

Email [productcompliance@molex.com](mailto:productcompliance@molex.com)  
 For a multiple part number RoHS Certificate of Compliance, [click here](#)

Please visit the [Contact Us](#) section for any non-product compliance questions.

**Search Parts in this Series**

[75237Series](#)

**Mates With**

[75360 GbX® Daughtercard](#)

**Application Tooling | FAQ**

*Tooling specifications and manuals are found by selecting the products below. Crimp Height Specifications are then contained in the Application Tooling Specification document.*

**Global**

Description	Product #
Insertion Tool, GbX®	<a href="#">0622022030</a>
5 pair by 10 wide	
Insertion Tool, GbX®	<a href="#">0622022040</a>
5 pair by 20 wide	
GbX® Single Pin	<a href="#">0622022090</a>
Repair Tool	
GbX® Shield	<a href="#">0622022100</a>
Removal Tool	

Plating min: Termination (µm)	0.76
Polarized to PCB	No
Stackable	No
Surface Mount Compatible (SMC)	Yes
Temperature Range - Operating	105°C
Termination Interface: Style	Through Hole - Compliant Pin

### **Electrical**

Current - Maximum per Contact	1A
Data Rate	8.0 Gbps
Real Signals (per 25mm)	135
Shield Type	Ground Plane Shield
Shielded	Yes
Voltage - Maximum	120V AC (RMS)/DC

### **Material Info**

#### **Reference - Drawing Numbers**

Product Specification	PS-75221-999
Sales Drawing	SD-75237-410

GbX is a registered trademark of Amphenol Corporation.

This document was generated on 05/13/2010

**PLEASE CHECK [WWW.MOLEX.COM](http://WWW.MOLEX.COM) FOR LATEST PART INFORMATION**

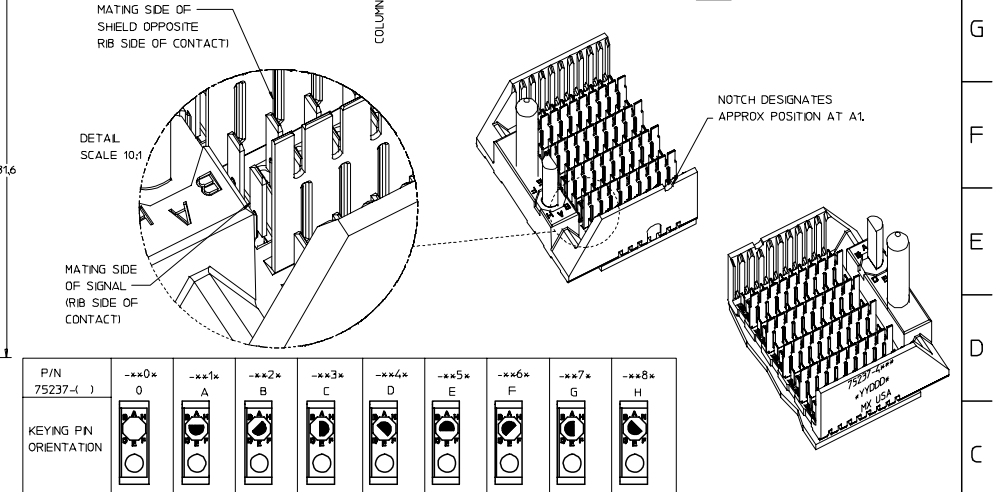
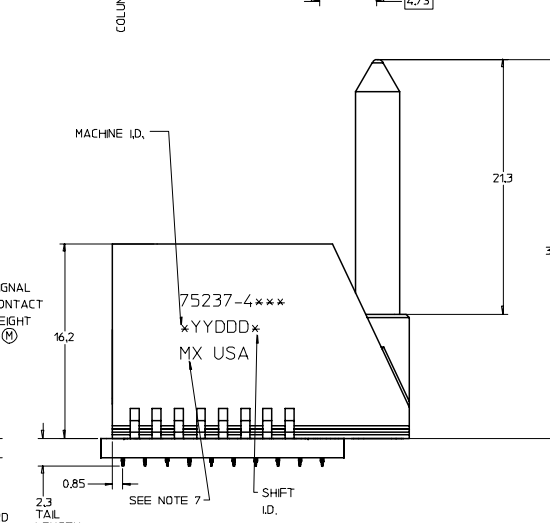
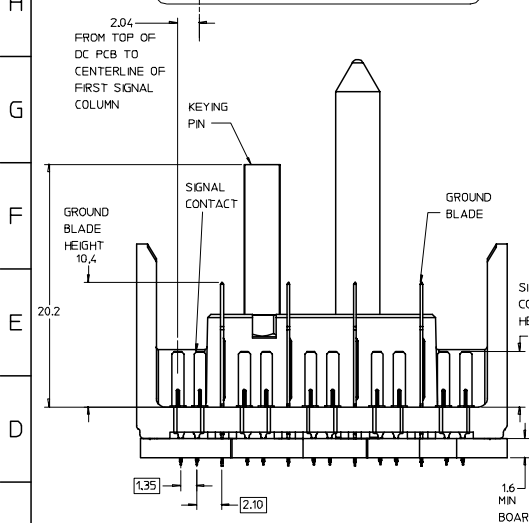
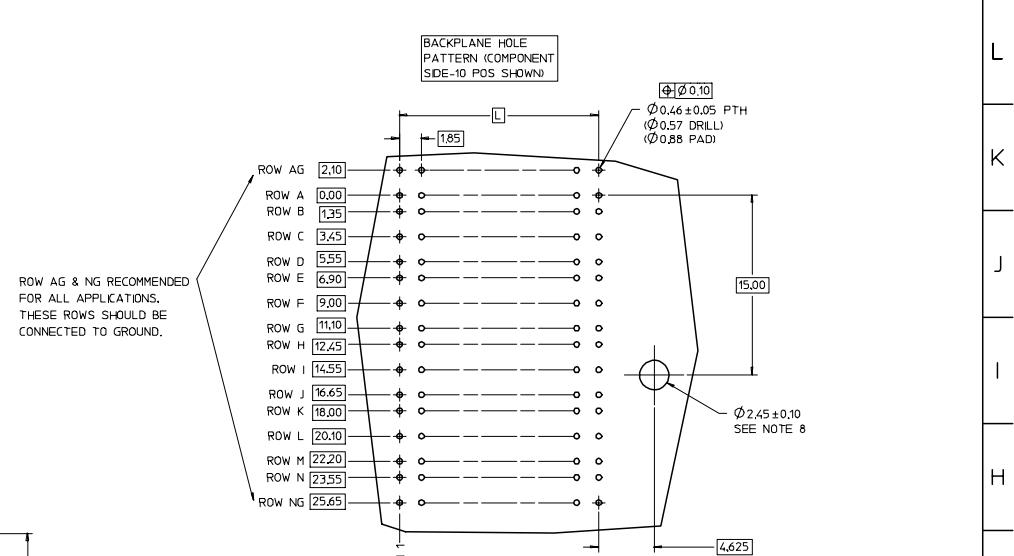
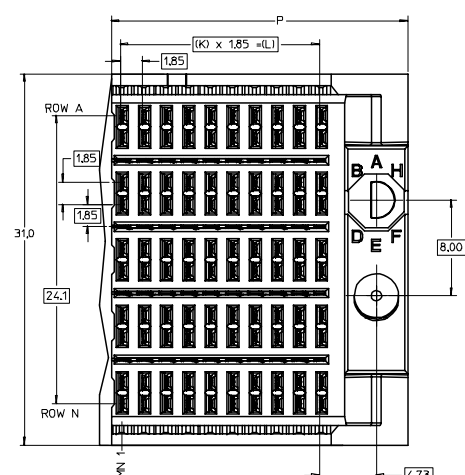
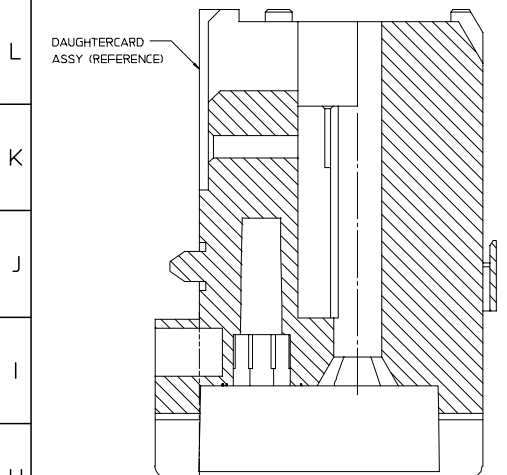

- NOTES:
1. MATERIAL: HOUSING - LIQUID CRYSTAL POLYMER (LCP) GLASS-FILLED, UL 94V-0, COLOR - GRAY. SIGNAL CONTACT AND GROUND BLADE - HIGH PERFORMANCE COPPER ALLOY.
  2. FINISHES: SELECTIVE GOLD (Au) ON CONTACT AREA, SELECTIVE TIN/LEAD (Sn/Pb) ON PCB TAILS, NICKEL (Ni) OVERALL.
  3. THIS PART CONFORMS TO MOLEX PRODUCT SPECIFICATION PS-75221-999.
  4. FOR MIXED CONTACT MATING LENGTHS CONSULT MOLEX FOR AVAILABILITY. CONTACT PAIRS MUST BE THE SAME LENGTH.
  5. FOR SPECIFIC PART NUMBER AND MATING INFORMATION PLEASE REFER TO CHART.
  6. PACKAGE PER PK-70873-565.
  7. EITHER MARK PART NUMBER AND DATE CODE APPROXIMATELY WHERE SHOWN, ON EITHER SIDE OF THE PART, OR PLACE A LABEL ON THE TUBE.
  8. OPTIONAL HOLE LOCATION FOR GROUNDED GUIDE PIN OR ADDITIONAL GUIDE PIN SUPPORT. FOR GROUNDED GUIDE PIN, HOLE TO BE PLATED, DRILL SIZE Ø2.58, PAD SIZE Ø5.50
  9. THESE PARTS CONFORM TO MOLEX COSMETIC SPECIFICATION PS-45499-002 CLASS B.

MODULE ORIENTATION  
4 - RIGHT

75237-4\*\*\*

COLUMN  
1 - 10 COL  
2 - 25 COL

KEYING ORIENTATION (SEE TABLE)

PIN LENGTH DIM "M"  
3-3.55 mm  
4-4.55 mm  
5-5.55 mm

PART NUMBER TABLE				
ASSY PART NO.	K	L	P	TOTAL NO. OF DIFFERENTIAL PAIRS
75237-41**	9	16.65	24.78	50
75237-42**	24	44.40	52.53	125

P/N	-**0*	-**1*	-**2*	-**3*	-**4*	-**5*	-**6*	-**7*	-**8*
75237-( )	0	A	B	C	D	E	F	G	H
KEYING PIN ORIENTATION									

REVISED	QUALITY SYMBOLS	GENERAL TOLERANCES (UNLESS SPECIFIED)		SCALE	DESIGN UNITS	THIRD ANGLE PROJECTION	REVISE ON CAD ONLY		
		mm	INCH	5:1	METRIC				
EC NO: UCP2007-2827 DRWN: JINGHAM 2007/05/10 CHKD: CHYK 2007/05/15 APPR: SREED 2007/05/15	DESCRIPTION	4 PLACES	±---	±---	DIMENSION STYLE MM ONLY	TITLE GBX 5-PAIR RIGHT END BACKPLANE SALES ASSEMBLY	DRAWN BY NMARTIN	DATE 2004/03/16	
		3 PLACES	±---	±---				CHECKED BY SREED	DATE 2004/03/16
		2 PLACES	±---	±---				APPROVED BY CBIXLER	DATE 2004/03/16
		1 PLACE	±---	±---				MATERIAL NO. SEE CHART	DOCUMENT NO. SD-75237-410
		ANGULAR ±---		THIS DRAWING CONTAINS INFORMATION THAT IS PROPRIETARY TO MOLEX INCORPORATED AND SHOULD NOT BE USED WITHOUT WRITTEN PERMISSION					



**Стандарт  
Электрон  
Связь**

Мы молодая и активно развивающаяся компания в области поставок электронных компонентов. Мы поставляем электронные компоненты отечественного и импортного производства напрямую от производителей и с крупнейших складов мира.

Благодаря сотрудничеству с мировыми поставщиками мы осуществляем комплексные и плановые поставки широчайшего спектра электронных компонентов.

Собственная эффективная логистика и склад в обеспечивает надежную поставку продукции в точно указанные сроки по всей России.

Мы осуществляем техническую поддержку нашим клиентам и предпродажную проверку качества продукции. На все поставляемые продукты мы предоставляем гарантию .

Осуществляем поставки продукции под контролем ВП МО РФ на предприятия военно-промышленного комплекса России , а также работаем в рамках 275 ФЗ с открытием отдельных счетов в уполномоченном банке. Система менеджмента качества компании соответствует требованиям ГОСТ ISO 9001.

Минимальные сроки поставки, гибкие цены, неограниченный ассортимент и индивидуальный подход к клиентам являются основой для выстраивания долгосрочного и эффективного сотрудничества с предприятиями радиоэлектронной промышленности, предприятиями ВПК и научно-исследовательскими институтами России.

С нами вы становитесь еще успешнее!

**Наши контакты:**

**Телефон:** +7 812 627 14 35

**Электронная почта:** [sales@st-electron.ru](mailto:sales@st-electron.ru)

**Адрес:** 198099, Санкт-Петербург,  
Промышленная ул, дом № 19, литера Н,  
помещение 100-Н Офис 331