

## FEATURES

- Complete Switch Mode Power Supply
- Wide Input Voltage Range: 4.5V to 20V
- 10A DC, 14A Peak Output Current
- Parallel Two  $\mu$ Module™ DC/DC Converters for 20A Output Current
- 0.6V to 5V Output Voltage
- 1.5% Output Voltage Regulation
- Ultrafast Transient Response
- Current Mode Control
- Pb-Free (e4) RoHS Compliant Package with Gold-Pad Finish
- Up to 92% Efficiency
- Programmable Soft-Start
- Output Overvoltage Protection
- Optional Short-Circuit Shutdown Timer
- Small Footprint, Low Profile (15mm × 15mm × 2.8mm) Surface Mount LGA Package

## APPLICATIONS

- Telecom and Networking Equipment
- Servers
- Industrial Equipment
- Point of Load Regulation

LT, LT, LTC and LTM are registered trademarks of Linear Technology Corporation.  $\mu$ Module is a trademark of Linear Technology Corporation. All other trademarks are the property of their respective owners. Protected by U.S. Patents including 5481178, 6100678, 6580258, 5847554, 6304066.

## DESCRIPTION

The LTM<sup>®</sup>4600 is a complete 10A, DC/DC step down power supply. Included in the package are the switching controller, power FETs, inductor, and all support components. Operating over an input voltage range of 4.5V to 20V, the LTM4600 supports an output voltage range of 0.6V to 5V, set by a single resistor. This high efficiency design delivers 10A continuous current (14A peak), needing no heat sinks or airflow to meet power specifications. Only bulk input and output capacitors are needed to finish the design.

The low profile package (2.8mm) enables utilization of unused space on the bottom of PC boards for high density point of load regulation. High switching frequency and an adaptive on-time current mode architecture enables a very fast transient response to line and load changes without sacrificing stability. Fault protection features include integrated overvoltage and short circuit protection with a defeatable shutdown timer. A built-in soft-start timer is adjustable with a small capacitor.

The LTM4600 is packaged in a thermally enhanced, compact (15mm × 15mm) and low profile (2.8mm) over-molded Land Grid Array (LGA) package suitable for automated assembly by standard surface mount equipment. The LTM4600 is Pb-free and RoHS compliant.

## TYPICAL APPLICATION

10A  $\mu$ Module Power Supply with 4.5V to 20V Input



Efficiency vs Load Current  
 with 12V<sub>IN</sub> (FCB = 0)



4600 TA01b

## ABSOLUTE MAXIMUM RATINGS

(Note 1)

FCB, EXTV <sub>CC</sub> , PGOOD, RUN/SS, V <sub>OUT</sub> .....	-0.3V to 6V
V <sub>IN</sub> , SV <sub>IN</sub> , f <sub>ADJ</sub> .....	-0.3V to 20V
V <sub>OSET</sub> , COMP.....	-0.3V to 2.7V
Operating Temperature Range (Note 2)....	-40°C to 85°C
Junction Temperature.....	125°C
Storage Temperature Range.....	-55°C to 125°C

## PIN CONFIGURATION



## ORDER INFORMATION

LEAD FREE FINISH	PART MARKING	PACKAGE DESCRIPTION	TEMPERATURE RANGE
LTM4600EV#PBF	LTM4600EV	104-Lead (15mm × 15mm × 2.8mm) LGA	-40°C to 85°C
LTM4600IV#PBF	LTM4600IV	104-Lead (15mm × 15mm × 2.8mm) LGA	-40°C to 85°C

Consult LTC Marketing for parts specified with wider operating temperature ranges.

Consult LTC Marketing for information on non-standard lead based finish parts.

For more information on lead free part marking, go to: <http://www.linear.com/leadfree/>

This product is only offered in trays. For more information go to: <http://www.linear.com/packaging/>

**ELECTRICAL CHARACTERISTICS** The ● denotes the specifications which apply over the -40°C to 85°C temperature range, otherwise specifications are at T<sub>A</sub> = 25°C, V<sub>IN</sub> = 12V. External C<sub>IN</sub> = 120μF, C<sub>OUT</sub> = 200μF/Ceramic per typical application (front page) configuration.

SYMBOL	PARAMETER	CONDITIONS	MIN	TYP	MAX	UNITS
V <sub>IN(DC)</sub>	Input DC Voltage		● 4.5		20	V
V <sub>OUT(DC)</sub>	Output Voltage	FCB = 0V V <sub>IN</sub> = 5V or 12V, V <sub>OUT</sub> = 1.5V, I <sub>OUT</sub> = 0A	● 1.478	1.50	1.522	V
			1.470	1.50	1.530	V

### Input Specifications

V <sub>IN(UVLO)</sub>	Under Voltage Lockout Threshold	I <sub>OUT</sub> = 0A		3.4	4	V
I <sub>INRUSH(VIN)</sub>	Input Inrush Current at Startup	I <sub>OUT</sub> = 0A, V <sub>OUT</sub> = 1.5V, FCB = 0 V <sub>IN</sub> = 5V V <sub>IN</sub> = 12V		0.6		A
				0.7		A
I <sub>Q(VIN)</sub>	Input Supply Bias Current	I <sub>OUT</sub> = 0A, EXTV <sub>CC</sub> Open V <sub>IN</sub> = 12V, V <sub>OUT</sub> = 1.5V, FCB = 5V V <sub>IN</sub> = 12V, V <sub>OUT</sub> = 1.5V, FCB = 0V V <sub>IN</sub> = 5V, V <sub>OUT</sub> = 1.5V, FCB = 5V V <sub>IN</sub> = 5V, V <sub>OUT</sub> = 1.5V, FCB = 0V Shutdown, RUN = 0.8V, V <sub>IN</sub> = 12V		1.2		mA
				42		mA
				1.0		mA
				52		mA
				35	75	μA

## ELECTRICAL CHARACTERISTICS

The ● denotes the specifications which apply over the  $-40^{\circ}\text{C}$  to  $85^{\circ}\text{C}$  temperature range, otherwise specifications are at  $T_A = 25^{\circ}\text{C}$ ,  $V_{IN} = 12\text{V}$ . Per typical application (front page) configuration.

SYMBOL	PARAMETER	CONDITIONS	MIN	TYP	MAX	UNITS
$I_{S(VIN)}$	Input Supply Current	$V_{IN} = 12\text{V}$ , $V_{OUT} = 1.5\text{V}$ , $I_{OUT} = 10\text{A}$		1.52		A
		$V_{IN} = 12\text{V}$ , $V_{OUT} = 3.3\text{V}$ , $I_{OUT} = 10\text{A}$		3.13		A
		$V_{IN} = 5\text{V}$ , $V_{OUT} = 1.5\text{V}$ , $I_{OUT} = 10\text{A}$		3.64		A

### Output Specifications

$I_{OUTDC}$	Output Continuous Current Range (See Output Current Derating Curves for Different $V_{IN}$ , $V_{OUT}$ and $T_A$ )	$V_{IN} = 12\text{V}$ , $V_{OUT} = 1.5\text{V}$		0	10	A
$\frac{\Delta V_{OUT(LINE)}}{V_{OUT}}$	Line Regulation Accuracy	$V_{OUT} = 1.5\text{V}$ , $I_{OUT} = 0\text{A}$ , $FCB = 0\text{V}$ , $V_{IN} = 4.5\text{V}$ to $20\text{V}$	●	0.15	0.3	%
$\frac{\Delta V_{OUT(LOAD)}}{V_{OUT}}$	Load Regulation Accuracy	$V_{OUT} = 1.5\text{V}$ , $I_{OUT} = 0\text{A}$ to $10\text{A}$ , $FCB = 0\text{V}$ $V_{IN} = 5\text{V}$ $V_{IN} = 12\text{V}$ (Notes 3, 4)	●		$\pm 1$ $\pm 1.5$	% %
$V_{OUT(AC)}$	Output Ripple Voltage	$V_{IN} = 12\text{V}$ , $V_{OUT} = 1.5\text{V}$ , $I_{OUT} = 0\text{A}$ , $FCB = 0\text{V}$		10	15	mV <sub>p-p</sub>
$f_s$	Output Ripple Voltage Frequency	$V_{OUT} = 1.5\text{V}$ , $I_{OUT} = 5\text{A}$ , $FCB = 0\text{V}$		850		kHz
$t_{START}$	Turn-On Time	$V_{OUT} = 1.5\text{V}$ , $I_{OUT} = 1\text{A}$ $V_{IN} = 12\text{V}$ $V_{IN} = 5\text{V}$		0.5 0.7		ms ms
$\Delta V_{OUTLS}$	Voltage Drop for Dynamic Load Step	$V_{OUT} = 1.5\text{V}$ , Load Step: $0\text{A}/\mu\text{s}$ to $5\text{A}/\mu\text{s}$ $C_{OUT} = 3 \cdot 22\mu\text{F}$ 6.3V, $470\mu\text{F}$ 4V POSCAP, See Table 2		36		mV
$t_{SETTLE}$	Settling Time for Dynamic Load Step	Load: 10% to 90% to 10% of Full Load		25		$\mu\text{s}$
$I_{OUTPK}$	Output Current Limit	Output Voltage in Foldback $V_{IN} = 12\text{V}$ , $V_{OUT} = 1.5\text{V}$ $V_{IN} = 5\text{V}$ , $V_{OUT} = 1.5\text{V}$		14 14		A A

### Control Stage

$V_{OSET}$	Voltage at $V_{OSET}$ Pin	$I_{OUT} = 0\text{A}$ , $V_{OUT} = 1.5\text{V}$	●	0.591 0.594	0.6 0.6	0.609 0.606	V V
$V_{RUN/SS}$	RUN ON/OFF Threshold			0.8	1.5	2	V
$I_{RUN(C)/SS}$	Soft-Start Charging Current	$V_{RUN/SS} = 0\text{V}$		-0.5	-1.2	-3	$\mu\text{A}$
$I_{RUN(D)/SS}$	Soft-Start Discharging Current	$V_{RUN/SS} = 4\text{V}$		0.8	1.8	3	$\mu\text{A}$
$V_{IN} - SV_{IN}$		$EXTV_{CC} = 0\text{V}$ , $FCB = 0\text{V}$			100		mV
$I_{EXTVCC}$	Current into $EXTV_{CC}$ Pin	$EXTV_{CC} = 5\text{V}$ , $FCB = 0\text{V}$ , $V_{OUT} = 1.5\text{V}$ , $I_{OUT} = 0\text{A}$			16		mA
$R_{FBHI}$	Resistor Between $V_{OUT}$ and $V_{OSET}$ Pins				100		k $\Omega$
$V_{FCB}$	Forced Continuous Threshold			0.57	0.6	0.63	V
$I_{FCB}$	Forced Continuous Pin Current	$V_{FCB} = 0.6\text{V}$			-1	-2	$\mu\text{A}$

### PGOOD Output

$\Delta V_{OSETH}$	PGOOD Upper Threshold	$V_{OSET}$ Rising		7.5	10	12.5	%
$\Delta V_{OSETL}$	PGOOD Lower Threshold	$V_{OSET}$ Falling		-7.5	-10	-12.5	%
$\Delta V_{OSET(HYS)}$	PGOOD Hysteresis	$V_{OSET}$ Returning			2		%
$V_{PGL}$	PGOOD Low Voltage	$I_{PGOOD} = 5\text{mA}$			0.15	0.4	V

**Note 1:** Stresses beyond those listed under Absolute Maximum Ratings may cause permanent damage to the device. Exposure to any Absolute Maximum Rating condition for extended periods may affect device reliability and lifetime.

**Note 2:** The LTM4600E is guaranteed to meet performance specifications from  $0^{\circ}\text{C}$  to  $85^{\circ}\text{C}$ . Specifications over the  $-40^{\circ}\text{C}$  to  $85^{\circ}\text{C}$  operating

temperature range are assured by design, characterization and correlation with statistical process controls. The LTM4600I is guaranteed over the  $-40^{\circ}\text{C}$  to  $85^{\circ}\text{C}$  temperature range.

**Note 3:** Test assumes current derating versus temperature.

**Note 4:** Guaranteed by correlation.

## TYPICAL PERFORMANCE CHARACTERISTICS (See Figure 18 for all curves)

**Efficiency vs Load Current with 5V<sub>IN</sub> (FCB = 0)**



4600 G01

**Efficiency vs Load Current with 12V<sub>IN</sub> (FCB = 0)**

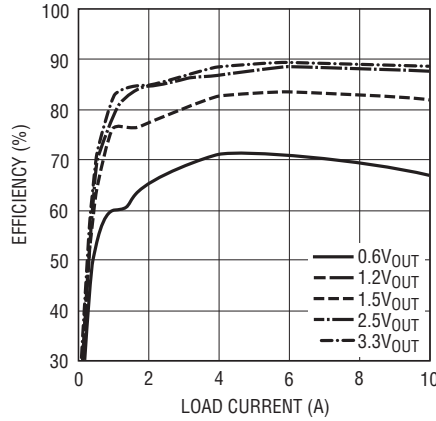

4600 G02

**Efficiency vs Load Current with 18V<sub>IN</sub> (FCB = 0)**

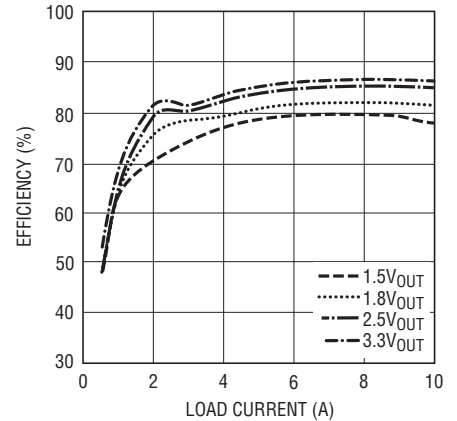

4600 G03

**Efficiency vs Load Current with Different FCB Settings**



4600 G04

**1.2V Transient Response**

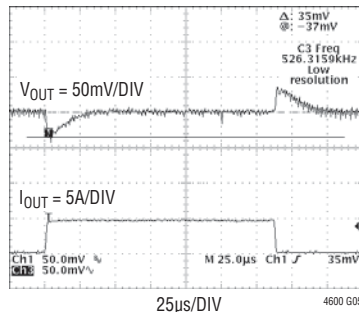

4600 G05

25µs/DIV  
1.2V AT 5A/µs LOAD STEP  
C<sub>OUT</sub> = 3 • 22µF 6.3V CERAMICS  
470µF 4V SANYO POSCAP  
C<sub>3</sub> = 100pF

**1.5V Transient Response**

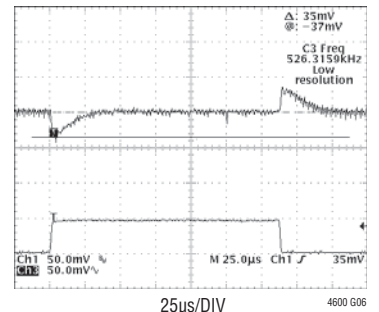

4600 G06

25µs/DIV  
1.5V AT 5A/µs LOAD STEP  
C<sub>OUT</sub> = 3 • 22µF 6.3V CERAMICS  
470µF 4V SANYO POSCAP  
C<sub>3</sub> = 100pF

**1.8V Transient Response**

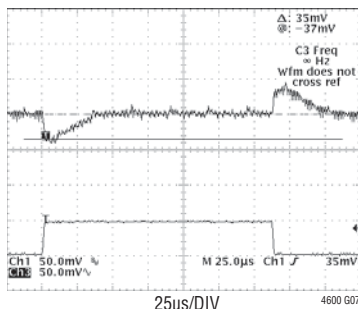

4600 G07

25µs/DIV  
1.8V AT 5A/µs LOAD STEP  
C<sub>OUT</sub> = 3 • 22µF 6.3V CERAMICS  
470µF 4V SANYO POSCAP  
C<sub>3</sub> = 100pF

**2.5V Transient Response**

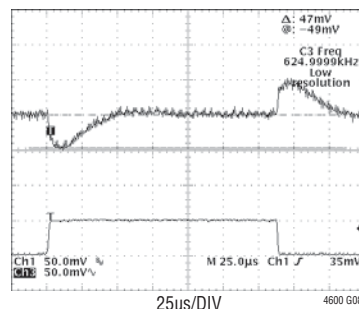

4600 G08

25µs/DIV  
2.5V AT 5A/µs LOAD STEP  
C<sub>OUT</sub> = 3 • 22µF 6.3V CERAMICS  
470µF 4V SANYO POSCAP  
C<sub>3</sub> = 100pF

**3.3V Transient Response**

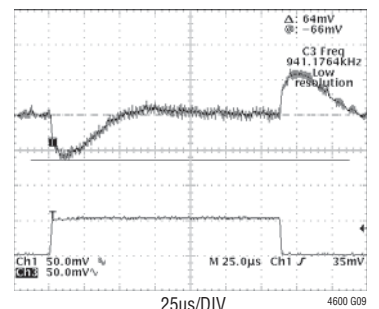

4600 G09

25µs/DIV  
3.3V AT 5A/µs LOAD STEP  
C<sub>OUT</sub> = 3 • 22µF 6.3V CERAMICS  
470µF 4V SANYO POSCAP  
C<sub>3</sub> = 100pF

**TYPICAL PERFORMANCE CHARACTERISTICS** (See Figure 18 for all curves)

**Start-Up,  $I_{OUT} = 0A$**



$V_{IN} = 12V$   
 $V_{OUT} = 1.5V$   
 $C_{OUT} = 200\mu F$   
 NO EXTERNAL SOFT-START CAPACITOR

**Start-Up,  $I_{OUT} = 10A$   
 (Resistive Load)**



$V_{IN} = 12V$   
 $V_{OUT} = 1.5V$   
 $C_{OUT} = 200\mu F$   
 NO EXTERNAL SOFT-START CAPACITOR

**Short-Circuit Protection,  
 $I_{OUT} = 0A$**



$V_{IN} = 12V$   
 $V_{OUT} = 1.5V$   
 $C_{OUT} = 2 \times 200\mu F / X5R$   
 NO EXTERNAL SOFT-START CAPACITOR

**Short-Circuit Protection,  
 $I_{OUT} = 10A$**



$V_{IN} = 12V$   
 $V_{OUT} = 1.5V$   
 $C_{OUT} = 2 \times 200\mu F / X5R$   
 NO EXTERNAL SOFT-START CAPACITOR

**$V_{IN}$  to  $V_{OUT}$  Step-Down Ratio**



SEE FREQUENCY ADJUSTMENT DISCUSSION FOR  $12V_{IN}$  TO  $5V_{OUT}$  AND  $5V_{IN}$  TO  $3.3V_{OUT}$  CONVERSION

**12V Input Load Regulation vs Temperature**



4600 G15

## PIN FUNCTIONS (See Package Description for Pin Assignment)

**$V_{IN}$  (Bank 1):** Power Input Pins. Apply input voltage between these pins and PGND pins. Recommend placing input decoupling capacitance directly between  $V_{IN}$  pins and PGND pins.

**$f_{ADJ}$  (Pin A15):** A 110k resistor from  $V_{IN}$  to this pin sets the one-shot timer current, thereby setting the switching frequency. The LTM4600 switching frequency is typically 850kHz. An external resistor to ground can be selected to reduce the one-shot timer current, thus lower the switching frequency to accommodate a higher duty cycle step down requirement. See the applications section.

**$SV_{IN}$  (Pin A17):** Supply Pin for Internal PWM Controller. Leave this pin open or add additional decoupling capacitance.

**$EXTV_{CC}$  (Pin A19):** External 5V supply pin for controller. If left open or grounded, the internal 5V linear regulator will power the controller and MOSFET drivers. For high input voltage applications, connecting this pin to an external 5V will reduce the power loss in the power module. The  $EXTV_{CC}$  voltage should never be higher than  $V_{IN}$ .

**$V_{OSET}$  (Pin A21):** The Negative Input of The Error Amplifier. Internally, this pin is connected to  $V_{OUT}$  with a 100k precision resistor. Different output voltages can be programmed with additional resistors between the  $V_{OSET}$  and SGND pins.

**COMP (Pin B23):** Current Control Threshold and Error Amplifier Compensation Point. The current comparator threshold increases with this control voltage. The voltage ranges from 0V to 2.4V with 0.8V corresponding to zero sense voltage (zero current).

**SGND (Pin D23):** Signal Ground Pin. All small-signal components should connect to this ground, which in turn connects to PGND at one point.

**RUN/SS (Pin F23):** Run and Soft-Start Control. Forcing this pin below 0.8V will shut down the power supply. Inside the power module, there is a 1000pF capacitor which provides approximately 0.7ms soft-start time with 200 $\mu$ F output capacitance. Additional soft-start time can be achieved by adding additional capacitance between the RUN/SS and SGND pins. The internal short-circuit latching can be disabled by adding a resistor between this pin and the  $V_{IN}$  pin. This pullup resistor must supply a minimum 5 $\mu$ A pull up current.

**FCB (Pin G23):** Forced Continuous Input. Grounding this pin enables forced continuous mode operation regardless of load conditions. Tying this pin above 0.63V enables discontinuous conduction mode to achieve high efficiency operation at light loads. There is an internal 4.75K resistor between the FCB and SGND pins.

**PGOOD (Pin J23):** Output Voltage Power Good Indicator. When the output voltage is within 10% of the nominal voltage, the PGOOD is open drain output. Otherwise, this pin is pulled to ground.

**PGND (Bank 2):** Power ground pins for both input and output returns.

**$V_{OUT}$  (Bank 3):** Power Output Pins. Apply output load between these pins and PGND pins. Recommend placing High Frequency output decoupling capacitance directly between these pins and PGND pins.



## SIMPLIFIED BLOCK DIAGRAM



Figure 1. Simplified LTM4600 Block Diagram

## DECOUPLING REQUIREMENTS $T_A = 25^\circ\text{C}$ , $V_{IN} = 12\text{V}$ . Use Figure 1 configuration.

SYMBOL	PARAMETER	CONDITIONS	MIN	TYP	MAX	UNITS
C <sub>IN</sub>	External Input Capacitor Requirement ( $V_{IN} = 4.5\text{V to } 20\text{V}$ , $V_{OUT} = 1.5\text{V}$ )	$I_{OUT} = 10\text{A}$	20			μF
C <sub>OUT</sub>	External Output Capacitor Requirement ( $V_{IN} = 4.5\text{V to } 20\text{V}$ , $V_{OUT} = 1.5\text{V}$ )	$I_{OUT} = 10\text{A}$ , Refer to Table 2 in the Applications Information Section	100	200		μF

## OPERATION

### μModule Description

The LTM4600 is a standalone non-isolated synchronous switching DC/DC power supply. It can deliver up to 10A of DC output current with only bulk external input and output capacitors. This module provides a precisely regulated output voltage programmable via one external resistor from  $0.6V_{DC}$  to  $5.0V_{DC}$ , not to exceed 80% of the input voltage. The input voltage range is 4.5V to 20V. A simplified block diagram is shown in Figure 1 and the typical application schematic is shown in Figure 18.

The LTM4600 contains an integrated LTC constant on-time current-mode regulator, ultra-low  $R_{DS(ON)}$  FETs with fast switching speed and integrated Schottky diode. The typical switching frequency is 850kHz at full load. With current mode control and internal feedback loop compensation, the LTM4600 module has sufficient stability margins and good transient performance under a wide range of operating conditions and with a wide range of output capacitors, even all ceramic output capacitors (X5R or X7R).

Current mode control provides cycle-by-cycle fast current limit. In addition, foldback current limiting is provided in an over-current condition while  $V_{OSET}$  drops. Also, the LTM4600 has defeatable short circuit latch off. Internal overvoltage and undervoltage comparators pull the open-drain PGOOD output low if the output feedback voltage exits

a  $\pm 10\%$  window around the regulation point. Furthermore, in an overvoltage condition, internal top FET Q1 is turned off and bottom FET Q2 is turned on and held on until the overvoltage condition clears.

Pulling the RUN/SS pin low forces the controller into its shutdown state, turning off both Q1 and Q2. Releasing the pin allows an internal  $1.2\mu A$  current source to charge up the softstart capacitor. When this voltage reaches 1.5V, the controller turns on and begins switching.

At low load current the module works in continuous current mode by default to achieve minimum output voltage ripple. It can be programmed to operate in discontinuous current mode for improved light load efficiency when the FCB pin is pulled up above 0.8V and no higher than 6V. The FCB pin has a 4.75k resistor to ground, so a resistor to  $V_{IN}$  can set the voltage on the FCB pin.

When  $EXTV_{CC}$  pin is grounded or open, an integrated 5V linear regulator powers the controller and MOSFET gate drivers. If a minimum 4.7V external bias supply is applied on the  $EXTV_{CC}$  pin, the internal regulator is turned off, and an internal switch connects  $EXTV_{CC}$  to the gate driver voltage. This eliminates the linear regulator power loss with high input voltage, reducing the thermal stress on the controller. The maximum voltage on  $EXTV_{CC}$  pin is 6V. The  $EXTV_{CC}$  voltage should never be higher than the  $V_{IN}$  voltage. Also  $EXTV_{CC}$  must be sequenced after  $V_{IN}$ .



## APPLICATIONS INFORMATION

The typical LTM4600 application circuit is shown in Figure 18. External component selection is primarily determined by the maximum load current and output voltage.

### Output Voltage Programming and Margining

The PWM controller of the LTM4600 has an internal  $0.6V \pm 1\%$  reference voltage. As shown in the block diagram, a  $100k/0.5\%$  internal feedback resistor connects  $V_{OUT}$  and  $V_{OSET}$  pins. Adding a resistor  $R_{SET}$  from  $V_{OSET}$  pin to SGND pin programs the output voltage:

$$V_O = 0.6V \cdot \frac{100k + R_{SET}}{R_{SET}}$$

Table 1 shows the standard values of 1%  $R_{SET}$  resistor for typical output voltages:

Table 1.

$R_{SET}$ (k $\Omega$ )	Open	100	66.5	49.9	43.2	31.6	22.1	13.7
$V_O$ (V)	0.6	1.2	1.5	1.8	2	2.5	3.3	5

Voltage margining is the dynamic adjustment of the output voltage to its worst case operating range in production testing to stress the load circuitry, verify control/protection functionality of the board and improve the system reliability. Figure 2 shows how to implement margining function with the LTM4600. In addition to the feedback resistor  $R_{SET}$ , several external components are added. Turn off both transistor  $Q_{UP}$  and  $Q_{DOWN}$  to disable the margining. When  $Q_{UP}$  is on and  $Q_{DOWN}$  is off, the output voltage is margined up. The output voltage is margined



Figure 2. LTM4600 Margining Implementation

down when  $Q_{DOWN}$  is on and  $Q_{UP}$  is off. If the output voltage  $V_O$  needs to be margined up/down by  $\pm M\%$ , the resistor values of  $R_{UP}$  and  $R_{DOWN}$  can be calculated from the following equations:

$$\frac{(R_{SET} \parallel R_{UP}) \cdot V_O \cdot (1 + M\%)}{(R_{SET} \parallel R_{UP}) + 100k\Omega} = 0.6V$$

$$\frac{R_{SET} \cdot V_O \cdot (1 - M\%)}{R_{SET} + (100k\Omega \parallel R_{DOWN})} = 0.6V$$

### Input Capacitors

The LTM4600  $\mu$ Module should be connected to a low ac-impedance DC source. High frequency, low ESR input capacitors are required to be placed adjacent to the module. In Figure 18, the bulk input capacitor  $C_{IN}$  is selected for its ability to handle the large RMS current into the converter. For a buck converter, the switching duty-cycle can be estimated as:

$$D = \frac{V_O}{V_{IN}}$$

Without considering the inductor current ripple, the RMS current of the input capacitor can be estimated as:

$$I_{CIN(RMS)} = \frac{I_{O(MAX)}}{\eta\%} \cdot \sqrt{D \cdot (1 - D)}$$

In the above equation,  $\eta\%$  is the estimated efficiency of the power module.  $C_1$  can be a switcher-rated electrolytic aluminum capacitor, OS-CON capacitor or high volume ceramic capacitors. Note the capacitor ripple current ratings are often based on only 2000 hours of life. This makes it advisable to properly derate the input capacitor, or choose a capacitor rated at a higher temperature than required. Always contact the capacitor manufacturer for derating requirements.

In Figure 18, the input capacitors are used as high frequency input decoupling capacitors. In a typical 10A output application, 1-2 pieces of very low ESR X5R or X7R,  $10\mu F$  ceramic capacitors are recommended. This decoupling capacitor should be placed directly adjacent

## APPLICATIONS INFORMATION

the module input pins in the PCB layout to minimize the trace inductance and high frequency AC noise.

### Output Capacitors

The LTM4600 is designed for low output voltage ripple. The bulk output capacitors  $C_{OUT}$  is chosen with low enough effective series resistance (ESR) to meet the output voltage ripple and transient requirements.  $C_{OUT}$  can be low ESR tantalum capacitor, low ESR polymer capacitor or ceramic capacitor (X5R or X7R). The typical capacitance is 200 $\mu$ F if all ceramic output capacitors are used. The internally optimized loop compensation provides sufficient stability margin for all ceramic capacitors applications. Additional output filtering may be required by the system designer, if further reduction of output ripple or dynamic transient spike is required. Refer to Table 2 for an output capacitance matrix for each output voltage Droop, peak to peak deviation and recovery time during a 5A/ $\mu$ s transient with a specific output capacitance.

### Fault Conditions: Current Limit and Over current Foldback

The LTM4600 has a current mode controller, which inherently limits the cycle-by-cycle inductor current not only in steady state operation, but also in transient.

To further limit current in the event of an over load condition, the LTM4600 provides foldback current limiting. If the output voltage falls by more than 50%, then the maximum output current is progressively lowered to about one sixth of its full current limit value.

### Soft-Start and Latchoff with the RUN/SS pin

The RUN/SS pin provides a means to shut down the LTM4600 as well as a timer for soft-start and over-current latchoff. Pulling the RUN/SS pin below 0.8V puts the LTM4600 into a low quiescent current shutdown ( $I_Q \leq 75\mu$ A). Releasing the pin allows an internal 1.2 $\mu$ A current source to charge up the timing capacitor  $C_{SS}$ . Inside LTM4600, there is an internal 1000pF capacitor from RUN/SS pin to ground. If RUN/SS pin has an external capacitor  $C_{SS\_EXT}$  to ground, the delay before starting is about:

$$t_{DELAY} = \frac{1.5V}{1.2\mu A} \cdot (C_{SS\_EXT} + 1000pF)$$

When the voltage on RUN/SS pin reaches 1.5V, the LTM4600 internal switches are operating with a clamping of the maximum output inductor current limited by the RUN/SS pin total soft-start capacitance. As the RUN/SS pin voltage rises to 3V, the soft-start clamping of the inductor current is released.

### $V_{IN}$ to $V_{OUT}$ Step-Down Ratios

There are restrictions in the maximum  $V_{IN}$  to  $V_{OUT}$  step down ratio that can be achieved for a given input voltage. These constraints are shown in the Typical Performance Characteristics curves labeled " $V_{IN}$  to  $V_{OUT}$  Step-Down Ratio". Note that additional thermal derating may apply. See the Thermal Considerations and Output Current Derating sections of this data sheet.

After the controller has been started and given adequate

## APPLICATIONS INFORMATION

**Table 2. Output Voltage Response Versus Component Matrix (Refer to Figure 18)**

**TYPICAL MEASURED VALUES**

<b>C<sub>OUT1</sub> VENDORS</b>	<b>PART NUMBER</b>	<b>C<sub>OUT2</sub> VENDORS</b>	<b>PART NUMBER</b>
TDK	C4532X5R0J107MZ (100µF, 6.3V)	SANYO POSCAP	6TPE330MIL (330µF, 6.3V)
TAIYO YUDEN	JMK432BJ107MU-T (100µF, 6.3V)	SANYO POSCAP	2R5TPE470M9 (470µF, 2.5V)
TAIYO YUDEN	JMK316BJ226ML-T501 (22µF, 6.3V)	SANYO POSCAP	4TPE470MCL (470µF, 4V)

<b>V<sub>OUT</sub> (V)</b>	<b>C<sub>IN</sub> (CERAMIC)</b>	<b>C<sub>IN</sub> (BULK)</b>	<b>C<sub>OUT1</sub> (CERAMIC)</b>	<b>C<sub>OUT2</sub> (BULK)</b>	<b>C<sub>COMP</sub></b>	<b>C3</b>	<b>V<sub>IN</sub> (V)</b>	<b>DROOP (mV)</b>	<b>PEAK TO PEAK (mV)</b>	<b>RECOVERY TIME (µs)</b>	<b>LOAD STEP (A/µs)</b>
1.2	2 × 10µF 25V	150µF 35V	3 × 22µF 6.3V	470µF 4V	NONE	100pF	5	35	68	25	5
1.2	2 × 10µF 25V	150µF 35V	1 × 100µF 6.3V	470µF 2.5V	NONE	100pF	5	35	70	20	5
1.2	2 × 10µF 25V	150µF 35V	2 × 100µF 6.3V	330µF 6.3V	NONE	100pF	5	40	80	20	5
1.2	2 × 10µF 25V	150µF 35V	4 × 100µF 6.3V	NONE	NONE	100pF	5	49	98	20	5
1.2	2 × 10µF 25V	150µF 35V	3 × 22µF 6.3V	470µF 4V	NONE	100pF	12	35	68	25	5
1.2	2 × 10µF 25V	150µF 35V	1 × 100µF 6.3V	470µF 2.5V	NONE	100pF	12	35	70	20	5
1.2	2 × 10µF 25V	150µF 35V	2 × 100µF 6.3V	330µF 6.3V	NONE	100pF	12	40	80	20	5
1.2	2 × 10µF 25V	150µF 35V	4 × 100µF 6.3V	NONE	NONE	100pF	12	49	98	20	5
1.5	2 × 10µF 25V	150µF 35V	3 × 22µF 6.3V	470µF 4V	NONE	100pF	5	36	75	25	5
1.5	2 × 10µF 25V	150µF 35V	1 × 100µF 6.3V	470µF 2.5V	NONE	100pF	5	37	79	20	5
1.5	2 × 10µF 25V	150µF 35V	2 × 100µF 6.3V	330µF 6.3V	NONE	100pF	5	44	84	20	5
1.5	2 × 10µF 25V	150µF 35V	4 × 100µF 6.3V	NONE	NONE	100pF	5	61	118	20	5
1.5	2 × 10µF 25V	150µF 35V	3 × 22µF 6.3V	470µF 4V	NONE	100pF	12	36	75	25	5
1.5	2 × 10µF 25V	150µF 35V	1 × 100µF 6.3V	470µF 2.5V	NONE	100pF	12	37	79	20	5
1.5	2 × 10µF 25V	150µF 35V	2 × 100µF 6.3V	330µF 6.3V	NONE	100pF	12	44	89	20	5
1.5	2 × 10µF 25V	150µF 35V	4 × 100µF 6.3V	NONE	NONE	100pF	12	54	108	20	5
1.8	2 × 10µF 25V	150µF 35V	3 × 22µF 6.3V	470µF 4V	NONE	100pF	5	40	81	30	5
1.8	2 × 10µF 25V	150µF 35V	1 × 100µF 6.3V	470µF 2.5V	NONE	100pF	5	44	88	20	5
1.8	2 × 10µF 25V	150µF 35V	2 × 100µF 6.3V	330µF 6.3V	NONE	100pF	5	46	91	20	5
1.8	2 × 10µF 25V	150µF 35V	4 × 100µF 6.3V	NONE	NONE	100pF	5	62	128	20	5
1.8	2 × 10µF 25V	150µF 35V	3 × 22µF 6.3V	470µF 4V	NONE	100pF	12	40	81	30	5
1.8	2 × 10µF 25V	150µF 35V	1 × 100µF 6.3V	470µF 2.5V	NONE	100pF	12	44	85	20	5
1.8	2 × 10µF 25V	150µF 35V	2 × 100µF 6.3V	330µF 6.3V	NONE	100pF	12	44	91	20	5
1.8	2 × 10µF 25V	150µF 35V	4 × 100µF 6.3V	NONE	NONE	100pF	12	62	125	20	5
2.5	2 × 10µF 25V	150µF 35V	1 × 100µF 6.3V	470µF 4V	NONE	100pF	5	48	103	30	5
2.5	2 × 10µF 25V	150µF 35V	2 × 100µF 6.3V	330µF 6.3V	NONE	100pF	5	56	113	30	5
2.5	2 × 10µF 25V	150µF 35V	3 × 22µF 6.3V	470µF 4V	NONE	100pF	5	57	116	30	5
2.5	2 × 10µF 25V	150µF 35V	4 × 100µF 6.3V	NONE	NONE	100pF	5	60	115	25	5
2.5	2 × 10µF 25V	150µF 35V	1 × 100µF 6.3V	470µF 4V	NONE	100pF	12	48	103	30	5
2.5	2 × 10µF 25V	150µF 35V	3 × 22µF 6.3V	470µF 4V	NONE	100pF	12	51	102	30	5
2.5	2 × 10µF 25V	150µF 35V	2 × 100µF 6.3V	330µF 6.3V	NONE	100pF	12	56	113	30	5
2.5	2 × 10µF 25V	150µF 35V	4 × 100µF 6.3V	NONE	NONE	100pF	12	70	159	25	5
3.3	2 × 10µF 25V	150µF 35V	2 × 100µF 6.3V	330µF 6.3V	NONE	100pF	7	64	126	30	5
3.3	2 × 10µF 25V	150µF 35V	1 × 100µF 6.3V	470µF 4V	NONE	100pF	7	66	132	30	5
3.3	2 × 10µF 25V	150µF 35V	3 × 22µF 6.3V	470µF 4V	NONE	100pF	7	82	166	35	5
3.3	2 × 10µF 25V	150µF 35V	4 × 100µF 6.3V	NONE	NONE	100pF	7	100	200	25	5
3.3	2 × 10µF 25V	150µF 35V	1 × 100µF 6.3V	470µF 4V	NONE	100pF	12	52	106	30	5
3.3	2 × 10µF 25V	150µF 35V	3 × 22µF 6.3V	470µF 4V	NONE	100pF	12	64	129	35	5
3.3	2 × 10µF 25V	150µF 35V	2 × 100µF 6.3V	330µF 6.3V	NONE	100pF	12	64	126	30	5
3.3	2 × 10µF 25V	150µF 35V	4 × 100µF 6.3V	NONE	NONE	100pF	12	76	144	25	5
5	2 × 10µF 25V	150µF 35V	4 × 100µF 6.3V	NONE	NONE	100pF	15	188	375	25	5
5	2 × 10µF 25V	150µF 35V	4 × 100µF 6.3V	NONE	NONE	100pF	20	159	320	25	5

## APPLICATIONS INFORMATION

time to charge up the output capacitor,  $C_{SS}$  is used as a short-circuit timer. After the RUN/SS pin charges above 4V, if the output voltage falls below 75% of its regulated value, then a short-circuit fault is assumed. A 1.8 $\mu$ A current then begins discharging  $C_{SS}$ . If the fault condition persists until the RUN/SS pin drops to 3.5V, then the controller turns off both power MOSFETs, shutting down the converter permanently. The RUN/SS pin must be actively pulled down to ground in order to restart operation.

The over-current protection timer requires the soft-start timing capacitor  $C_{SS}$  be made large enough to guarantee that the output is in regulation by the time  $C_{SS}$  has reached the 4V threshold. In general, this will depend upon the size of the output capacitance, output voltage and load current characteristic. A minimum external soft-start capacitor can be estimated from:

$$C_{SS \text{ EXT}} + 1000\text{pF} > C_{\text{OUT}} \cdot V_{\text{OUT}} (10^{-3} [\text{F} / V_{\text{S}}])$$

Generally 0.1 $\mu$ F is more than sufficient.

Since the load current is already limited by the current mode control and current foldback circuitry during a shortcircuit, over-current latchoff operation is NOT always needed or desired, especially if the output has a large amount of capacitance or the load draws huge currents during start up. The latchoff feature can be overridden by a pull-up current greater than 5 $\mu$ A but less than 80 $\mu$ A to the RUN/SS pin. The additional currents prevents the discharge of  $C_{SS}$  during a fault and also shortens the soft-start period. Using a resistor from RUN/SS pin to  $V_{\text{IN}}$  is a simple solution to defeat latchoff. Any pull-up network must be able to maintain RUN/SS above 4V maximum latchoff threshold and overcome the 4 $\mu$ A maximum discharge current. Figure 3 shows a conceptual drawing of  $V_{\text{RUN}}$  during startup and short circuit.



Figure 3. RUN/SS Pin Voltage During Startup and Short-Circuit Protection



Figure 4. Defeat Short-Circuit Latchoff with a Pull-Up Resistor to  $V_{\text{IN}}$

### Enable

The RUN/SS pin can be driven from logic as shown in Figure 5. This function allows the LTM4600 to be turned on or off remotely. The  $\overline{\text{ON}}$  signal can also control the sequence of the output voltage.



Figure 5. Enable Circuit with External Logic

## APPLICATIONS INFORMATION

### Output Voltage Tracking

For the applications that require output voltage tracking, several LTM4600 modules can be programmed by the power supply tracking controller such as the LTC2923. Figure 6 shows a typical schematic with LTC2923. Coincident, ratiometric and offset tracking for  $V_O$  rising and falling can be implemented with different sets of resistor values. See the LTC2923 data sheet for more details.



Figure 6. Output Voltage Tracking with the LTC2923 Controller

### EXTV<sub>CC</sub> Connection

An internal low dropout regulator produces an internal 5V supply that powers the control circuitry and FET drivers. Therefore, if the system does not have a 5V power rail, the LTM4600 can be directly powered by  $V_{IN}$ . The gate driver current through LDO is about 18mA. The internal LDO power dissipation can be calculated as:

$$P_{LDO\_LOSS} = 18\text{mA} \cdot (V_{IN} - 5\text{V})$$

The LTM4600 also provides an external gate driver voltage pin  $EXTV_{CC}$ . If there is a 5V rail in the system, it is recommended to connect  $EXTV_{CC}$  pin to the external 5V rail. Whenever the  $EXTV_{CC}$  pin is above 4.7V, the internal 5V LDO is shut off and an internal 50mA P-channel switch connects the  $EXTV_{CC}$  to internal 5V. Internal 5V is supplied from  $EXTV_{CC}$  until this pin drops below 4.5V. Do not apply more than 6V to the  $EXTV_{CC}$  pin and ensure that  $EXTV_{CC} < V_{IN}$ . The following list summarizes the possible connections for  $EXTV_{CC}$ :

1.  $EXTV_{CC}$  grounded. Internal 5V LDO is always powered from the internal 5V regulator.
2.  $EXTV_{CC}$  connected to an external supply. Internal LDO is shut off. A high efficiency supply compatible with the MOSFET gate drive requirements (typically 5V) can improve overall efficiency. With this connection, it is always required that the  $EXTV_{CC}$  voltage can not be higher than  $V_{IN}$  pin voltage.

### Discontinuous Operation and FCB Pin

The FCB pin determines whether the internal bottom MOSFET remains on when the inductor current reverses. There is an internal 4.75k pull-down resistor connecting this pin to ground. The default light load operation mode is forced continuous (PWM) current mode. This mode provides minimum output voltage ripple.

In the application where the light load efficiency is important, tying the FCB pin above 0.6V threshold enables discontinuous operation where the bottom MOSFET turns off when inductor current reverses. Therefore, the conduction loss is minimized and light load efficiency is improved. The penalty is that the controller may skip cycle and the output voltage ripple increases at light load.

### Paralleling Operation with Load Sharing

Two or more LTM4600 modules can be paralleled to provide higher than 10A output current. Figure 7 shows the necessary interconnection between two paralleled modules. The OPTI-LOOP® current mode control ensures good current sharing among modules to balance the thermal stress. The new feedback equation for two or more LTM4600s in parallel is:

$$V_{OUT} = 0.6\text{V} \cdot \frac{\frac{100\text{k}}{N} + R_{SET}}{R_{SET}}$$

where N is the number of LTM4600s in parallel.

OPTI-LOOP is a registered trademark of Linear Technology Corporation.

## APPLICATIONS INFORMATION



Figure 7. Parallel Two  $\mu$ Modules with Load Sharing

### Thermal Considerations and Output Current Derating

The power loss curves in Figures 8 and 13 can be used in coordination with the load current derating curves in Figures 9 to 12, and Figures 14 to 15 for calculating an approximate  $\theta_{JA}$  for the module with various heatsinking methods. Thermal models are derived from several

temperature measurements at the bench, and thermal modeling analysis. Application Note 103 provides a detailed explanation of the analysis for the thermal models, and the derating curves. Tables 3 and 4 provide a summary of the equivalent  $\theta_{JA}$  for the noted conditions. These equivalent  $\theta_{JA}$  parameters are correlated to the measured values, and improve with air-flow. The case temperature is maintained at 100°C or below for the derating curves. This allows for 4W maximum power dissipation in the total module with top and bottom heatsinking, and 2W power dissipation through the top of the module with an approximate  $\theta_{JC}$  between 6°C/W to 9°C/W. This equates to a total of 124°C at the junction of the device.

### Safety Considerations

The LTM4600 modules do not provide isolation from  $V_{IN}$  to  $V_{OUT}$ . There is no internal fuse. If required, a slow blow fuse with a rating twice the maximum input current should be provided to protect each unit from catastrophic failure.

Table 3. 1.5V Output

DERATING CURVE	$V_{IN}$ (V)	POWER LOSS CURVE	AIR FLOW (LFM)	HEATSINK	$\theta_{JA}$ (°C/W)
Figures 9, 11	5, 12	Figure 8	0	None	15.2
Figures 9, 11	5, 12	Figure 8	200	None	14
Figures 9, 11	5, 12	Figure 8	400	None	12
Figures 10, 12	5, 12	Figure 8	0	BGA Heatsink	13.9
Figures 10, 12	5, 12	Figure 8	200	BGA Heatsink	11.3
Figures 10, 12	5, 12	Figure 8	400	BGA Heatsink	10.25

Table 4. 3.3V Output

DERATING CURVE	$V_{IN}$ (V)	POWER LOSS CURVE	AIR FLOW (LFM)	HEATSINK	$\theta_{JA}$ (°C/W)
Figure 14	12	Figure 13	0	None	15.2
Figure 14	12	Figure 13	200	None	14.6
Figure 14	12	Figure 13	400	None	13.4
Figure 15	12	Figure 13	0	BGA Heatsink	13.9
Figure 15	12	Figure 13	200	BGA Heatsink	11.1
Figure 15	12	Figure 13	400	BGA Heatsink	10.5

# APPLICATIONS INFORMATION



Figure 8. Power Loss vs Load Current



Figure 9. No Heatsink

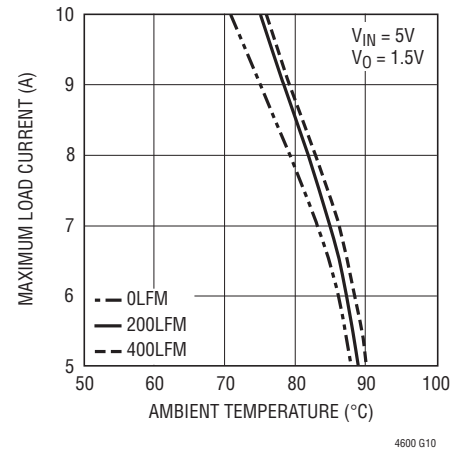

Figure 10. BGA Heatsink



Figure 11. No Heatsink



Figure 12. BGA Heatsink

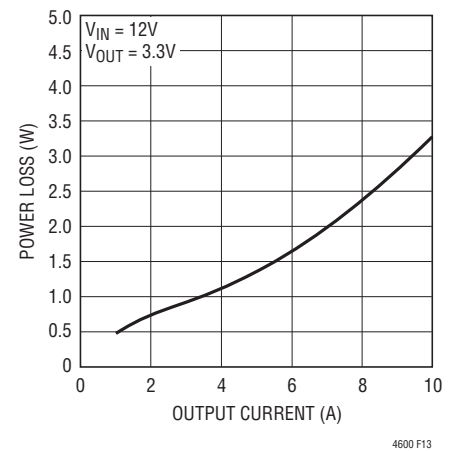

Figure 13. Power Loss vs Load Current



Figure 14. No Heatsink



Figure 15. BGA Heatsink

## APPLICATIONS INFORMATION

### Layout Checklist/Example

The high integration of the LTM4600 makes the PCB board layout very simple and easy. However, to optimize its electrical and thermal performance, some layout considerations are still necessary.

- Use large PCB copper areas for high current path, including  $V_{IN}$ , PGND and  $V_{OUT}$ . It helps to minimize the PCB conduction loss and thermal stress
- Place high frequency ceramic input and output capacitors next to the  $V_{IN}$ , PGND and  $V_{OUT}$  pins to minimize high frequency noise
- Place a dedicated power ground layer underneath the unit
- To minimize the via conduction loss and reduce module thermal stress, use multiple vias for interconnection between top layer and other power layers
- Do not put a via directly on pad unless it is capped
- Use a separated SGND ground copper area for components connected to signal pins. Connect the SGND to PGND underneath the unit

Figure 16 gives a good example of the recommended layout.

### LTM4600 Frequency Adjustment

The LTM4600 is designed to typically operate at 850kHz across most input and output conditions. The control architecture is constant on time valley mode current control. The  $f_{ADJ}$  pin is typically left open or decoupled with an optional 1000pF capacitor. The switching frequency has been optimized to maintain constant output ripple over the operating conditions. The equations for setting the operating frequency are set around a programmable constant on time. This on time is developed by a programmable current into an on board 10pF capacitor that establishes a ramp that is compared to a voltage threshold equal to the output voltage up to a 2.4V clamp. This  $I_{ON}$  current is equal to:  $I_{ON} = (V_{IN} - 0.7V)/110k$ , with the 110k onboard resistor from  $V_{IN}$  to  $f_{ADJ}$ . The on time is equal to  $t_{ON} = (V_{OUT}/I_{ON}) \cdot 10pF$  and  $t_{OFF} = t_s - t_{ON}$ . The frequency is equal to:  $Freq. = DC/t_{ON}$ . The  $I_{ON}$  current is proportional to  $V_{IN}$ , and the regulator duty cycle is inversely proportional to  $V_{IN}$ , therefore the step-down regulator will remain relatively constant frequency as the duty cycle adjustment takes place with lowering  $V_{IN}$ . The on time is proportional to  $V_{OUT}$  up to a 2.4V clamp. This will hold frequency relatively constant with different output voltages up to 2.4V. The regulator switching period is comprised of the on time and off time as depicted in Figure 17.



Figure 16. Recommended PCB Layout



## APPLICATIONS INFORMATION

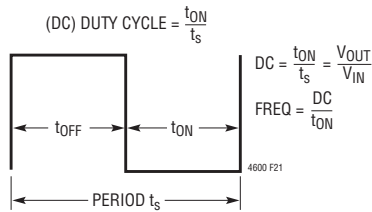

Figure 17. LTM4600 Switching Period

The LTM4600 has a minimum ( $t_{ON}$ ) on time of 100 nanoseconds and a minimum ( $t_{OFF}$ ) off time of 400 nanoseconds. The 2.4V clamp on the ramp threshold as a function of  $V_{OUT}$  will cause the switching frequency to increase by the ratio of  $V_{OUT}/2.4V$  for 3.3V and 5V outputs. This is due to the fact the on time will not increase as  $V_{OUT}$  increases past 2.4V. Therefore, if the nominal switching frequency is 850kHz, then the switching frequency will increase to ~1.2MHz for 3.3V, and ~1.7MHz for 5V outputs due to Frequency =  $(DC/t_{ON})$ . When the switching frequency increases to 1.2MHz, then the time period  $t_s$  is reduced to ~833 nanoseconds and at 1.7MHz the switching period reduces to ~588 nanoseconds. When higher duty cycle conversions like 5V to 3.3V and 12V to 5V need to be accommodated, then the switching frequency can be lowered to alleviate the violation of the 400ns minimum off time. Since the total switching period is  $t_s = t_{ON} + t_{OFF}$ ,  $t_{OFF}$  will be below the 400ns minimum off time. A resistor from the  $f_{ADJ}$  pin to ground can shunt current away from the on time generator, thus allowing for a longer on time and a lower switching frequency. 12V to 5V and 5V to 3.3V derivations are explained in the data sheet to lower switching frequency and accommodate these step-down conversions.

Equations for setting frequency for 12V to 5V:

$$I_{ON} = (V_{IN} - 0.7V)/110k; I_{ON} = 103\mu A$$

$$\text{frequency} = (I_{ON}/[2.4V \cdot 10pF]) \cdot DC = 1.79\text{MHz};$$

DC = duty cycle, duty cycle is  $(V_{OUT}/V_{IN})$

$$t_s = t_{ON} + t_{OFF}; t_{ON} = \text{on-time}, t_{OFF} = \text{off-time of the switching period}; t_s = 1/\text{frequency}$$

$t_{OFF}$  must be greater than 400ns, or  $t_s - t_{ON} > 400\text{ns}$ .

$$t_{ON} = DC \cdot t_s$$

1MHz frequency or 1 $\mu$ s period is chosen for 12V to 5V.

$$t_{ON} = 0.41 \cdot 1\mu s \approx 410\text{ns}$$

$$t_{OFF} = 1\mu s - 410\text{ns} \approx 590\text{ns}$$

$t_{ON}$  and  $t_{OFF}$  are above the minimums with adequate guard band.

Using the frequency =  $(I_{ON}/[2.4V \cdot 10pF]) \cdot DC$ , solve for  $I_{ON} = (1\text{MHz} \cdot 2.4V \cdot 10pF) \cdot (1/0.41) \approx 58\mu A$ .  $I_{ON}$  current calculated from 12V input was 103 $\mu A$ , so a resistor from  $f_{ADJ}$  to ground =  $(0.7V/15k) = 46\mu A$ .  $103\mu A - 46\mu A = 57\mu A$ , sets the adequate  $I_{ON}$  current for proper frequency range for the higher duty cycle conversion of 12V to 5V. Input voltage range is limited to 9V to 16V. Higher input voltages can be used without the 15k on  $f_{ADJ}$ . The inductor ripple current gets too high above 16V, and the 400ns minimum off-time is limited below 9V.

Equations for setting frequency for 5V to 3.3V:

$$I_{ON} = (V_{IN} - 0.7V)/110k; I_{ON} = 39\mu A$$

$$\text{frequency} = (I_{ON}/[2.4V \cdot 10pF]) \cdot DC = 1.07\text{MHz};$$

DC = duty cycle, duty cycle is  $(V_{OUT}/V_{IN})$

$$t_s = t_{ON} + t_{OFF}; t_{ON} = DC \cdot t_s, t_{OFF} = \text{off-time of the switching period}; t_s = 1/\text{frequency}$$

$t_{OFF}$  must be greater than 400ns, or  $t_s - t_{ON} > 400\text{ns}$ .

The ~450kHz frequency or 2.22 $\mu$ s period is chosen for 5V to 3.3V. Frequency range is about 450kHz to 650kHz from 4.5V to 7V input.

$$t_{ON} = 0.66 \cdot 2.22\mu s \approx 1.46\mu s$$

$$t_{OFF} = 2.22\mu s - 1.46\mu s \approx 760\text{ns}$$

$t_{ON}$  and  $t_{OFF}$  are above the minimums with adequate guard band.

Using the frequency =  $(I_{ON}/[2.4V \cdot 10pF]) \cdot DC$ , solve for  $I_{ON} = (450\text{kHz} \cdot 2.4V \cdot 10pF) \cdot (1/0.66) \approx 16\mu A$ .  $I_{ON}$  current calculated from 5V input was 39 $\mu A$ , so a resistor from  $f_{ADJ}$  to ground =  $(0.7V/30.1k) = 23\mu A$ .  $39\mu A - 23\mu A = 16\mu A$ , sets the adequate  $I_{ON}$  current for proper frequency range for the higher duty cycle conversion of 5V to 3.3V. Input voltage range is limited to 4.5V to 7V. Higher input voltages can be used without the 30.1k on  $f_{ADJ}$ . The inductor ripple current gets too high above 7V, and the 400ns minimum off-time is limited below 4.5V.

## APPLICATIONS INFORMATION

### 5V to 3.3V at 8A



### 12V to 5V at 8A



### $V_{IN}$ to $V_{OUT}$ Step-Down Ratio for 12V<sub>IN</sub> to 5V<sub>OUT</sub> and 5V<sub>IN</sub> to 3.3V<sub>OUT</sub>



4600 F20

4600fc

**TYPICAL APPLICATION**

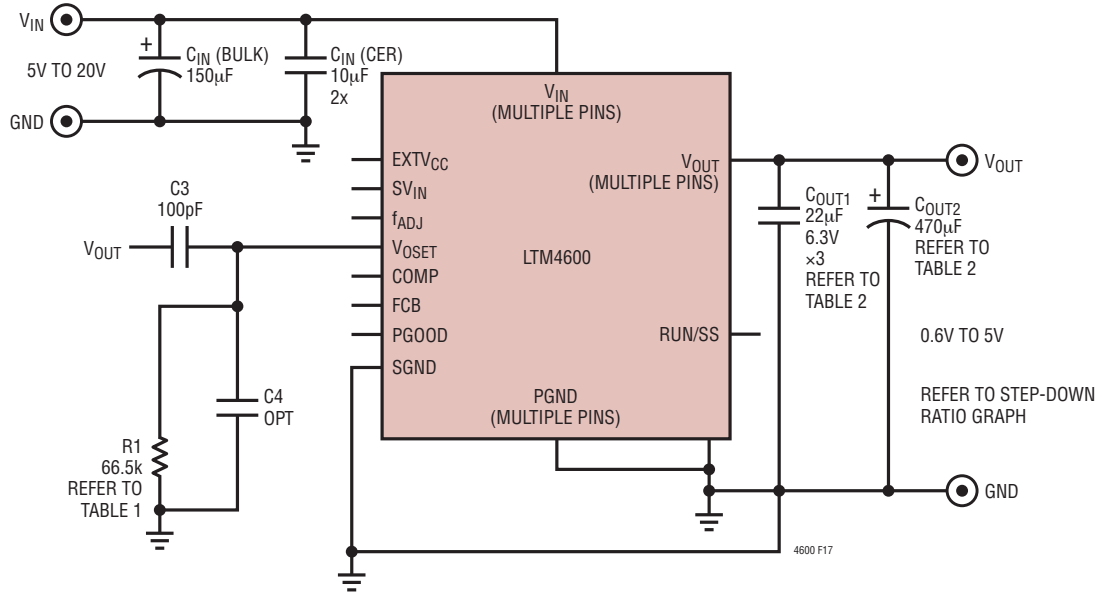

**Figure 18. Typical Application, 5V to 20V Input, 0.6V to 5V Output, 10A Max**

## TYPICAL APPLICATION

### Parallel Operation and Load Sharing



### Current Sharing Between Two LTM4600 Modules



4600 TA03

# PACKAGE DESCRIPTION

**LGA Package**  
**104-Lead (15mm × 15mm)**  
 (Reference LTM DWG # 05-05-1800)



- NOTES:
1. DIMENSIONING AND TOLERANCING PER ASME Y14.5M-1994
  2. ALL DIMENSIONS ARE IN MILLIMETERS
  3. LAND DESIGNATION PER JEDEC MO-222, SPP-010
  4. DETAILS OF PAD #1 IDENTIFIER ARE OPTIONAL, BUT MUST BE LOCATED WITHIN THE ZONE INDICATED. THE PAD #1 IDENTIFIER IS A MARKED FEATURE OR A NOTCHED BEVELED PAD
  5. PRIMARY DATUM - Z - IS SEATING PLANE
  6. THE TOTAL NUMBER OF PADS: 104

SYMBOL	TOLERANCE
aaa	0.15
bbb	0.10
eee	0.15



## PACKAGE DESCRIPTION

Pin Assignment Tables  
(Arranged by Pin Number)

PIN NAME	PIN NAME	PIN NAME	PIN NAME	PIN NAME	PIN NAME	PIN NAME	PIN NAME
A1 -	B1 $V_{IN}$	C1 -	D1 $V_{IN}$	E1 -	F1 $V_{IN}$	G1 PGND	H1 -
A2 -	B2 -	C2 -	D2 -	E2 -	F2 -	G2 -	H2 -
A3 $V_{IN}$	B3 -	C3 -	D3 -	E3 -	F3 -	G3 -	H3 -
A4 -	B4 -	C4 -	D4 -	E4 -	F4 -	G4 -	H4 -
A5 $V_{IN}$	B5 -	C5 -	D5 -	E5 -	F5 -	G5 -	H5 -
A6 -	B6 -	C6 -	D6 -	E6 -	F6 -	G6 -	H6 -
A7 $V_{IN}$	B7 -	C7 -	D7 -	E7 -	F7 -	G7 -	H7 PGND
A8 -	B8 -	C8 -	D8 -	E8 -	F8 -	G8 -	H8 -
A9 $V_{IN}$	B9 -	C9 -	D9 -	E9 -	F9 -	G9 -	H9 PGND
A10 -	B10 -	C10 $V_{IN}$	D10 -	E10 $V_{IN}$	F10 -	G10 -	H10 -
A11 $V_{IN}$	B11 -	C11 -	D11 -	E11 -	F11 -	G11 -	H11 PGND
A12 -	B12 -	C12 $V_{IN}$	D12 -	E12 $V_{IN}$	F12 -	G12 -	H12 -
A13 $V_{IN}$	B13 -	C13 -	D13 -	E13 -	F13 -	G13 -	H13 PGND
A14 -	B14 -	C14 $V_{IN}$	D14 -	E14 $V_{IN}$	F14 -	G14 -	H14 -
A15 $f_{ADJ}$	B15 -	C15 -	D15 -	E15 -	F15 -	G15 -	H15 PGND
A16 -	B16 -	C16 -	D16 -	E16 -	F16 -	G16 -	H16 -
A17 $SV_{IN}$	B17 -	C17 -	D17 -	E17 -	F17 -	G17 -	H17 PGND
A18 -	B18 -	C18 -	D18 -	E18 -	F18 -	G18 -	H18 -
A19 $EXTV_{CC}$	B19 -	C19 -	D19 -	E19 -	F19 -	G19 -	H19 -
A20 -	B20 -	C20 -	D20 -	E20 -	F20 -	G20 -	H20 -
A21 $V_{OSET}$	B21 -	C21 -	D21 -	E21 -	F21 -	G21 -	H21 -
A22 -	B22 -	C22 -	D22 -	E22 -	F22 -	G22 -	H22 -
A23 -	B23 COMP	C23 -	D23 SGND	E23 -	F23 RUN/SS	G23 FCB	H23 -

PIN NAME	PIN NAME	PIN NAME	PIN NAME	PIN NAME	PIN NAME	PIN NAME	PIN NAME
J1 PGND	K1 -	L1 -	M1 -	N1 -	P1 -	R1 -	T1 -
J2 -	K2 -	L2 PGND	M2 PGND	N2 PGND	P2 $V_{OUT}$	R2 $V_{OUT}$	T2 $V_{OUT}$
J3 -	K3 -	L3 -	M3 -	N3 -	P3 -	R3 -	T3 -
J4 -	K4 -	L4 PGND	M4 PGND	N4 PGND	P4 $V_{OUT}$	R4 $V_{OUT}$	T4 $V_{OUT}$
J5 -	K5 -	L5 -	M5 -	N5 -	P5 -	R5 -	T5 -
J6 -	K6 -	L6 PGND	M6 PGND	N6 PGND	P6 $V_{OUT}$	R6 $V_{OUT}$	T6 $V_{OUT}$
J7 -	K7 PGND	L7 -	M7 -	N7 -	P7 -	R7 -	T7 -
J8 -	K8 -	L8 PGND	M8 PGND	N8 PGND	P8 $V_{OUT}$	R8 $V_{OUT}$	T8 $V_{OUT}$
J9 -	K9 PGND	L9 -	M9 -	N9 -	P9 -	R9 -	T9 -
J10 -	K10 -	L10 PGND	M10 PGND	N10 PGND	P10 $V_{OUT}$	R10 $V_{OUT}$	T10 $V_{OUT}$
J11 -	K11 PGND	L11 -	M11 -	N11 -	P11 -	R11 -	T11 -
J12 -	K12 -	L12 PGND	M12 PGND	N12 PGND	P12 $V_{OUT}$	R12 $V_{OUT}$	T12 $V_{OUT}$
J13 -	K13 PGND	L13 -	M13 -	N13 -	P13 -	R13 -	T13 -
J14 -	K14 -	L14 PGND	M14 PGND	N14 PGND	P14 $V_{OUT}$	R14 $V_{OUT}$	T14 $V_{OUT}$
J15 -	K15 PGND	L15 -	M15 -	N15 -	P15 -	R15 -	T15 -
J16 -	K16 -	L16 PGND	M16 PGND	N16 PGND	P16 $V_{OUT}$	R16 $V_{OUT}$	T16 $V_{OUT}$
J17 -	K17 PGND	L17 -	M17 -	N17 -	P17 -	R17 -	T17 -
J18 -	K18 -	L18 PGND	M18 PGND	N18 PGND	P18 $V_{OUT}$	R18 $V_{OUT}$	T18 $V_{OUT}$
J19 -	K19 -	L19 -	M19 -	N19 -	P19 -	R19 -	T19 -
J20 -	K20 -	L20 PGND	M20 PGND	N20 PGND	P20 $V_{OUT}$	R20 $V_{OUT}$	T20 $V_{OUT}$
J21 -	K21 -	L21 -	M21 -	N21 -	P21 -	R21 -	T21 -
J22 -	K22 -	L22 PGND	M22 PGND	N22 PGND	P22 $V_{OUT}$	R22 $V_{OUT}$	T22 $V_{OUT}$
J23 PGOOD	K23 -	L23 -	M23 -	N23 -	P23 -	R23 -	T23 -

## PACKAGE DESCRIPTION

Pin Assignment Tables  
(Arranged by Pin Number)

PIN NAME		PIN NAME		PIN NAME		PIN NAME	
G1	PGND	P2	V <sub>OUT</sub>	A3	V <sub>IN</sub>	A15	f <sub>ADJ</sub>
H7	PGND	P4	V <sub>OUT</sub>	A5	V <sub>IN</sub>	A17	SV <sub>IN</sub>
H9	PGND	P6	V <sub>OUT</sub>	A7	V <sub>IN</sub>	A19	EXTV <sub>CC</sub>
H11	PGND	P8	V <sub>OUT</sub>	A9	V <sub>IN</sub>	A21	V <sub>OSET</sub>
H13	PGND	P10	V <sub>OUT</sub>	A11	V <sub>IN</sub>	B23	COMP
H15	PGND	P12	V <sub>OUT</sub>	A13	V <sub>IN</sub>	D23	SGND
H17	PGND	P14	V <sub>OUT</sub>	B1	V <sub>IN</sub>	F23	RUN/SS
J1	PGND	P16	V <sub>OUT</sub>	C10	V <sub>IN</sub>	G23	FCB
K7	PGND	P18	V <sub>OUT</sub>	C12	V <sub>IN</sub>	J23	PGOOD
K9	PGND	P20	V <sub>OUT</sub>	C14	V <sub>IN</sub>		
K11	PGND	P22	V <sub>OUT</sub>	D1	V <sub>IN</sub>		
K13	PGND	R2	V <sub>OUT</sub>	E10	V <sub>IN</sub>		
K15	PGND	R4	V <sub>OUT</sub>	E12	V <sub>IN</sub>		
K17	PGND	R6	V <sub>OUT</sub>	E14	V <sub>IN</sub>		
L2	PGND	R8	V <sub>OUT</sub>	F1	V <sub>IN</sub>		
L4	PGND	R10	V <sub>OUT</sub>				
L6	PGND	R12	V <sub>OUT</sub>				
L8	PGND	R14	V <sub>OUT</sub>				
L10	PGND	R16	V <sub>OUT</sub>				
L12	PGND	R18	V <sub>OUT</sub>				
L14	PGND	R20	V <sub>OUT</sub>				
L16	PGND	R22	V <sub>OUT</sub>				
L18	PGND	T2	V <sub>OUT</sub>				
L20	PGND	T4	V <sub>OUT</sub>				
L22	PGND	T6	V <sub>OUT</sub>				
M2	PGND	T8	V <sub>OUT</sub>				
M4	PGND	T10	V <sub>OUT</sub>				
M6	PGND	T12	V <sub>OUT</sub>				
M8	PGND	T14	V <sub>OUT</sub>				
M10	PGND	T16	V <sub>OUT</sub>				
M12	PGND	T18	V <sub>OUT</sub>				
M14	PGND	T20	V <sub>OUT</sub>				
M16	PGND	T22	V <sub>OUT</sub>				
M18	PGND						
M20	PGND						
M22	PGND						
N2	PGND						
N4	PGND						
N6	PGND						
N8	PGND						
N10	PGND						
N12	PGND						
N14	PGND						
N16	PGND						
N18	PGND						
N20	PGND						
N22	PGND						

## TYPICAL APPLICATION

### 1.8V, 10A Regulator



## RELATED PARTS

PART NUMBER	DESCRIPTION	COMMENTS
LTC2900	Quad Supply Monitor with Adjustable Reset Timer	Monitors Four Supplies; Adjustable Reset Timer
LTC2923	Power Supply Tracking Controller	Tracks Both Up and Down; Power Supply Sequencing
LT3825/LT3837	Synchronous Isolated Flyback Controllers	No Optocoupler Required; 3.3V, 12A Output; Simple Design
LTM4601	12A DC/DC $\mu$ Module with PLL, Output Tracking/Margining and Remote Sensing	Synchronizable, PolyPhase Operation, LTM4601-1 Version has no Remote Sensing
LTM4602	6A DC/DC $\mu$ Module	Pin Compatible with the LTM4600
LTM4603	6A DC/DC $\mu$ Module with PLL and Output Tracking/Margining and Remote Sensing	Synchronizable, PolyPhase Operation, LTM4603-1 Version has no Remote Sensing, Pin Compatible with the LTM4601

This product contains technology licensed from Silicon Semiconductor Corporation. Silicon Semiconductor® 4600fc





## Стандарт Электрон Связь

Мы молодая и активно развивающаяся компания в области поставок электронных компонентов. Мы поставляем электронные компоненты отечественного и импортного производства напрямую от производителей и с крупнейших складов мира.

Благодаря сотрудничеству с мировыми поставщиками мы осуществляем комплексные и плановые поставки широчайшего спектра электронных компонентов.

Собственная эффективная логистика и склад в обеспечивает надежную поставку продукции в точно указанные сроки по всей России.

Мы осуществляем техническую поддержку нашим клиентам и предпродажную проверку качества продукции. На все поставляемые продукты мы предоставляем гарантию .

Осуществляем поставки продукции под контролем ВП МО РФ на предприятия военно-промышленного комплекса России , а также работаем в рамках 275 ФЗ с открытием отдельных счетов в уполномоченном банке. Система менеджмента качества компании соответствует требованиям ГОСТ ISO 9001.

Минимальные сроки поставки, гибкие цены, неограниченный ассортимент и индивидуальный подход к клиентам являются основой для выстраивания долгосрочного и эффективного сотрудничества с предприятиями радиоэлектронной промышленности, предприятиями ВПК и научно-исследовательскими институтами России.

С нами вы становитесь еще успешнее!

### Наши контакты:

**Телефон:** +7 812 627 14 35

**Электронная почта:** [sales@st-electron.ru](mailto:sales@st-electron.ru)

**Адрес:** 198099, Санкт-Петербург,  
Промышленная ул, дом № 19, литера Н,  
помещение 100-Н Офис 331