

## SERIES 87 Low Profile

### FEATURES

- 1, 2, 3, 4, 5 and 6 Button Individual Keyswitches
- 12 and 16 Button Keypads
- Maintain 1/2" Button Centers, no Matter How You Mount Modules or What Combination You Use
- Up to 3,000,000 Operations per Button
- Low Profile Design

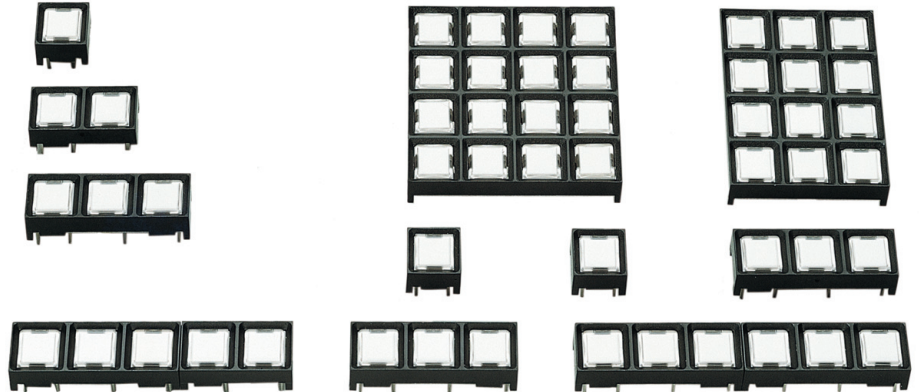

### Legends For Any Need

Design Keyboards and Individual Keyswitches to Virtually any Configuration Without Costly Tooling.

**Prototypes and small quantities:** create your own with economical, insertable legend style modules.

**Production quantities:** choose either custom printing or permanent molded-in legends.

### Snap Dome Contact System Hear and feel button actuation

You're assured of reliable button actuation with the metal snap-dome under each Series 87 button. When actuated, the dome changes shape, providing audible and tactile feedback to the operator.

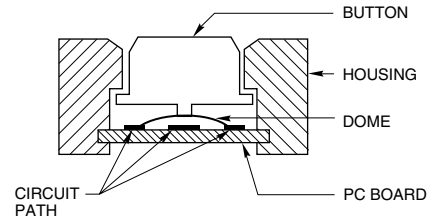

### DIMENSIONS in inches (and millimeters)

#### One Button Module

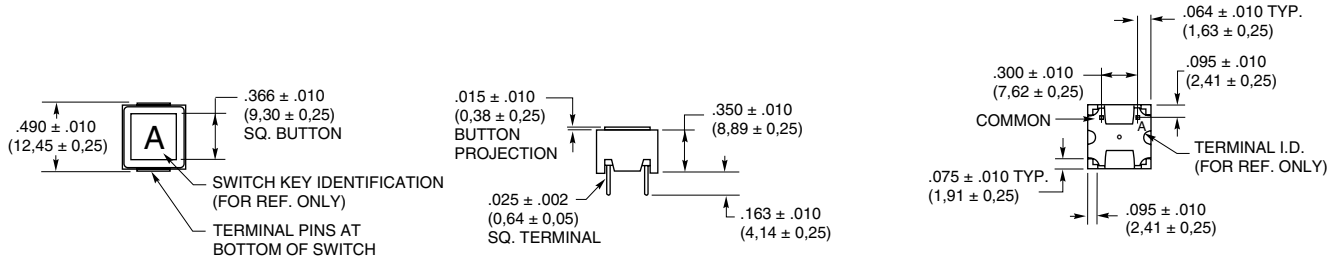

#### Two Button Module

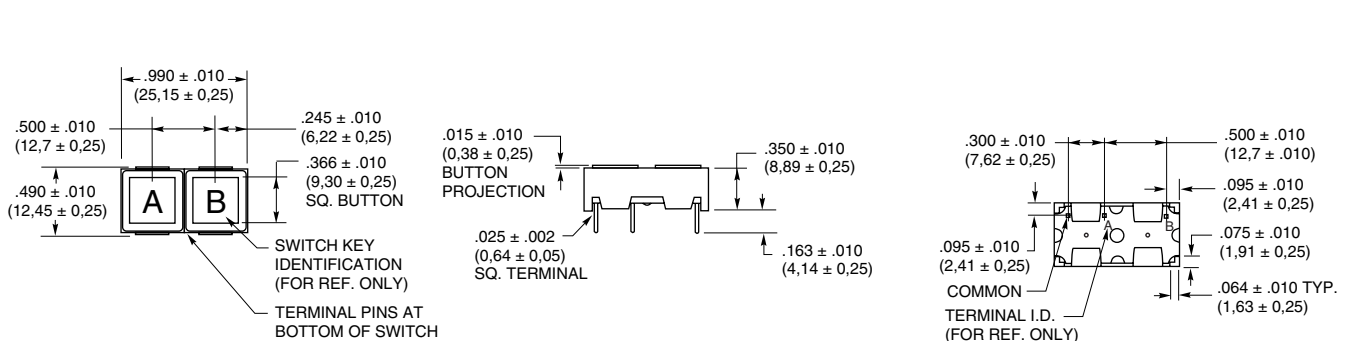

DIMENSIONS in inches (and millimeters)

Three Button Module

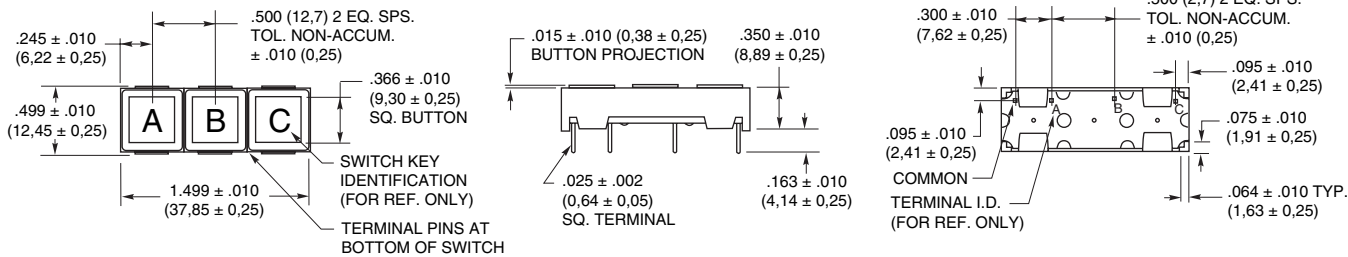

Four Button Module

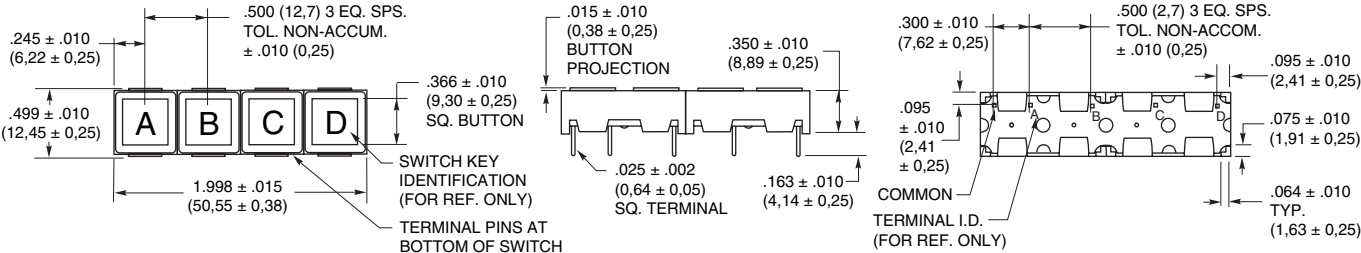

Five Button Module

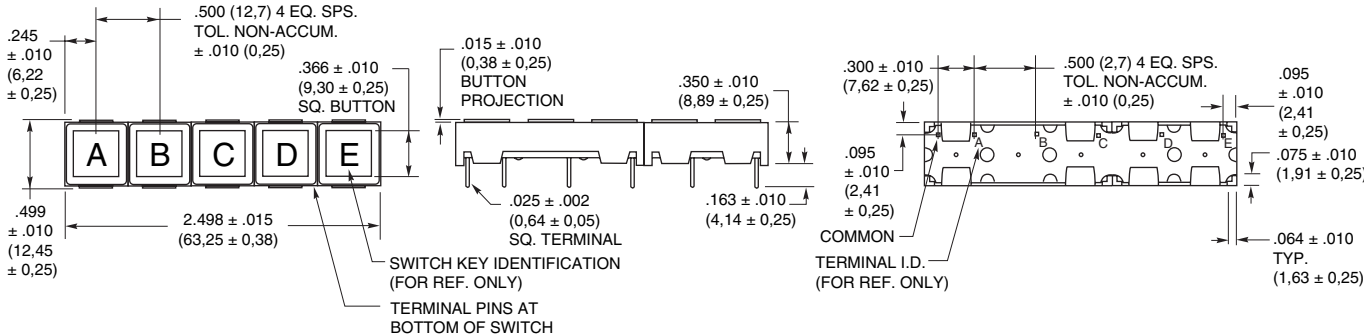

Six Button Module

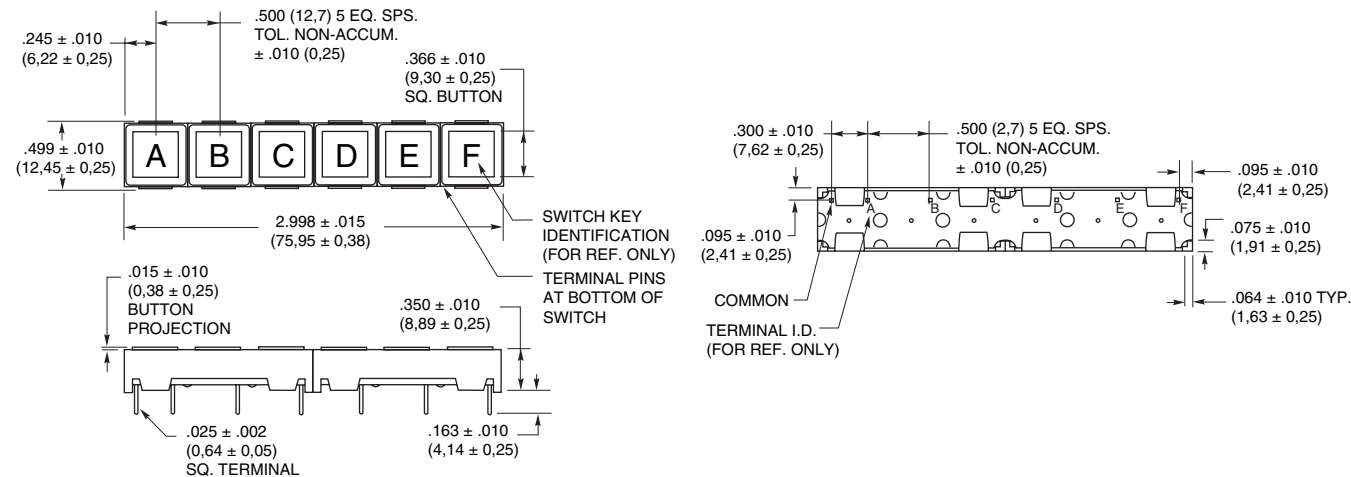

Keyboards and Keypads

**DIMENSIONS** in inches (and millimeters)

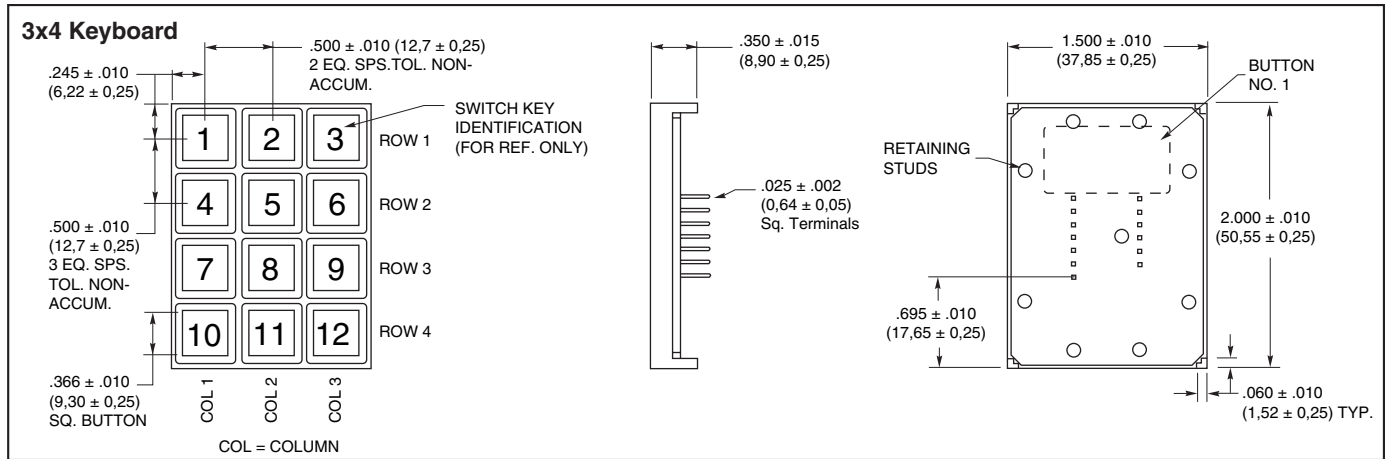

**Termination** in inches (and millimeters)

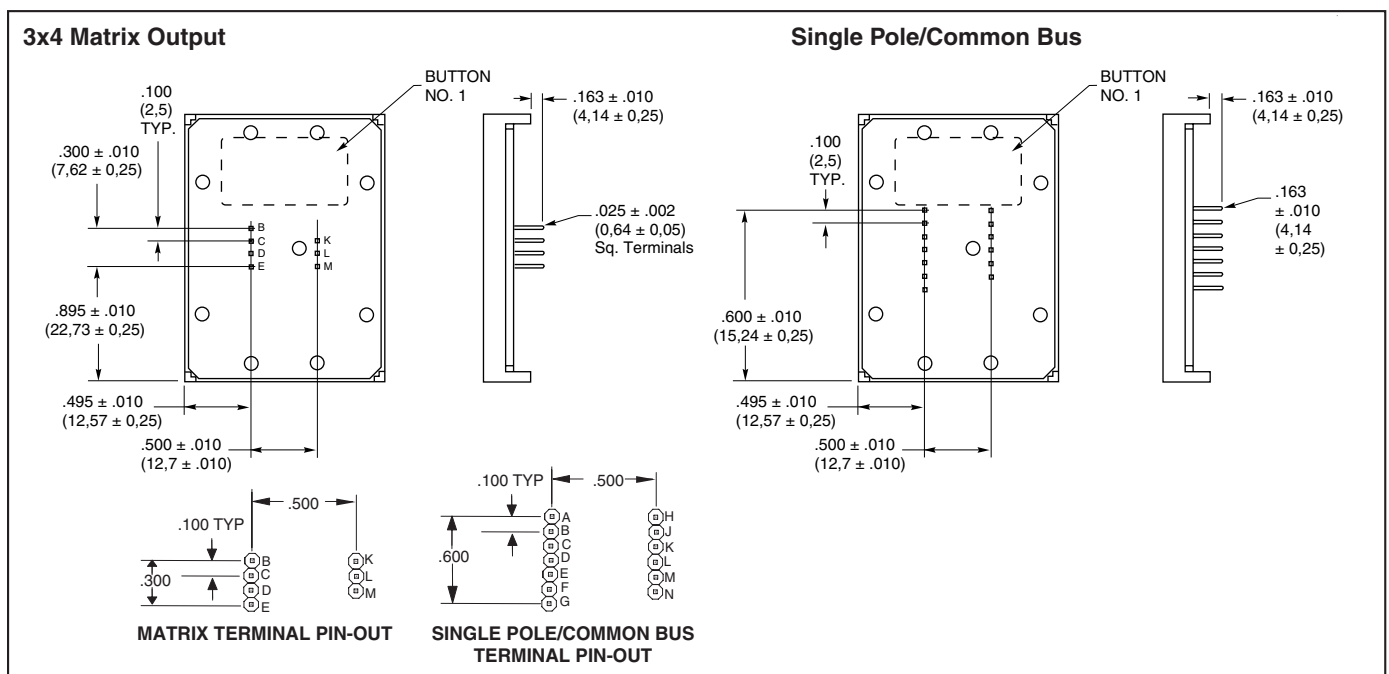

**DIMENSIONS** in inches (and millimeters)

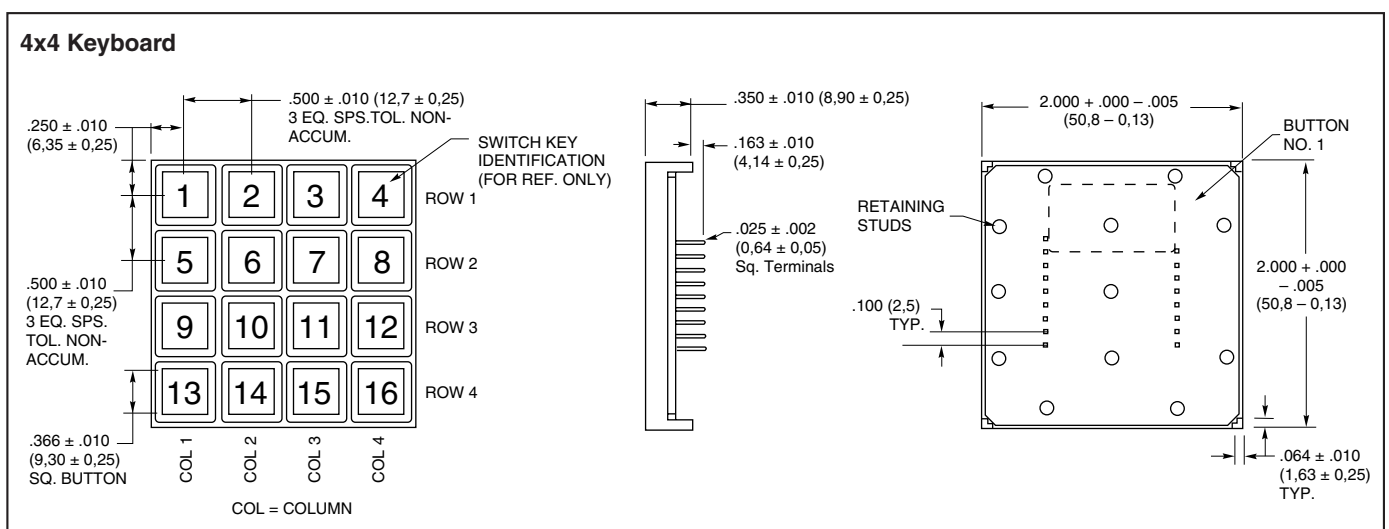

**Termination** in inches (and millimeters)

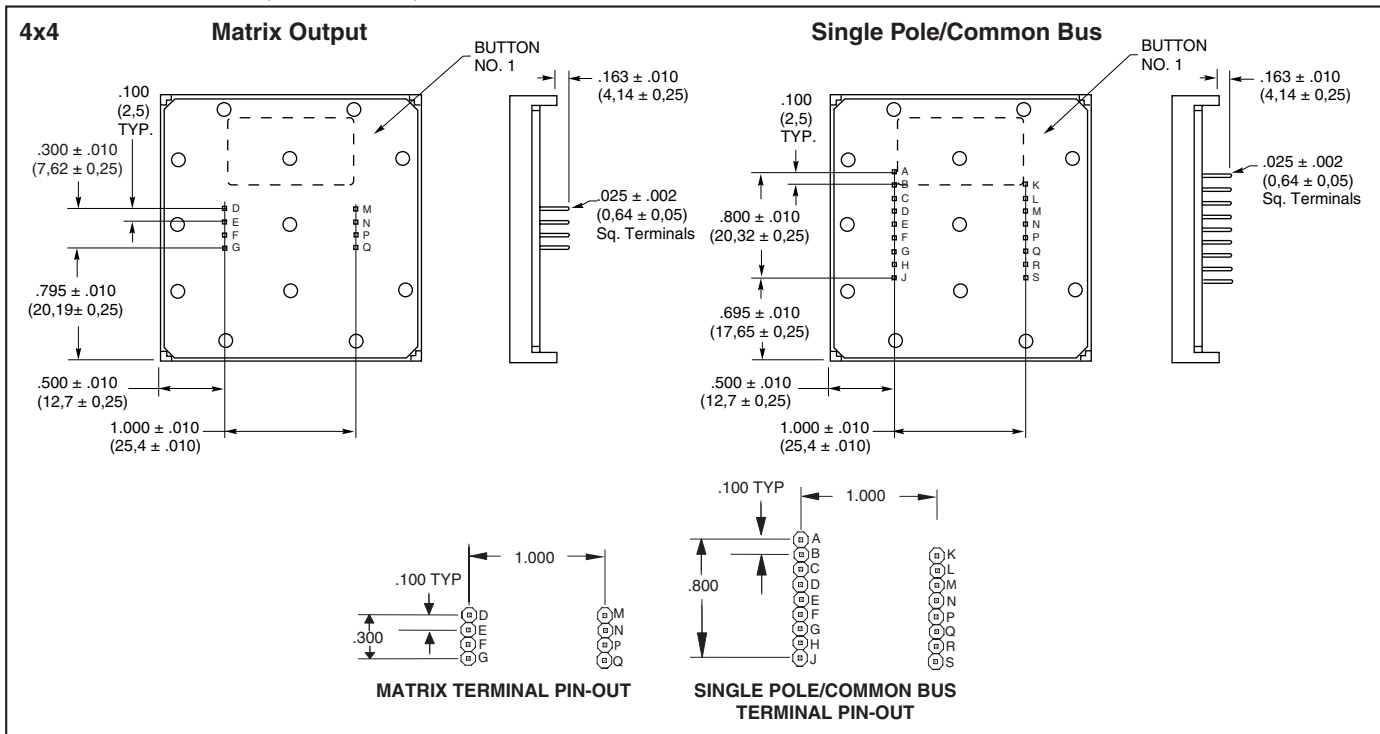

Keyboards and Keypads

**CIRCUITRY, CODE AND TRUTH TABLES**

**Circuitry for Module Strips**

The one-button thru six-button modules have single pole/common bus circuitry as shown in the circuit diagram. The common is located under button A; it is not marked on the actual product.

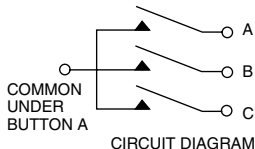

**Code and Truth Table**

Dots in the chart indicate connected terminals when switch is closed. Terminals are identified on the keyboard.

		3x4		4x4	
		Matrix	Single Pole/Common Bus	Matrix	Single Pole/Common Bus
BUTTON LOCATION	1	•	•	•	•
	2	•	•	•	•
	3	•	•	•	•
	4	•	•	•	•
	5	•	•	•	•
	6	•	•	•	•
	7	•	•	•	•
	8	•	•	•	•
	9	•	•	•	•
	10	•	•	•	•
	11	•	•	•	•
	12	•	•	•	•
		K D E B C L M	K H A J C B M E F L N G D	M N G F D E P Q	K N B A L M D C Q P F G S R E H J
		TERMINAL LOCATION		TERMINAL LOCATION	

**SPECIFICATIONS**

**Rating**

- Rating at 24 Vdc:** 10 milliamps, resistive
- Contact Resistance:** MOS, CMOS, TTL, DTL compatible (10 ohms maximum)
- Voltage Breakdown:** 250 Vac between mutually insulated parts
- Insulation Resistance:** 1,000 megohms min.
- Life Expectancy:** 3,000,000 operations per button
- Contact Bounce:** Less than 4 milliseconds at make, 10 milliseconds at break

**Materials and Finishes**

- Housing:** ABS polycarbonate, black
- Buttons:** ABS plastic, white. Legends are black.
- Snap-On-Cap:** Clear polycarbonate
- Contact Dome:** Stainless steel, selectively gold-plated
- Terminals:** Phosphor bronze

**Operating Features**

- Button Travel:** 0.011" (0,28) nominal, total travel
- Operating Temperature:** -40°C to +80°C
- Typical Operating Force:** 300 grams
- Mounting:** Mounts to 1/32" to 1/8" thick PC board

## STANDARD LEGENDS

### Insertable Style Modules

#### For prototypes and small quantities

Standard insertable legend modules are an economical way to create your own keyboard legend. Just remove the clear button cap, add any legend, and replace the snap-on cap.

### Legend Inserts

#### For insertable legend modules

Give your keyboard modules the appearance of being printed without the cost. Self-adhesive, printed legend inserts are die cut to fit the buttons. Legend sheet includes commonly used symbols, terms, alpha characters A-Z, and numeric characters 0-99 in News Gothic Condensed typestyle, printed in black on clear backing. Legend sheets also include blank inserts for dry transfer lettering.

87 Series Legend Sheet **Part No. 87AC2046**

### Dry Transfer Legends

#### For additional legend inserts

Sheets include A thru Z in upper and lower case, the numeric characters 0 thru 9, as well as commonly used symbols. The typestyle and size are similar to the chart for printed legends shown below.

Small Print

**Part No. 87-DT-2096-088**

Medium Print

**Part No. 87-DT-2096-125**

Large Print

**Part No. 87-DT-2096-187**

## SPECIAL LEGENDS

### Printed Legends

#### For medium volume or short runs

Virtually any character, symbol or pattern which can be photographed can be printed on the button. Grayhill uses epoxy ink which bonds to the surface of the button.

The legend can be printed on either of two surfaces: the top surface of a one-piece button, or the internal surface on the snap-on cap style for maximum wear.

The typestyle chart shows the style and the approximate limitations of Grayhill's standard type. However, limitations differ with the surface to be printed and the actual characters to be used. If your legend exceeds the chart limits, contact Grayhill for more information. Unless specified, black legends are printed on white buttons.

**Additional Ink Color:** White ink is stocked for use on dark colored buttons.

**Additional Button Colors:** For a molding charge, we can provide buttons from other colors which we may have in stock, such as black, red, green, blue, or yellow. Non-stock button/ink colors may require minimum material purchase. To order, or to check currently stocked colors, contact Grayhill.

Type No. and Typical Height	Sample Style and Typical Sizes	Sub Surface Character and Line Limitations	Top Surface Character and Line Limitations
4GH088 .083"	ABCDEFGH	4 Characters 2 Lines 	4 Characters 2 Lines 
1GH125 .138"	ABCDE	3 Characters 1 Line 	3 Characters 1 Line 
3GH187 .207"	ABCD	2 Characters 1 Line 	2 Characters 1 Line 
2GH250 .276"	ABC	N/A N/A	2 Characters 1 Line 

### Molded-in Legends

#### For high volume production

For legends that will stand up to abuse and constant wear for the life of your keyboard, use molded-in legends. The two-shot molding process molds the legend and button together. Your special legend can be made from existing Grayhill molds or we can tool special ones.

Buttons are available with black legends molded in white or other light backgrounds, or with white legends molded into dark backgrounds. See Printed Buttons, Additional Button Colors. To order, contact Grayhill.





## ORDERING INFORMATION

Type of Module or Legend	Part Number
1 Button	<b>87CC3-201</b>
2 Button	<b>87DC3-201</b>
3 Button	<b>87EC3-201</b>
4 Button	<b>87FC3-201</b>
5 Button	<b>87GC3-201</b>
6 Button	<b>87HC3-201</b>
12 Button–Matrix	<b>87AB3-201</b>
12 Button–SP/Com Bus	<b>87AC3-201</b>
16 Button–Matrix	<b>87BB3-201</b>
16 Button–SP/Com Bus	<b>87BC3-201</b>
Insertable Legend Card	<b>87AC2046</b>
Dry Transfer–Small	<b>87-DT-2096-088</b>
Dry Transfer–Medium	<b>87-DT-2096-125</b>
Dry Transfer–Large	<b>87-DT-2096-187</b>

### Special Legends

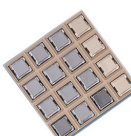
To order non-standard modules, information is required for the areas listed below. Your special order will be assigned a part number for future identification. This number is sequentially assigned and is non-descriptive.

- Type of Module.** 1, 2, 3, 4, 5, 6, 12 or 16 button.
- Mounting Orientation.** Horizontal or vertical.
- Circuitry.** Single pole/common bus is standard for all single row modules. For 12 or 16 button keyboard, specify single pole/common bus or matrix.
- Housing Color.** Standard housing is black. Optional stock colors include beige and gray.

- Button Types.** Flat or concave buttons are available for molded legends; flat, concave, and snap-on cap styles are available for printed legends.
- Button Color.** Standard buttons for molded and printed legends are white with black legend. Other colors available include white legends with red, green, dark blue, dark gray and black buttons, or black legends with yellow, blue, light gray, beige and white buttons. Additional legend colors such as red are also available.
- Legend Style.** Two-shot molded or printed. Printed legends may be top or sub-surface printed.
- Actual Legend.** Specify for each button using the button identification on drawings.

**Price—Contact Grayhill.**



## Стандарт Электрон Связь

Мы молодая и активно развивающаяся компания в области поставок электронных компонентов. Мы поставляем электронные компоненты отечественного и импортного производства напрямую от производителей и с крупнейших складов мира.

Благодаря сотрудничеству с мировыми поставщиками мы осуществляем комплексные и плановые поставки широчайшего спектра электронных компонентов.

Собственная эффективная логистика и склад в обеспечивает надежную поставку продукции в точно указанные сроки по всей России.

Мы осуществляем техническую поддержку нашим клиентам и предпродажную проверку качества продукции. На все поставляемые продукты мы предоставляем гарантию .

Осуществляем поставки продукции под контролем ВП МО РФ на предприятия военно-промышленного комплекса России , а также работаем в рамках 275 ФЗ с открытием отдельных счетов в уполномоченном банке. Система менеджмента качества компании соответствует требованиям ГОСТ ISO 9001.

Минимальные сроки поставки, гибкие цены, неограниченный ассортимент и индивидуальный подход к клиентам являются основой для выстраивания долгосрочного и эффективного сотрудничества с предприятиями радиоэлектронной промышленности, предприятиями ВПК и научно-исследовательскими институтами России.

С нами вы становитесь еще успешнее!

### Наши контакты:

**Телефон:** +7 812 627 14 35

**Электронная почта:** [sales@st-electron.ru](mailto:sales@st-electron.ru)

**Адрес:** 198099, Санкт-Петербург,  
Промышленная ул, дом № 19, литера Н,  
помещение 100-Н Офис 331