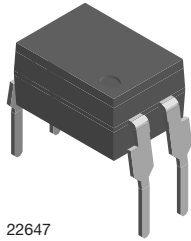
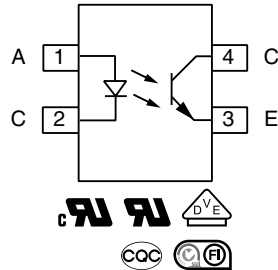


Low Input Current Optocoupler, Phototransistor Output, High Reliability, 5300 V_{RMS}



22647



DESCRIPTION

The 110 °C rated VO615C series feature a high current transfer ratio, low coupling capacitance and high isolation voltage. These couplers have a GaAs infrared diode emitter, which is optically coupled to a silicon planar phototransistor detector, and is incorporated in a plastic DIP-4 package.

The coupling devices are designed for signal transmission between two electrically separated circuits.

FEATURES

- Copper lead-frame
- Operating temperature from -55 °C to +110 °C
- Isolation test voltage, 5300 V_{RMS}
- High collector emitter voltage, V_{CEO} = 80 V
- Low saturation voltage
- Fast switching times
- Low CTR degradation
- Low coupling capacitance
- End stackable, 0.100" (2.54 mm) spacing
- Material categorization: for definitions of compliance please see www.vishay.com/doc?99912



APPLICATIONS

- AC adapters
- SMPS
- PLC
- Factory automation
- Game consoles

AGENCY APPROVALS

The safety application model number covering all products in this datasheet is VO615C. This model number should be used when consulting safety agency documents.

- UL1577, file no. E52744
- cUL tested to CSA 22.2 bulletin 5A
- DIN EN 60747-5-5 (VDE 0884), available with option 1
- FIMKO EN60065 and EN60950-1, file no. FI 27409
- CQC GB8898-2001

ORDERING INFORMATION				
<div style="display: flex; justify-content: space-around; align-items: center;"> <div style="border: 1px solid black; padding: 2px;">V</div> <div style="border: 1px solid black; padding: 2px;">O</div> <div style="border: 1px solid black; padding: 2px;">6</div> <div style="border: 1px solid black; padding: 2px;">1</div> <div style="border: 1px solid black; padding: 2px;">5</div> <div style="border: 1px solid black; padding: 2px;">C</div> <div style="border: 1px solid black; padding: 2px;">-</div> <div style="border: 1px solid black; padding: 2px;">#</div> <div style="border: 1px solid black; padding: 2px;">X</div> <div style="border: 1px solid black; padding: 2px;">0</div> <div style="border: 1px solid black; padding: 2px;">#</div> <div style="border: 1px solid black; padding: 2px;">#</div> <div style="border: 1px solid black; padding: 2px;">T</div> </div> <p style="text-align: center;">PART NUMBER CTR BIN PACKAGE OPTION TAPE AND REEL</p>	<div style="display: flex; justify-content: space-around; align-items: center;"> <div style="text-align: center;"> <p>DIP-4</p> <p>7.62 mm</p> </div> <div style="text-align: center;"> <p>Option 6</p> <p>10.16 mm</p> </div> <div style="text-align: center;"> <p>Option 9</p> <p>> 8 mm</p> </div> </div>			
AGENCY CERTIFIED/PACKAGE	CTR (%)			
	10 mA			
UL, cUL, FIMKO, CQC	40 to 80	63 to 125	100 to 200	160 to 320
DIP-4	VO615C-1	-	-	-
VDE, UL, cUL, FIMKO, CQC (option 1)	40 to 80	63 to 125	100 to 200	160 to 320
DIP-4, 400 mil, option 6	-	VO615C-2X016	VO615C-3X016	VO615C-4X016
SMD-4, option 9	-	VO615C-2X019T, VO615C-2X019T1 ⁽¹⁾	-	-

Notes

- Additional options may be available, please contact the sales office.
- (1) T1 rotation in tape and reel packaging.

ABSOLUTE MAXIMUM RATINGS ($T_{amb} = 25\text{ }^{\circ}\text{C}$, unless otherwise specified)				
PARAMETER	TEST CONDITION	SYMBOL	VALUE	UNIT
INPUT				
Reverse voltage		V_R	6	V
Forward current		I_F	60	mA
Forward surge current	$t_p \leq 10\text{ }\mu\text{s}$	I_{FSM}	1.5	A
Power dissipation	at $25\text{ }^{\circ}\text{C}$	P_{diss}	70	mW
OUTPUT				
Collector emitter voltage		V_{CEO}	80	V
Emitter collector voltage		V_{ECO}	7	V
Collector current		I_C	50	mA
	$t_p \leq 1\text{ ms}$		100	mA
Output power dissipation	at $25\text{ }^{\circ}\text{C}$	P_{diss}	150	mW
COUPLER				
Isolation test voltage (RMS)	$t = 1\text{ min}$	V_{ISO}	5300	V_{RMS}
Total power dissipation		P_{tot}	200	mW
Operation temperature		T_{amb}	-55 to +110	$^{\circ}\text{C}$
Storage temperature range		T_{stg}	-55 to +150	$^{\circ}\text{C}$
Junction temperature		T_j	125	$^{\circ}\text{C}$
Soldering temperature ⁽¹⁾	2 mm from case, $\leq 10\text{ s}$	T_{sld}	260	$^{\circ}\text{C}$

Notes

- Stresses in excess of the absolute maximum ratings can cause permanent damage to the device. Functional operation of the device is not implied at these or any other conditions in excess of those given in the operational sections of this document. Exposure to absolute maximum ratings for extended periods of the time can adversely affect reliability.
- ⁽¹⁾ Refer to reflow profile for soldering conditions for surface mounted devices (SMD), and wave profile for soldering conditions for through hole devices (DIP), please go to "Assembly Instructions" (www.vishay.com/doc?80054).

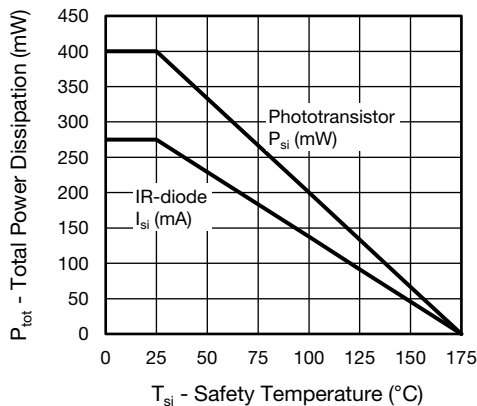


Fig. 1 - Total Power Dissipation vs. Safety Temperature

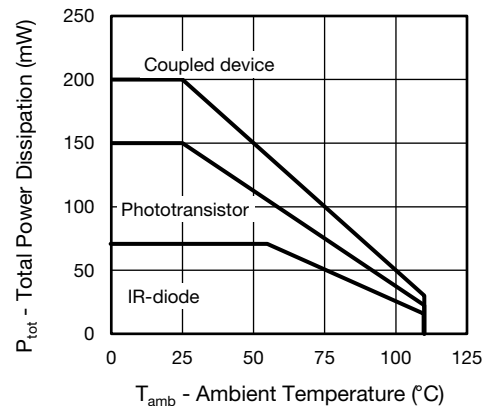


Fig. 2 - Total Power Dissipation vs. Ambient Temperature

ELECTRICAL CHARACTERISTICS ($T_{amb} = 25\text{ }^{\circ}\text{C}$, unless otherwise specified)						
PARAMETER	TEST CONDITION	SYMBOL	MIN.	TYP.	MAX.	UNIT
INPUT						
Forward voltage	$I_F = 60\text{ mA}$	V_F		1.35	1.6	V
Reverse current	$V_R = 6\text{ V}$	I_R		0.01	10	μA
Junction capacitance	$V_R = 0\text{ V}$, $f = 1\text{ MHz}$	C_j		9		pF
OUTPUT						
Collector emitter leakage current	$V_{CE} = 10\text{ V}$	I_{CEO}		0.3	100	nA
Collector emitter capacitance	$V_{CE} = 5\text{ V}$, $f = 1\text{ MHz}$	C_{CE}		2.8		pF
Collector emitter breakdown voltage	$I_C = 1\text{ mA}$	BV_{CEO}	80			V
Emitter collector breakdown voltage	$I_E = 100\text{ }\mu\text{A}$	BV_{ECO}	7			V
COUPLER						
Collector emitter saturation voltage	$I_F = 10\text{ mA}$, $I_C = 2.5\text{ mA}$	V_{CEsat}		0.25	0.4	V
Coupling capacitance	$f = 1\text{ MHz}$	C_C		0.4		pF
Cut-off frequency	$I_F = 10\text{ mA}$, $V_{CC} = 5\text{ V}$, $R_L = 100\text{ }\Omega$	f_{ctr}		110		kHz

Note

- Minimum and maximum values are testing requirements. Typical values are characteristics of the device and are the result of engineering evaluation. Typical values are for information only and are not part of the testing requirements.

CURRENT TRANSFER RATIO ($T_{amb} = 25\text{ }^{\circ}\text{C}$, unless otherwise specified)							
PARAMETER	TEST CONDITION	PART	SYMBOL	MIN.	TYP.	MAX.	UNIT
I_C/I_F	$I_F = 10\text{ mA}$, $V_{CE} = 5\text{ V}$	VO615C-1	CTR	40		80	%
		VO615C-2	CTR	63		125	%
		VO615C-3	CTR	100		200	%
		VO615C-4	CTR	160		320	%

SWITCHING CHARACTERISTICS ($T_{amb} = 25\text{ }^{\circ}\text{C}$, unless otherwise specified)						
PARAMETER	TEST CONDITION	SYMBOL	MIN.	TYP.	MAX.	UNIT
NON-SATURATED						
Rise time	$I_C = 2\text{ mA}$, $V_{CC} = 5\text{ V}$, $R_L = 100\text{ }\Omega$	t_r		3		μs
Fall time		t_f		3		μs
Turn-on time		t_{on}		6		μs
Turn-off time		t_{off}		4		μs

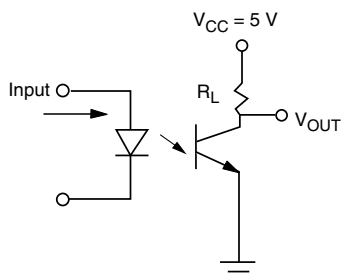


Fig. 3 - Test Circuit

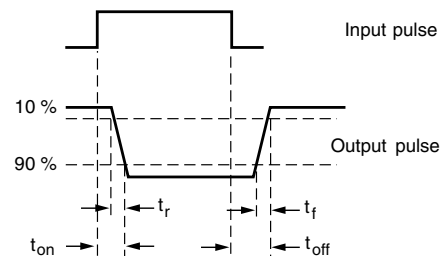


Fig. 4 - Test Circuit and Waveforms

SAFETY AND INSULATION RATINGS				
PARAMETER		SYMBOL	VALUE	UNIT
MAXIMUM SAFETY RATINGS				
Output safety power		P_{SO}	700	mW
Input safety current		I_{si}	400	mW
Safety temperature		T_S	175	°C
Comparative tracking index		CTI	175	
INSULATION RATED PARAMETERS				
Maximum withstanding isolation voltage		V_{ISO}	5300	V_{RMS}
Maximum transient isolation voltage		V_{IOTM}	8000	V_{peak}
Maximum repetitive peak isolation voltage		V_{IORM}	565	V_{peak}
		$V_{IORM}^{(1)}$	1140	V_{peak}
Insulation resistance		$T_{amb} = 25\text{ °C}, V_{DC} = 500\text{ V}$	R_{IO}	$\geq 10^{12}$
Isolation resistance		$T_{amb} = 100\text{ °C}, V_{DC} = 500\text{ V}$	R_{IO}	$\geq 10^{11}$
Climatic classification (according to IEC 68 part 1)				55/110/21
Environment (pollution degree in accordance to DIN VDE 0109)				2
Internal and external creepage		Standard DIP-4		≥ 7
		400 mil DIP-4		≥ 8
Clearance		Standard DIP-4		≥ 7
		400 mil DIP-4		≥ 8
Insulation thickness				0.4
				mm

Notes

- As per DIN EN 60747-5-5, 2, § 7.4.3.8.2, this optocoupler is suitable for “safe electrical insulation” only within the safety ratings. Compliance with the safety ratings shall be ensured by means of protective circuits.
- ⁽¹⁾ Only for option 6.

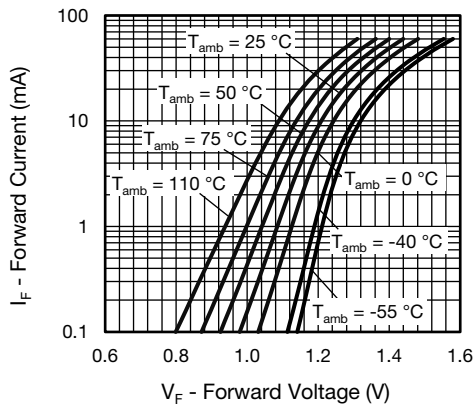
TYPICAL CHARACTERISTICS ($T_{amb} = 25\text{ °C}$, unless otherwise specified)


Fig. 5 - Forward Voltage vs. Forward Current

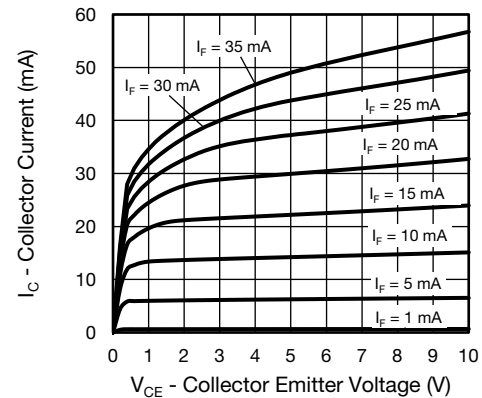


Fig. 6 - Collector Current vs. Collector Emitter Voltage (NS)

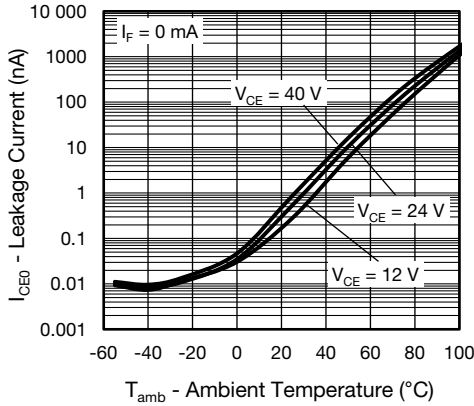


Fig. 7 - Leakage Current vs. Ambient Temperature

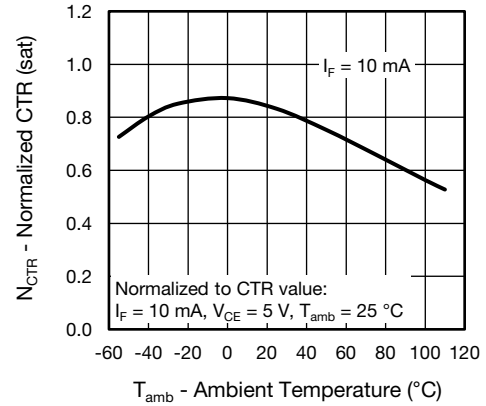


Fig. 10 - Normalized Current Transfer Ratio (saturated) vs. Ambient Temperature

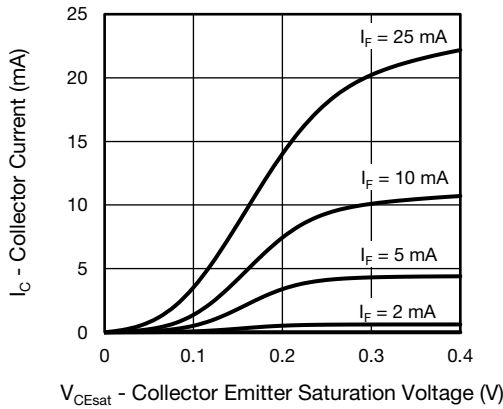


Fig. 8 - Collector Current vs. Collector Emitter Voltage (saturated)

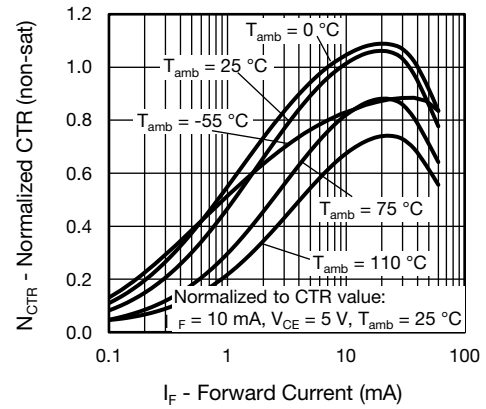


Fig. 11 - Normalized CTR (non-saturated) vs. Forward Current

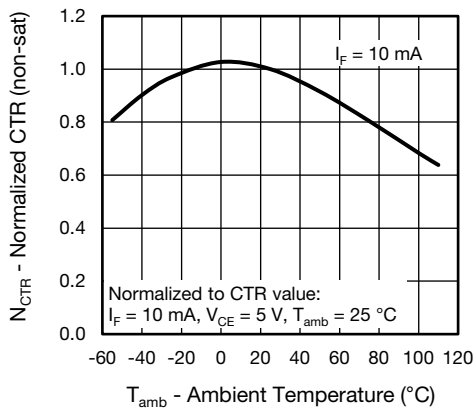


Fig. 9 - Normalized Current Transfer Ratio (non-saturated) vs. Ambient Temperature

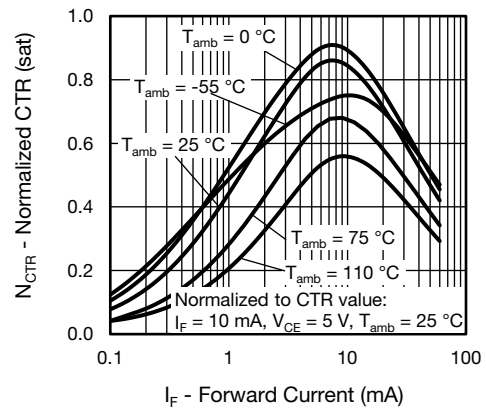


Fig. 12 - Normalized CTR (saturated) vs. Forward Current

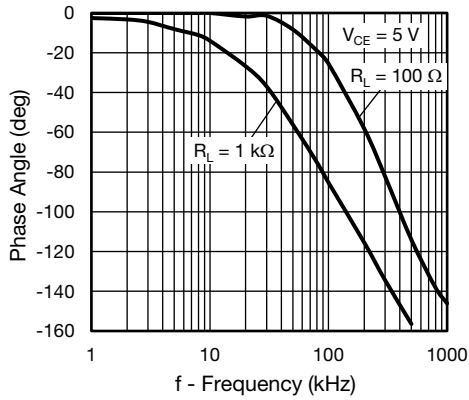


Fig. 13 - Phase Angle vs. Frequency

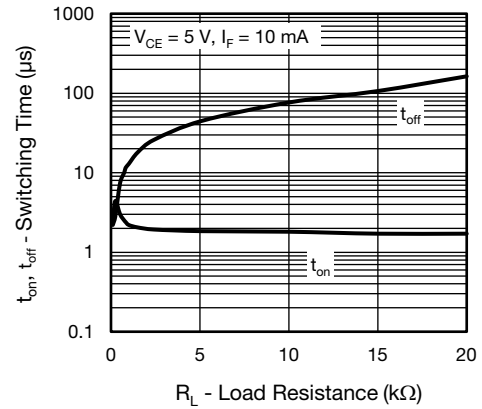


Fig. 15 - Switching Time vs. Load Resistance

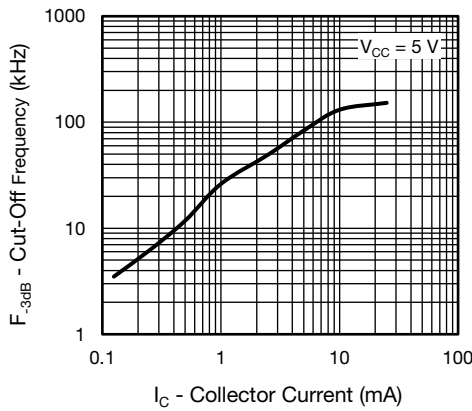


Fig. 14 - Frequency vs. Collector Current

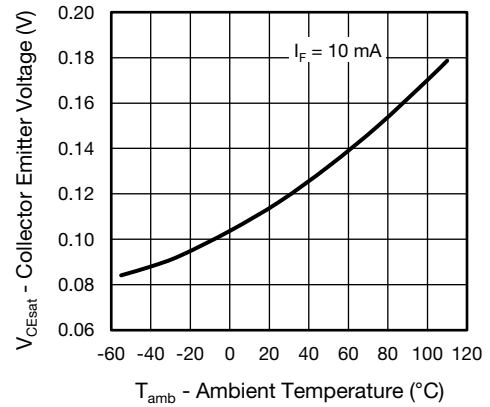
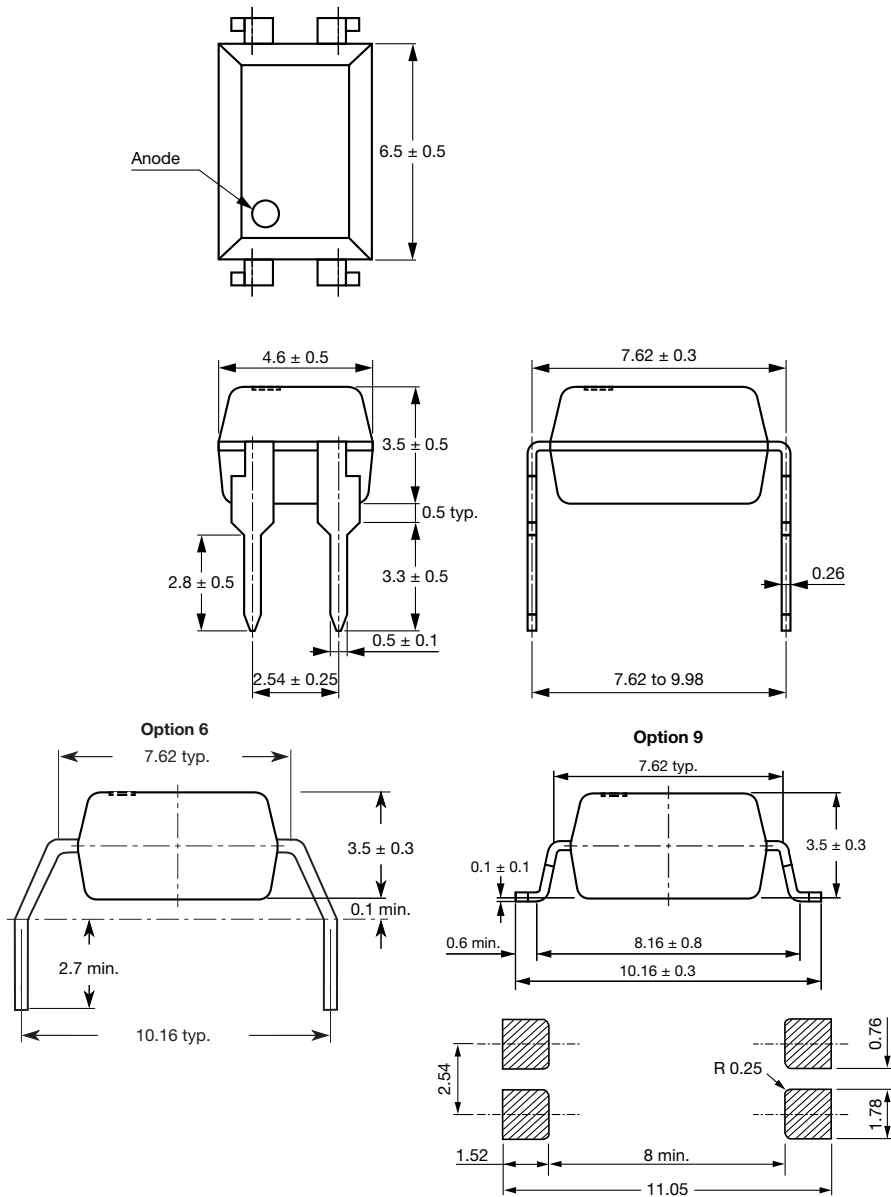
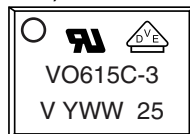


Fig. 16 - Collector Emitter Voltage vs. Ambient Temperature (saturated)

PACKAGE DIMENSIONS in millimeters



PACKAGE MARKING (Example of VO615C-3X016)



Note

- Option information is not marked.

PACKING INFORMATION

DEVICE PER TUBE			
TYPE	UNITS/TUBE	TUBES/BOX	UNITS/BOX
DIP-4	100	40	4000

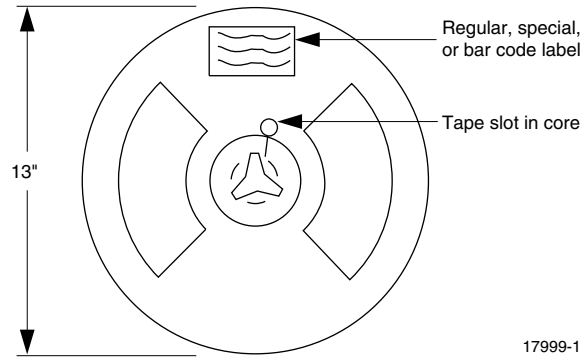


Fig. 17 - Tape and Reel Shipping Medium

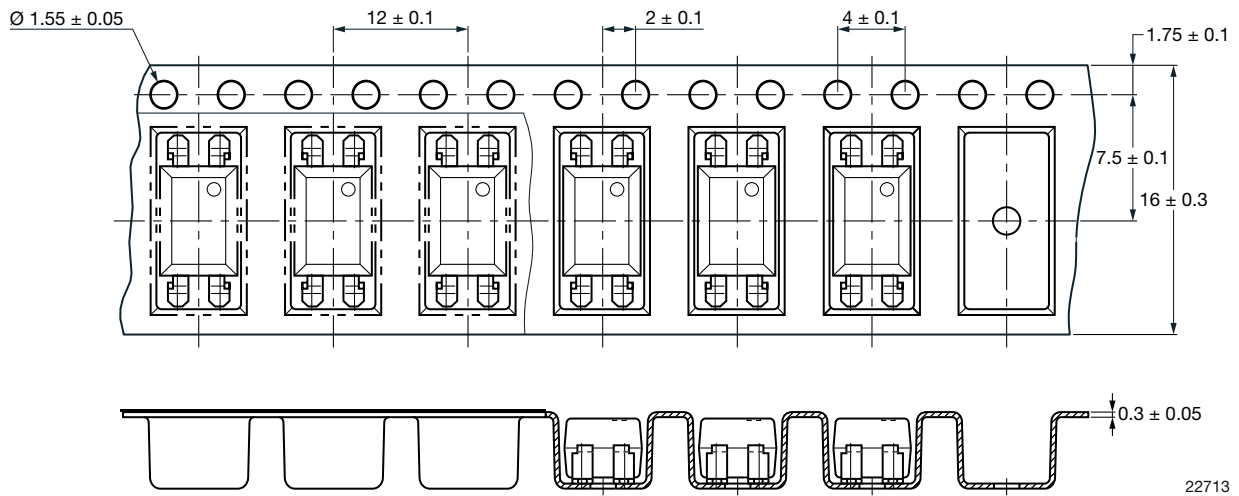


Fig. 18 - Tape Packing for Option 7 and 9, T1 rotation (2000 units per reel)



Disclaimer

ALL PRODUCT, PRODUCT SPECIFICATIONS AND DATA ARE SUBJECT TO CHANGE WITHOUT NOTICE TO IMPROVE RELIABILITY, FUNCTION OR DESIGN OR OTHERWISE.

Vishay Intertechnology, Inc., its affiliates, agents, and employees, and all persons acting on its or their behalf (collectively, "Vishay"), disclaim any and all liability for any errors, inaccuracies or incompleteness contained in any datasheet or in any other disclosure relating to any product.

Vishay makes no warranty, representation or guarantee regarding the suitability of the products for any particular purpose or the continuing production of any product. To the maximum extent permitted by applicable law, Vishay disclaims (i) any and all liability arising out of the application or use of any product, (ii) any and all liability, including without limitation special, consequential or incidental damages, and (iii) any and all implied warranties, including warranties of fitness for particular purpose, non-infringement and merchantability.

Statements regarding the suitability of products for certain types of applications are based on Vishay's knowledge of typical requirements that are often placed on Vishay products in generic applications. Such statements are not binding statements about the suitability of products for a particular application. It is the customer's responsibility to validate that a particular product with the properties described in the product specification is suitable for use in a particular application. Parameters provided in datasheets and/or specifications may vary in different applications and performance may vary over time. All operating parameters, including typical parameters, must be validated for each customer application by the customer's technical experts. Product specifications do not expand or otherwise modify Vishay's terms and conditions of purchase, including but not limited to the warranty expressed therein.

Except as expressly indicated in writing, Vishay products are not designed for use in medical, life-saving, or life-sustaining applications or for any other application in which the failure of the Vishay product could result in personal injury or death. Customers using or selling Vishay products not expressly indicated for use in such applications do so at their own risk. Please contact authorized Vishay personnel to obtain written terms and conditions regarding products designed for such applications.

No license, express or implied, by estoppel or otherwise, to any intellectual property rights is granted by this document or by any conduct of Vishay. Product names and markings noted herein may be trademarks of their respective owners.

Material Category Policy

Vishay Intertechnology, Inc. hereby certifies that all its products that are identified as RoHS-Compliant fulfill the definitions and restrictions defined under Directive 2011/65/EU of The European Parliament and of the Council of June 8, 2011 on the restriction of the use of certain hazardous substances in electrical and electronic equipment (EEE) - recast, unless otherwise specified as non-compliant.

Please note that some Vishay documentation may still make reference to RoHS Directive 2002/95/EC. We confirm that all the products identified as being compliant to Directive 2002/95/EC conform to Directive 2011/65/EU.

Vishay Intertechnology, Inc. hereby certifies that all its products that are identified as Halogen-Free follow Halogen-Free requirements as per JEDEC JS709A standards. Please note that some Vishay documentation may still make reference to the IEC 61249-2-21 definition. We confirm that all the products identified as being compliant to IEC 61249-2-21 conform to JEDEC JS709A standards.



Стандарт Электрон Связь

Мы молодая и активно развивающаяся компания в области поставок электронных компонентов. Мы поставляем электронные компоненты отечественного и импортного производства напрямую от производителей и с крупнейших складов мира.

Благодаря сотрудничеству с мировыми поставщиками мы осуществляем комплексные и плановые поставки широчайшего спектра электронных компонентов.

Собственная эффективная логистика и склад в обеспечивает надежную поставку продукции в точно указанные сроки по всей России.

Мы осуществляем техническую поддержку нашим клиентам и предпродажную проверку качества продукции. На все поставляемые продукты мы предоставляем гарантию .

Осуществляем поставки продукции под контролем ВП МО РФ на предприятия военно-промышленного комплекса России , а также работаем в рамках 275 ФЗ с открытием отдельных счетов в уполномоченном банке. Система менеджмента качества компании соответствует требованиям ГОСТ ISO 9001.

Минимальные сроки поставки, гибкие цены, неограниченный ассортимент и индивидуальный подход к клиентам являются основой для выстраивания долгосрочного и эффективного сотрудничества с предприятиями радиоэлектронной промышленности, предприятиями ВПК и научно-исследовательскими институтами России.

С нами вы становитесь еще успешнее!

Наши контакты:

Телефон: +7 812 627 14 35

Электронная почта: sales@st-electron.ru

Адрес: 198099, Санкт-Петербург,
Промышленная ул, дом № 19, литера Н,
помещение 100-Н Офис 331