

DS64BR401EVK User Guide

SATA/SAS MiniSAS4X Cable Extender Demo Kit

General Description:

The DS64BR401EVK – miniSAS4X cable extender demonstration kit provides a complete cable extension solution using National's DS64BR401 – Quad Bi-directional Cable/Backplane Extender with Equalization and De-emphasis.

MiniSAS4X right angle I-PASS Molex receptacle connectors are used as the input and the output connections for SATA/SAS disk drive storage application. Adaptor board which provides connection from mini SAS4X (26-pin external) to mini SAS4Xi (36-pin internal) is provided to allow easy straight forward connection to existing hardware.

Features:

- Quad lane bi-directional transceiver up to 6.4 Gbps rate
- Signal conditioning on input and output for extended reach
- Adjustable receive equalization up to +33 dB gain
- Adjustable transmit de-emphasis up to -12 dB
- Adjustable transmit VOD (600 mVp-p to 1200 mVp-p)
- <0.25 UI of residual DJ at 6.4 Gbps with 40" FR4 trace
- Automatic de-emphasis scaling based on rate detect
- SATA/SAS: OOB signal pass-through, <3 ns (typ) envelope distortion
- Adjustable electrical IDLE detect threshold
- Low power (100 mW/channel), per-channel power down
- Programmable via pin selection or SMBus interface
- Single supply operation at 2.5V ±5%
- >6 kV HBM ESD Rating
- 3.3V LVCMOS input tolerant for SMBus interface
- High speed signal flow-through pinout package: 54-pin LLP (10 mm x 5.5 mm)

Applications:

- SATA (1.5 Gbps / 3.0 Gbps / 6.0 Gbps)
- SAS (3.0 Gbps / 6.0 Gbps)

DS64BR401EVK Demo Kit Contents:

- End User License Agreement
- DS64BR401EVK User Guide Rev.1.7
- DS64BR401 Datasheet
- DS64BR401 MiniSAS4X Demo Board REV.2
- MiniSAS4X Connector Adaptor Board (EXT to INT) REV.2

Ordering Information:

Device: DS64BR401SQ

SATA/SAS miniSAS4X Cable Extender Demo Kit: DS64BR401EVK



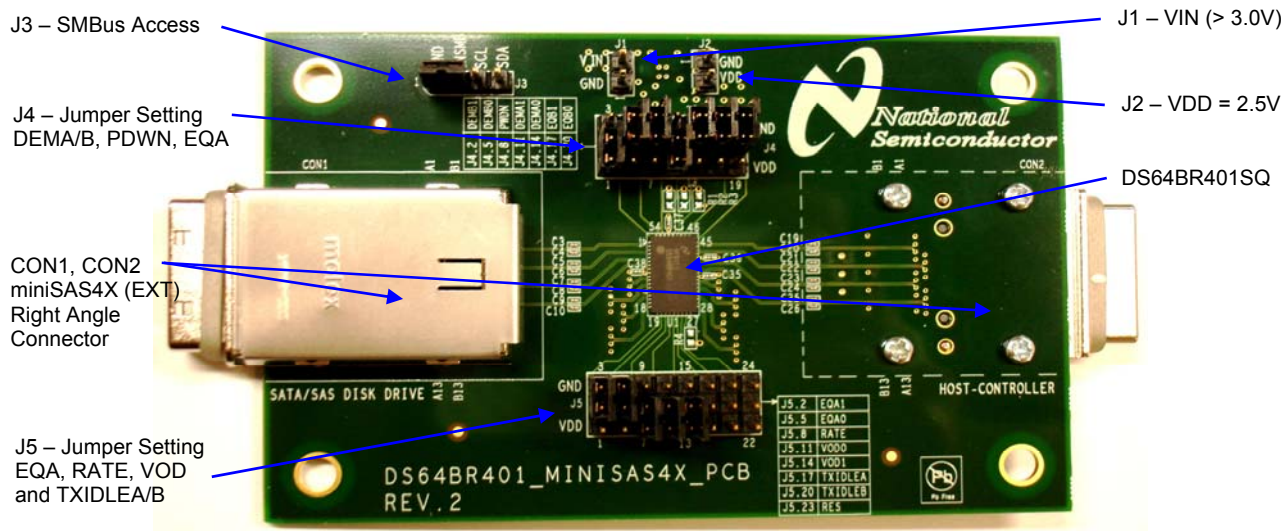

Figure 1. DS64BR401EVK Evaluation Board

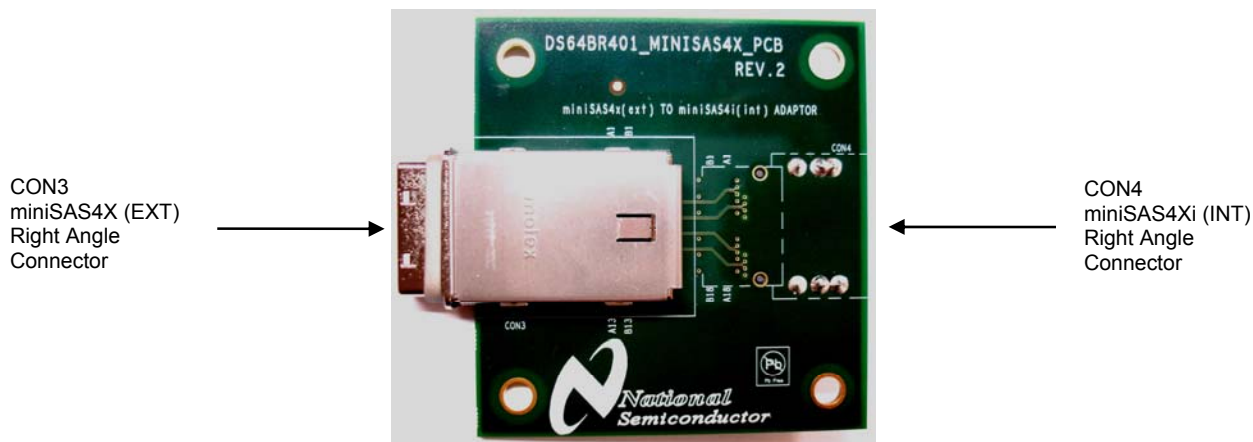
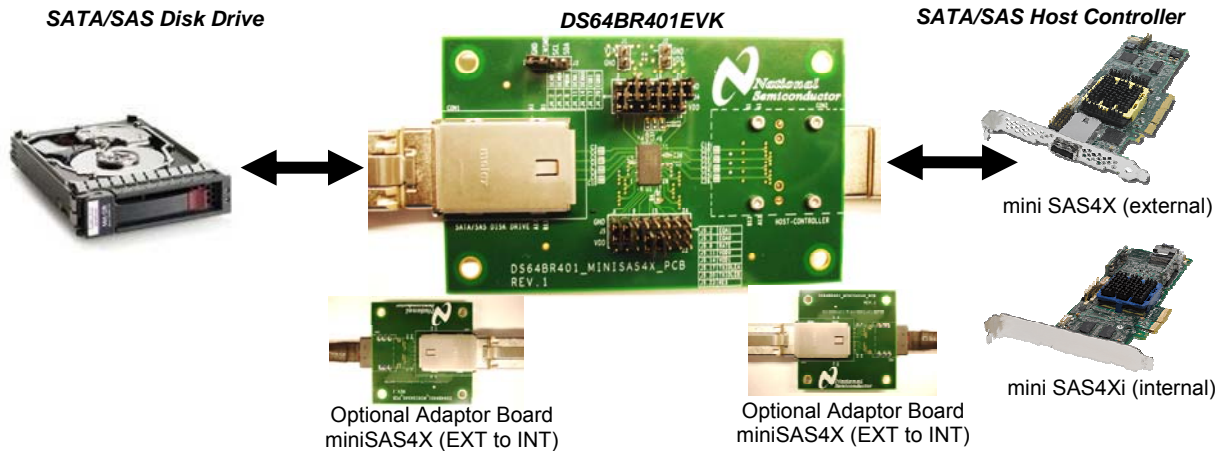

Figure 2. MiniSAS4X Connector Adaptor Board (EXT to INT)

Typical Repeater Application:



Quick Start Guide:

1. Connect > 3.0V DC power to J1. Measure 2.5 V on J2.
2. Attach two mini SAS4X external cables to the board. If cable is not the 4X external (26-pin) then use the adaptor board to convert to mini SAS4Xi (36-pin internal) connector.
3. Set EQ and DE level according to the length of the inter-connect media.

Connection and Control Description

Component	Name	Function
J1	PWR	DC Power - VIN to Low Drop-out Regulator - VIN > 3.0V.
J2	PWR	DC Power - VOUT of Low Drop-out Regulator – fixed 2.5V.
J3	ENSMB, SCL, SDA	Optional SMBus access pins. See datasheet for additional information.
J4	DEM, EQ and /PWDN	Control pins for De-emphasis, Equalizer and Power-down.
J5	EQ, RATE, VOD and TXIDLE pins	Control pins for Equalizer, Rate Select, Output VOD levels and TX output.
CON1	miniSAS4X Connector	Molex mini SAS4X (ext) right angle receptacle connector.
CON2	miniSAS4X Connector	Molex mini SAS4X (ext) right angle receptacle connector.
CON3	miniSAS4X Connector	Adaptor board with Molex mini SAS4X (EXT) right angle receptacle connector.
CON4	miniSAS4Xi Connector	Adaptor board with Molex mini SAS4Xi (INT) right angle receptacle connector.

J1, J2 – Power Connection

VIN (>3.0V) on J1 is needed for power. The LP38690 – 1A Low Dropout Linear Regulator is used to provide fixed 2.5V. J2 is available to allow access to the 2.5V supply. When by-passing the LP38690, the RS1 (0.01 ohm) should be removed and a 2.5V external supply can be connected to J2.

J3 – SMBus Access

J3 is used to access the SMBus to configure the DS64BR401. ENSMB should be tied low for external pin control. When ENSMB is tied high, SCL (clock input) and SDA (data input/output) are enabled.

J4, J5 – Control Pins

Jumpers should be used to tie the control pins to 1-high (VDD), 0-low (GND) or F-float (NC). The EQA, EQB, DEMA, DEMB, TXIDLEA, TXIDLEB and RATE are 3-level inputs. The PWDN is used to enable and disable the



device. PWDN should be tied low (GND) for normal operation. The VOD[1:0] are used to set the output amplitude voltage level. Please refer to the tables below for detail information.

Equalization Control Pins (EQA/EQB)

EQA/B0	EQA/B1	Equalization Level	Recommend Media Length
F	F	Off	Bypass
1	1	5.8 dB at 3 GHz	8 inch FR4 or 0.7 meter (30AWG) cable
0	0	9 dB at 3 GHz	12 inch FR4 or 1 meter (30AWG) cable
0	F	11.7 dB at 3 GHz	20 inch FR4 or 5 meter (30AWG) cable
0	1	14.6 dB at 3 GHz	25 inch FR4 or 6 meter (30AWG) cable
1	F	18.4 dB at 3 GHz	35 inch FR4 or 9 meter (30AWG) cable
1	0	20 dB at 3 GHz	40 inch FR4 or 10 meter (30AWG) cable
F	0	21.2 dB at 3 GHz	10 meter (30AWG) cable
F	1	28.4 dB at 3 GHz	12 meter (30AWG) cable

De-emphasis Control Pins (DEMA/DEMB)

DEMA1/B1	DEMA0/B0	De-emphasis Level	VOD Level
0	0	0 dB	VOD: 600 mV to 1200 mV
0	1	-3.5dB	VOD = 1000 mV
0	1	-2 dB	VOD = 1200 mV
1	0	-6 dB	VOD = 1000 mV
1	0	-3 dB	VOD = 1200 mV
1	1	-9 dB enhanced	VOD = 1000 mV
1	1	-11 dB enhanced	VOD = 1200 mV
0	F	-6 dB enhanced	VOD = 1000 mV
0	F	-8 dB enhanced	VOD = 1200 mV
1	F	-12 dB enhanced	VOD = 1000 mV
1	F	-13 dB enhanced	VOD = 1200 mV
F	0	-9 dB enhanced	VOD = 1000 + 200 mV
F	0	-10 dB enhanced	VOD = 1200 + 200 mV
F	1	-12 dB enhanced	VOD = (1000 to 1200) + 200 mV
F	F	Reserved, don't use	

Rate Control Pins (RATE)

RATE	Functional Description
0	Set the De-emphasis pulse width duration for 3 Gbps (low rate)
1	Set the De-emphasis pulse width duration for 6 Gbps (high rate).
F	Enables the auto rate select function.

TX Output Control Pins (TXIDLEA/TXIDLEB)

TXIDLEA/B	Functional Description
0	Disables the signal detect/squelch function for all outputs A or B.
1	Forces all outputs to be muted (electrical idle).
F	Enables the signal detect/squelch function for all channels. Signal detect voltage level threshold can be adjusted with an external resistor on the SD_TH pin to GND. Default level is 130 mVp-p when SD_TH is floating. Please refer to the Table 4 in the datasheet for typical resistor value.

Output Voltage Amplitude Level (VOD)

VOD1	VOD0	Functional Description
0	0	Output VOD = 600 mVp-p
0	1	Output VOD = 800 mVp-p
1	0	Output VOD = 1000 mVp-p
1	1	Output VOD = 1200 mVp-p



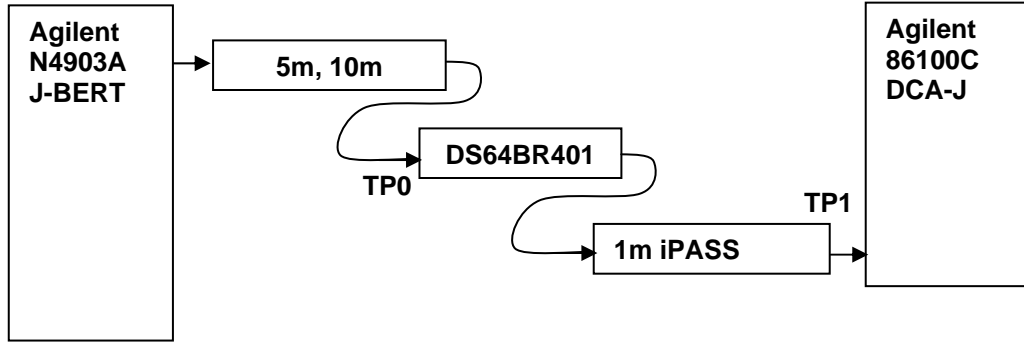
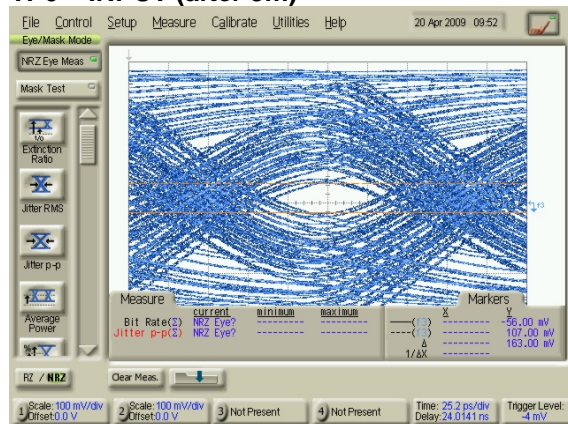
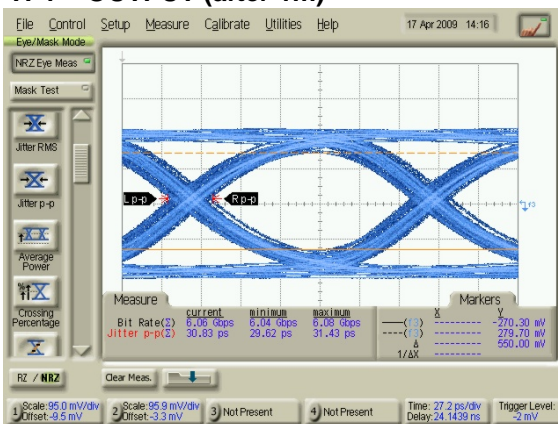

Figure 3. DS64BR401EVK Equalization Test Setup

**DS64BR401 Equalization Performance with 5m 26AWG cable at 6 Gbps:
TP0 – INPUT (after 5m) TP1 – OUTPUT (after 1m)**



VOD = 1.0 Vp-p, PRBS7



DS64BR401 setup condition:
EQ[1:0] = F0 (~11.7 dB at 3 GHz)
DEM[1:0] = 01 (-2 dB with VOD = 1.2 Vp-p)

**DS64BR401 Equalization Performance with 10m 24AWG cable at 6 Gbps:
TP0 – INPUT (after 10m) TP1 – OUTPUT (after 1m)**

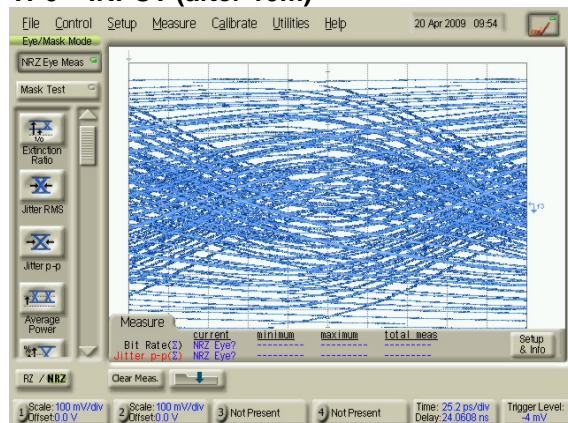

VOD = 1.0 Vp-p, PRBS7

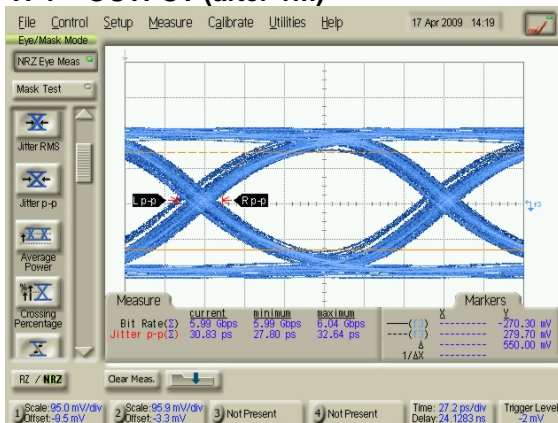

DS64BR401 setup condition:
EQ[1:0] = 01 (~20 dB at 3 GHz)
DEM[1:0] = 01 (-2 dB with VOD = 1.2 Vp-p)



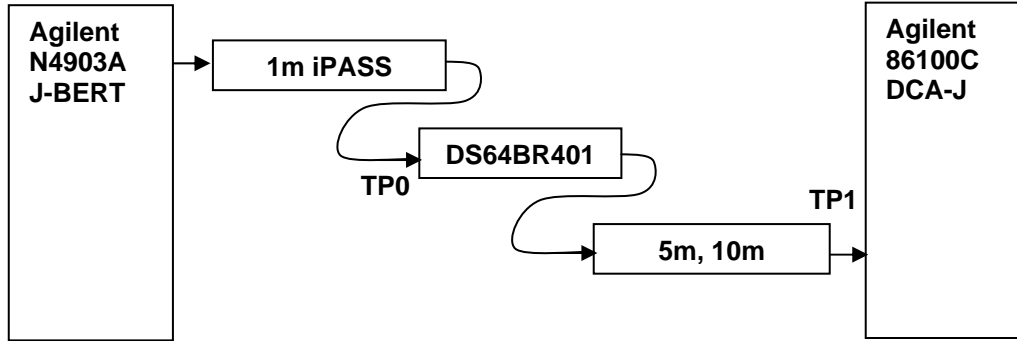
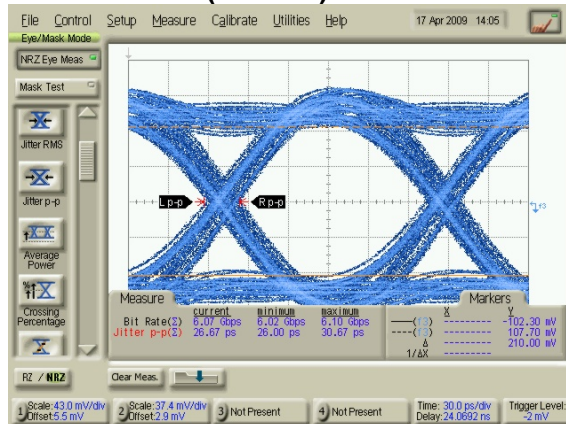
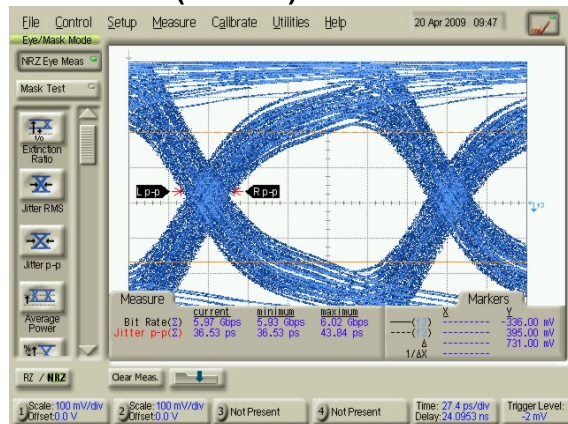

Figure 4. DS64BR401EVK De-emphasis Test Setup

DS64BR401 De-emphasis with 5m 26AWG cable at 6 Gbps:

TP0 – INPUT (after 1m)

TP1 – OUTPUT (after 5m)



VOD = 1.0 Vp-p, PRBS7

DS64BR401 setup condition:
EQ[1:0] = 11 (~5.8 dB at 3 GHz)
DEM[1:0] = F0 (-10 dB with VOD = 1.4 Vp-p)

DS64BR401 De-emphasis with 10m 24AWG cable at 6 Gbps:

TP0 – INPUT (after 1m)

TP1 – OUTPUT (after 10m)

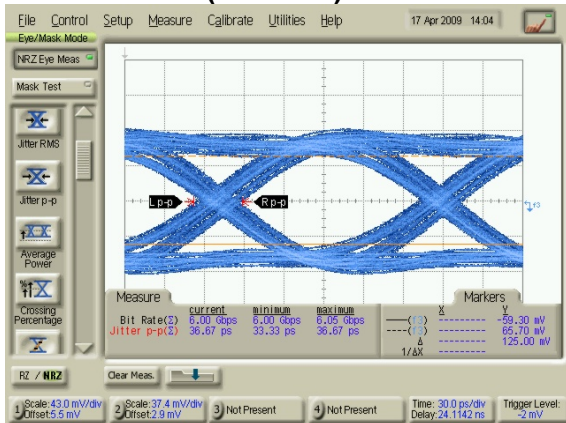
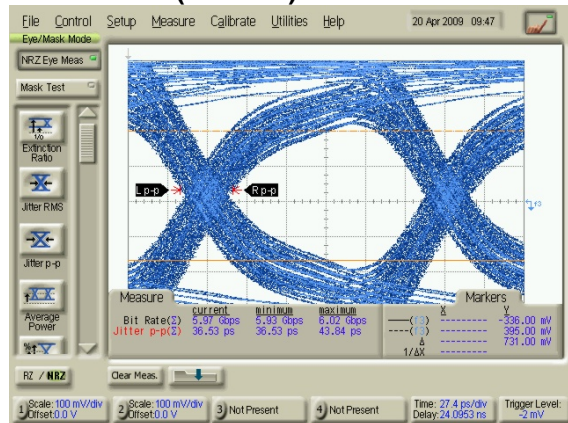

VOD = 1.0 Vp-p, PRBS7

DS64BR401 setup condition:
EQ[1:0] = 11 (~5.8 dB at 3 GHz)
DEM[1:0] = F1 (-12 dB with VOD = 1.4 Vp-p)



Scope plots of OOB (out of band) signal through the DS64BR401:

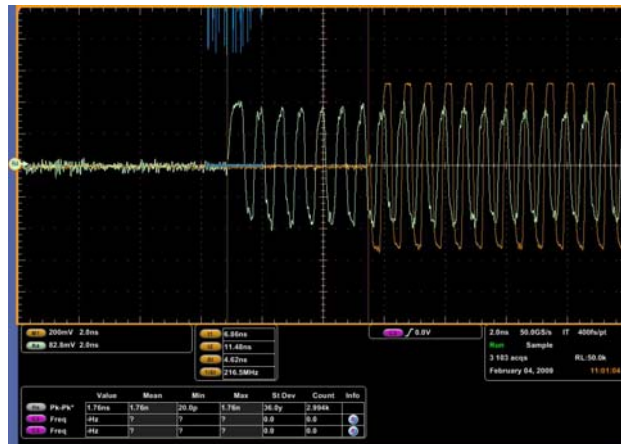

Idle to Active Response Time: ~ 4.6 ns

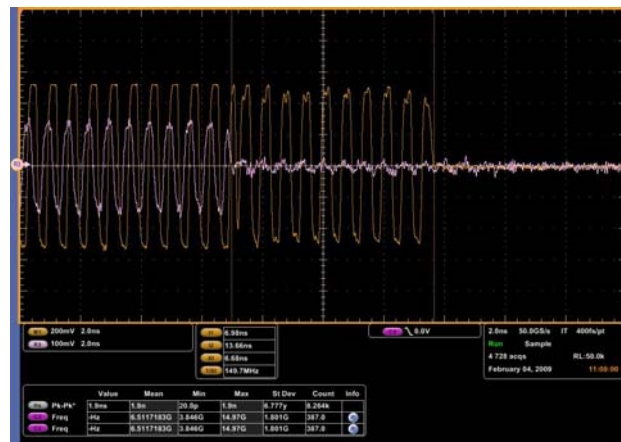

Active to Idle Response Time: ~ 6.7 ns

Bill of Materials:

DESIGNATION	QTY	DESCRIPTION
CON1,CON2,CON3	3	Molex - 75586-0009: CONN RCPT 26POS IPASS RT ANG SMD, Molex - 74548-0211: CONN IPASS SAS 1X1 GUIDE FRAME
CON4	1	Molex - 75783-0140: CONN RCPT 36POS IPASS RT ANG SMD
C1,C2	2	CAP CERAMIC 1UF 10V X5R 0402
C3,C4,C5,C6,C7,C8,C9,C10, C11,C12,C13,C14,C15,C16, C17,C18,C19,C20,C21,C22, C23,C24,C25,C26,C27,C28, C29,C30,C31,C32,C33,C34	32	CAP .01UF 6.3V CERAMIC X5R 0201
C35,C36,C37,C38,C39	5	CAP CERAMIC .1UF 6.3V X5R 0201
J1, J2	2	HEADER 1x2
J3	1	HEADER 1x4
J4	1	HEADER 3x7
J5	1	HEADER 3x8
RS1	1	RESISTOR 0.01 OHM 1/4W 1% 0805
R1,R2,R3,R4	4	NA – Only needed for special circumstance
U1	1	DS64BR401
U2	1	LP38692SD-2.5_LLP IC REG LDO 1A 2.5V 6-LLP

Schematic:

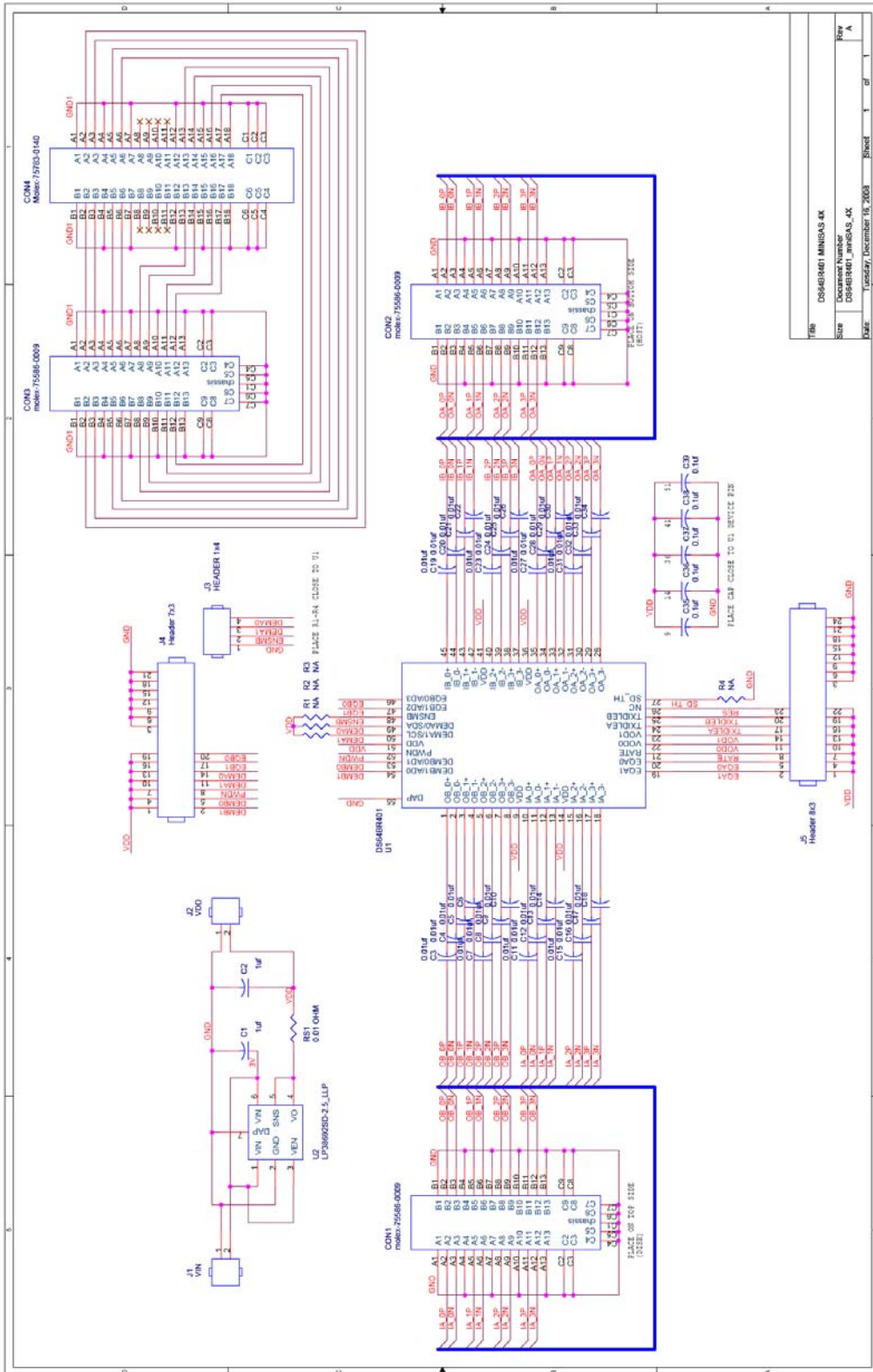

FAB/Manufacture Information:

DRILL QUANTITY TOP TO BOTTOM			
DRILL SIZE	ALL LAYERS ARE 30 MILS	PLATED	NOT PLATED
0.015	100%	100%	100%
0.020	100%	100%	100%
0.025	100%	100%	100%
0.030	100%	100%	100%
0.035	100%	100%	100%
0.040	100%	100%	100%
0.045	100%	100%	100%
0.050	100%	100%	100%
0.055	100%	100%	100%
0.060	100%	100%	100%
0.065	100%	100%	100%
0.070	100%	100%	100%
0.075	100%	100%	100%
0.080	100%	100%	100%
0.085	100%	100%	100%
0.090	100%	100%	100%
0.095	100%	100%	100%
0.100	100%	100%	100%

NOTES:

1. ALL LAYERS TO BE FRA (Er +4.7) MATERIAL, RQHS COMPLAINT.
2. ALL COPPER LAYERS SHALL BE 1 UNCE (1.4 MIL) FINISHED THICKNESS.
3. LAYER STACK-UP AS SHOWN.
4. FINISH: SFTT IMMERSION GOLD.
5. SOLDER MASK BOTH SIDES SHALL BE VENDOR'S STANDARD.
6. SILK SCREENS BOTH SIDES SHALL BE WHITE.
7. BOARD TWIST AND WARP SHALL NOT EXCEED 4MILS/LINEAR INCH.
8. EACH ASSEMBLED BOARD MUST BE PACKAGED IN A ESD BAG AND SEALED WITH AN ESD LABEL.
9. BOARD THICKNESS : 50 MILS.
10. BOARD DIMENSIONS ARE IN INCHES.
11. NO VENDOR LOGO OR NAME ON THE BOARD.
12. ANY CHANGES MADE BY THE PCB FABRICATOR TO THE FILM OR THE GERBER FILES MUST BE APPROVED BY PACTRON.
13. REMOVE THE NON-FUNCTIONAL PADS IN ALL INNER LAYERS.
14. THIS BOARD MUST BE RQHS COMPLAINT.

IMPEDANCE DETAILS:

- 5 MIL TRACEWIDTH AND 5MIL AIRGAP TRACES REQUIRE 100OHM +/-5% DIFFERENTIAL IMPEDANCE ON BOTH TOP AND BOTTOM LAYERS.
- 6 MIL SINGLE-ENDED TRACES REQUIRE 50OHM +/-10% IMPEDANCE ON TOP LAYER.
- 10 MIL SINGLE-ENDED TRACES REQUIRE 50OHM +/-10% IMPEDANCE ON INNER LAYER.

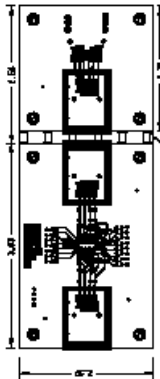
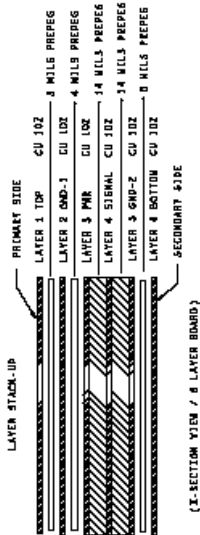

REVISION	DATE	DESCRIPTION
1	1/18/2008	INITIAL RELEASE
2	1/18/2008	DESIGN CHANGES
3	1/18/2008	DESIGN CHANGES
4	1/18/2008	DESIGN CHANGES
5	1/18/2008	DESIGN CHANGES
6	1/18/2008	DESIGN CHANGES
7	1/18/2008	DESIGN CHANGES
8	1/18/2008	DESIGN CHANGES
9	1/18/2008	DESIGN CHANGES
10	1/18/2008	DESIGN CHANGES
11	1/18/2008	DESIGN CHANGES
12	1/18/2008	DESIGN CHANGES
13	1/18/2008	DESIGN CHANGES
14	1/18/2008	DESIGN CHANGES
15	1/18/2008	DESIGN CHANGES
16	1/18/2008	DESIGN CHANGES
17	1/18/2008	DESIGN CHANGES
18	1/18/2008	DESIGN CHANGES
19	1/18/2008	DESIGN CHANGES
20	1/18/2008	DESIGN CHANGES
21	1/18/2008	DESIGN CHANGES
22	1/18/2008	DESIGN CHANGES
23	1/18/2008	DESIGN CHANGES
24	1/18/2008	DESIGN CHANGES
25	1/18/2008	DESIGN CHANGES
26	1/18/2008	DESIGN CHANGES
27	1/18/2008	DESIGN CHANGES
28	1/18/2008	DESIGN CHANGES
29	1/18/2008	DESIGN CHANGES
30	1/18/2008	DESIGN CHANGES
31	1/18/2008	DESIGN CHANGES
32	1/18/2008	DESIGN CHANGES
33	1/18/2008	DESIGN CHANGES
34	1/18/2008	DESIGN CHANGES
35	1/18/2008	DESIGN CHANGES
36	1/18/2008	DESIGN CHANGES
37	1/18/2008	DESIGN CHANGES
38	1/18/2008	DESIGN CHANGES
39	1/18/2008	DESIGN CHANGES
40	1/18/2008	DESIGN CHANGES
41	1/18/2008	DESIGN CHANGES
42	1/18/2008	DESIGN CHANGES
43	1/18/2008	DESIGN CHANGES
44	1/18/2008	DESIGN CHANGES
45	1/18/2008	DESIGN CHANGES
46	1/18/2008	DESIGN CHANGES
47	1/18/2008	DESIGN CHANGES
48	1/18/2008	DESIGN CHANGES
49	1/18/2008	DESIGN CHANGES
50	1/18/2008	DESIGN CHANGES



Document ID: DS64BR401EVK User Guide
Date: June 25, 2009
Rev: 1.7



IMPORTANT NOTICE

Texas Instruments Incorporated and its subsidiaries (TI) reserve the right to make corrections, modifications, enhancements, improvements, and other changes to its products and services at any time and to discontinue any product or service without notice. Customers should obtain the latest relevant information before placing orders and should verify that such information is current and complete. All products are sold subject to TI's terms and conditions of sale supplied at the time of order acknowledgment.

TI warrants performance of its hardware products to the specifications applicable at the time of sale in accordance with TI's standard warranty. Testing and other quality control techniques are used to the extent TI deems necessary to support this warranty. Except where mandated by government requirements, testing of all parameters of each product is not necessarily performed.

TI assumes no liability for applications assistance or customer product design. Customers are responsible for their products and applications using TI components. To minimize the risks associated with customer products and applications, customers should provide adequate design and operating safeguards.

TI does not warrant or represent that any license, either express or implied, is granted under any TI patent right, copyright, mask work right, or other TI intellectual property right relating to any combination, machine, or process in which TI products or services are used. Information published by TI regarding third-party products or services does not constitute a license from TI to use such products or services or a warranty or endorsement thereof. Use of such information may require a license from a third party under the patents or other intellectual property of the third party, or a license from TI under the patents or other intellectual property of TI.

Reproduction of TI information in TI data books or data sheets is permissible only if reproduction is without alteration and is accompanied by all associated warranties, conditions, limitations, and notices. Reproduction of this information with alteration is an unfair and deceptive business practice. TI is not responsible or liable for such altered documentation. Information of third parties may be subject to additional restrictions.

Resale of TI products or services with statements different from or beyond the parameters stated by TI for that product or service voids all express and any implied warranties for the associated TI product or service and is an unfair and deceptive business practice. TI is not responsible or liable for any such statements.

TI products are not authorized for use in safety-critical applications (such as life support) where a failure of the TI product would reasonably be expected to cause severe personal injury or death, unless officers of the parties have executed an agreement specifically governing such use. Buyers represent that they have all necessary expertise in the safety and regulatory ramifications of their applications, and acknowledge and agree that they are solely responsible for all legal, regulatory and safety-related requirements concerning their products and any use of TI products in such safety-critical applications, notwithstanding any applications-related information or support that may be provided by TI. Further, Buyers must fully indemnify TI and its representatives against any damages arising out of the use of TI products in such safety-critical applications.

TI products are neither designed nor intended for use in military/aerospace applications or environments unless the TI products are specifically designated by TI as military-grade or "enhanced plastic." Only products designated by TI as military-grade meet military specifications. Buyers acknowledge and agree that any such use of TI products which TI has not designated as military-grade is solely at the Buyer's risk, and that they are solely responsible for compliance with all legal and regulatory requirements in connection with such use.

TI products are neither designed nor intended for use in automotive applications or environments unless the specific TI products are designated by TI as compliant with ISO/TS 16949 requirements. Buyers acknowledge and agree that, if they use any non-designated products in automotive applications, TI will not be responsible for any failure to meet such requirements.

Following are URLs where you can obtain information on other Texas Instruments products and application solutions:

Products

Audio	www.ti.com/audio
Amplifiers	amplifier.ti.com
Data Converters	dataconverter.ti.com
DLP® Products	www.dlp.com
DSP	dsp.ti.com
Clocks and Timers	www.ti.com/clocks
Interface	interface.ti.com
Logic	logic.ti.com
Power Mgmt	power.ti.com
Microcontrollers	microcontroller.ti.com
RFID	www.ti-rfid.com
OMAP Mobile Processors	www.ti.com/omap
Wireless Connectivity	www.ti.com/wirelessconnectivity

Applications

Automotive and Transportation	www.ti.com/automotive
Communications and Telecom	www.ti.com/communications
Computers and Peripherals	www.ti.com/computers
Consumer Electronics	www.ti.com/consumer-apps
Energy and Lighting	www.ti.com/energy
Industrial	www.ti.com/industrial
Medical	www.ti.com/medical
Security	www.ti.com/security
Space, Avionics and Defense	www.ti.com/space-avionics-defense
Video and Imaging	www.ti.com/video

TI E2E Community Home Page

e2e.ti.com

Mailing Address: Texas Instruments, Post Office Box 655303, Dallas, Texas 75265
Copyright © 2012, Texas Instruments Incorporated



Стандарт Электрон Связь

Мы молодая и активно развивающаяся компания в области поставок электронных компонентов. Мы поставляем электронные компоненты отечественного и импортного производства напрямую от производителей и с крупнейших складов мира.

Благодаря сотрудничеству с мировыми поставщиками мы осуществляем комплексные и плановые поставки широчайшего спектра электронных компонентов.

Собственная эффективная логистика и склад в обеспечивает надежную поставку продукции в точно указанные сроки по всей России.

Мы осуществляем техническую поддержку нашим клиентам и предпродажную проверку качества продукции. На все поставляемые продукты мы предоставляем гарантию .

Осуществляем поставки продукции под контролем ВП МО РФ на предприятия военно-промышленного комплекса России , а также работаем в рамках 275 ФЗ с открытием отдельных счетов в уполномоченном банке. Система менеджмента качества компании соответствует требованиям ГОСТ ISO 9001.

Минимальные сроки поставки, гибкие цены, неограниченный ассортимент и индивидуальный подход к клиентам являются основой для выстраивания долгосрочного и эффективного сотрудничества с предприятиями радиоэлектронной промышленности, предприятиями ВПК и научно-исследовательскими институтами России.

С нами вы становитесь еще успешнее!

Наши контакты:

Телефон: +7 812 627 14 35

Электронная почта: sales@st-electron.ru

Адрес: 198099, Санкт-Петербург,
Промышленная ул, дом № 19, литера Н,
помещение 100-Н Офис 331