



# 120×120×25 mm

**San Ace 120 9G type** Model 9G1212B401 is not certified.

## General Specifications

- Material ..... Frame: Plastic (Flammability: UL 94V-0), Impeller: Plastic (Flammability: UL 94V-1)
- Expected life ..... See the table below. (L10 life: 90% survival rate for continuous operation in free air at 60°C, rated voltage)
- Motor protection function ..... Locked rotor burnout protection, Reverse polarity protection  
For details, please refer to p. 547.
- Dielectric strength ..... 50/60 Hz, 500 VAC, for 1 minute (between lead wire conductors and frame)
- Insulation resistance ..... 10 MΩ or more with a 500 VDC megger (between lead wire conductors and frame)
- Sound pressure level (SPL) ..... At 1 m away from the air inlet
- Storage temperature ..... -30 to +70°C (Non-condensing)
- Lead wire ..... ⊕Red ⊖Black or Blue (Sensor) Yellow
- Mass ..... 240 g

## Specifications

The models listed below **have ribs and pulse sensors**. For models without ribs, append "1" to the end of model numbers.

Model no.	Rated voltage [V]	Operating voltage range [V]	Rated current [A]	Rated input [W]	Rated speed [min <sup>-1</sup> ]	Max. airflow [m <sup>3</sup> /min] [CFM]	Max. static pressure [Pa] [inchH <sub>2</sub> O]	SPL [dB (A)]	Operating temperature [°C]	Expected life [h]
<b>9G1212G401</b>	12	10.2 to 13.8	0.9	10.8	4100	3.68 130	120 0.482	51	-20 to +70	40000/60°C
<b>9G1212E401</b>			0.58	6.96	3650	3.25 115	98 0.394	48		
<b>9G1212A401</b>			0.4	4.8	3150	2.83 100	77 0.309	44		
<b>9G1212H401</b>		6 to 13.8	0.31	3.72	2850	2.5 88	64 0.257	40		
<b>9G1212F401</b>		7 to 13.8	0.19	2.28	2250	1.98 70	42 0.169	35		
<b>9G1212M401</b>			0.14	1.68	1950	1.66 59	31 0.124	29		
<b>9G1212B401</b>		10.2 to 13.8	0.06	0.72	1000	0.88 31	9.6 0.039	18		
<b>9G1224G401</b>	24	20.4 to 27.6	0.47	11.28	4100	3.68 130	120 0.482	51		
<b>9G1224E401</b>			0.37	8.88	3650	3.25 115	98 0.394	48		
<b>9G1224A401</b>			0.21	5.04	3150	2.83 100	77 0.309	44		
<b>9G1224H401</b>		12 to 27.6	0.17	4.08	2850	2.5 88	64 0.257	40		
<b>9G1224F401</b>		20.4 to 27.6	0.1	2.4	2250	1.98 70	42 0.169	35		
<b>9G1224M401</b>			0.08	1.92	1950	1.66 59	31 0.124	29		
<b>9G1248G401</b>		48	40.8 to 55.2	0.23	11.04	4100	3.68 130	120 0.482		
<b>9G1248E401</b>	0.16			7.68	3650	3.25 115	98 0.394	48		
<b>9G1248A401</b>	0.13			6.24	3150	2.83 100	77 0.309	44		
<b>9G1248H401</b>	0.1			4.8	2850	2.5 88	64 0.257	40		
<b>9G1248F401</b>	0.06			2.88	2250	1.98 70	42 0.169	35		
<b>9G1248M401</b>	0.05			2.4	1950	1.66 59	31 0.124	29		

The following sensor and control options are available for selection.

Differs according to the model. Refer to the table on pp. 568 to 570. Without sensor Lock sensor PWM control

## Airflow - Static Pressure Characteristics

**9G1212G401** With pulse sensor

Operating voltage range

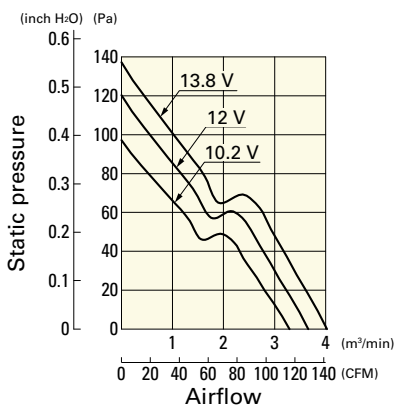

**9G1212E401** With pulse sensor

Operating voltage range

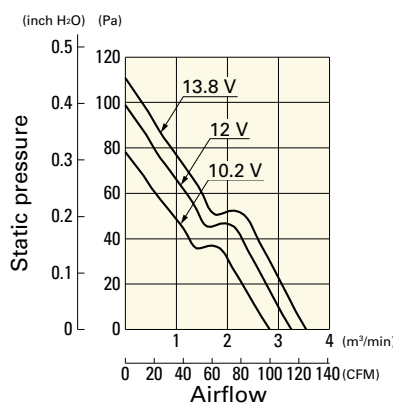

**9G1212A401** With pulse sensor

Operating voltage range

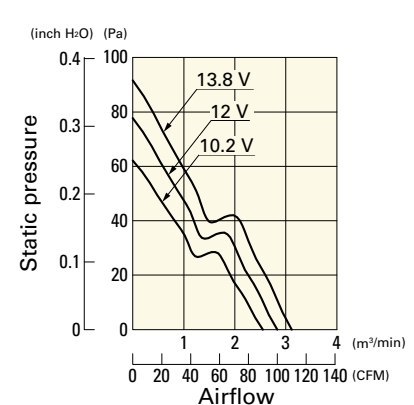

# Airflow - Static Pressure Characteristics

**9G1212H401** With pulse sensor

Operating voltage range

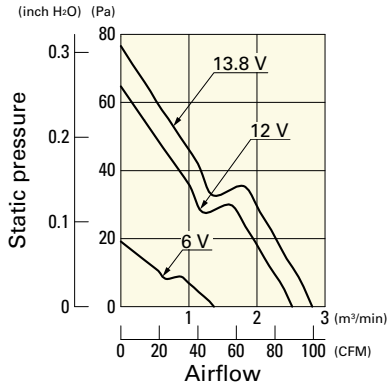

**9G1212F401** With pulse sensor

Operating voltage range

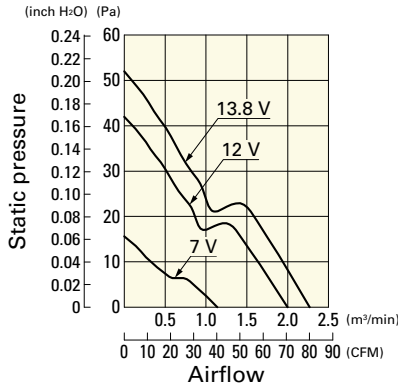

**9G1212M401** With pulse sensor

Operating voltage range

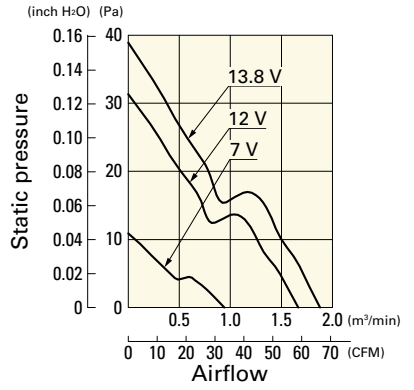

**9G1212B401** With pulse sensor

Operating voltage range

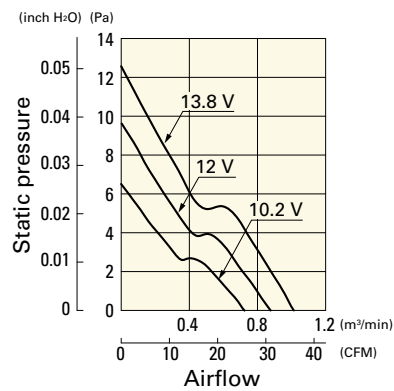

**9G1224G401** With pulse sensor

Operating voltage range

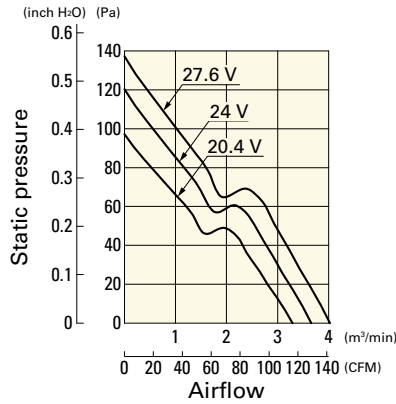

**9G1224E401** With pulse sensor

Operating voltage range

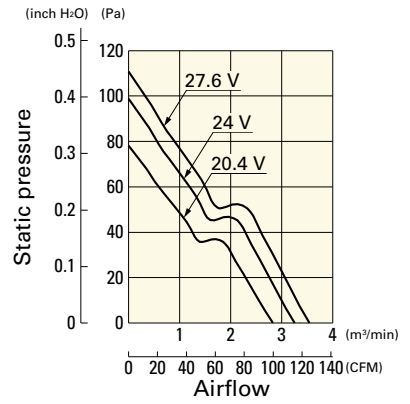

**9G1224A401** With pulse sensor

Operating voltage range

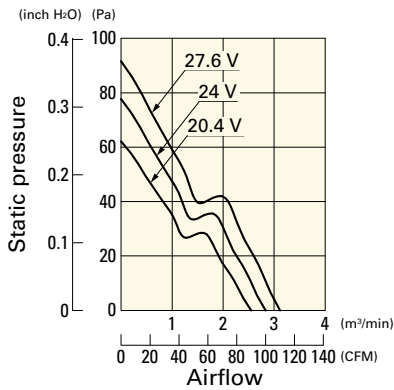

**9G1224H401** With pulse sensor

Operating voltage range

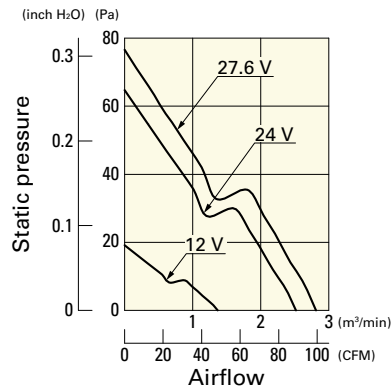

**9G1224F401** With pulse sensor

Operating voltage range

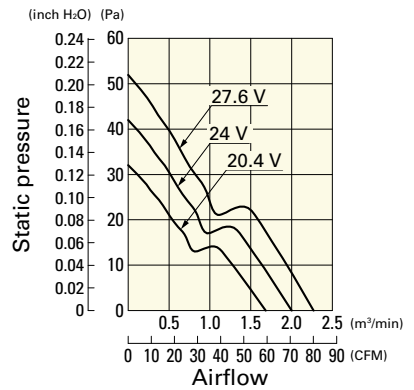

**9G1224M401** With pulse sensor

Operating voltage range

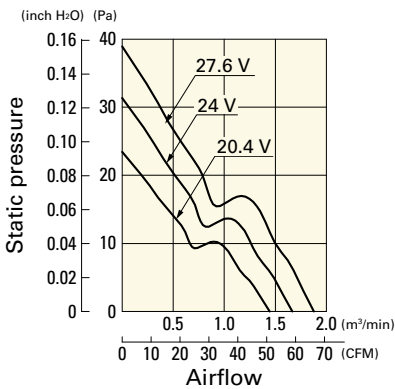

**9G1248G401** With pulse sensor

Operating voltage range

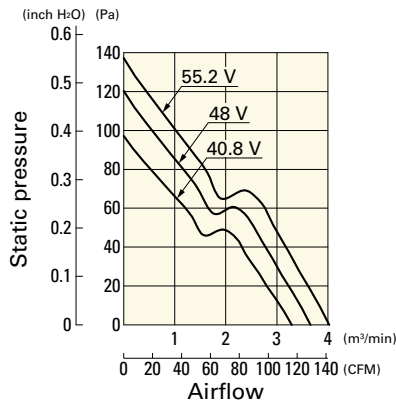

**9G1248E401** With pulse sensor

Operating voltage range

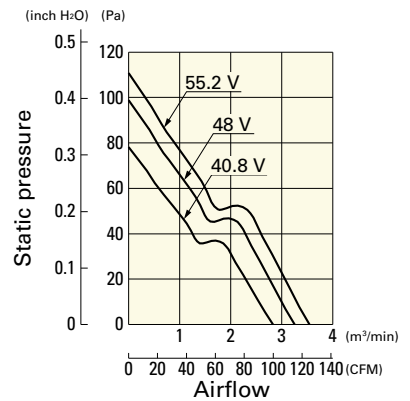

**Airflow - Static Pressure Characteristics**

**9G1248A401** With pulse sensor

Operating voltage range

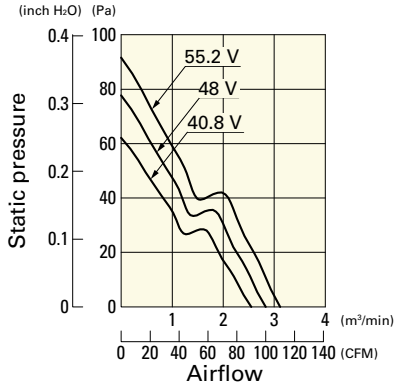

**9G1248H401** With pulse sensor

Operating voltage range

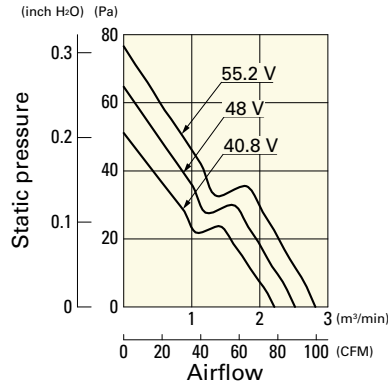

**9G1248F401** With pulse sensor

Operating voltage range

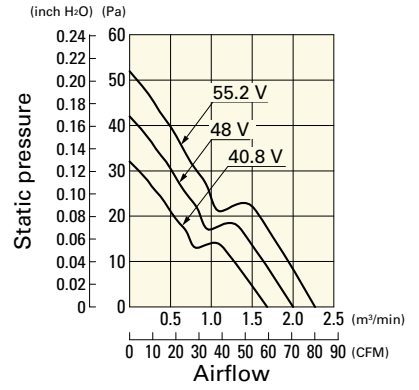

**9G1248M401** With pulse sensor

Operating voltage range

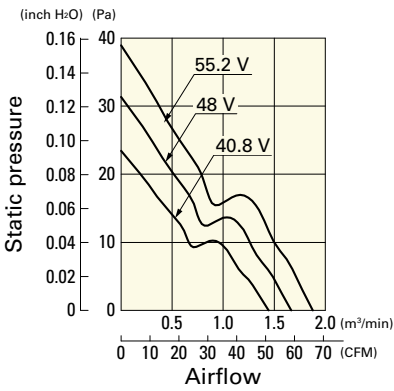

**Dimensions (unit: mm)** (With ribs)

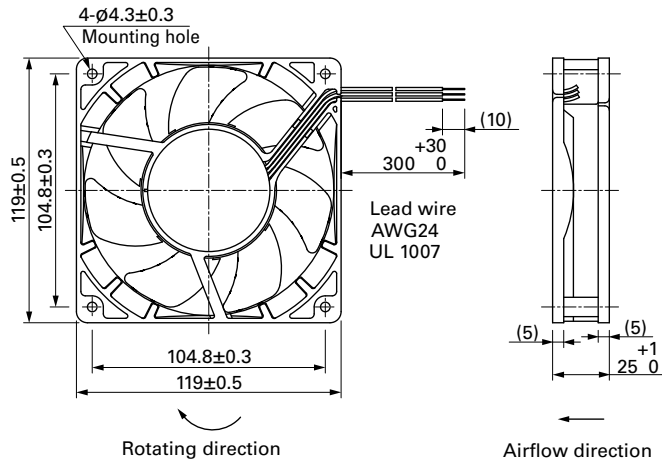

## Reference Dimensions of Mounting Holes and Vent Opening (unit: mm)

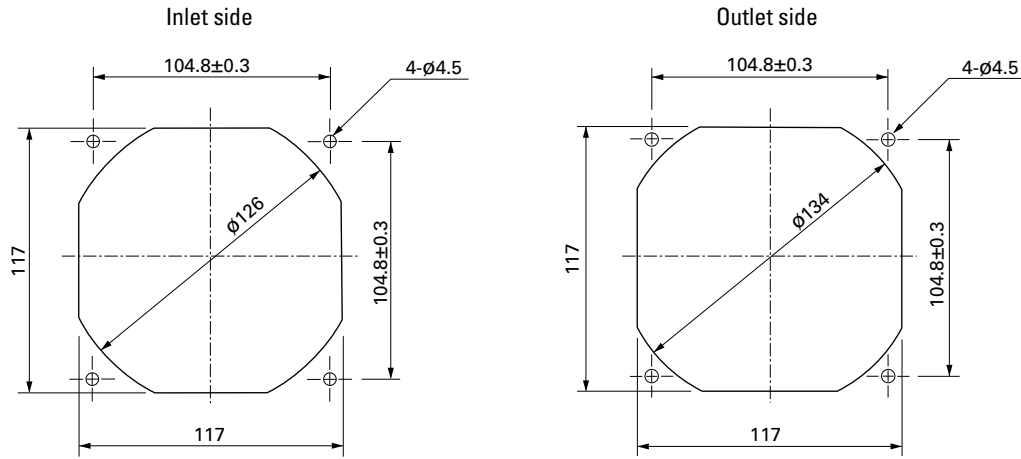

## Options

### Finger guards

page: p. 533

Model no.: 109-019E, 109-019K, 109-019C, 109-019H

### Resin finger guards

page: p. 539

Model no.: 109-1000G

### Resin filter kits

page: p. 540

Model no.: 109-1000F13 (13PPI), 109-1000F20 (20PPI),  
109-1000F30 (30PPI), 109-1000F40 (40PPI)



## Стандарт Электрон Связь

Мы молодая и активно развивающаяся компания в области поставок электронных компонентов. Мы поставляем электронные компоненты отечественного и импортного производства напрямую от производителей и с крупнейших складов мира.

Благодаря сотрудничеству с мировыми поставщиками мы осуществляем комплексные и плановые поставки широчайшего спектра электронных компонентов.

Собственная эффективная логистика и склад в обеспечивает надежную поставку продукции в точно указанные сроки по всей России.

Мы осуществляем техническую поддержку нашим клиентам и предпродажную проверку качества продукции. На все поставляемые продукты мы предоставляем гарантию .

Осуществляем поставки продукции под контролем ВП МО РФ на предприятия военно-промышленного комплекса России , а также работаем в рамках 275 ФЗ с открытием отдельных счетов в уполномоченном банке. Система менеджмента качества компании соответствует требованиям ГОСТ ISO 9001.

Минимальные сроки поставки, гибкие цены, неограниченный ассортимент и индивидуальный подход к клиентам являются основой для выстраивания долгосрочного и эффективного сотрудничества с предприятиями радиоэлектронной промышленности, предприятиями ВПК и научно-исследовательскими институтами России.

С нами вы становитесь еще успешнее!

### Наши контакты:

**Телефон:** +7 812 627 14 35

**Электронная почта:** [sales@st-electron.ru](mailto:sales@st-electron.ru)

**Адрес:** 198099, Санкт-Петербург,  
Промышленная ул, дом № 19, литера Н,  
помещение 100-Н Офис 331