

## Cree® XLamp® XQ-E LEDs

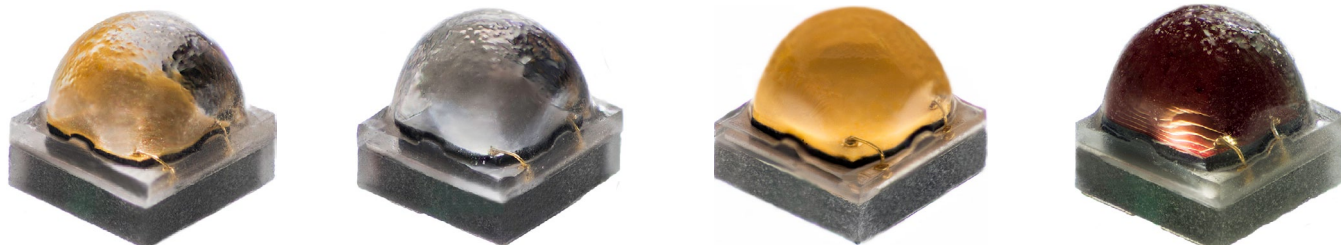

### PRODUCT DESCRIPTION

The XLamp® XQ-E LED family packs the lighting-class performance of the XP-E2 into a package that is 78 percent smaller. The compact XQ-E LED enables lighting manufacturers to significantly reduce the size and total cost of their LED luminaires, without sacrificing light output, efficacy or reliability.

The new XQ-E LEDs open up new design possibilities for a wide spectrum of lighting applications such as portable, indoor directional, architectural or vehicle lighting. The XQ-E's combination of consistent design across all configurations and its small size permit improved color mixing and optical control, compared to the larger XP-E2 LED.

### FEATURES

- Cree's smallest lighting class LED: 1.6 X 1.6 X 1.58 mm
- Available in 70- and 80-minimum CRI white, royal blue, blue, green, PC amber, red-orange & red
- 1 A maximum drive current
- Wide viewing angle: white 110°, royal blue, blue, green & PC amber, 125°, red-orange & red 130°
- Reflow solderable - JEDEC J-STD-020C compatible
- Unlimited floor life at ≤ 30 °C/85% RH
- RoHS- and REACH-compliant
- UL® recognized component (E349212)



### TABLE OF CONTENTS

Characteristics .....	2
Flux Characteristics - White.....	3
Flux Characteristics - Color .....	4
Relative Spectral Power Distribution .....	6
Relative Flux vs. Junction Temperature.....	7
Electrical Characteristics.....	8
Relative Flux vs. Current .....	9
Typical Spatial Distribution.....	11
Thermal Design .....	12
Reflow Soldering Characteristics.....	13
Notes .....	14
Mechanical Dimensions .....	16
Tape and Reel.....	17
Packaging.....	18

**CHARACTERISTICS**

Characteristics	Unit	Minimum	Typical	Maximum
Thermal resistance, junction to solder point - white, royal blue, blue	°C/W		6	
Thermal resistance, junction to solder point - green	°C/W		9	
Thermal resistance, junction to solder point - PC amber	°C/W		8	
Thermal resistance, junction to solder point - red-orange, red	°C/W		5	
Viewing angle (FWHM) - white	degrees		110	
Viewing angle (FWHM) - royal blue, blue, green, PC amber	degrees		125	
Viewing angle (FWHM) - red-orange, red	degrees		130	
Temperature coefficient of voltage - white	mV/°C		-2.3	
Temperature coefficient of voltage - royal blue, blue	mV/°C		-3.3	
Temperature coefficient of voltage - green	mV/°C		-3.8	
Temperature coefficient of voltage - PC amber	mV/°C		-3.3	
Temperature coefficient of voltage - red-orange, red	mV/°C		-1.8	
ESD withstand voltage (HBM per Mil-Std-883D)- white, royal blue, blue, green	V			8000
ESD classification (HBM per Mil-Std-883D) - PC amber, red-orange, red			Class 2	
DC forward current	mA			1000
Reverse voltage	V			5
Forward voltage (@ 350 mA, 85 °C) - white	V		2.9	3.25
Forward voltage (@ 350 mA, 25 °C) - royal blue, blue	V		3.1	3.5
Forward voltage (@ 350 mA, 25 °C) - green	V		3.2	3.6
Forward voltage (@ 350 mA, 25 °C) - PC amber	V		3.1	3.5
Forward voltage (@ 350 mA, 25 °C) - red-orange, red	V		2.2	2.6
LED junction temperature	°C			150

## FLUX CHARACTERISTICS - WHITE ( $T_j = 85\text{ }^\circ\text{C}$ )

The following table provides several base order codes for XLamp XQ-E white LEDs. It is important to note that the base order codes listed here are a subset of the total available order codes for the product family. For more order codes, as well as a complete description of the order-code nomenclature, please consult the XLamp XQ Family LEDs Binning and Labeling document.

Color	CCT Range		Minimum Luminous Flux (lm) @ 350 mA			Calculated Minimum Luminous Flux (lm)** @ 85 °C		Order Code
	Min.	Max.	Group	Flux (lm) @ 85 °C	Flux (lm) @ 25 °C*	700 mA	1.0 A	
Cool White	5000 K	8300 K	R3	122	142	244	314	XQEAWT-00-0000-00000LFE1
			R2	114	132	196	252	XQEAWT-00-0000-00000LEE1
			Q5	107	124	184	237	XQEAWT-00-0000-00000LDE1
70-CRI White	3700 K	8300 K	R3	122	142	244	314	XQEAWT-00-0000-00000BFE1
			R2	114	132	196	252	XQEAWT-00-0000-00000BEE1
			Q5	107	124	184	237	XQEAWT-00-0000-00000BDE1
Neutral White	3700 K	5300 K	R2	114	132	196	252	XQEAWT-00-0000-00000LEE4
			Q5	107	124	186	236	XQEAWT-00-0000-00000LDE4
			Q4	100	116	172	221	XQEAWT-00-0000-00000LCE4
80-CRI White	2700 K	3500 K	Q4	100	116	172	221	XQEAWT-00-0000-00000HCE7
			Q3	93.9	111	162	208	XQEAWT-00-0000-00000HBE7
			Q2	87.4	101	150	193	XQEAWT-00-0000-00000HAE7
Warm White	2700 K	3500 K	Q4	100	116	172	221	XQEAWT-00-0000-00000LCE7
			Q3	93.9	111	162	208	XQEAWT-00-0000-00000LBE7
			Q2	87.4	101	150	193	XQEAWT-00-0000-00000LAE7

### Notes:

- Cree maintains a tolerance of  $\pm 7\%$  on flux and power measurements,  $\pm 0.005$  on chromaticity (CCx, CCy) measurements and  $\pm 2$  on CRI measurements. See the Measurements section (page 14).
- Typical CRI for Cool White (5000 K – 8300 K CCT) is 70.
- Typical CRI for Neutral White (3700 K – 5300 K CCT) is 75.
- Typical CRI for Warm White (2700 K – 3500 K CCT) is 80.
- Minimum CRI for 70-CRI White is 70.
- Minimum CRI for 80-CRI White is 80.
- \* Flux values @ 25 °C are calculated and for reference only.
- \*\* Calculated flux values at 700 mA and 1 A are for reference only.

## FLUX CHARACTERISTICS - COLOR ( $T_j = 25\text{ }^\circ\text{C}$ )

The following table provides several base order codes for XLamp XQ-E color LEDs. It is important to note that the base order codes listed here are a subset of the total available order codes for the product family. For more order codes, as well as a complete description of the order-code nomenclature, please consult the XLamp XQ Family LEDs Binning and Labeling document.

Color	Dominant Wavelength Range				Minimum Radiant Flux (mW) @ 350 mA		Order Code
	Min.		Max.		Group	Flux (mW)	
	Group	DWL (nm)	Group	DWL (nm)			
Royal Blue	D36	450	D57	465	35 (P)	575	XQEROY-00-0000-000000P01
					34 (N)	550	XQEROY-00-0000-000000N01
					33 (M)	525	XQEROY-00-0000-000000M01
					32 (L)	500	XQEROY-00-0000-000000L01
					31 (K)	475	XQEROY-00-0000-000000K01
					30 (J)	450	XQEROY-00-0000-000000J01

Color	Dominant Wavelength Range				Minimum Luminous Flux (lm) @ 350 mA		Order Code
	Min.		Max.		Group	Flux (lm)	
	Group	DWL (nm)	Group	DWL (nm)			
Blue	B3	465	B6	485	M3	45.7	XQEBLU-00-0000-000000301
					M2	39.8	XQEBLU-00-0000-000000201
					K3	35.2	XQEBLU-00-0000-000000Z01
					K2	30.6	XQEBLU-00-0000-000000Y01

Color	Dominant Wavelength Range				Minimum Luminous Flux (lm) @ 350 mA		Order Code
	Min.		Max.		Group	Flux (lm)	
	Group	DWL (nm)	Group	DWL (nm)			
Green	G2	520	G4	535	R2	114	XQEGRN-00-0000-000000E01
					Q5	107	XQEGRN-00-0000-000000D01
					Q4	100	XQEGRN-00-0000-000000C01
					Q3	93.9	XQEGRN-00-0000-000000B01

### Note

- Cree maintains a tolerance of  $\pm 7\%$  on flux and power measurements,  $\pm 0.005$  on chromaticity (CCx, CCy) measurements and a tolerance of  $\pm 2$  on CRI measurements. See the Measurements section (page 14).

**FLUX CHARACTERISTICS - COLOR (T<sub>j</sub> = 25 °C) - CONTINUED**

Color	Color Bin	Minimum Luminous Flux (lm) @ 350 mA		Order Code
		Group	Flux (lm) @ 25 °C*	
PC Amber	Y2	P4	80.6	XQEAPA-00-0000-000000901
		P3	73.9	XQEAPA-00-0000-000000801

Color	Dominant Wavelength Range				Minimum Luminous Flux (lm) @ 350 mA		Order Code
	Min.		Max.		Group	Flux (lm)	
	Group	DWL (nm)	Group	DWL (nm)			
Red-Orange	O3	610	O4	620	Q3	93.9	XQERDO-00-0000-000000B01
					Q2	87.4	XQERDO-00-0000-000000A01
					P4	80.6	XQERDO-00-0000-000000901
					P3	73.9	XQERDO-00-0000-000000801
					P2	67.2	XQERDO-00-0000-000000701

Color	Dominant Wavelength Range				Minimum Luminous Flux (lm) @ 350 mA		Order Code
	Min.		Max.		Group	Flux (lm)	
	Group	DWL (nm)	Group	DWL (nm)			
Red	R2	620	R3	630	P3	73.9	XQERED-00-0000-000000801
					P2	67.2	XQERED-00-0000-000000701
					N4	62	XQERED-00-0000-000000601
					N3	56.8	XQERED-00-0000-000000501

- Note**
- Cree maintains a tolerance of ±7% on flux and power measurements, ±0.005 on chromaticity (CCx, CCy) measurements and a tolerance of ±2 on CRI measurements. See the Measurements section (page 14).

**RELATIVE SPECTRAL POWER DISTRIBUTION**

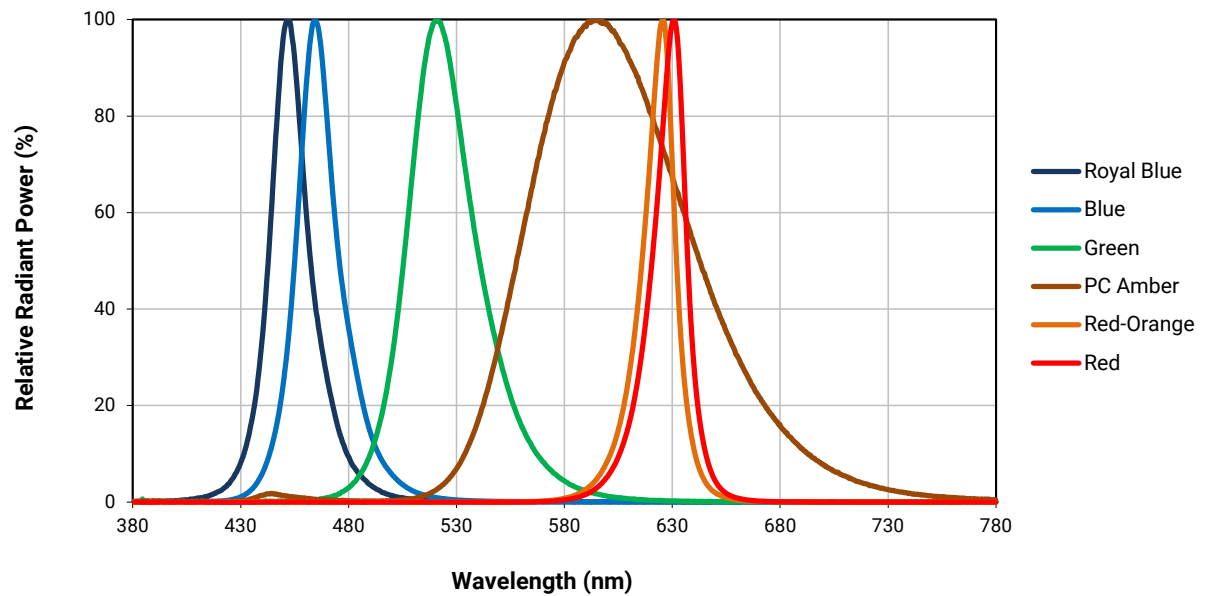
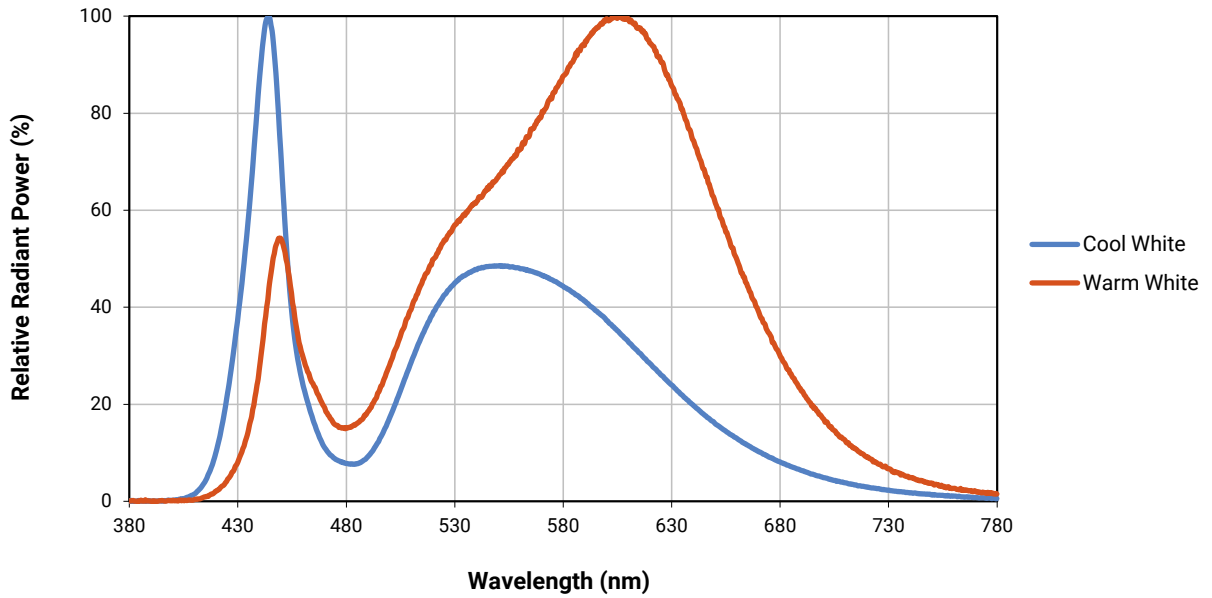

**RELATIVE FLUX VS. JUNCTION TEMPERATURE ( $I_F = 350$  mA)**

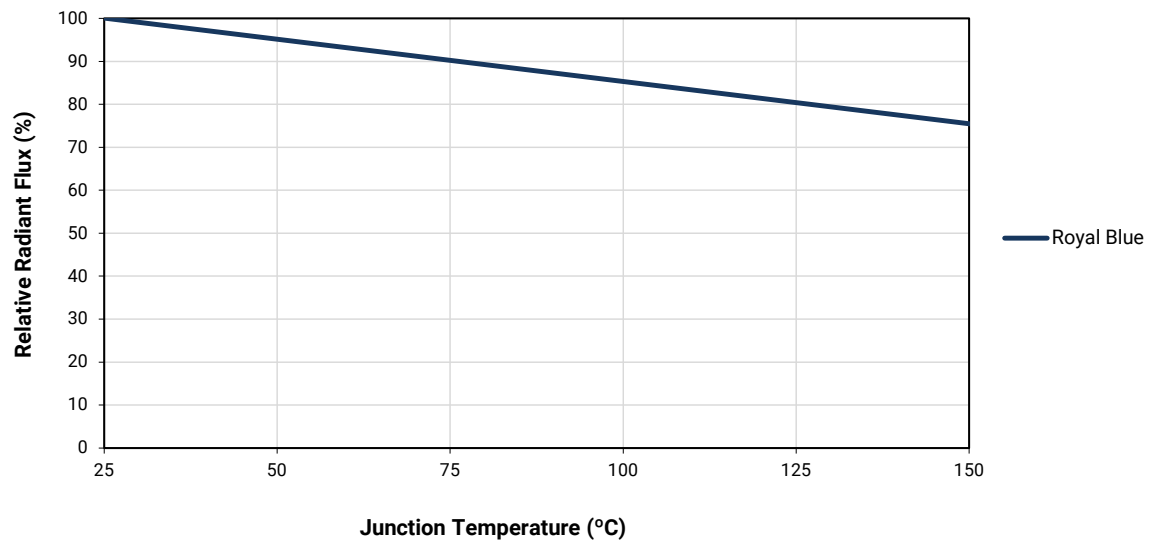
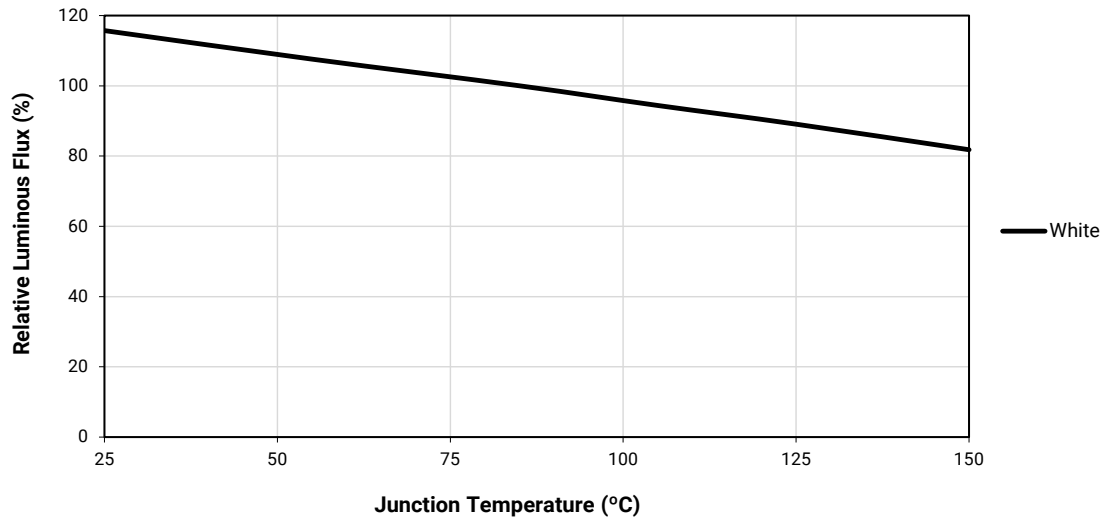

**RELATIVE FLUX VS. JUNCTION TEMPERATURE ( $I_F = 350 \text{ mA}$ ) - CONTINUED**

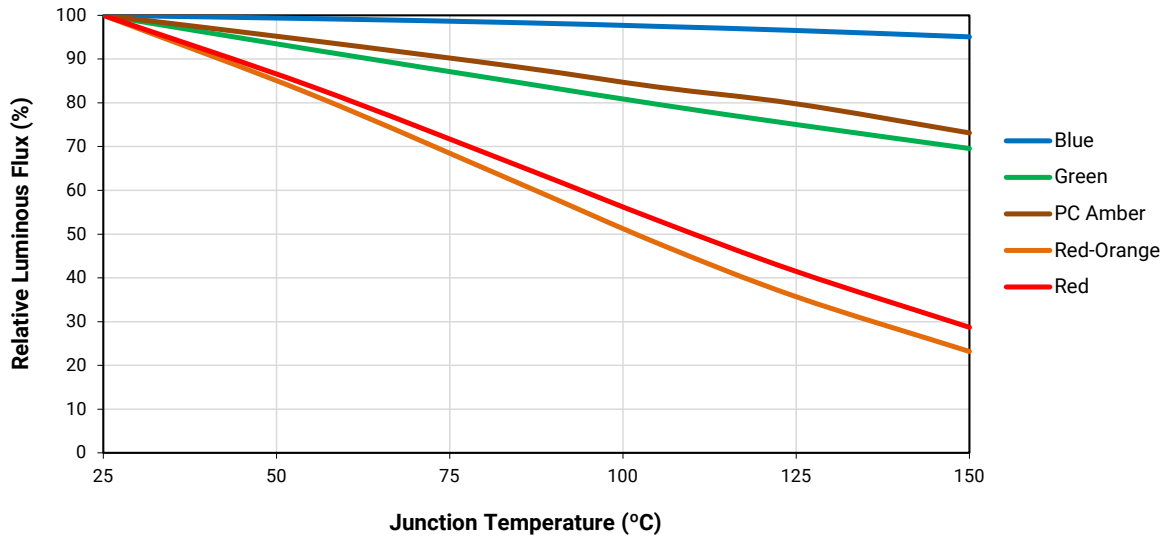

**ELECTRICAL CHARACTERISTICS ( $T_J = 85 \text{ °C}$ )**

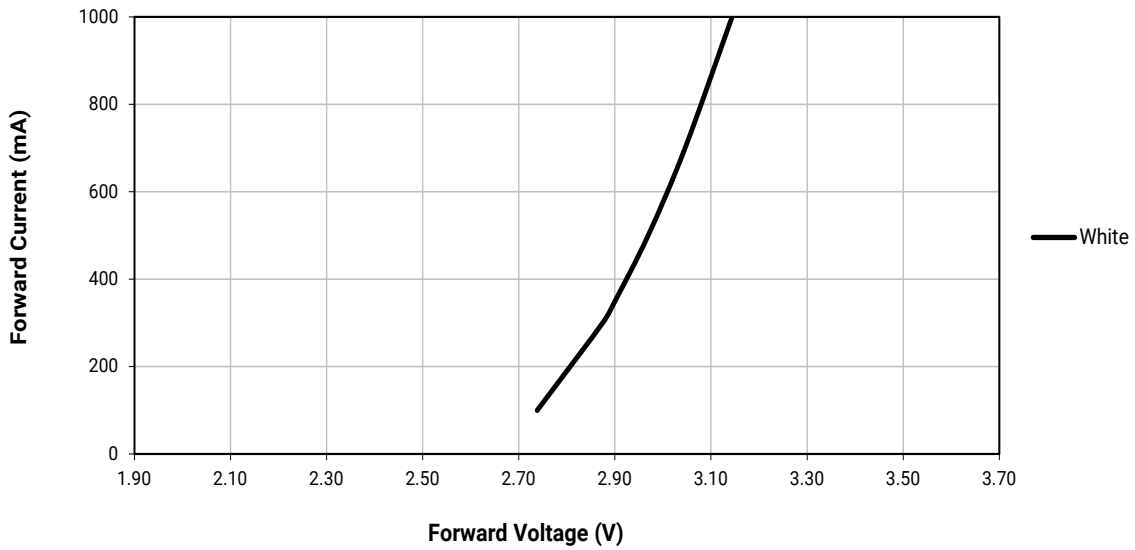



**ELECTRICAL CHARACTERISTICS ( $T_j = 25\text{ }^\circ\text{C}$ ) - CONTINUED**

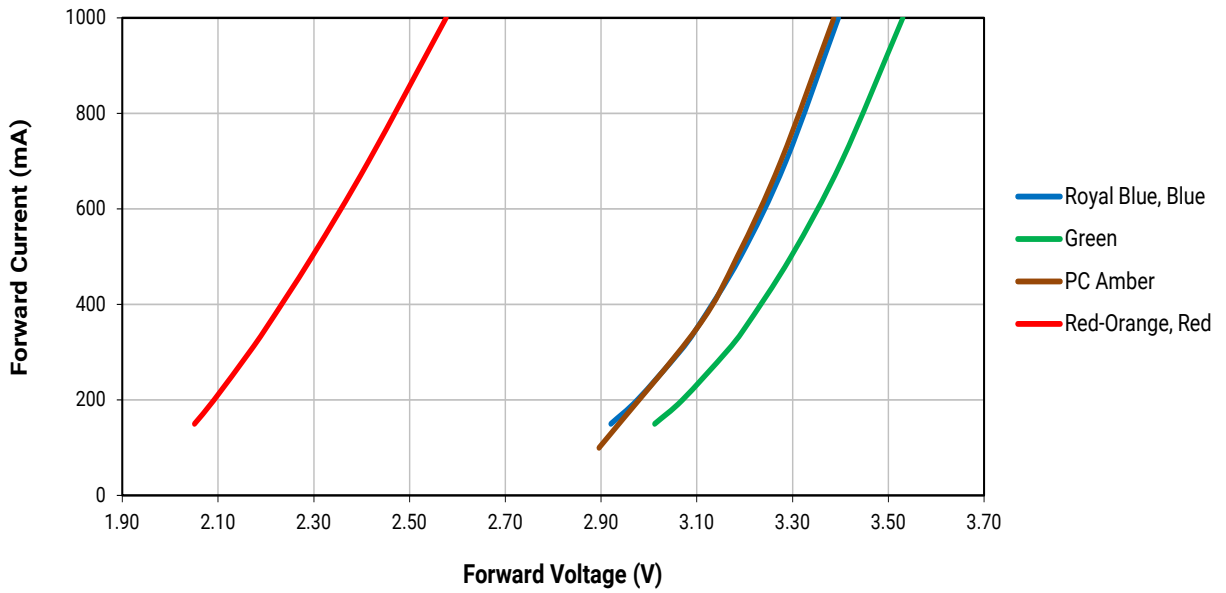

**RELATIVE FLUX VS. CURRENT ( $T_j = 85\text{ }^\circ\text{C}$ )**

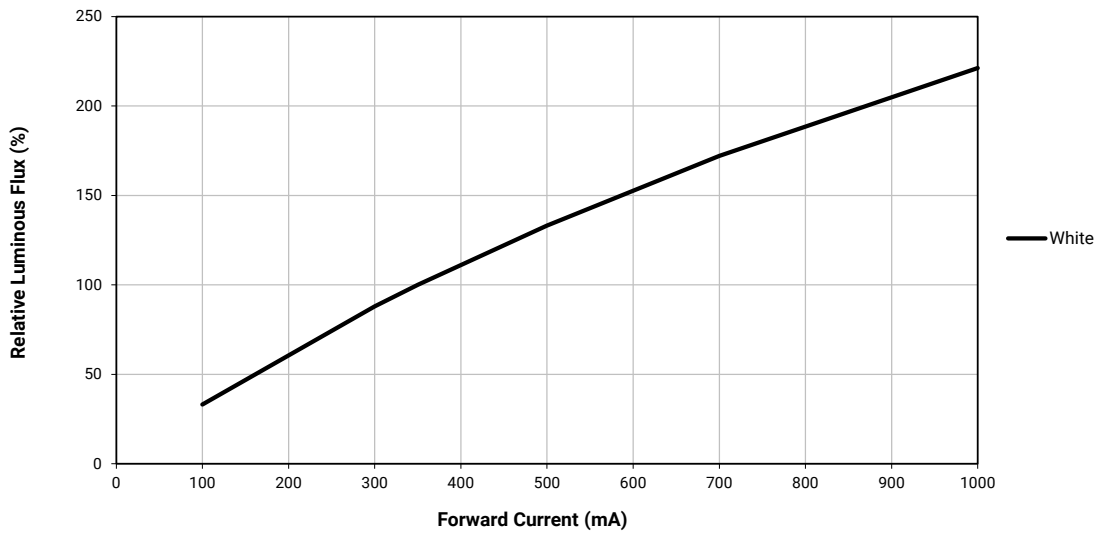

**RELATIVE FLUX VS. CURRENT ( $T_j = 25\text{ }^\circ\text{C}$ ) - CONTINUED**

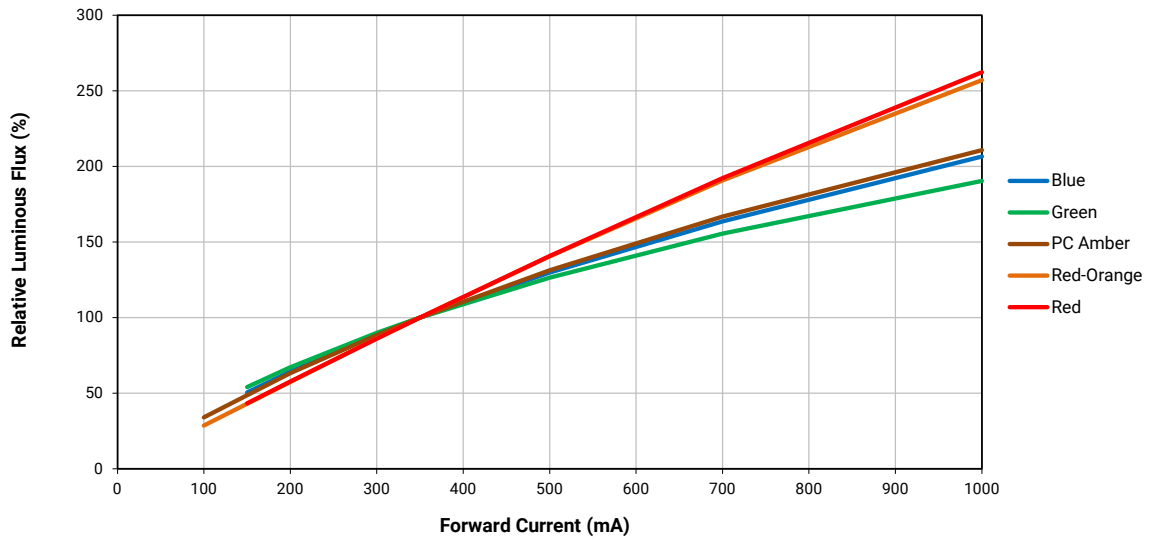
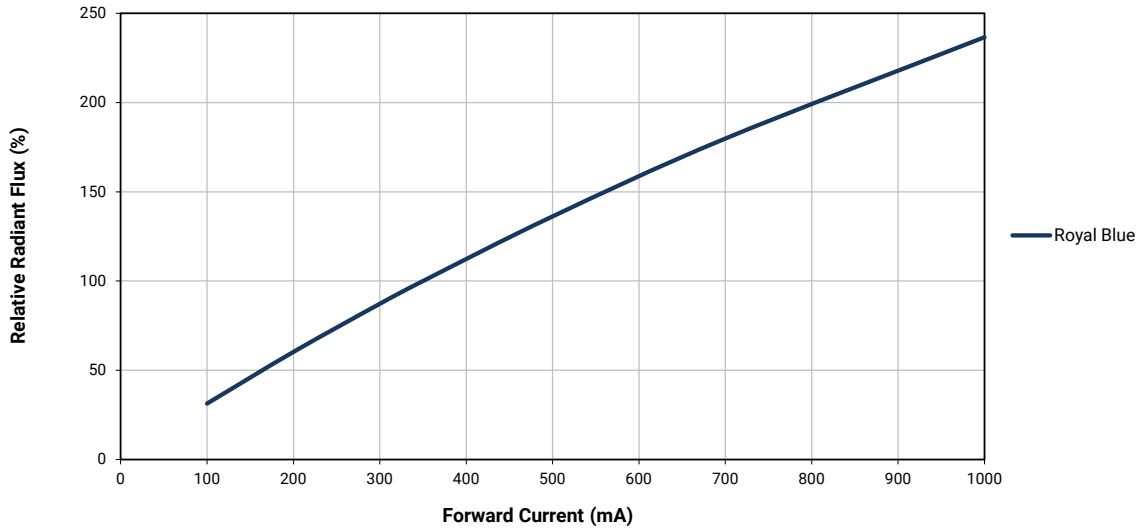

**TYPICAL SPATIAL DISTRIBUTION**

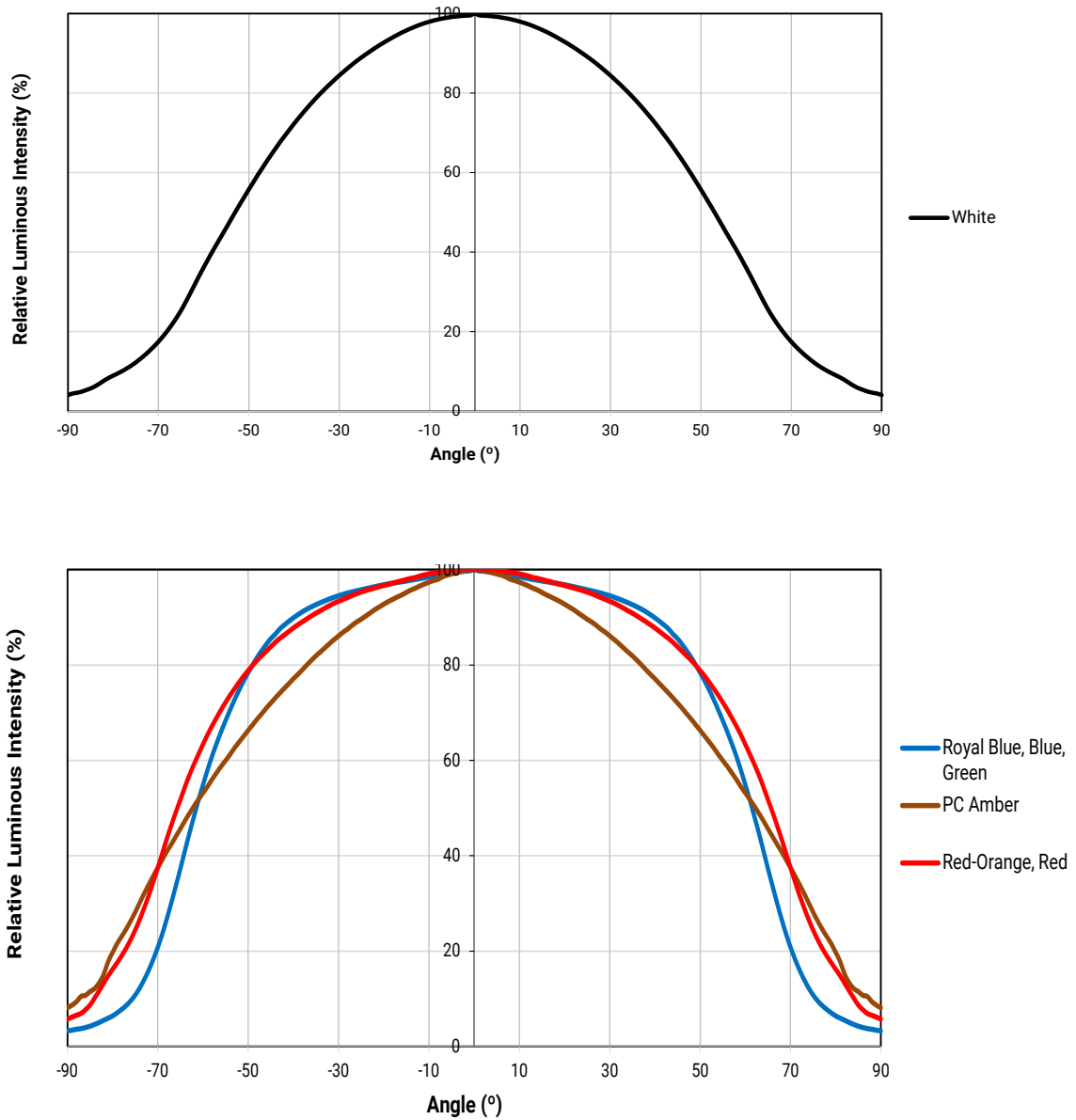

**THERMAL DESIGN**

The maximum forward current is determined by the thermal resistance between the LED junction and ambient. It is crucial for the end product to be designed in a manner that minimizes the thermal resistance from the solder point to ambient in order to optimize lamp life and optical characteristics.

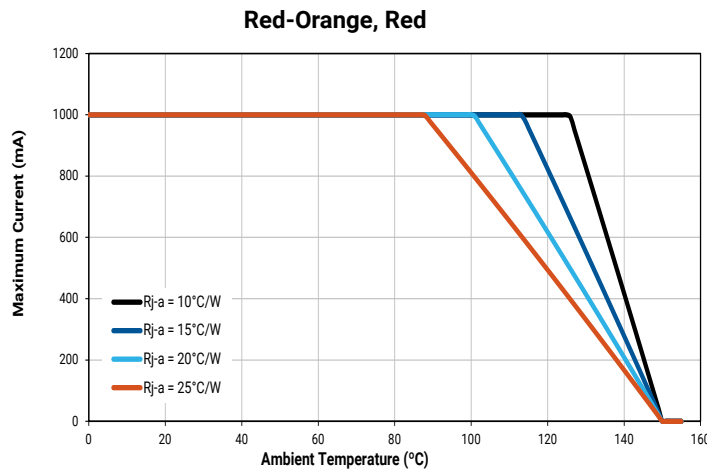
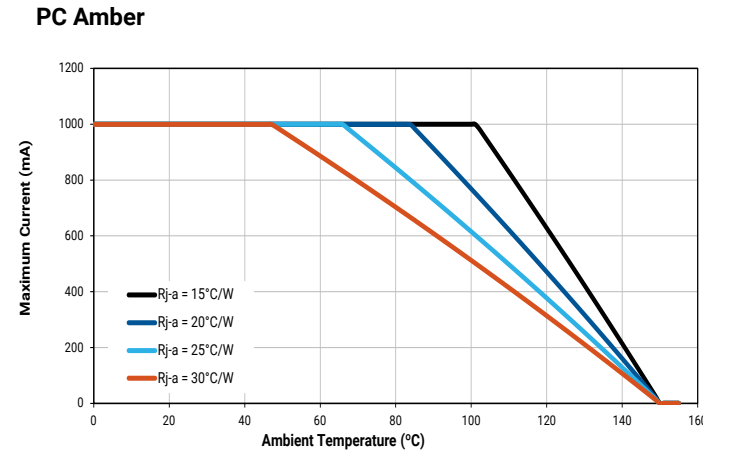
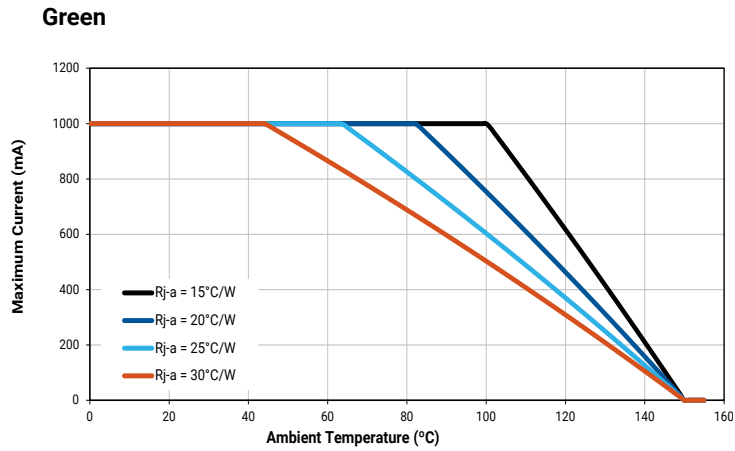
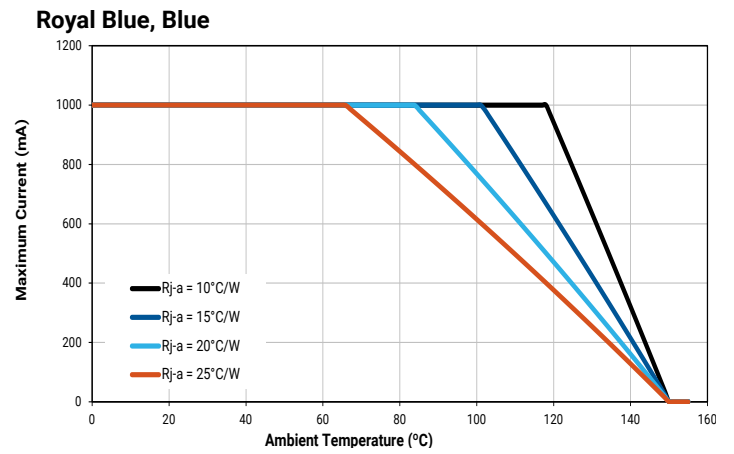
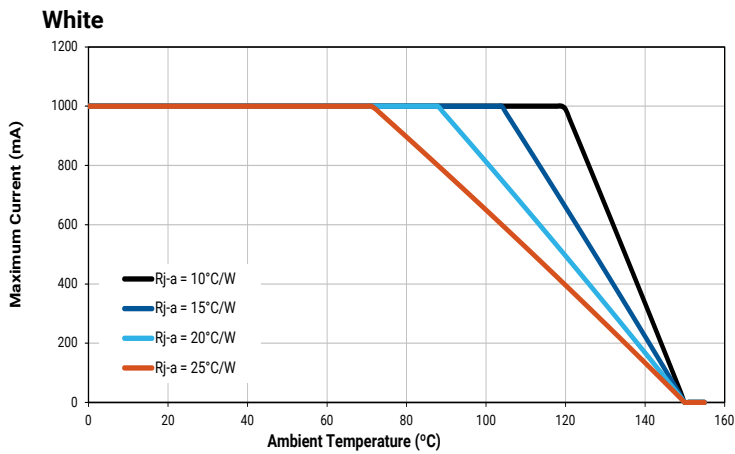

**REFLOW SOLDERING CHARACTERISTICS**

In testing, Cree has found XLamp XQ-E LEDs to be compatible with JEDEC J-STD-020C, using the parameters listed below. As a general guideline, Cree recommends that users follow the recommended soldering profile provided by the manufacturer of the solder paste used.

Note that this general guideline may not apply to all PCB designs and configurations of reflow soldering equipment.

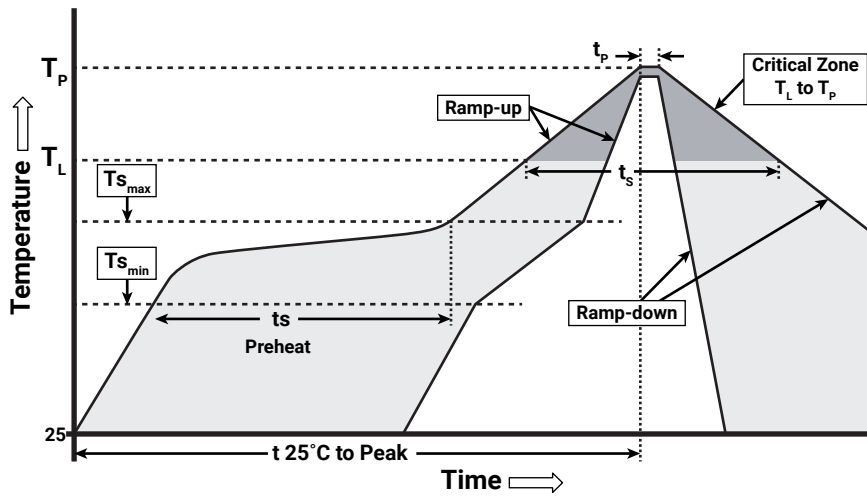

IPC/JEDEC J-STD-020C

Profile Feature	Lead-Based Solder	Lead-Free Solder
Average Ramp-Up Rate ( $T_{s_{max}}$ to $T_p$ )	3 °C/second max.	3 °C/second max.
Preheat: Temperature Min ( $T_{s_{min}}$ )	100 °C	150 °C
Preheat: Temperature Max ( $T_{s_{max}}$ )	150 °C	200 °C
Preheat: Time ( $t_{s_{min}}$ to $t_{s_{max}}$ )	60-120 seconds	60-180 seconds
Time Maintained Above: Temperature ( $T_L$ )	183 °C	217 °C
Time Maintained Above: Time ( $t_L$ )	60-150 seconds	60-150 seconds
Peak/Classification Temperature ( $T_p$ )	215 °C	260 °C
Time Within 5 °C of Actual Peak Temperature ( $t_p$ )	10-30 seconds	20-40 seconds
Ramp-Down Rate	6 °C/second max.	6 °C/second max.
Time 25 °C to Peak Temperature	6 minutes max.	8 minutes max.

Note: All temperatures refer to topside of the package, measured on the package body surface.

## NOTES

---

### Measurements

The luminous flux, radiant power, chromaticity and CRI measurements in this document are binning specifications only and solely represent product measurements as of the date of shipment. These measurements will change over time based on a number of factors that are not within Cree's control and are not intended or provided as operational specifications for the products. Calculated values are provided for informational purposes only and are not intended as specifications.

### Lumen Maintenance

Cree now uses standardized IES LM-80-08 and TM-21-11 methods for collecting long-term data and extrapolating LED lumen maintenance. For information on the specific LM-80 data sets available for this LED, refer to the public [LM-80 results document](#).

Please read the [Long-Term Lumen Maintenance application note](#) for more details on Cree's lumen maintenance testing and forecasting. Please read the [Thermal Management application note](#) for details on how thermal design, ambient temperature, and drive current affect the LED junction temperature.

### Moisture Sensitivity

Cree recommends keeping XLamp LEDs in the provided, resealable moisture-barrier packaging (MBP) until immediately prior to soldering. Unopened MBPs that contain XLamp LEDs do not need special storage for moisture sensitivity.

Once the MBP is opened, XLamp XQ-E LEDs may be stored as MSL 1 per JEDEC J-STD-033, meaning they have unlimited floor life in conditions of  $\leq 30$  °C/85% relative humidity (RH). Regardless of storage condition, Cree recommends sealing any unsoldered LEDs in the original MBP.

### RoHS Compliance

The levels of RoHS restricted materials in this product are below the maximum concentration values (also referred to as the threshold limits) permitted for such substances, or are used in an exempted application, in accordance with EU Directive 2011/65/EC (RoHS2), as implemented January 2, 2013. RoHS Declarations for this product can be obtained from your Cree representative or from the Product Documentation sections of [www.cree.com](http://www.cree.com).

### REACH Compliance

REACH substances of very high concern (SVHCs) information is available for this product. Since the European Chemical Agency (ECHA) has published notice of their intent to frequently revise the SVHC listing for the foreseeable future, please contact a Cree representative to insure you get the most up-to-date REACH SVHC Declaration. REACH banned substance information (REACH Article 67) is also available upon request.

### UL® Recognized Component

Level 1 enclosure consideration. The LED package or a portion thereof has not been investigated as a fire enclosure or a fire and electrical enclosure per ANSI/UL 8750.

**NOTES - CONTINUED**

---

**Vision Advisory**

WARNING: Do not look at an exposed lamp in operation. Eye injury can result. For more information about LEDs and eye safety, please refer to the [LED Eye Safety application note](#).

**MECHANICAL DIMENSIONS**

All dimensions in mm.

Measurement tolerances unless indicated otherwise: .xx = ±.25 mm, .xxx = ±.125 mm

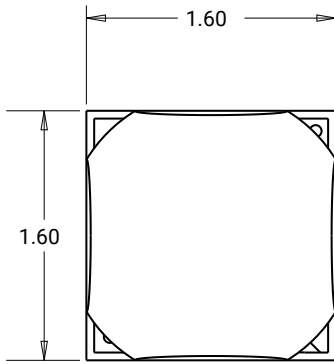

**Top View**

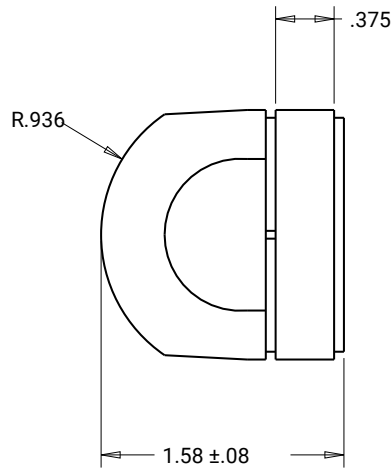

**Side View**

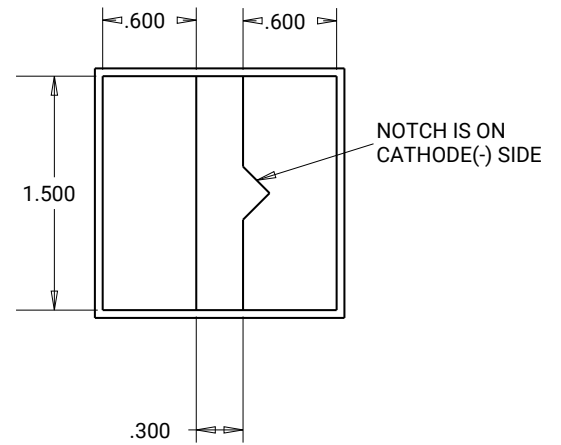

**Bottom View**

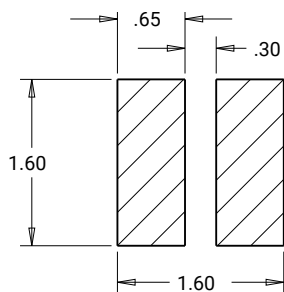

**Recommended PCB solder pad**

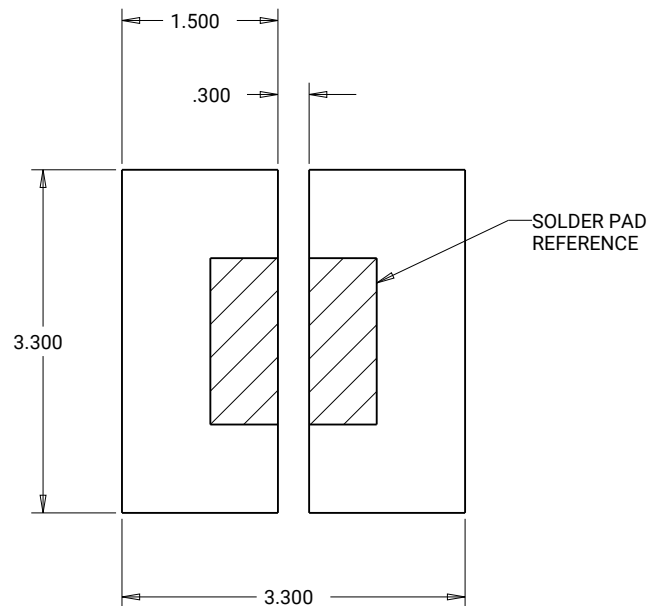

**Recommended trace layout**



**TAPE AND REEL**

All Cree carrier tapes conform to EIA-481D, Automated Component Handling Systems Standard.

All dimensions in mm.

Measurement tolerances unless indicated otherwise: .xx = ±.25 mm, .xxx = . ± 125 mm

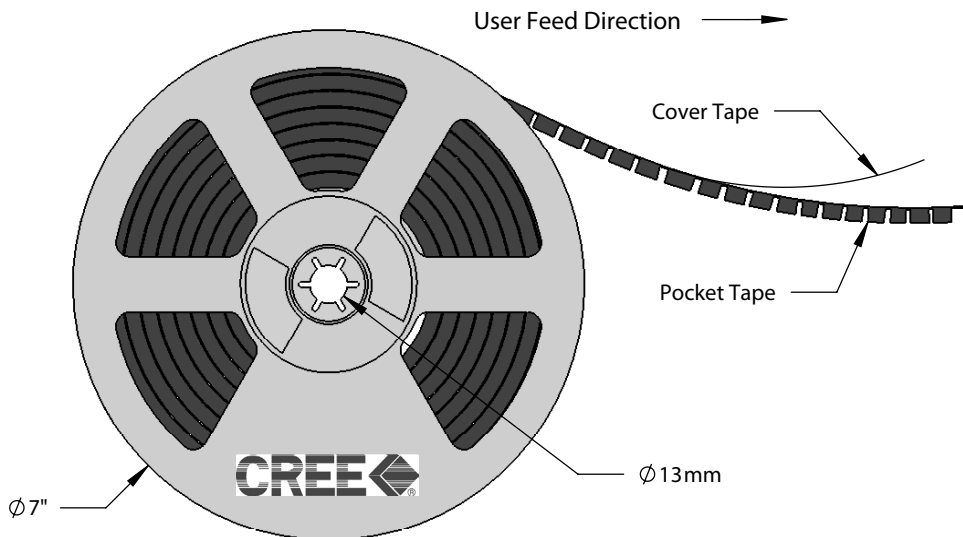
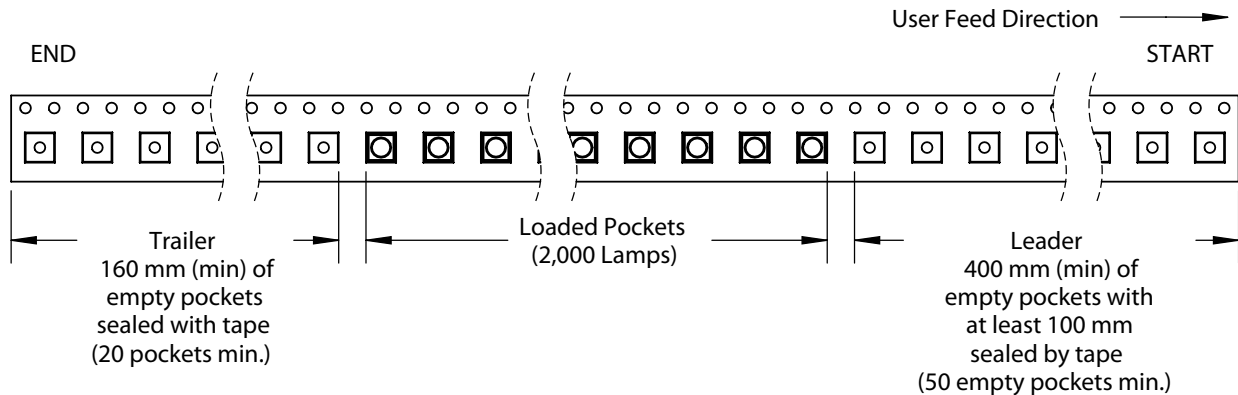
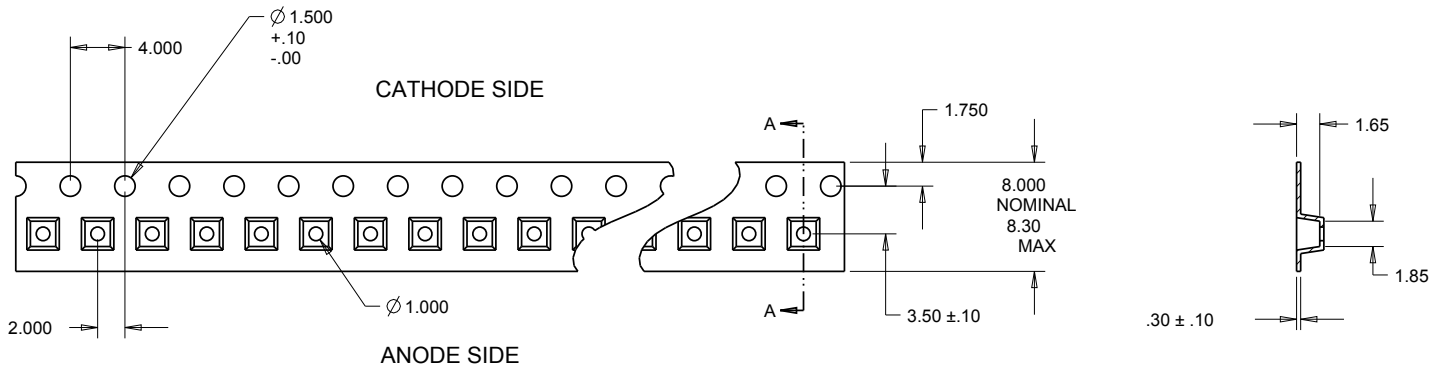

**PACKAGING**

The diagrams below show the packaging and labels Cree uses to ship XLamp XQ-E LEDs. XLamp XQ-E LEDs are shipped in tape loaded on a reel. Each box contains only one reel in a moisture barrier bag.

**Unpackaged Reel**

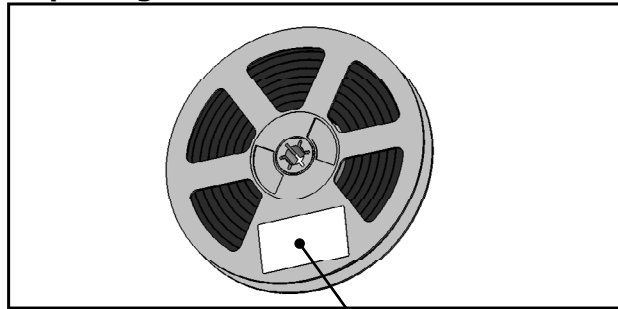

Label with Cree Bin Code, Quantity, Reel ID

**Packaged Reel**

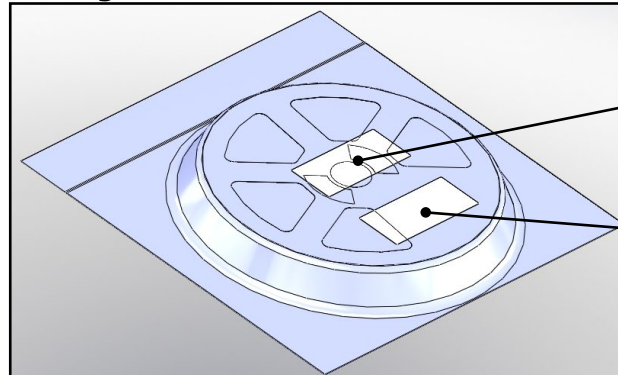

Label with Cree Order Code, Quantity, Reel ID, PO #

Label with Cree Bin Code, Quantity, Reel ID

**Boxed Reel**

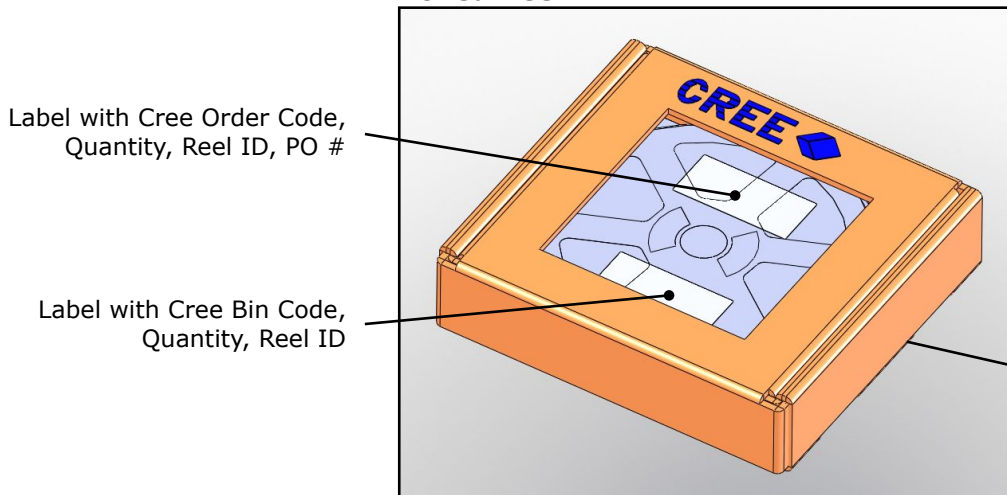

Label with Cree Order Code, Quantity, Reel ID, PO #

Label with Cree Bin Code, Quantity, Reel ID

Patent Label (on bottom of box)



**Стандарт  
Электрон  
Связь**

Мы молодая и активно развивающаяся компания в области поставок электронных компонентов. Мы поставляем электронные компоненты отечественного и импортного производства напрямую от производителей и с крупнейших складов мира.

Благодаря сотрудничеству с мировыми поставщиками мы осуществляем комплексные и плановые поставки широчайшего спектра электронных компонентов.

Собственная эффективная логистика и склад в обеспечивает надежную поставку продукции в точно указанные сроки по всей России.

Мы осуществляем техническую поддержку нашим клиентам и предпродажную проверку качества продукции. На все поставляемые продукты мы предоставляем гарантию .

Осуществляем поставки продукции под контролем ВП МО РФ на предприятия военно-промышленного комплекса России , а также работаем в рамках 275 ФЗ с открытием отдельных счетов в уполномоченном банке. Система менеджмента качества компании соответствует требованиям ГОСТ ISO 9001.

Минимальные сроки поставки, гибкие цены, неограниченный ассортимент и индивидуальный подход к клиентам являются основой для выстраивания долгосрочного и эффективного сотрудничества с предприятиями радиоэлектронной промышленности, предприятиями ВПК и научно-исследовательскими институтами России.

С нами вы становитесь еще успешнее!

**Наши контакты:**

**Телефон:** +7 812 627 14 35

**Электронная почта:** [sales@st-electron.ru](mailto:sales@st-electron.ru)

**Адрес:** 198099, Санкт-Петербург,  
Промышленная ул, дом № 19, литера Н,  
помещение 100-Н Офис 331