

1-channel Switching Gate Driver

■ GENERAL DESCRIPTION

The NJW4841 is a High Speed Switching Gate Driver that is applicable 2A peak current.

The NJW4841 features are Withstand voltage of 40V, recommended operating voltage range: 4V to 20V and Fast switching time

The NJW4841 is suitable for DC / AC Motor Drive, Switching Power Supply and DC / DC Converter Applications.

■ PACKAGE OUTLINE

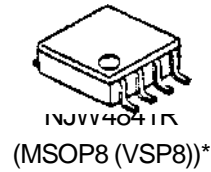

■ FEATURES

- Output Peak Current: $\pm 2A$ (peak)
- Operating Voltage Range: 4V to 20V
- High Speed Switching: $t_r/t_f=25ns/20ns$ (typ.) at $C_L=2200pF$
- Corresponding with Logic Voltage Operation: 3V/5V
- Built-in Thermal Shut Down
- Under Voltage Lockout
- Package: MSOP8 (VSP8)*

* MEET JEDEC MO-187-DA

■ PIN CONFIGURATION

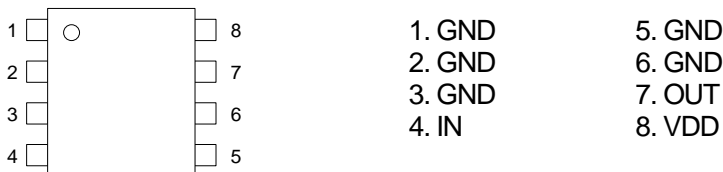

■ BLOCK DIAGRAM

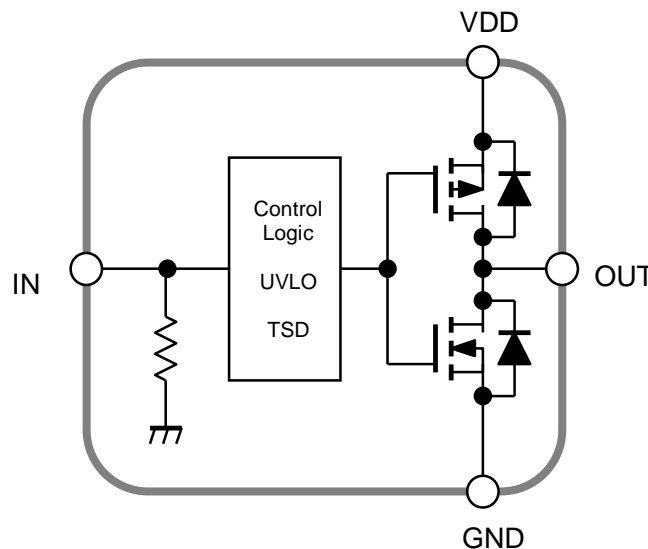

NJW4841

■ ABSOLUTE MAXIMUM RATINGS

(Ta=25°C)

PARAMETER	SYMBOL	RATINGS	UNIT	REMARK
Supply Voltage	V _{DD}	+40	V	VDD-GND Pin
Input Voltage	V _{IN}	-0.3 to +6	V	IN-GND Pin
Power Dissipation	P _D	720 (*1) 1100 (*2)	mW	-
Junction Temperature	T _j	-40 to +150	°C	-
Operating Temperature	T _{opr}	-40 to +85	°C	-
Storage Temperature	T _{stg}	-50 to +150	°C	-

(*1): Mounted on glass epoxy board. (76.2×114.3×1.6mm: based on EIA/JDEC standard, 2Layers)

(*2): Mounted on glass epoxy board. (76.2×114.3×1.6mm: based on EIA/JDEC standard, 4Layers),

internal Cu area: 74.2×74.2mm

■ RECOMMENDED OPERATING CONDITIONS

(Ta=25°C)

PARAMETER	SYMBOL	MIN.	TYP.	MAX.	UNIT	REMARK
Operating Voltage	V _{DD}	4.0	-	20	V	VDD-GND Pin
Input Voltage	V _{IN}	0	-	5.5	V	IN-GND Pin

■ ELECTRICAL CHARACTERISTICS

(Unless otherwise noted, $V_{DD}=16V$, $T_a=25^\circ C$)

PARAMETER	SYMBOL	TEST CONDITIONS	MIN.	TYP.	MAX.	UNIT
General						
Quiescent Current	I_{Q1}	$V_{IN}=5V$	–	1.5	2.5	mA
	I_{Q2}	$V_{IN}=0V$	–	1.3	2.3	mA
Output Block						
Output Peak Current	I_{PK1}	Pulse Width $\leq 10\mu s$, $V_{OUT}=0V$	–	2	–	A
	I_{PK2}	Pulse Width $\leq 10\mu s$, $V_{OUT}=16V$	–	2	–	A
Output ON Resistance (High-Side / Low-Side)	R_{DSH}	$I_{O-SOURCE}=100mA$	–	2.1	3.9	Ω
	R_{DSL}	$I_{O-SINK}=100mA$	–	1.5	2.8	Ω
Output Pull Down Resistance	R_{OUTPD}		60	100	140	k Ω
Input Circuit Block						
IN Pin High Voltage	V_{IHIN}		2.0	–	5.5	V
IN Pin Low Voltage	V_{ILIN}		0	–	0.8	V
Input Pull Down Resistance	R_{INPD}		60	100	140	k Ω
UVLO Block						
UVLO Release Voltage	V_{UVLO2}		2.8	3.3	3.8	V
UVLO Operating Voltage	V_{UVLO1}		2.5	3.0	3.5	V
UVLO Hysteresis Voltage	V_{UVLO}	$V_{UVLO2} - V_{UVLO1}$	–	0.3	–	V
Output Rise/Fall characteristics						
Output Rise Time	t_r	$C_L=2200pF$, $V_{IN}=0$ to $5V$	–	25	–	ns
Output Fall Time	t_f	$C_L=2200pF$, $V_{IN}=5$ to $0V$	–	20	–	ns
Rise Delay Time	$t_{d ON}$	$C_L=2200pF$, $V_{IN}=0$ to $5V$	–	40	–	ns
Fall Delay Time	$t_{d OFF}$	$C_L=2200pF$, $V_{IN}=5$ to $0V$	–	45	–	ns

NJW4841

■ TIMING CHART

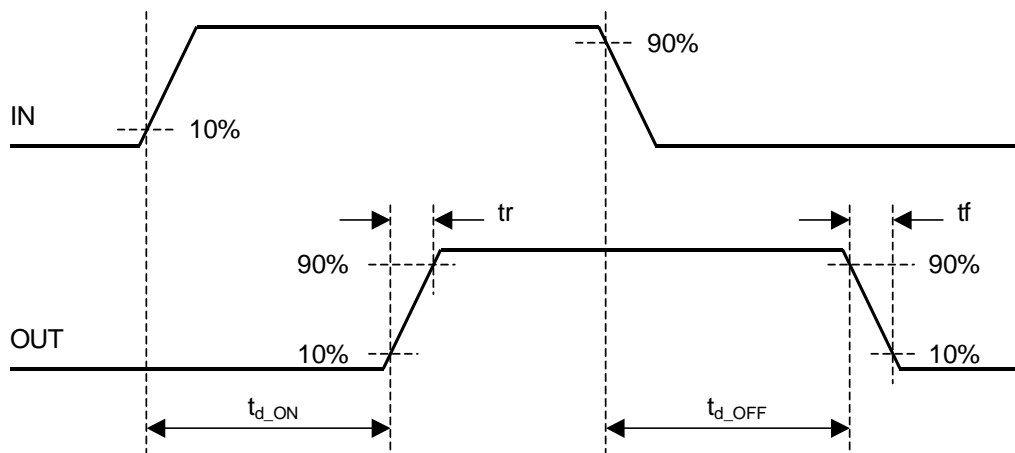

■ TYPICAL APPLICATION

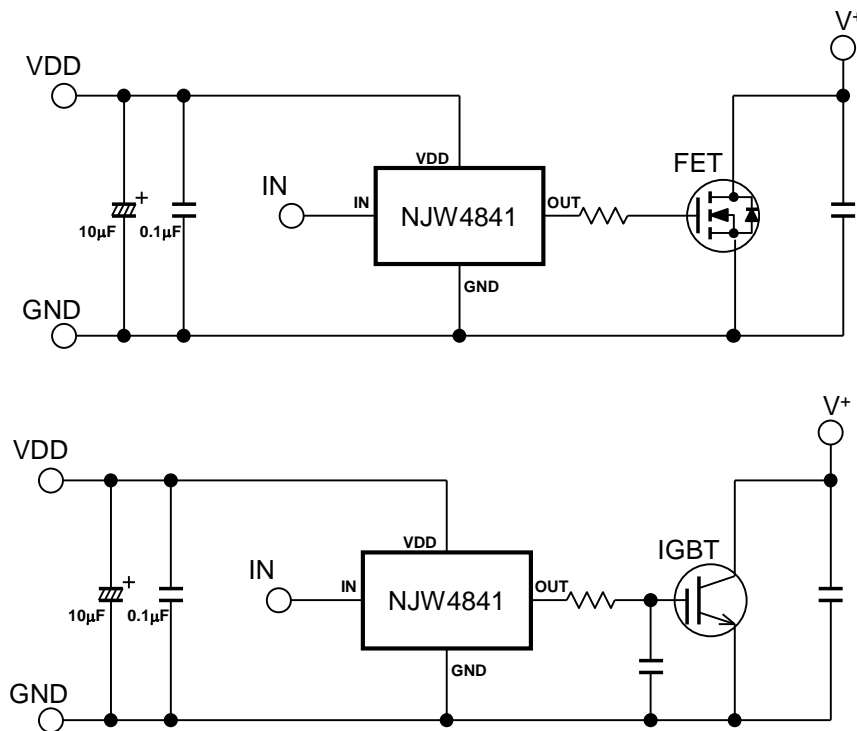

■ APPLICATION TIPS

In the application that does a high-speed switching of NJW4841, because the current flow corresponds to the input frequency, the substrate (PCB) layout becomes an important.

NJW4841 is driving the High-side/Low-side SW gate with high speed to reduce switching losses. The transient voltage is generated by parasitic inductance and a high-speed current change of high side and low side SW.

You should attempt the transient voltage decrease by making a current loop area minimize as much as possible. Therefore, you should make a current flowing line thick and short as much as possible.

You should insert a bypass capacitor between the VDD pin and the GND pin to prevent malfunction by transient voltage and/or exceed maximum input voltage rating. The recommended bypass capacitor is low ESR and fine high frequency characteristic (NJRC recommends 0.1µF or more). An aluminum electrolytic capacitor is recommended for smoothing capacitor (NJRC recommends 10µF or more). However, you should use large capacitor by sufficient evaluation (assessment) due to load condition and/or application use environment. (There is a possibility that the supply voltage rises by inductive kickback when the supply current of the inductive load is large.) The bypass capacitors should be connected as near as possible to the VDD pin.

CHARACTERISTICS

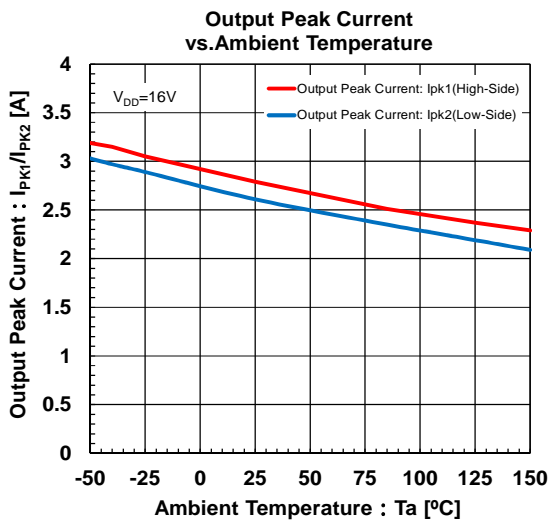
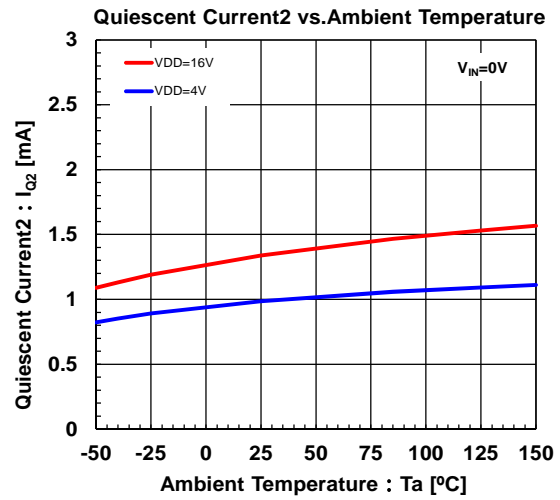
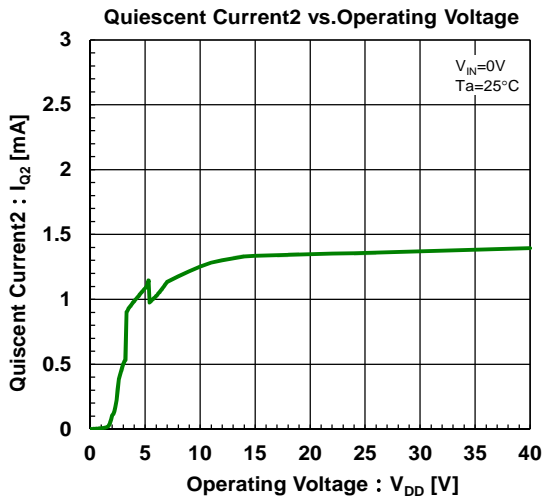
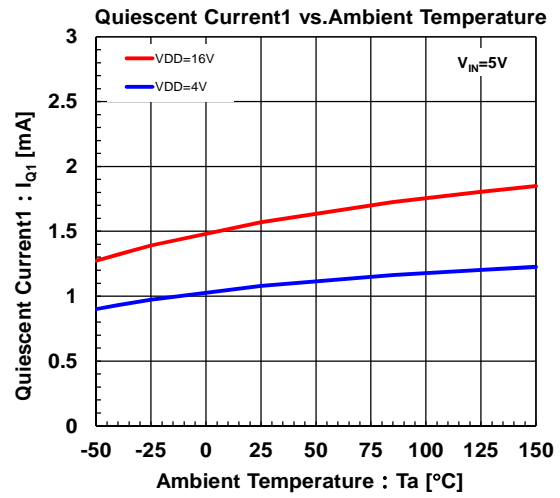
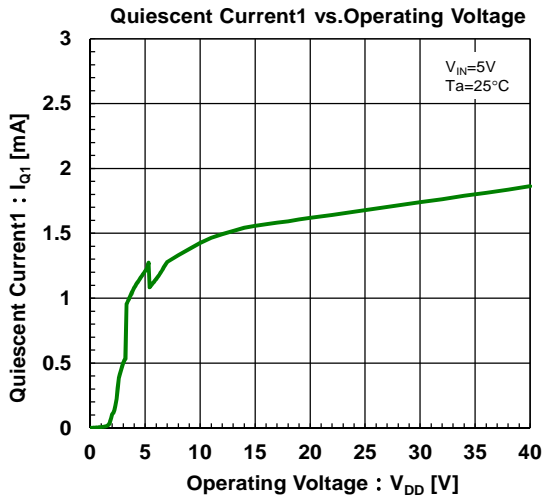

CHARACTERISTICS

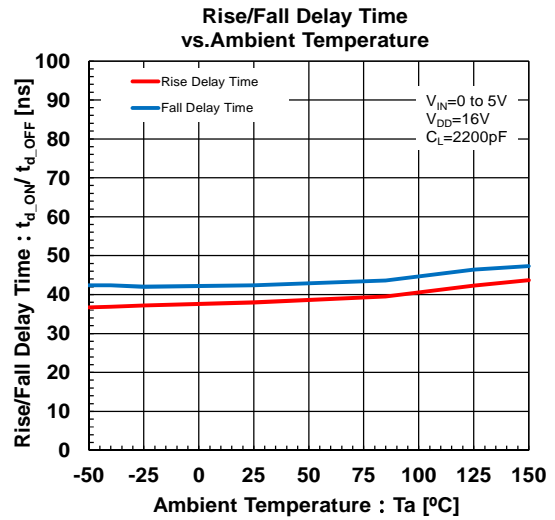
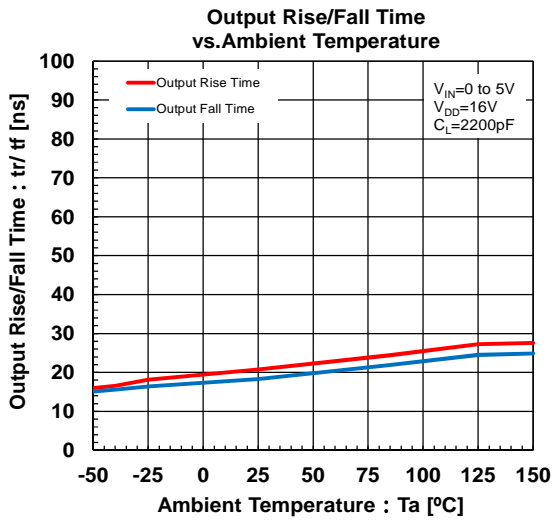
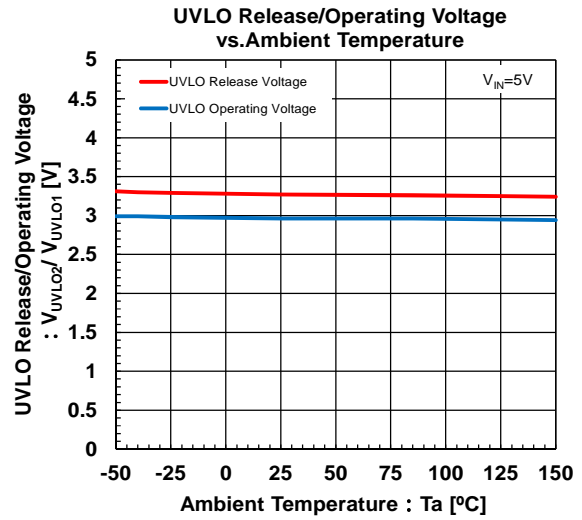
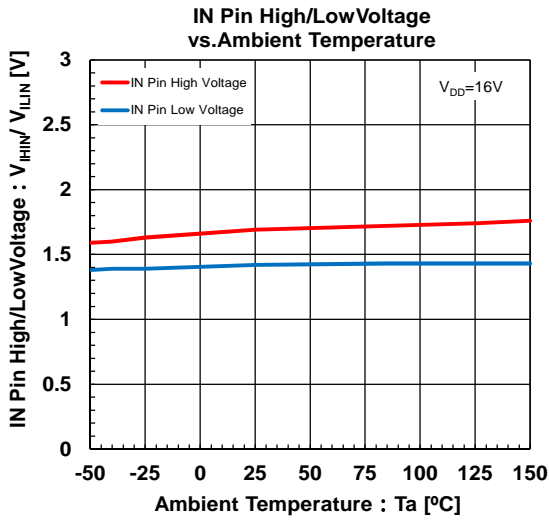
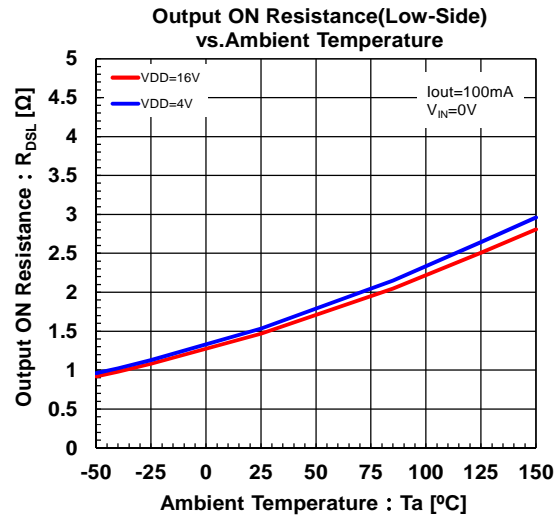
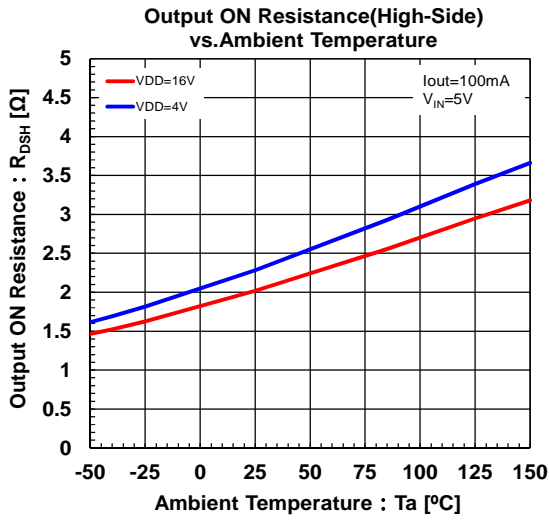

[CAUTION]

The specifications on this datasheets are only given for information , without any guarantee as regards either mistakes or omissions.

The application circuits in this datasheets are described only to show representative usages of the product and not intended for the guarantee or permission of any right including the industrial rights.

Mouser Electronics

Authorized Distributor

Click to View Pricing, Inventory, Delivery & Lifecycle Information:

[NJR:](#)

[NJW4841R-TE1](#) [NJW4841RT1-TE1](#)



Стандарт Электрон Связь

Мы молодая и активно развивающаяся компания в области поставок электронных компонентов. Мы поставляем электронные компоненты отечественного и импортного производства напрямую от производителей и с крупнейших складов мира.

Благодаря сотрудничеству с мировыми поставщиками мы осуществляем комплексные и плановые поставки широчайшего спектра электронных компонентов.

Собственная эффективная логистика и склад в обеспечивает надежную поставку продукции в точно указанные сроки по всей России.

Мы осуществляем техническую поддержку нашим клиентам и предпродажную проверку качества продукции. На все поставляемые продукты мы предоставляем гарантию .

Осуществляем поставки продукции под контролем ВП МО РФ на предприятия военно-промышленного комплекса России , а также работаем в рамках 275 ФЗ с открытием отдельных счетов в уполномоченном банке. Система менеджмента качества компании соответствует требованиям ГОСТ ISO 9001.

Минимальные сроки поставки, гибкие цены, неограниченный ассортимент и индивидуальный подход к клиентам являются основой для выстраивания долгосрочного и эффективного сотрудничества с предприятиями радиоэлектронной промышленности, предприятиями ВПК и научно-исследовательскими институтами России.

С нами вы становитесь еще успешнее!

Наши контакты:

Телефон: +7 812 627 14 35

Электронная почта: sales@st-electron.ru

Адрес: 198099, Санкт-Петербург,
Промышленная ул, дом № 19, литера Н,
помещение 100-Н Офис 331