

Harmony™ 9001K/SK/KX 30 mm push buttons

Catalog
2011



Harmony™ 9001K/SK/KX 30 mm push buttons

Introduction	4
<i>9001K heavy-duty operators with chrome-plated bezels:</i>	
Product range	5
Specifications	7
References	
□ Push buttons and mushroom operators	10
□ Multi-function operators	12
□ Selector switches	13
□ Pilot lights	17
□ Specialty operators	18
□ Contact blocks	20
□ Light modules	24
□ Legend plates	25
□ Accessories	27
□ Replacement parts	29
Dimensions	30
<i>9001SK corrosion-resistant operators with black plastic bezels:</i>	
Product range	36
Specifications	38
References	
□ Push buttons and mushroom operators	41
□ Multi-function operators	43
□ Selector switches	44
□ Pilot lights	48
□ Specialty operators	49
□ Contact blocks	50
□ Light modules	54
□ Legend plates	55
□ Accessories	57
□ Replacement parts	59
Dimensions	60
<i>9001KX multi-function operators with chrome-plated square-head bezels:</i>	
Product range	66
Specifications	67
References	
□ Push buttons with contacts	70
□ Push buttons without contacts	71
□ Selector switches	72
□ Contact blocks	72
□ Pilot lights	73
□ Legend plates	74
□ Accessories	75
Dimensions	76
Index	78

Harmony™ 9001K/SK/KX 30 mm push buttons



Introduction

Schneider Electric's Harmony™ 9001 30 mm push buttons, pilot lights, selector switches and mushroom head operators provide robust and reliable solutions for a wide range of heavy industry applications.

- **9001K** operators are rugged and include chrome-plated bezels. (See page 5.)
- **9001SK** operators include black plastic bezels for corrosion-resistant applications. (See page 36.)
- **9001KX** operators include chrome-plated square bezels and provide multi-function operation. (See page 66.)

Product features:

- Heavy duty, oil-tight, dust-tight, and water-tight without boots. Most units are IP66 rated and are UL types 4, 4X and 13.
- FINGERSAFE™ contact blocks and light modules for improved safety
- Interchangeable light modules, contact blocks, color caps, pilot light lenses and mushroom heads reduce inventory
- Integrated earth ground connection (no ground wires required)
- Easy installation with octagonal ring nut
- Metal or plastic legend plates

Contact block features:

- Clear window for status of contact operation and troubleshooting
- Color coded for easy identification
- Single screw mounting for quick installation
- Side-by-side and/or stacked mounting to minimize enclosure space requirements

Light module features:

- Low-cost incandescent lamps or energy-efficient, long-life LED lamps
- Wide range of voltages from 24V to 600V

All products are:

- UL listed and CSA certified
- CE declaration of conformity
- RoHS compliant

Complete units

Contact functions

Push buttons, spring return



Full guard
9001KR1●●● See page 10



No guard
9001KR3●●● See page 10



Extended guard
9001KR2●●● See page 10

Mushroom head push buttons



Spring return 1-3/8 or 2-1/4 in (35 or 57 mm)
9001KR2●●H13 See page 10



Push-pull 1-5/8 in (41 mm)
9001KR●●● See page 10



Turn-to-release, trigger action
9001KR16 (1) See page 12

Selector switches, key switches and joystick controllers



Selector switches
9001KS●●FBH●● See pages 13 to 15



Key switches
9001KS●●K●H●● See pages 13 to 15



Joystick controllers
9001K●●H● See page 18

Light functions

Pilot lights



BA 9s base mounted super bright LED
9001KP●●● See page 17



BA 9s incandescent bulb
9001KP●●● See page 17

(1) Complies with EN418/ISO13850 standards for Emergency Stop push buttons when used with circular Legend Plate 9001KN8330 (90 mm diameter) or 9001KN9330 (60 mm diameter). See page 26.

Harmony™ 9001K/SK/KX 30 mm push buttons

9001K – Complete units, components and accessories

Complete units

Combined contact and light functions

Illuminated push buttons, spring return



Full guard, super bright LED

9001K●L●● See page 11



No guard

9001K2L●● See page 11



Push-to-test, no guard, super bright LED

9001KT●●●31 See page 11

1-5/8 in (41 mm) mushroom head illuminated push buttons, super bright LED



2-Position, push-pull

9001KR9P●● See page 12



3-Position, push-pull

9001KR8P●● See page 12

Separate components and accessories



Complete units are composed of:

- 1 - Contact block
- 2 - Light module with lamp
- 3 - Black compensation gaskets
- 4 - Legend plate
- 5 - Locking thrust washer (for electrical grounding)
- 6 - Ring nut
- 7 - Color cap
- 8 - Color insert

Specifications:
page 7

References:
page 10

Dimensions:
page 30

Mounting:
page 31

Harmony™ 9001K/SK/KX

30 mm push buttons

9001K

Environmental specifications			
Conforming to standards	 		EN/IEC 60947-1, EN/IEC 60947-5-1, EN/IEC 60947-5-4, JIS C 4520 and 852, UL 508, CSA C22-2 n° 14, CE marked, RoHS compliant
Product certifications	 File E78403 CCN NKCR  File LR25490 Class 3211-03		UL File E78403, CCN NKCR and CSA File LR25490, Class 3211-03
Protective treatment standard version			"TC"
Ambient air temperature around the device	Storage	°F (°C)	-40 to +158 (-40 to +70)
	Operation	°F (°C)	-13 to +158 (-25 to +70)
Vibration resistance	Conforming to IEC 60068-2-6		Frequency: 2 to 500 Hz: 7gn Ford Standard EA-1
Shock resistance	Conforming to IEC 60068-2-27		Half sine wave: 50 gn
Electric shock protection	Conforming to IEC 61140		Class II
Degree of protection	Conforming to EN/IEC 60529		IP 66
	Conforming to NEMA		Types 1, 2, 3, 3R, 4, 12 and 13
Mechanical life (in millions of operating cycles)	Push buttons, spring return		5
	Illuminated push buttons		5
	Selector switches and key switches		0.5
Mounting position			All positions

Electrical characteristics of contact blocks			
Rated operational characteristics	~ AC-15		3 A, 240 V
	--- DC-13		0.55 A, 125 V
Rated insulation voltage	Conforming to EN/IEC 60947-1	V	U _i = 250 degree of pollution 3 (except pilot lights with incandescent bulb: degree of pollution 2)
Rated impulse withstand voltage	Conforming to EN/IEC 60947-1	kV	U _{imp} = 2.5
Contact material	Normal environment and usage		Silver alloy
Contact operation	"N/C" ou "N/O"		Slow break
Positive operation	Conforming to EN/IEC 60947-5-1	N	N/C contact(s) with positive opening operation
Short-circuit protection	Conforming to EN/IEC 60947-5-1	A	Cartridge fuse mounted upstream: 10
Cabling capacity (9001KA contact blocks and 9001KM light modules)	Conforming to EN/IEC 60947-1	mm ² mm ²	Screw clamp terminals (cross headed/slotted screw) Mini: 1 x 0.22 Maxi: 2 x 1.5 Recommended tightening torque: 0.8 N.m (10 in-lbs)
Thermal current	I _{th}	A	10
Maximum operation current	a.c. supply: utilization category AC-15 NEMA A600	Contact making capacity	
		V	120 240 480 600
		A VA	60 30 15 12 7200 7200 7200 7200
	Breaking capacity		
	V	120 240 480 600	
	A VA	6 3 1.5 1.2 720 720 720 720	
d.c. supply: utilization category DC-13 NEMA Q600	Contact making capacity and breaking capacity		
	V A	125 250 600 600 0.55 0.27 0.1 0.1	

Harmony™ 9001K/SK/KX

30 mm push buttons

9001K

Basic Operators

(For Color Caps, Mushroom Buttons, Knobs, Selector Switch Cams, Contact Blocks, Light Modules and Legend Plates, see page 21.)

Description	UL Types/NEMA Types 4, 13
Non Illuminated Push Button (Full Guard)	9001KR1
Non Illuminated Push Button (Extended Guard)	9001KR2
Non Illuminated Push Button (No Guard)	9001KR3
Non Illuminated Push Button (Mushroom Button/screw on)	9001KR20
Non Illuminated Dual Push Button (Momentary)	9001KR6
Non Illuminated Dual Push Button (Momentary Interlocked)	9001KR67
Non Illuminated Dual Push Button (Maintained Interlocked)	9001KR7
Momentary Pull - Maintained Neutral - Momentary Push	9001KR8 (1) (4)
Maintained Pull - Maintained Push	9001KR9 (1) (4)
Illuminated Push Button (Full Guard - Plastic Top)	9001K1L (2)
Illuminated Push Button and Push-to-test (No Guard)	9001K2L (2) (3)
Illuminated Push Button (Full Guard - Metal Top)	9001K3L (2)
Standard Pilot Light	9001KP
2-Position Selector Switch	9001KS1 (1), 9001KS2 (1), 9001KS3 (1)
3-Position Selector Switch	9001KS4 (1), 9001KS5 (1), 9001KS6 (1), 9001KS7 (1)
4-Position Selector Switch	9001KS8 (1)
Trigger-Action Emergency Stop	9001KR16 (1)

(1) Operator can be converted to an illuminated operator by removing the liner (6509704901) and adding a light module.

(2) Operator can be converted to a non-illuminated operator by adding liner (6509704901).

(3) Operator includes jumper wires for push-to-test conversion.

(4) These operators can be supplied with 1-3/8" or 2-1/4" dia. mushroom buttons. For 1-3/8" Add *20 to reference number. The * refers to the color chosen - see page 10. For 2-1/4": Add *21 to reference number. The * refers to the color chosen - see page 10. Voids UL and NEMA Type 6 Rating.

Non Hazardous Locations:



Hazardous Locations (Reed contact blocks, see page 23):



Harmony™ 9001K/SK/KX

30 mm push buttons

9001K

9001K Operator Materials:

Push Button and Push-to-test Pilot Light
(9001KR and 9001KT)

Gasket – Nitrile
Seal – Nitrile
Seal Cap – Amorphous Acetal
Decorative Ring – Polyester Film
Compensating Washer – Polypropylene
Lock Ring – Amorphous Nylon
Stem – Thermoplastic Polyester
Base Cap – Thermoplastic Polyester
Knob – Polycarbonate
Liner – Polypropylene
Hold Down Spring for 9001K-15 – Neoprene
Operator Base – Zinc
Operator Base (9001KR8) – Polyester
Return Spring – Music Wire or Stainless Steel (9001KT only)
Ring Nuts – Aluminum or Zinc
Springkeeper – Steel
Locking Thrust Washer – Zinc
Color Insert – Polyethylene
Boots – Silicone

Selector Switch (9001KS)

Gasket – Nitrile
Seal – Nitrile
Bearing Washer – Polyester Film
Compensating Washer – Polypropylene
Cam Follower – Delrin 100
Liner – Polypropylene
Knob – Polycarbonate
Cam Carrier – Amorphous Nylon
Cam Rotor – Celenex 3300
Cam Profile – Delrin 100
Operator Base – Zinc
Detent Spring – Stainless Steel
Ring Nuts – Aluminum or Zinc
Seal keeper – Stainless Steel
Locking Thrust Washer – Zinc

Pilot Light (9001KP)

Gasket – Nitrile
Compensating Washer – Polypropylene
Lens – Glass or Polycarbonate
Light Module Housing – Thermoplastic Polyester
Operator Base – Zinc
Glass Lens Ring – Anodized Aluminum

Contact Block And Light Module Materials:

Contact Block (9001KA)

Housing – Amorphous Nylon
Contact Slider – Phenolic, Nylon or Acetal
Terminal – Steel
Saddle Clamp – Steel
Spring – Stainless Steel
Contacts – Silver and Copper
Blade – Beryllium Copper
Mounting Screw – Steel
Label – Paper

Light Module (9001KM)

Housing – Thermoplastic Polyester
Socket – Steel
Terminal – Steel with Tin Plate
Saddle Clamp – Steel
Translating Pin – Polycarbonate
Transformer – Thermoplastic Polyester, Steel, Copper,
Polyvinyl Chloride, Polytetrafluorethylene,
Acetate, Paper
Lamp Spring – Tin Plated Music Wire

Harmony™ 9001K/SK/KX 30 mm push buttons

9001K – Push buttons and mushroom operators

Note: When ordering, add prefix “9001” to the reference.

Non-Illuminated Momentary Push Button Operators
For use in hazardous locations, see page 23.
Contact blocks and legend plate not included unless otherwise noted.

Description	Color	Operator with 1 N.O. and 1 N.C. Contact (KA1)	Operator with 1 N.O. Contact (KA2)	Operator with 1 N.C. Contact (KA3)	Operator Only with No Contacts	
 9001KR1B Full Guard	Black	KR1BH13	KR1BH5	KR1BH6	KR1B	
	Red	KR1RH13	KR1RH5	KR1RH6	KR1R	
	Green	KR1GH13	KR1GH5	KR1GH6	KR1G	
	Universal (1)	KR1UH13	KR1UH5	KR1UH6	KR1U	
	Other (2)	KR1■H13	KR1■H5	KR1■H6	KR1■	
 9001KR3B No Guard	Black	KR3BH13	KR3BH5	KR3BH6	KR3B	
	Red	KR3RH13	KR3RH5	KR3RH6	KR3R	
	Green	KR3GH13	KR3GH5	KR3GH6	KR3G	
	Universal (1)	KR3UH13	KR3UH5	KR3UH6	KR3U	
	Other (2)	KR3■H13	KR3■H5	KR3■H6	KR3■	
 9001KR2B Extended Guard	Black	KR2BH13	KR2BH5	KR2BH6	KR2B	
	Red	KR2RH13	KR2RH5	KR2RH6	KR2R	
	Green	KR2GH13	KR2GH5	KR2GH6	KR2G	
	Universal (1)	KR2UH13	KR2UH5	KR2UH6	KR2U	
	Other (2)	KR2■H13	KR2■H5	KR2■H6	KR2■	
 9001KR4B 1-3/8 in (35 mm) Diameter Mushroom Button	Snap-In Plastic Mushroom Button					
	Black	KR4BH13	KR4BH5	KR4BH6	KR4B	
	Red	KR4RH13	KR4RH5	KR4RH6	KR4R	
	Red (3)	KR4R05H13	KR4R05H5	KR4R05H6	KR4R05	
	Green	KR4GH13	KR4GH5	KR4GH6	KR4G	
	Other (4)	KR4★H13	KR4★H5	KR4★H6	KR4★	
	Screw-On Plastic Mushroom Button with Set Screw					
	Black	KR24BH13	KR24BH5	KR24BH6	KR24B	
	Red	KR24RH13	KR24RH5	KR24RH6	KR24R	
	Green	KR24GH13	KR24GH5	KR24GH6	KR24G	
	Other (4)	KR24★H13	KR24★H5	KR24★H6	KR24★	
	 9001KR24BM 1-1/2 in (40 mm) Diameter Mushroom Button	Screw-in Metal Mushroom Button with Set Screw				
		Black	—	—	—	KR24BM
Red		—	—	—	KR24RM	
Green		—	—	—	KR24GM	
 9001KR5B 2-1/4 in (57 mm) Diameter Mushroom Button	Snap-In Plastic Mushroom Button					
	Black	KR5BH13	KR5BH5	KR5BH6	KR5B	
	Red	KR5RH13	KR5RH5	KR5RH6	KR5R	
	Red (3)	KR5R05H13	KR5R05H5	KR5R05H6	KR5R05	
	Green	KR5GH13	KR5GH5	KR5GH6	KR5G	
	Other (4)	KR5★H13	KR5★H5	KR5★H6	KR5★	
	Screw-On Plastic Mushroom Button with Set Screw					
	Black	KR25BH13	KR25BH5	KR25BH6	KR25B	
	Red	KR25RH13	KR25RH5	KR25RH6	KR25R	
	Green	KR25GH13	KR25GH5	KR25GH6	KR25G	
	Other (4)	KR25★H13	KR25★H5	KR25★H6	KR25★	
	 9001KR25BM 2-3/8 in (60 mm) Diameter Mushroom Button	Screw-in Metal Mushroom Button with Set Screw				
		Black	—	—	—	KR25BM
Red		—	—	—	KR25RM	
	Green	—	—	—	KR25GM	

(1) The universal push button operators contain one each of the following color inserts: black, red, green, yellow, orange, blue and white.
 (2) Replace ■ with the color code as chosen from the color code table below.
 (3) Knob has the words “Emergency Stop” in raised letters highlighted in white for readability.
 (4) Replace ★ with the color code as chosen from the color code table below.

Color Codes

Color	KR1, 2, 3 Place Color Code in Reference ■	KR4, 5, 24, 25 Place Color Code in Reference ★
Blue	L	L
Yellow	Y	Y
White	W	—
Orange	S	S
Gray	E	—

To select and order Contact Blocks, Light Modules, Knobs, and Accessories, see pages 20 to 29.

Product range:
page 5

Specifications:
page 7

Dimensions:
page 30

Mounting:
page 31

Harmony™ 9001K/SK/KX

30 mm push buttons

9001K – Push buttons and mushroom operators

Note: When ordering, add prefix “9001” to the reference.

Illuminated Momentary Push Button Operators

For use in hazardous locations, see page 23.

Legend plate and contact block not included unless otherwise noted.

Description	Voltage and Frequency	Style	With Red Color Cap and 1 N.O. and 1 N.C. Contact (KA1) (2)	With Green Color Cap and 1 N.O. and 1 N.C. Contact (KA1) (2)	With Other Color Cap Without Contact Block (1) (2) (5)
 Full Guard Illuminated Push Button Clear Plastic Top 9001K1L1	110–120 V, 50–60 Hz	Transformer	K1L1RH13	K1L1GH13	K1L1▼
	220–240 V, 50–60 Hz	Transformer	K1L7RH13	K1L7GH13	K1L7▼
	24–28 Vac/Vdc	Full Voltage	K1L35RH13	K1L35GH13	K1L35▼
	For other voltages (2)	Transformer or Flashing	K1L■RH13	K1L■GH13	K1L■▼
		Full Voltage	K1L■RH13	K1L■GH13	K1L■▼
		Resistor or Neon (3)	K1L■RH13	K1L■GH13	K1L■▼
 Full Guard Illuminated Push Button Metal Top 9001K3L1	110–120 V, 50–60 Hz	Transformer	K3L1RH13	K3L1GH13	K3L1▼
	220–240 V, 50–60 Hz	Transformer	K3L7RH13	K3L7GH13	K3L7▼
	24–28 Vac/Vdc	Full Voltage	K3L35RH13	K3L35GH13	K3L35▼
	For other voltages (2)	Transformer or Flashing	K3L■RH13	K3L■GH13	K3L■▼
		Full Voltage	K3L■RH13	K3L■GH13	K3L■▼
		Resistor or Neon (3)	K3L■RH13	K3L■GH13	K3L■▼
 No Guard Illuminated Push Button 9001K2L1	110–120 V, 50–60 Hz	Transformer	K2L1RH13	K2L1GH13	K2L1▼
	220–240 V, 50–60 Hz	Transformer	K2L7RH13	K2L7GH13	K2L7▼
	24–28 Vac/Vdc	Full Voltage	K2L35RH13	K2L35GH13	K2L35▼
	For other voltages (2)	Transformer or Flashing	K2L■RH13	K2L■GH13	K2L■▼
		Full Voltage	K2L■RH13	K2L■GH13	K2L■▼
		Resistor or Neon (3)	K2L■RH13	K2L■GH13	K2L■▼
 1-3/8 in (35 mm) Illuminated Screw-On Plastic Mushroom (no Set Screw) 9001K2LR20	110–120 V, 50–60 Hz	Transformer	K2L1R20H13	K2L1G20H13	Order K2L■▼ above (6)
	220–240 V, 50–60 Hz	Transformer	K2L7R20H13	K2L7G20H13	
	24–28 Vac/Vdc	Full Voltage	K2L35R20H13	K2L35G20H13	
	For other voltages (2)	Transformer or Flashing	K2L■R20H13	K2L■G20H13	
		Full Voltage	K2L■R20H13	K2L■G20H13	
		Resistor or Neon (3)	K2L■R20H13	K2L■G20H13	
 2-1/4 in (57 mm) Illuminated Screw-On Plastic Mushroom (no Set Screw) 9001K2LR21	110–120 V, 50–60 Hz	Transformer	K2L1R21H13	K2L1G21H13	Order K2L■▼ above (6)
	220–240 V, 50–60 Hz	Transformer	K2L7R21H13	K2L7G21H13	
	24–28 Vac/Vdc	Full Voltage	K2L35R21H13	K2L35G21H13	
	For other voltages (2)	Transformer or Flashing	K2L■R21H13	K2L■G21H13	
		Full Voltage	K2L■R21H13	K2L■G21H13	
		Resistor or Neon (3)	K2L■R21H13	K2L■G21H13	
		LED (4)	K2L■R21H13	K2L■G21H13	

- These operators can be ordered complete with contact blocks. For maximum block usage, see page 22. Add the “H” number chosen from page 22 to the end of the operator reference number and add the cost of the “H” number to the operator cost.
- Replace ■ with the voltage assembly code as chosen from the tables on page 24. Example: K2L■ with 240 Vac/Vdc = K2L25
- On neon light modules, use clear color caps only.
- The cap must be the same color as the LED light module chosen, e.g., for red LED, use red color cap.
- Replace ▼ with the color code as chosen from the color cap table below. Example: K2L25▼ with a blue 13/8 mushroom button = K2L25L20
- The only difference between a no guard (K2L) operator and mushroom button operator is the color cap.

Color Caps

Color	Color Codes		
	▼ K1L, K2L, K3L	▼ 1-3/8 in Mushroom	▼ 2-1/4 in Mushroom
Red	R	R20	R21
Green	G	G20	G21
Blue	L	L20	L21
Yellow	Y	Y20	Y21
White	W	W20	W21
Clear	C	C20	C21
Amber	A	A20	A21

To select and order Contact Blocks, Light Modules, Knobs, and Accessories, see pages 20 to 29.

Harmony™ 9001K/SK/KX

30 mm push buttons

9001K – Multi-function operators

Note: When ordering, add prefix “9001” to the reference.

30 mm Multi-function Operators

Non-Illuminated Push-Pull Mushroom Operators

Description (1)	Color	With 2 N.C. Contacts (1 KA3, 1 KA5) (2)	With 1 N.O. & 1 N.C. Contact (1 KA1) (2)	Without Contacts (2) (6)	
 <p>9001KR9R94H13 Set Screw Style</p>	3-Position Momentary Pull, Maintained Neutral, Momentary Push 1-5/8 in (40 mm) Screw-On Plastic Mushroom (no Set Screw) (8)	Red Green Other	KR8RH25 KR8GH25 KR8▲H25	— — —	
	2-Position, Maintained Pull, Maintained Push, 1-5/8 in (40 mm) Screw-On Plastic Mushroom (no Set Screw) (9)	Red (7) Green Other	— — —	KR9RH13 KR9GH13 KR9▲H13	
	2-Position, Maintained Pull, Maintained Push, 1-5/8 in (40 mm) Screw-On Plastic Mushroom (with Set Screw) (9)	Red	—	KR9R94H13	KR9R KR9G KR9▲ KR9R94
 <p>9001KR9RM94</p>	2-Position Maintained Pull, Maintained Push 1-5/8 in (40 mm) Screw-On Metal Mushroom (with Set Screw)	Black Red Green	— — —	— — —	
	 <p>9001KR9RM95</p>	2-Position Maintained Pull, Maintained Push 2-3/8 in (60 mm) Screw-On Metal Mushroom (with Set Screw)	Black Red Green	— — —	KR9BM94 KR9RM94 KR9GM94
					KR9BM95 KR9RM95 KR9GM95

Non-Illuminated Turn-To-Release Mushroom Operators

Description	Color	With 1 N.O. & 1 N.C. Contact (KA1)	With 2 N.O. & 2 N.C. Contacts (KA2)	Without Contacts
 <p>9001KR16H2 Trigger Action</p>	2-Position Trigger-Action, Turn-to-Release 1-5/8 in. (40 mm) Non-Removal Plastic Mushroom Complies with EN418/ISO13850 standards for Emergency Stop push buttons when used with circular Legend Plate 9001KN8330 (90 mm diameter) or 9001KN9330 (60 mm diameter). See page 26.	Red KR16H13	Red KR16H2	Red KR16

Illuminated Push-Pull Mushroom Operators

Description (1)	Voltage	With Red Knob and 2 N.C. Contacts (1 KA3, 1 KA5) (3)	With Other Color Knob and 2 N.C. Contacts (1 KA3, 1 KA5) (2) (3)	With Other Color Knob Without Contacts (2) (3) (6)
 <p>9001KR9P1 1-5/8 in Diameter Knob with “Pull To Start / Push To Stop” 9001KN379 Legend Plate</p> <p>For 1-3/8 in or 2-1/4 in Diameter Knob (1)</p>	3-Position Illuminated Momentary Pull Maintained Neutral Momentary Push (8)	110-120 V, 50-60 Hz Other - Transformer, LED, Flashing (4) Other - Full Voltage, Resistor, Neon (5)	KR8P1RH25 KR8P■RH25 KR8P■RH25	KR8P1▲ KR8P■▲ KR8P■▲
	2-Position Illuminated Maintained Pull Maintained Push (9)	110-120 V, 50-60 Hz Other - Transformer, LED, Flashing (4) Other - Full Voltage, Resistor, Neon (5)	KR9P1RH13 KR9P■RH13 KR9P■RH13	KR9P1▲H13 KR9P■▲H13 KR9P■▲H13

- (1) For 1-3/8 in or 2-1/4 in dia. knob:
 - a) Order Type -20 or -21 knob from page 28.
 - b) Order 9001K54 adapter (no charge)—allows Type -20 or -21 knob to fit on push pull operators. Voids UL and NEMA 6 rating.
 - c) Can order assembled operator by adding color code to Type -20 or -21. Example: 9001KR9R would be 9001KR9R20 or 9001KR9R21.
- (2) Replace ▲ with the color code as chosen from the color code table below. Example: KR9▲ with a yellow knob = KR9Y
- (3) Replace ■ with the voltage assembly code as chosen from the tables on page 24. Example: KR8P■ with a 277 V 50-60 Hz voltage = KR8P8
- (4) The knob must be the same color as the LED light module chosen, for example, for a green LED, use a green knob.
- (5) On neon light modules, use clear knobs only.
- (6) These operators can be ordered complete with contact blocks. For maximum block usage, see page 22. Add the “H” number chosen from page 22 to the end of the operator reference number.
- (7) To obtain a red knob with “Push Emergency Stop” printed on the red knob, substitute “R05” in place of “R”.
- (8) See page 16 for contact sequences.
- (9) See table below.

Other Color Code Selection

Color	KR6, KR7, KR67	KR11, KR12	KR8, KR9	Color	KR6, KR7, KR67	KR11, KR12	KR8, KR9
Black (1) B	B	B	White	—	W	W	
Red R	R	R	Orange (1) —	—	S	S	
Green G	G	G	Clear	—	—	C	
Blue	—	L	Amber	—	—	A	
Yellow	—	Y	Gray	—	E	—	

(1) These colors are not available on illuminated push-pull operators.

To select and order Contact Blocks, Light Modules, Knobs, and Accessories, see pages 20 to 29.

Contact Sequences

9001KR8RH1 or H13				
		Pull	Ctr	Push
(KA1)	KA3	x	O	O
	KA2	O	O	x
9001KR8RH25				
KA3		x	O	O
KA5		x	x	O
KA2		O	O	x

O = contact open; x = contact closed

Harmony™ 9001K/SK/KX

30 mm push buttons

9001K – Selector switches

Note: When ordering, add prefix “9001” to the reference.

2-Position Selector Switches

Contact Block Required				1 — Contact Closed		0 — Contact Open					
Contact Block Position	Quantity and Type KA1 or KA2 or KA3		Mount on Side KA1 or KA2 or KA3		Left	Right	Left	Right			
	 <p>Top View</p>	KA1	or	KA3	KA1 #2	or	KA3 #2	1	0	0	1
			KA2			KA2 #2	0	1	1	0	
KA1		or	KA3	KA1 #1	or	KA3 #1	1	0	0	1	
			KA2			KA2 #1	0	1	1	0	
Cam (see page 16)				E		D					

Non-Illuminated Operators

Manual Return (1), Operator Only (without contact blocks)	Reference	Reference
Without Knob	KS11	KS12
With Knob (select style and color from table below)	KS11	KS12
Key Operated with E10 Key (Code 1,2,3)	KS11K	KS12K
Operator with Contact Blocks and Standard black knob	Reference	Reference
With 1 KA1 on Side #2	KS11BH13	—
With 1 KA1 on Side #1	KS11BH1	—
With 1 KA1 on Side #1 and 1 KA1 on side #2	KS11BH2	—
Spring Return from Left (1), Operator Only (without contact blocks)	Reference	Reference
Without Knob	KS25	—
With Knob (select style and color from table below)	KS25	—
Key Operated with E10 Key (Code 2 only) (4)	KS25K2★	—
Spring Return from Right (1), Operator Only (without contact blocks)	Reference	Reference
Without Knob	—	KS34
With Knob (select style and color from table below)	—	KS34
Key Operated with E10 Key (Code 1 only)	—	KS34K1

Illuminated Operators

Manual Return (1), Operator Only (without contact blocks)	Reference	Reference
Without Knob, 110-120V 50-60 Hz Transformer	K11J1	K12J1
With Standard Red Knob, 110-120V 50-60 Hz Transformer	K11J1R	K12J1R
With Other Color Knob and other voltage Light Module (2) (3)	K11J■◆	K12J■◆
Spring Return from Left (1), Operator Only (without contact blocks)	Reference	Reference
Without Knob, 110-120V 50-60 Hz Transformer	K25J1	—
With Standard Red Knob, 110-120V 50-60 Hz Transformer	K25J1R	—
With Other Color Knob and other voltage Light Module (2) (3)	K25J■◆	—
Spring Return from Right (1), Operator Only (without contact blocks)	Reference	Reference
Without Knob, 110-120V 50-60 Hz Transformer	—	K34J1
With Standard Red Knob, 110-120V 50-60 Hz Transformer	—	K34J1R
With Other Color Knob and other voltage Light Module (2) (3)	—	K34J■◆

(1) These operators can be ordered complete with contact blocks. Add the “H code” from page 21 as needed for your application.
 (2) Replace ■ with the voltage assembly code as chosen from the tables on page 24. Example: K25J■ with 208 Vac = K25J3.
 (3) Replace ◆ with the knob color code as chosen from the table below. For LED, knob color must match LED.
 (4) Replace ★ with the key withdrawal code from the table below right.

Selector Switch Assembly Code and Knob Cat. No.

Color	Standard Knob		Gloved Hand Knob	
	◆ Knob Code	Reference	◆ Knob Code	Reference
Black	B	B11	FB	B25
Red	R	R8	FR	R24
Green	G	G8	FG	G24
Yellow	Y	Y8	FY	Y24
Blue	L	L8	FL	L24
White	W	W8	FW	W24
Amber	A	A8	FA	A24
Clear	C	C8	FC	C24

Key Withdrawal Codes

★ Code	Position
1	Left Only
2	Right Only
3	Left and Right



To select and order Contact Blocks, Light Modules, Knobs, and Accessories, see pages 20 to 29.

Harmony™ 9001K/SK/KX

30 mm push buttons

9001K – Selector switches

Note: When ordering, add prefix “9001” to the reference.

3-Position Selector Switches

Contact Block Required			1 — Contact Closed 0 — Contact Open									
Quantity and Type	Mount on Side	Center	Center	Center	Center	Center	Center	Center	Center	Center	Center	
Position	Type	Left	Right	Left	Right	Left	Right	Left	Right	Left	Right	
	KA1 or KA3 #2	0	0	0	0	0	0	0	0	0	0	
	KA2 #2	0	1	1	0	0	1	0	0	1	0	
	KA1 or KA3 #1	0	0	1	1	0	0	0	1	0	0	
	KA2 #1	1	1	0	0	0	1	0	0	1	0	
Cam (see page 16)			B	C	D	E	F	G	J	L	M	

Non-Illuminated Operators

Manual Return, Operator Only (without contact blocks) (1)									
Without Knob	KS42	KS43	KS44	KS45	KS46	KS47	KS49	KS401	KS402
With Knob (3)	KS42♦	KS43♦	KS44♦	KS45♦	KS46♦	KS47♦	KS49♦	KS401♦	KS402♦
Key Operated with E10 Key (Code 4 through 10) (5)	KS42K▼	KS43K▼	KS44K▼	KS45K▼	KS46K▼	KS47K▼	KS49K▼	KS401K▼	KS402K▼
Operator with Contact Blocks and Standard black knob (4)									
With 1 KA1 on Side #2 (H13)	KS42BH13	KS43BH13	KS44BH13	KS45BH13	KS46BH13	KS47BH13	KS49BH13	KS401BH13	KS402BH13
With 1 KA1 on Side #1 (H1)	KS42BH1	KS43BH1	KS44BH1	KS45BH1	KS46BH1	KS47BH1	KS49BH1	KS401BH1	KS402BH1
With 1 KA1 on Side #1 and 1 KA1 on side #2 (H2)	KS42BH2	KS43BH2	KS44BH2	KS45BH2	KS46BH2	KS47BH2	KS49BH2	KS401BH2	KS402BH2
Spring Return from Left to Center, Operator Only (without contact blocks) (1)									
Without Knob	KS62	KS63	KS64	KS65	KS66	KS67	KS69	KS601	KS602
With Knob (3)	KS62♦	KS63♦	KS64♦	KS65♦	KS66♦	KS67♦	KS69♦	KS601♦	KS602♦
Key Operated with E10 Key (Code 5, 6 or 9 only) (5)	KS62K▼	KS63K▼	KS64K▼	KS65K▼	KS66K▼	KS67K▼	KS69K▼	KS601K▼	KS602K▼
Spring Return from Right to Center, Operator Only (without contact blocks) (1)									
Without Knob	KS72	KS73	KS74	KS75	KS76	KS77	KS79	KS701	KS702
With Knob (3)	KS72♦	KS73♦	KS74♦	KS75♦	KS76♦	KS77♦	KS79♦	KS701♦	KS702♦
Key Operated with E10 Key (Code 4, 5 or 7 only) (5)	KS72K▼	KS73K▼	KS74K▼	KS75K▼	KS76K▼	KS77K▼	KS79K▼	KS701K▼	KS702K▼
Spring Return from Both Sides to Center, Operator Only (without contact blocks) (1)									
Without Knob	KS52	KS53	KS54	KS55	KS56	KS57	KS59	KS501	KS502
With Knob (3)	KS52♦	KS53♦	KS54♦	KS55♦	KS56♦	KS57♦	KS59♦	KS501♦	KS502♦
Key Operated with E10 Key (Code 4, 5 or 7 only) (5)	KS52K▼	KS53K▼	KS54K▼	KS55K▼	KS56K▼	KS57K▼	KS59K▼	KS501K▼	KS502K▼

Illuminated Operators

Manual Return, Operator Only (without contact blocks) (1)									
Without Knob, 110-120V 50-60 Hz Transformer	K42J1	K43J1	K44J1	K45J1	K46J1	K47J1	K49J1	K401J1	K402J1
With Standard Red Knob, 110-120V 50-60 Hz Transformer	K42J1R	K43J1R	K44J1R	K45J1R	K46J1R	K47J1R	K49J1R	K401J1R	K402J1R
With Other Color Knob and other voltage Light Module (2) (3)	K42J■♦	K43J■♦	K44J■♦	K45J■♦	K46J■♦	K47J■♦	K49J■♦	K401J■♦	K402J■♦
Spring Return from Left to Center, Operator Only (without contact blocks) (1)									
Without Knob, 110-120V 50-60 Hz Transformer	K62J1	K63J1	K64J1	K65J1	K66J1	K67J1	K69J1	K601J1	K602J1
With Standard Red Knob, 110-120V 50-60 Hz Transformer	K62J1R	K63J1R	K64J1R	K65J1R	K66J1R	K67J1R	K69J1R	K601J1R	K602J1R
With Other Color Knob and other voltage Light Module (2) (3)	K62J■♦	K63J■♦	K64J■♦	K65J■♦	K66J■♦	K67J■♦	K69J■♦	K601J■♦	K602J■♦
Spring Return from Right to Center, Operator Only (without contact blocks) (1)									
Without Knob, 110-120V 50-60 Hz Transformer	K72J1	K73J1	K74J1	K75J1	K76J1	K77J1	K79J1	K701J1	K702J1
With Standard Red Knob, 110-120V 50-60 Hz Transformer	K72J1R	K73J1R	K74J1R	K75J1R	K76J1R	K77J1R	K79J1R	K701J1R	K702J1R
With Other Color Knob and other voltage Light Module (2) (3)	K72J■♦	K73J■♦	K74J■♦	K75J■♦	K76J■♦	K77J■♦	K79J■♦	K701J■♦	K702J■♦
Spring Return from Both Sides to Center, Operator Only (without contact blocks) (1)									
Without Knob, 110-120V 50-60 Hz Transformer	K52J1	K53J1	K54J1	K55J1	K56J1	K57J1	K59J1	K501J1	K502J1
With Standard Red Knob, 110-120V 50-60 Hz Transformer	K52J1R	K53J1R	K54J1R	K55J1R	K56J1R	K57J1R	K59J1R	K501J1R	K502J1R
With Other Color Knob and other voltage Light Module (2) (3)	K52J■♦	K53J■♦	K54J■♦	K55J■♦	K56J■♦	K57J■♦	K59J■♦	K501J■♦	K502J■♦

(1) These operators can be ordered complete with contact blocks. Add the “H code” from page 21 as needed for your application.
 (2) Replace ■ with the voltage assembly code as chosen from the tables on page 24. Example: K25J■ with 208 Vac = K25J3.
 (3) Replace ♦ with the knob color code as chosen from the table below. For LED, knob color must match LED.
 (4) For other color knobs replace the B with knob color code from table below.
 (5) Replace ▼ with the key withdrawal code from table below right. Example: KS43K▼ with key withdrawal in the right position only = KS43K6.

Selector Switch Assembly Code and Knob Cat. No.

Color	Standard Knob		Gloved Hand Knob	
	♦ Knob Code	Reference	♦ Knob Code	Reference
Black	B	B11	FB	B25
Red	R	R8	FR	R24
Green	G	G8	FG	G24
Yellow	Y	Y8	FY	Y24
Blue	L	L8	FL	L24
White	W	W8	FW	W24
Amber	A	A8	FA	A24
Clear	C	C8	FC	C24

Key Withdrawal Codes

▼ Code	Position
4	Left Only
5	Center Only
6	Right Only
7	Left and Center
8	Left and Right
9	Center and Right
10	Left, Center, and Right

To select and order Contact Blocks, Light Modules, Knobs, and Accessories, see pages 20 to 29.



Note: When ordering, add prefix “9001” to the reference.

4-Position Selector Switches

Contact Block Required			1 — Contact Closed 0 — Contact Open		
Contact Block Position	Quantity and Type KA1 or KA2 or KA3		Mount on Side KA1 or KA2 or KA3		
<p>Top View</p>	KA1	or	KA3	KA1 or KA3 #2	1 0 0 0
				KA2 #2	0 0 1 0
	KA1	or	KA3	KA1 or KA3 #1	0 0 0 1
				KA2 #1	0 1 0 0

Cam (see page 16)

H

Non-Illuminated Operators

Manual Return (1), Operator Only (without contact blocks)	Reference
Without Knob	KS88
With Knob (3)	KS88♦
Key Operated with E10 Key (Codes 11, 12, 13, 14, 15) (4)	KS88K★

Illuminated Operators

Manual Return (1), Operator Only (without contact blocks)	Reference
Without Knob, 110-120V 50-60 Hz Transformer	KS88J1
With Standard Red Knob, 110-120V 50-60 Hz Transformer	KS88J1R
With Other Color Knob and other voltage Light Module (2) (3)	KS88J■♦

(1) These operators can be ordered complete with contact blocks. Add the “H code” from page 21 as needed for your application.

(2) Replace ■ with the voltage assembly code as chosen from the tables on page 24. Example: K25Jb with 208Vac = K25J3.

(3) Replace ♦ with the knob color code as chosen from the table below. For LED, knob color must match LED.

(4) Replace ★ with the key withdrawal code from the table below right.

Selector Switch Assembly Code and Knob Cat. No.

Color	Standard Knob		Gloved Hand Knob	
	◆ Knob Code	Reference	◆ Knob Code	Reference
Black	B	B11	FB	B25
Red	R	R8	FR	R24
Green	G	G8	FG	G24
Yellow	Y	Y8	FY	Y24
Blue	L	L8	FL	L24
White	W	W8	FW	W24
Amber	A	A8	FA	A24
Clear	C	C8	FC	C24

Key Withdrawal Codes

★ Code	Position
11	1 and 4
12	4 only
13	1 only
14	1, 2, 3 and 4
15	2, 3, and 4



Potentiometers with Dial Plate (not UL listed)—Maximum Voltage 300 Vac

Power	Description	Ratings	Reference
2 W	Operator Only, for Single Potentiometer	NEMA 4, 13	K20
	Operator with Single Potentiometer		K21
	Operator Only, for Tandem Potentiometer		K22
	Operator with Tandem Potentiometer		K23



Potentiometer Suffixes

Single Potentiometer			
Suffix (5)	Resistance	Suffix (5)	Resistance
01	50 Ω	07	5 kΩ
02	100 Ω	08	10 kΩ
04	500 Ω	09	25 kΩ
05	1 kΩ	13	500 kΩ
39	2 kΩ	37	750 kΩ
06	2.5 kΩ	14	1 MΩ

Tandem Potentiometer			
Suffix (5)	Resistance		
	Front	Rear	
82	1 kΩ	1 kΩ	

(5) For the complete reference, add the suffix from Suffix column to the reference from Reference column in “Potentiometer with Dial Plate” table above. Example: 9001 K21 05.

Any potentiometer with a shaft 7/8" long and 1/4" diameter may be used with these operators. To select and order Contact Blocks, Light Modules, Knobs, and Accessories, see pages 20 to 29.

Harmony™ 9001K/SK/KX

30 mm push buttons

9001K – Selector switch guide

Note: When ordering, add prefix “9001” to the reference.

Shown below is a simplified method of selecting a selector switch to meet almost any combination of contact sequences.

Step No. 1

Determine the contact sequence(s) required. Set up a target table like the one shown for the example below.

Contact Sequence	0—contact open	1—contact closed	↖	↑	↗
A			1	0	0
B			0	1	0
C			0	0	1

Step No. 2

Look for a cam type common to all sequences in the three tables to the right. For the example above, the “3-Position Selector Switch” table would be used. For the contact sequences A (1 0 0), B (0 1 0) and C (0 0 1) of the example above, cam types F and L are common to all three sequences.

Step No. 3

Next, use the cam type common to all the sequences (if several cam types are common, choose one) to find the operator reference number. Go to the proper page number as indicated in the table below:

Number of Positions	Push Button Line	Page Number
2	9001KS	13
3	9001KS	14
4	9001KS	15

If for the example above a manual return operator with a standard black knob is required and:

The F cam type is chosen, the operator reference number is:

- 9001K—Class 9001 Reference KS46B (from page 14)

The L cam type is chosen, the operator reference number is:

- 9001K—Class 9001 Reference KS401B (from page 14)

Step No. 4

Determine the contact blocks required by using the same table in Step No. 2.

If, for the example above, the F cam type is chosen:

- Use a 9001KA3 mounted on side no. 2 for sequence A (1 0 0).
- Use a 9001KA3 mounted on side no. 1 for sequence B (0 1 0).
- Use a 9001KA2 mounted on side no. 1 or 2 for sequence C (0 0 1).

If, for the example above, the L cam type is chosen:

- Use a 9001KA2 mounted on side no. 2 for sequence A (1 0 0).
- Use a 9001KA2 mounted on side no. 1 or a 9001KA3 mounted on side no. 2 for sequence B (0 1 0).
- Use a 9001KA3 mounted on side no. 1 for sequence C (0 0 1).

One 9001KA1 double circuit block can be used in place of one 9001KA2 single circuit block plus one 9001KA3 single circuit block mounted on the same side.

2-Position Selector Switch

If you require contact sequence—	Use Cam Type	Use Contact Block Reference	Mount on side no. (See page 21)
1 0	E	KA3	1 or 2
	D	KA2	1 or 2
0 1	E	KA2	1 or 2
	D	KA3	1 or 2

3-Position Selector Switch

If you require contact sequence—	Use Cam Type	Use Contact Block Reference	Mount on side no. (See page 21)
1 0 0	G, M	KA2	1
	L	KA2	2
	C, E	KA3	1
	B, C, E, F, G, J	KA3	2
	B, G, J	KA5(1)	2
0 1 0	D, E, J, L	KA2	1
	D, E	KA2	2
	F	KA3	1
	L	KA3	2
0 0 1	C, F	KA2	1 or 2
	B, D, G, L	KA3	1
	D	KA3	2
	B	KA5(1)	1
	M	KA2	2
1 1 0	B	KA2	1
	C, F	KA5(1)	1 or 2
	M	KA3	2
0 1 1	B, G, J, L	KA2	2
	G	KA5(1)	1
	L	KA5(1)	2
	M	KA3	1
1 0 1	J, L	KA3	1
	D, E, J, L	KA5(1)	1
	D, E	KA5(1)	2

4-Position Selector Switch

If you require contact sequence—	Use Cam Type	Use Contact Block Reference	Mount on side no. (See page 21)
1 0 0 0	H	(A) KA3	2
0 1 0 0	H	(B) KA2	1
0 0 1 0	H	(C) KA2	2
0 0 0 1	H	(D) KA3	1
1 0 0 1	H	A & D Wired in Parallel	
1 1 0 0	H	A & B Wired in Parallel	
0 1 1 0	H	B & C Wired in Parallel	
0 0 1 1	H	C & D Wired in Parallel	
1 1 1 0	H	A, B & C Wired in Parallel	
0 1 1 1	H	B, C & D Wired in Parallel	
1 0 1 0	H	A & C Wired in Parallel	
0 1 0 1	H	B & D Wired in Parallel	
1 1 0 1	H	KA5(1)	2
1 0 1 1	H	KA5(1)	1

(1) 9001KA5 must be the last block on either side.

$$KA1 = KA3 + KA2$$



When ordering, please specify:

- Quantity
- Class Number
- Type or Reference

For “H” Numbers, see page 22.

Harmony™ 9001K/SK/KX

30 mm push buttons

9001K – Pilot lights

Note: When ordering, add prefix “9001” to the reference.

Pilot Lights—UL Types 4, 13/NEMA 4 & 13
For use in hazardous locations, see page 23.
Legend plates not included.

Description	Voltage	Style	With Red Fresnel Color Cap (1)	With Green Fresnel Color Cap (1)	With Other Color Cap (1) (2)	Without Color Cap (1)
 Standard Pilot Light (Plastic Fresnel Color Cap Shown)	110–120 V, 50–60 Hz 220–240 V, 50–60 Hz 24–28 Vac/Vdc	Transformer Transformer Full Voltage	KP1R31 KP7R31 KP35R31	KP1G31 KP7G31 KP35G31	KP1■ KP7■ KP35■	KP1 KP7 KP35
	For other voltages see page 24.	Transformer, Flashing or LED (3) Full Voltage, Neon or Resistor (4)	KP▲R31 KP▲R31	KP▲G31 KP▲G31	KP▲■ KP▲■	KP▲ KP▲
 Push-To-Test Pilot Light (Glass Color Cap Shown)	110–120 V, 50–60 Hz 220–240 V, 50–60 Hz 24–28 Vac/Vdc	Transformer Transformer Full Voltage	KT1R31 KT7R31 KT35R31	KT1G31 KT7G31 KT35G31	KT1■ KT7■ KT35■	KT1 KT7 KT35
	For other voltages see page 24.	Transformer, Flashing or LED (3) Full Voltage, Neon or Resistor (4)	KT▲R31 KT▲R31	KT▲G31 KT▲G31	KT▲■ KT▲■	KT▲ KT▲
 Remote Test Pilot Light (Glass Color Cap Shown)	120 Vac Only 24–28 Vac Only for other voltages	Resistor (5) Full Voltage (5)	KTR38R31 KTR35R31	KTR38G31 KTR35G31	KTR38■ KTR35■	KTR38 KTR35
	For other voltages see page 24.	Full Voltage or Resistor (5)	KTR▲R31	KTR▲G31	KTR▲■	KTR▲

(1) Replace ▲ with the voltage assembly code as chosen from the tables on page 24. Example: KT▲R31 with 208 Vac red LED = KT37LRR31
 (2) Replace ■ with the color code as chosen from the color code table below. Example: KP1■ with a blue fresnel cap = KP1L31
 (3) The cap must be the same color as the LED light module chosen, e.g., for green LED, use green color cap.
 (4) On neon light modules, use clear color caps only.
 (5) On remote test pilot lights use only full voltage or resistor voltage assembly codes. Do not choose LED, neon or transformer codes. For AC use only.

Color Caps

Color	■ Plastic Fresnel	■ Plastic Domed	■ Glass
Amber	A31	A9	A6
Blue	L31	L9	L6
Clear	C31	C9	C6
Green	G31	G9	G6
Red	R31	R9	R6
White	W31	W9	W6
Yellow	Y31	Y9	Y6

Typical Wiring Diagrams



Push-to-test Pilot Light



Remote Test Pilot Light

Harmony™ 9001K/SK/KX

30 mm push buttons

9001K – Specialty operators

Note: When ordering, add prefix “9001” to the reference.



Without Latch

Joy Stick Operators—UL Types 4, 13/NEMA 4, 13. For use in hazardous locations, see page 23. Contact blocks and legend plate not included unless noted.

Description	Operator With Contacts	Operator Without Contacts (1)
↕ 3-Position— Center Off	Momentary Contact— Without Latch	K71H7
	Spring Return to Center With Latch	K70H7
	Maintained Contact Without Latch	K73H7
↔ 3-Position— Center Off	Momentary Contact— Without Latch	K31H8
	Spring Return to Center With Latch	K30H8
	Maintained Contact Without Latch	K33H8
⬠ 5 Position— Center Off	Momentary Contact— Without Latch	K35H2
	Spring Return to Center With Latch	K34H2
	Maintained Contact Without Latch	K37H2
	With Latch	K36H2

(1) These operators can be ordered complete with contact blocks—a total of four (4) contact blocks can be used. Add the “H” number chosen from page 21 to the operator reference number and add the cost of the “H” number to the operator cost.



With Latch

Contact Arrangements

Operator Positions	Contact Block Reference	Contact Block Location	Contact Handle position (with reference to Nib)					
			1 ↑	2 →	OFF	3 ↓	4 ←	
↔	K3	POS 1 (3)	A	—	1	0	—	0
	KA3	POS 2 (4)	A	—	0	0	—	1
↕	KA2	POS 1 (3)	B	1	—	0	0	—
	KA2	POS 2 (4)	B	0	—	0	1	—
⬠	KA1	POS 1 (3)	A	0	1	0	0	0
			B	1	0	0	0	0
	KA1	POS 2 (4)	A	0	0	0	0	1
			B	0	0	0	1	0

The joy stick operator is ideal for applications where only one circuit is to be energized at one time. The three position joy stick closes one circuit in each Up-Down or Right-Left position with all circuits open in center position. The five position operator closes one circuit in each Up, Down, Left and Right position with all circuits open in center position.

Momentary contact operators are spring return to the center position. Maintained operators remain in position and must be returned manually. Operators with latch cannot be operated until the latch button in center of handle is pressed.

(1) Contact Closed (0) Contact Open

For use in hazardous locations, see page 23. Legend plate and contact block not included. Inserts are field convertible. For colors not listed, order operator without insert, plus separate color insert from page 28. Up to two 9001KA contact blocks can be mounted in tandem (total of four blocks). Selector push buttons cannot be illuminated.



Selector Push Button 9001KQ

Selector Push Button Operators—UL Types 4, 13/NEMA 4, 13

Contact Block Required (4)	Mount on Side	Two Position Operators											
		0—Contact Open				1—Contact Closed				F—Free D—Depressed			
Quantity and Type		Left		Right		Left		Right		Left		Right	
		F	D	F	D	F	D	F	D	F	D	F	D
1 KA1 	#2	0	0	1	0	0	0	1	0	0	0	1	1
		0	1	0	1	0	1	0	0	0	0	0	1
1 KA1 	#1	0	0	1	1	0	0	1	0	1	1	1	0
		0	1	0	0	0	1	0	0	0	0	1	0
Cam (3)		P				R				S			
Color Insert		Reference				Reference				Reference			
Without Insert (2) Black		KQ11				KQ12				KQ13			
		KQ11B				KQ12B				KQ13B			
		KQ14B				KQ15B							

(2) Order color inserts from page 28.
 (3) Cams are not interchangeable.
 (4) To order Contact Blocks, see pages 20 to 23.

For use in hazardous locations, see page 23. Key operated push buttons are used wherever unauthorized use of a push button is discouraged. Examples are locking a Start push button in the extended position or locking a Stop push button in the depressed position. The operator can also be locked in the flush position—holding all contacts open. Up to two 9001KA contact blocks can be mounted in tandem (total of four blocks). Legend Plate and Contact Block Not Included (“x” = locked position).



Key Operated Push Button 9001KR

Key Operated Push Button – UL Types 4, 13/NEMA 4, 13

Description	Lockable Positions			Reference
	Extended	Flush	Depressed	
Push button operable only with key in lock. Key is removable in locked position only.	x	—	—	KR131 KR132 KR133 KR137
Push button operable with or without key in lock. Push button can be locked with key only. Key removable in both locked or unlocked position.	x	—	—	KR141 KR142 KR143 KR147
To lock the unit, rotate the key with the button in the extended position. Then, push the button to lock it in the position indicated at right. Key is removable only in this position.	—	x	—	KR152 KR153

Note: All key operated push buttons are furnished as standard with Square D no. E10 key change. See catalog 9001CT0001 for other key changes.

Harmony™ 9001K/SK/KX

30 mm push buttons

9001K – Specialty operators

Note: When ordering, add prefix “9001” to the reference.

Illuminated and Non-Illuminated Dual Operators

Meets UL Type 13/NEMA 13 and UL Type 6/NEMA 6, which UL and NEMA consider an equivalent to UL Type 4/NEMA 4. For use in hazardous locations, see page 23. Legend plate and contact blocks not included unless otherwise noted.



9001KR7U



9001KR11U

Description	Color	With 2 N.O. Contacts (2 KA2)	With 1 N.O. & 1 N.C. Contact (KA2, KA3)	Without Contacts
Momentary Dual Function	Universal (1)	KR6UH7	KR6UH37	KR6U
	Green-Red	KR6GRH7	KR6GRH37	KR6GR
	Other (2)	KR6■H7	KR6■H37	KR6■
Momentary Interlocked Dual Function	Universal (1)	KR67UH7	KR67UH37	KR67U
	Green-Red	KR67GRH7	KR67GRH37	KR67GR
	Other (2)	KR67■H7	KR67■H37	KR67■
Maintained Interlocked Dual Function	Universal (1)	KR7UH7	KR7UH37	KR7U
	Green-Red	KR7GRH7	KR7GRH37	KR7GR
	Other (2)	KR7■H7	KR7■H37	KR7■
Description	Color	Contacts (KA1)		Without Contacts
Both Buttons Maintained Interlocked Assembly	Universal (3)	—		KR11U
	Other (4)	—		KR11★
One Button Momentary One Button Maintained Interlocked Assembly	Universal (3)	—		KR12U
	Other (4)	—		KR12★

(1) Universal for KR6, KR67, KR7 includes 2 inserts each of black, red and green.
 (2) Replace ■ with one color for each button. R = red, G = green, B = Black. Example: A KR6 with left button red and right button black = KR6RB
 (3) Universal for KR11, KR12 includes 2 each of black, red, green, yellow, orange, blue, white.
 (4) Replace ★ with one color for each button. B = black, R = red, G = green, L = blue, Y = yellow, W = white, S = orange, E = gray.
 Example: A KR11 with top button gray and bottom button orange = KR11ES



Emergency Break-Glass Operator 9001K15

Emergency Break-Glass Operator—UL 4, 13/NEMA 4, 13

Reference
K15

Operator is held in a depressed position by a glass disc. When the glass disc is broken with the hammer, button returns to a normal extended position. Package of 5 discs included with operator.

9001K15 Replacement Parts

Description	Reference
Yellow bumper	3105211101
Hammer and chain	3105206750
Lower ring nut	6512232801
Top ring nut	9001K40
Package of 5 replacement discs	9001K57
Clip to hold hammer	2540902240



Rocker Arm Operating Lever 9001K50

Rocker Arm Operating Lever

Reference
K50

Allows two standard push buttons to be operated independently of each other. Order push buttons and legend plates from pages 10, 11, 25, and 26 (please specify which marking is to be inverted).

Alternate Action—Push-on, Push-off Module

Reference
K85



Push-on Push-off Module 9001K85

This module can be added to standard 9001K, 9001KX, 9001SK or 9001T momentary push button operators. Contact blocks mounted behind this module (maximum of 2) are held in the depressed position when the operator is pressed once, and released to their normal position when the operator is pressed again. For a N.C. circuit, use a 9001KA3 or the N.C. contact of either a 9001KA1 or 9001KA4. For a N.O. circuit, use the N.O. contact of either a 9001KA4 or 9001KA6.



Wobble stick

For easy operation of any standard push button.

Reference
K8



Time Delay Push Button 9001KRD

Time Delay Push Button—UL Types 4, 13/NEMA 4, 13

Description (Off - Delay)	Reference (All Colors)		
	Full Guard	Extended Guard	No Guard
 Timed Contact 1 N.O. and 1 N.C.	KRD1UH1	KRD2UH1	KRD3UH1
 Timed Contact 2 N.O. and 2 N.C.	KRD1UH2	KRD2UH2	KRD3UH2

Timing period is adjustable from 0.1 second to 60 seconds and begins after button has been released. Devices include a pack of seven color inserts for color coding the push button. See page 28 for Universal color insert. Contacts are quick make-quick break. Note: When mounted in top or bottom hole of a 9001K enclosure, device requires one additional space below or above operator. When mounted other than in top or bottom hole, device may require two additional spaces, one above and one below operator. Closing plates must be installed on unused holes.

Harmony™ 9001K/SK/KX

30 mm push buttons

9001K – Contact blocks

Note: When ordering, add prefix “9001” to the reference.

The 9001KA contact blocks are Fingersafe™ contact blocks (meeting VDE 0106 Part 100). They have one screw mounting and captive (backed out) plus/minus terminal screws. These contact blocks are double-break, direct-acting contacts. Because of the wiping action of these contacts, they are suitable for use with programmable controllers. All contact blocks listed below accept up to 2 #12–#24 AWG solid or stranded wires. Recommended tightening torque for screw terminals is 7 lb-in

Standard Contact Blocks

Description	Symbol	Reference
(Clear Cover)	 Direct-Acting	KA1
(Green Cover)		KA2
(Red Cover)	 Direct-Acting	KA3
(Clear Cover)	 N.O. Contact Early Closing	KA4
(Red Cover)	 N.C. Contact Late Opening	KA5
(Green Cover)	 N.O. Contact Early Closing	KA6

Additional Circuit Arrangements

Sequencing (1) N.O. Contact of KA4 closes before N.O. Contact on KA1		Order One9001KA4 and One 9001KA1
Overlapping (1) N.O. Contact of KA4 closes before N.C. Contact of KA5 Opens		Order One9001KA4 and One 9001KA5

(1) For push buttons or two-position selector switches only. For sequencing or overlapping contacts on other operators, refer to catalog 9001CT0001.

Symbol	Contact Blocks with Binder Head Screws (not Fingersafe) Reference	Quantity (2)	Gold Flashed Contacts with Standard Pressure Wire Terminals Reference
	KA21	25–Up	KA31
	KA22	25–Up	KA32
	KA23	25–Up	KA33
 N.O. Early Closing	KA24	25–Up	KA34
 N.C. Contact Late Opening	KA25	25–Up	KA35

(2) Minimum order quantity is 25.

Contact blocks listed below are not Fingersafe, but provide:

- Terminals that accept ring tongue/fork tongue connectors
- Short single circuit contact blocks (0.75” deep vs. 0.97” deep on the Fingersafe)
- For assembled operators, use form Y238 (add to reference as suffix, for example: 9001KRU1H13Y238)

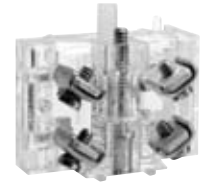

Contact blocks (not Fingersafe)

Symbol	Reference	Symbol	Reference
	KA1G	 N.O. Contact Early Closing	KA4G
	KA2G	 N.C. Contact Late Opening	KA5G
	KA3G	 N.O. Contact Early Closing	KA6G

Contact blocks with Quick-Connect terminals (not Fingersafe)

Symbol	Reference
	KA12
	KA13

For dimensions, refer to catalog 9001CT0001

Maximum Current Ratings for Control Circuit Contacts—9001KA1–KA6, KA21–KA25, KA31–KA35, KA1G–KA6G

V	AC						V	DC				
	Inductive (NEMA / UL Type A600) 35% Power Factor					Resistive 75% Power Factor Make, Break and Continuous Amperes		Inductive and Resistive (NEMA Q600)				
	Make		Break		Continuous Carrying Amperes			Make and Break				
	Amperes	VA	Amperes	VA				KA1	KA2 KA3	KA4	KA5 KA6	Continuous Carrying Amperes
120	60	7200	6.0	720	10	10	125	0.55	0.55	—	—	2.5
240	30		250				0.27	0.27	—	—		
480	15		600				0.10	0.10	—	—		
600	12											

To select and order Contact Blocks, Light Modules, Knobs, and Accessories, see pages 50 to 59.

Harmony™ 9001K/SK/KX

30 mm push buttons

9001K – Contact blocks

Note: When ordering, add prefix “9001” to the reference.

Contact Block “H” Codes

The design of the 9001KA contact blocks allows them to be mounted side by side and/or in tandem. This enables you to specify an operator and a particular arrangement of contact blocks (shipped completely assembled) with a single reference number. See page 20 for a description of contact blocks.



Example: A 9001KR1B push button with 2 9001KA1 contact blocks would be 9001KR1BH2.

Suffix No. (Add to Operator Reference)	Positions					
	1	2	3	4	5	6
H1	KA1					
H2	KA1	KA1				
H3	KA1	KA1	KA1			
H4	KA1	KA1	KA1	KA1		
H5	KA2					
H6	KA3					
H7	KA2	KA2				
H8	KA3	KA3				
H9	KA4	KA1				
H10	KA4	KA5				
H11	KA1	KA1		KA1		
H12	KA2	KA3	KA2	KA3		
H13		KA1				
H14		KA3				
H15	KA2	KA3	KA2			
H16	KA2	KA3		KA3		
H17	KA1	KA1	KA2			
H18	KA3	KA1	KA3		KA3	
H19	KA1	KA1	KA1	KA1	KA1	
H21	KA2	KA3				
H23	KA1	KA1	KA1	KA1	KA1	KA1
H24	KA1	KA2				
H25	KA5	KA3				

Note: For “H” Codes not shown in this table, contact your local Schneider Electric representative.

Dimensions When Using Contact Blocks



Maximum Contact Block Usage:

- 2 blocks mounted side by side only:** Any 2, 3 or 4-Position spring return selector switch (non-illuminated, illuminated or keyed).
- 2 blocks mounted in tandem on one side only:** Any 2 operator interlocked push button.
- 2 blocks mounted in tandem (total of four blocks):** Any selector push button, keyed push button, 2, 3, or 4-Position maintained selector switch (non-illuminated, illuminated or keyed), push pull operators (non-illuminated or illuminated), joy stick, dual push button.
- 3 blocks mounted in tandem (total of six blocks):** Single momentary push buttons (non-illuminated or illuminated).

Harmony™ 9001K/SK/KX

30 mm push buttons

9001K – Contact blocks

Note: When ordering, add prefix “9001” to the reference.

Mounting Hole for All 9001K, -SK, and -KX Control Units



Hole Punch: Use Greenlee Tool #60242 to punch mounting hole and notch.

Maximum Contact Block Usage:

- **2 blocks mounted side by side only:** Any 2, 3 or 4-Position **spring return** selector switch (non-illuminated, illuminated or keyed).
- **2 blocks mounted in tandem on one side only:** Any 2 operator interlocked push button.
- **2 blocks mounted in tandem (total of four blocks):** Any selector push button, keyed push button, 2, 3, or 4-Position **maintained** selector switch (non-illuminated, illuminated or keyed), push-pull operators (non-illuminated or illuminated), joy stick, dual push button.
- **3 blocks mounted in tandem (total of six blocks):** Single momentary push buttons (non-illuminated or illuminated).

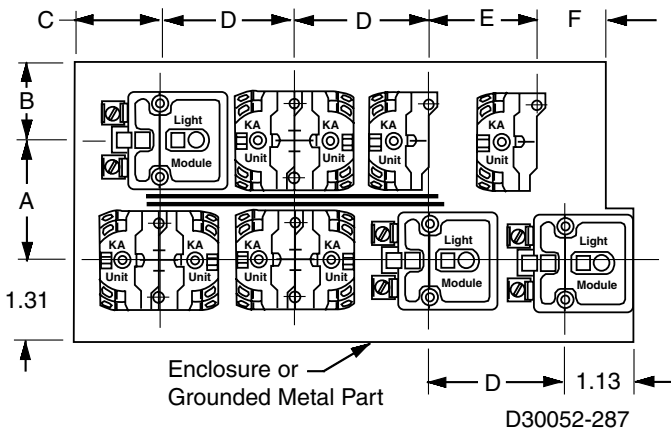

Min. Centerline Spacing, 9001K Control Units

Legend Plate	Operator	Centerline Spacing (in)					
		A	B	C	D	E	F
Legend Plate Orientation Position #1							
KN2	Standard Push Button	1.75	1.31	1.44	2.25	1.69	0.88
	1.375 in Dia. Mushroom	1.75	1.31	1.44	2.25	1.69	0.88
	2.25 in Dia. Mushroom	2.25	1.31	1.44	2.25	2.25	1.12
	Selector Switch Knobs	1.75	1.31	1.44	2.25	1.69	0.88
KN3	Standard Push Button	2.00	1.31	1.44	2.25	1.75	0.88
	1.375 in Dia. Mushroom	2.00	1.31	1.44	2.25	1.75	0.88
	2.25 in Dia. Mushroom	2.25	1.31	1.44	2.25	2.25	1.12
	Selector Switch Knobs	2.00	1.31	1.44	2.25	1.75	0.88
KN4	Standard Push Button	1.94	1.31	1.44	2.25	1.62	0.88
	1.375 in Dia. Mushroom	1.94	1.31	1.44	2.25	1.62	0.88
	2.25 in Dia. Mushroom	2.25	1.31	1.44	2.25	2.25	1.12
	Selector Switch Knobs	1.74	1.31	1.44	2.25	1.62	0.88
KN6	Standard Push Button	2.38	1.62	1.44	2.25	2.25	1.12
	1.375 in Dia. Mushroom	2.38	1.62	1.44	2.25	2.25	1.12
	2.25 in Dia. Mushroom	2.38	1.62	1.44	2.25	2.25	1.12
	Selector Switch Knobs	2.38	1.62	1.44	2.25	2.25	1.12

Legend Plate	Operator	Centerline Spacing (in)					
		A	B	C	D	E	F
Legend Plate Orientation Position #2							
KN2	Standard Push Button	1.62	1.31	1.44	2.25	1.75	0.88
	1.375 in Dia. Mushroom	1.62	1.31	1.44	2.25	1.75	0.88
	2.25 in Dia. Mushroom	2.25	1.31	1.44	2.25	2.25	1.12
	Selector Switch Knobs	1.62	1.31	1.44	2.25	1.75	0.88
KN3	Standard Push Button	1.75	1.31	1.44	2.25	2.00	0.88
	1.375 in Dia. Mushroom	1.75	1.31	1.44	2.25	2.00	0.88
	2.25 in Dia. Mushroom	2.25	1.31	1.44	2.25	2.25	1.12
	Selector Switch Knobs	1.75	1.31	1.44	2.25	2.00	0.88
KN4	Standard Push Button	1.62	1.31	1.44	2.25	1.94	1.00
	1.375 in Dia. Mushroom	1.62	1.31	1.44	2.25	1.94	1.00
	2.25 in Dia. Mushroom	2.25	1.31	1.44	2.25	2.25	1.12
	Selector Switch Knobs	1.62	1.31	1.44	2.25	1.94	1.00
KN6	Standard Push Button	2.25	1.31	1.62	2.38	2.38	0.88
	1.375 in Dia. Mushroom	2.25	1.31	1.62	2.38	2.38	0.88
	2.25 in Dia. Mushroom	2.25	1.31	1.62	2.38	2.38	1.12
	Selector Switch Knobs	2.25	1.31	1.62	2.38	2.38	0.88

Harmony™ 9001K/SK/KX

30 mm push buttons

9001K – Contact blocks

Note: When ordering, add prefix “9001” to the reference.

Hazardous locations do not always require the use of explosion-proof equipment like the 9001BR control stations. Selecting the most appropriate device for the location can save you money. For more information on the types of hazardous locations, contact your local electrical inspector.

Schneider Electric Offering According to Class, Division, and Group

For Class	Division	Group(s)	Use
I	1	A	1. Intrinsically Safe System
I	1	B, C, D	1. 9001BR station 2. Intrinsically Safe System
I	2	A	1. 9001K control stations with restrictions (1) 2. Intrinsically Safe System
I	2	B, C, D	1. 9001BR station 2. 9001K control stations with restrictions (1) 3. Intrinsically Safe System
II	1	E, F, G	1. 9001BR station 2. Intrinsically Safe System
II	2	E, F	1. 9001BR station 2. 9001K control stations with restrictions (1) 3. Intrinsically Safe System
II	2	G	1. 9001BR station 2. 9001K control stations with restrictions (2) 3. Intrinsically Safe System
III	1, 2	—	1. 9001BR Station 2. 9001K control stations with restrictions (2) 3. Intrinsically Safe System

Any 9001K operator can be used in an area classified as Class I, Division 2 hazardous locations, if:

- Only logic (KA40 series) or power (KA50 series) reed contact blocks are used.
- All 9001K illuminated operators are UL approved for use in Class I Division 2 areas.
- The operators are mounted in any NEMA 4 & 13 enclosures.

(1) Any 9001K operator mounted in a 9001KY, 9001KYSS, 9001KYAF or 9001SKY enclosure may be used, except potentiometer operators.

(2) Add Form Y243 to single lamp Push-To-Test pilot lights.

Note: For (1) and (2): UL Listed: File E10054(N), CCN NOIV.

Hazardous Locations:



File E10054(N)
CCN NOIV



File LR26817
Class 3218 02

Hermetically Sealed Logic Reed Contact Blocks Suitable for use on low energy level circuits

Description	Symbol	Reference
		KA41
		KA42
		KA43
		KA44
		KA45

Max. Vac/Vdc	Maximum Load		
	Resistive	Inductive	Continuous
32/30	.25 A	.10 A	.5 A
120/100	8 VA	3 VA	.5 A

The maximum number of logic and/or power reed contact blocks per operator is as indicated on individual selection tables for standard contact blocks, **except**:

- On 3-Position selector switches with cams C, D, E, F, G, L, or M, mount reed blocks on **one side only** (either side), maximum 2 in tandem.
- On 4-Position selector switches, mount reed blocks on **one side only** (either side), maximum 2 in tandem.
- On joysticks or on 9001KR8 push-pull operators, mount reed blocks on **one side only** (either side), maximum 2 in tandem.

Hermetically Sealed Power Reed Contact Blocks (5)

Description	Symbol	Reference
		KA51
		KA52
		KA53
		KA54
		KA55

Volts	AC NEMA C300 (3)				Continuous Carrying Amperes
	Make		Break		
	A	VA	A	VA	
120	10.00	1200	1.000	120	3.0
240	5.00		.500		

Volts	DC NEMA Q150 (4)				Continuous Carrying Amperes
	Make		Break		
	A	VA	A	VA	
115	.50	58	.50	58	3.0

Note: All contact blocks listed above except #12–18 solid or stranded wire.

The power reed contact blocks can be used with standard industrial relays and starters through NEMA Size 4. Minimum voltage is 5 V and the minimum current is 1 mA.

(3) Inductive Rating—35% Power Factor.

(4) Inductive and Resistive Ratings

(5) Not for use in pendant stations.

Harmony™ 9001K/SK/KX

30 mm push buttons

9001K – Light modules

Note: When ordering, add prefix “9001” to the reference.



Standard Light Modules for 9001K Control Units (1)					
Voltage	Description	Light Module Reference	Voltage Assembly Code	Rating	Replacement Lamp Reference
All	Full Voltage (without Bayonet Base Lamp)	KM40	40	—	no lamp included
6 Vac/Vdc	Full Voltage	KM31	31	.9 VA	2550101020
6 Vac/Vdc	LED Red	KM31LR	31LR		6508805201
6 Vac/Vdc	LED Green	KM31LG	31LG		6508805203
6 Vac/Vdc	LED Yellow	KM31LY	31LY		6508805202
12–14 Vac/Vdc	Full Voltage	KM32	32	1.2 VA	2550101037
12–14 Vac/Vdc	LED Red	KM32LR	32LR		6508805201
12–14 Vac/Vdc	LED Green	KM32LG	32LG		6508805203
12–14 Vac/Vdc	LED Yellow	KM32LY	32LY		6508805202
18 Vac/Vdc	Resistor	KM33	33	1.4 VA	2550101037
24–28 Vac/Vdc	Full Voltage	KM35	35	1.2 VA	2550101002
24–28 Vac/Vdc	LED Red	KM35LR	35LR	.28 VA	6508805210
24–28 Vac/Vdc	LED Green	KM35LG	35LG	.28 VA	6508805212
24–28 Vac/Vdc	LED Yellow	KM35LY	35LY	.28 VA	6508805211
24–28 Vac/Vdc	LED White	KM35LW	35LW	.28 VA	6508805214
24–28 Vac/Vdc	LED Blue	KM35LL	35LL	.28 VA	6508805213
48 Vac/Vdc	Full Voltage	KM36	36	2.6 VA	2550101025
110–120 V, 50–60 Hz	LED Red	KM1LR	1LR		6508805201
110–120 V, 50–60 Hz	LED Green	KM1LG	1LG		6508805203
110–120 V, 50–60 Hz	LED Yellow	KM1LY	1LY		6508805202
110–120 V, 50–60 Hz	Transformer	KM1	1	2.4 VA	2550101020
110–120 V, 50–60 Hz	Flashing	KMF1	F1	.85 VA	2550101036
120 Vac/Vdc	Resistor	KM38	38	3.0 VA	2550101027
120 Vac/Vdc	Full Voltage	KM38	38	3.0 VA	2550101027
120 Vac/Vdc	Neon	KM11	11	0.2 VA	2550101013
120 Vac/Vdc	LED Red	KM38LR	38LR	1.4 VA	6508805210
120 Vac/Vdc	LED Green	KM38LG	38LG	1.4 VA	6508805212
120 Vac/Vdc	LED Yellow	KM38LY	38LY	1.4 VA	6508805211
120 Vac/Vdc	LED White	KM38LW	38LW	1.4 VA	6508805214
120 Vac/Vdc	LED Blue	KM38LL	38LL	1.4 VA	6508805213
208–220 V, 50–60 Hz	Transformer	KM3	3	2.5 VA	2550101020
208–220 V, 50–60 Hz	LED Red	KM3LR	3LR		6508805201
208–220 V, 50–60 Hz	LED Green	KM3LG	3LG		6508805203
208–220 V, 50–60 Hz	LED Yellow	KM3LY	3LY		6508805202
208–220 V, 50–60 Hz	LED White	KM3LW	3LW		6508805215
208–220 V, 50–60 Hz	LED Blue	KM3LL	3LL		6508805216
220–240 V, 50–60 Hz	Transformer	KM7	7	2.0 VA	2550101020
220–240 V, 50–60 Hz	LED Red	KM7LR	7LR		6508805201
220–240 V, 50–60 Hz	LED Green	KM7LG	7LG		6508805203
220–240 V, 50–60 Hz	LED Yellow	KM7LY	7LY		6508805202
220–240 V, 50–60 Hz	LED White	KM7LW	7LW		6508805215
220–240 V, 50–60 Hz	LED Blue	KM7LL	7LL		6508805216
240 Vac/Vdc	Resistor	KM25	25	6.0 VA	2550101027
240 Vac/Vdc	Neon	KM12	12	0.3 VA	2550101013
277 V, 50–60 Hz	Transformer	KM8	8	2.4 VA	2550101020
380–480 V, 50–60 Hz	Transformer	KM5	5	2.8 VA	2550101020
480 Vac/Vdc	Neon	KM14	14	0.5 VA	2550101013
550–600 V, 50–60 Hz	Transformer	KM6	6	2.5 VA	2550101020

(1) For use with all operators except KX and remote test pilot.

Notes: Light modules are available in other voltages, as shown above. For use in hazardous locations, see page 23. With neon type light modules, use a clear color cap only. With LED light modules, use either a clear color cap or a cap the same color as the LED.



Shallow Depth Light Modules for 9001K Control Units (2)					
Voltage	Description	Light Module Reference	Voltage Assembly Code	Rating	Replacement Lamp Reference
24–28 Vac/Vdc	Full Voltage	KM55	55	1.2 VA	2550101002
	LED Red	KM55LR	55LR	0.5 VA	6508805204
	LED Green	KM55LG	55LG		6508805206
	LED Yellow	KM55LY	55LY		6508805205
110–120 Vac/Vdc	Full Voltage	KM58	58	3.0 VA	2550101027
	LED Red	KM58LR	58LR	0.5 VA	6508805204
	LED Green	KM58LG	58LG		6508805206
	LED Yellow	KM58LY	58LY		6508805205

(2) For use with all operators except KX and remote test pilot.

Notes: For use in hazardous locations, see page 23. Reduces the depth of illuminated push buttons with contact blocks by over 33%. With LED light modules, use a cap that is the same color as the LED.



File
CCN

E42259
NKCR



File
Class LR25490
3211 03



marked

Harmony™ 9001K/SK/KX

30 mm push buttons

9001K – Legend plates

Note: When ordering, add prefix “9001” to the reference.

Legend Plates												
Standard Markings	Plastic Legend Plates for use with 9001K Operators									Aluminum Legend Plates for use with 9001K Operators		
	1-3/4" Square			2-1/4" Square			2-1/2" Square			Black Legend	Black Legend	Blue Legend
	Silver Legend w/ Black Letters	White Legend w/ Black Letters	Black Legend w/ White Letters	Silver Legend w/ Black Letters	White Legend w/ Black Letters	Black Legend w/ White Letters	Silver Legend w/ Black Letters	White Legend w/ Black Letters	Black Legend w/ White Letters			
For Push Button or Pilot Light												
Blank	KN200SP	KN200WP	KN200BP	KN100SP	KN100WP	KN100BP	KN700SP	KN700WP	KN700BP	KN200	KN300	KN800
Blank (red)	KN200RP (2)	KN200RP (2)	KN200RP (2)	KN100RP (2)	KN100RP (2)	KN100RP (2)	KN700RP (2)	KN700RP (2)	KN700RP (2)	KN200R (1)	KN300R (1)	KN800R (1)
Start	KN201SP	KN201WP	KN201BP	KN101SP	KN101WP	KN101BP	KN701SP	KN701WP	KN701BP	KN201	KN301	KN801
Stop	KN202RP (2)	KN202RP (2)	KN202RP (2)	KN102RP (2)	KN102RP (2)	KN102RP (2)	KN702RP (2)	KN702RP (2)	KN702RP (2)	KN202 (1)	KN302 (1)	KN802 (1)
On	KN203SP	KN203WP	KN203BP	KN103SP	KN103WP	KN103BP	KN703SP	KN703WP	KN703BP	KN203	KN303	KN803
Off	KN204RP (2)	KN204RP (2)	KN204RP (2)	KN104RP (2)	KN104RP (2)	KN104RP (2)	KN704RP (2)	KN704RP (2)	KN704RP (2)	KN204 (1)	KN304 (1)	KN804 (1)
Emerg. Stop	KN205RP (2)	KN205RP (2)	KN205RP (2)	KN105RP (2)	KN105RP (2)	KN105RP (2)	KN705RP (2)	KN705RP (2)	KN705RP (2)	KN205 (1)	KN305 (1)	KN805 (1)
Forward	KN206SP	KN206WP	KN206BP	KN106SP	KN106WP	KN106BP	KN706SP	KN706WP	KN706BP	KN206	KN306	KN806
Reverse	KN207SP	KN207WP	KN207BP	KN107SP	KN107WP	KN107BP	KN707SP	KN707WP	KN707BP	KN207	KN307	KN807
Close	KN208SP	KN208WP	KN208BP	KN108SP	KN108WP	KN108BP	KN708SP	KN708WP	KN708BP	KN208	KN308	KN808
Open	KN209SP	KN209WP	KN209BP	KN109SP	KN109WP	KN109BP	KN709SP	KN709WP	KN709BP	KN209	KN309	KN809
Down	KN210SP	KN210WP	KN210BP	KN110SP	KN110WP	KN110BP	KN710SP	KN710WP	KN710BP	KN210	KN310	KN810
Up	KN211SP	KN211WP	KN211BP	KN111SP	KN111WP	KN111BP	KN711SP	KN711WP	KN711BP	KN211	KN311	KN811
Fast	KN212SP	KN212WP	KN212BP	KN112SP	KN112WP	KN112BP	KN712SP	KN712WP	KN712BP	KN212	KN312	KN812
Slow	KN213SP	KN213WP	KN213BP	KN113SP	KN113WP	KN113BP	KN713SP	KN713WP	KN713BP	KN213	KN313	KN813
High	KN214SP	KN214WP	KN214BP	KN114SP	KN114WP	KN114BP	KN714SP	KN714WP	KN714BP	KN214	KN314	KN814
Low	KN215SP	KN215WP	KN215BP	KN115SP	KN115WP	KN115BP	KN715SP	KN715WP	KN715BP	KN215	KN315	KN815
Inch	KN216SP	KN216WP	KN216BP	KN116SP	KN116WP	KN116BP	KN716SP	KN716WP	KN716BP	KN216	KN316	KN816
In	KN217SP	KN217WP	KN217BP	KN117SP	KN117WP	KN117BP	KN717SP	KN717WP	KN717BP	KN217	KN317	KN817
Jog	KN218SP	KN218WP	KN218BP	KN118SP	KN118WP	KN118BP	KN718SP	KN718WP	KN718BP	KN218	KN318	KN818
Jog For.	KN219SP	KN219WP	KN219BP	KN119SP	KN119WP	KN119BP	KN719SP	KN719WP	KN719BP	KN219	KN319	KN819
Jog Rev.	KN220SP	KN220WP	KN220BP	KN120SP	KN120WP	KN120BP	KN720SP	KN720WP	KN720BP	KN220	KN320	KN820
Lower	KN221SP	KN221WP	KN221BP	KN121SP	KN121WP	KN121BP	KN721SP	KN721WP	KN721BP	KN221	KN321	KN821
Out	KN222SP	KN222WP	KN222BP	KN122SP	KN122WP	KN122BP	KN722SP	KN722WP	KN722BP	KN222	KN322	KN822
Reset	KN223SP	KN223WP	KN223BP	KN123SP	KN123WP	KN123BP	KN723SP	KN723WP	KN723BP	KN223	KN323	KN823
Run	KN224SP	KN224WP	KN224BP	KN124SP	KN124WP	KN124BP	KN724SP	KN724WP	KN724BP	KN224	KN324	KN824
Start Jog	KN225SP	KN225WP	KN225BP	KN125SP	KN125WP	KN125BP	KN725SP	KN725WP	KN725BP	KN225	KN325	KN825
Test	KN226SP	KN226WP	KN226BP	KN126SP	KN126WP	KN126BP	KN726SP	KN726WP	KN726BP	KN226	KN326	KN826
Raise	KN227SP	KN227WP	KN227BP	KN127SP	KN127WP	KN127BP	KN727SP	KN727WP	KN727BP	KN227	KN327	KN827
Decrease	KN228SP	KN228WP	KN228BP	KN128SP	KN128WP	KN128BP	KN728SP	KN728WP	KN728BP	KN228	KN328	KN828
Increase	KN229SP	KN229WP	KN229BP	KN129SP	KN129WP	KN129BP	KN729SP	KN729WP	KN729BP	KN229	KN329	KN829
Left	KN230SP	KN230WP	KN230BP	KN130SP	KN130WP	KN130BP	KN730SP	KN730WP	KN730BP	KN230	KN330	KN830
Right	KN231SP	KN231WP	KN231BP	KN131SP	KN131WP	KN131BP	KN731SP	KN731WP	KN731BP	KN231	KN331	KN831
Cycle Start	KN232SP	KN232WP	KN232BP	KN132SP	KN132WP	KN132BP	KN732SP	KN732WP	KN732BP	KN232	KN332	KN832
Feed Start	KN233SP	KN233WP	KN233BP	KN133SP	KN133WP	KN133BP	KN733SP	KN733WP	KN733BP	KN233	KN333	KN833
Cycle Stop	KN234SP	KN234WP	KN234BP	KN134SP	KN134WP	KN134BP	KN734SP	KN734WP	KN734BP	KN234	KN334	KN834
Motor Run	KN236SP	KN236WP	KN236BP	KN136SP	KN136WP	KN136BP	KN736SP	KN736WP	KN736BP	KN236	KN336	KN836
Motor Stop	KN237SP	KN237WP	KN237BP	KN137SP	KN137WP	KN137BP	KN737SP	KN737WP	KN737BP	KN237	KN337	KN837
Power On	KN238SP	KN238WP	KN238BP	KN138SP	KN138WP	KN138BP	KN738SP	KN738WP	KN738BP	KN238	KN338	KN838
Pull To Start	N/A	N/A	N/A	KN179SP	KN179WP	KN179BP	KN779SP	KN779WP	KN779BP	N/A	KN379	N/A
Push To Stop												
For Selector Switch or Selector Push Button												
For.-Rev.	KN239SP	KN239WP	KN239BP	KN139SP	KN139WP	KN139BP	KN739SP	KN739WP	KN739BP	KN239	KN339	KN839
Hand-Auto.	KN240SP	KN240WP	KN240BP	KN140SP	KN140WP	KN140BP	KN740SP	KN740WP	KN740BP	KN240	KN340	KN840
High-Low	KN241SP	KN241WP	KN241BP	KN141SP	KN141WP	KN141BP	KN741SP	KN741WP	KN741BP	KN241	KN341	KN841
Jog-Run	KN242SP	KN242WP	KN242BP	KN142SP	KN142WP	KN142BP	KN742SP	KN742WP	KN742BP	KN242	KN342	KN842
Man.-Auto.	KN243SP	KN243WP	KN243BP	KN143SP	KN143WP	KN143BP	KN743SP	KN743WP	KN743BP	KN243	KN343	KN843
Off-On	KN244SP	KN244WP	KN244BP	KN144SP	KN144WP	KN144BP	KN744SP	KN744WP	KN744BP	KN244	KN344	KN844
On-Off	KN245SP	KN245WP	KN245BP	KN145SP	KN145WP	KN145BP	KN745SP	KN745WP	KN745BP	KN245	KN345	KN845
Open-Close	KN246SP	KN246WP	KN246BP	KN146SP	KN146WP	KN146BP	KN746SP	KN746WP	KN746BP	KN246	KN346	KN846
Raise-Lower	KN247SP	KN247WP	KN247BP	KN147SP	KN147WP	KN147BP	KN747SP	KN747WP	KN747BP	KN247	KN347	KN847
Run-Jog	KN248SP	KN248WP	KN248BP	KN148SP	KN148WP	KN148BP	KN748SP	KN748WP	KN748BP	KN248	KN348	KN848
Slow-Fast	KN250SP	KN250WP	KN250BP	KN150SP	KN150WP	KN150BP	KN750SP	KN750WP	KN750BP	KN250	KN350	KN850
Start-Stop	KN251SP	KN251WP	KN251BP	KN151SP	KN151WP	KN151BP	KN751SP	KN751WP	KN751BP	KN251	KN351	KN851
Up-Down	KN253SP	KN253WP	KN253BP	KN153SP	KN153WP	KN153BP	KN753SP	KN753WP	KN753BP	KN253	KN353	KN853
Low-High	KN254SP	KN254WP	KN254BP	KN154SP	KN154WP	KN154BP	KN754SP	KN754WP	KN754BP	KN254	KN354	KN854
Stop-Start	KN255SP	KN255WP	KN255BP	KN155SP	KN155WP	KN155BP	KN755SP	KN755WP	KN755BP	KN255	KN355	KN855
Left-Right	KN256SP	KN256WP	KN256BP	KN156SP	KN156WP	KN156BP	KN756SP	KN756WP	KN756BP	KN256	KN356	KN856
On-Auto	KN276SP	KN276WP	KN276BP	KN176SP	KN176WP	KN176BP	KN776SP	KN776WP	KN776BP	KN276	KN376	KN876
Auto-Off-Hand	KN258SP	KN258WP	KN258BP	KN158SP	KN158WP	KN158BP	KN758SP	KN758WP	KN758BP	KN258	KN358	KN858
For.-Off-Rev.	KN259SP	KN259WP	KN259BP	KN159SP	KN159WP	KN159BP	KN759SP	KN759WP	KN759BP	KN259	KN359	KN859
Hand-Off-Auto.	KN260SP	KN260WP	KN260BP	KN160SP	KN160WP	KN160BP	KN760SP	KN760WP	KN760BP	KN260	KN360	KN860
Man.-Off-Auto.	KN262SP	KN262WP	KN262BP	KN162SP	KN162WP	KN162BP	KN762SP	KN762WP	KN762BP	KN262	KN362	KN862
Open-Off-Close	KN263SP	KN263WP	KN263BP	KN163SP	KN163WP	KN163BP	KN763SP	KN763WP	KN763BP	KN263	KN363	KN863
Up-Off-Down	KN264SP	KN264WP	KN264BP	KN164SP	KN164WP	KN164BP	KN764SP	KN764WP	KN764BP	KN264	KN364	KN864
Low-Off-High	KN265SP	KN265WP	KN265BP	KN165SP	KN165WP	KN165BP	KN765SP	KN765WP	KN765BP	KN265	KN365	KN865
Jog-Stop-Run	KN267SP	KN267WP	KN267BP	KN167SP	KN167WP	KN167BP	KN767SP	KN767WP	KN767BP	KN267	KN367	KN867
High-Low-Off	KN270SP	KN270WP	KN270BP	KN170SP	KN170WP	KN170BP	KN770SP	KN770WP	KN770BP	KN270	KN370	KN870
High-Off-Low	KN277SP	KN277WP	KN277BP	KN177SP	KN177WP	KN177BP	KN777SP	KN777WP	KN777BP	KN277	KN377	KN877
Auto-Man.-Off	KN278SP	KN278WP	KN278BP	KN178SP	KN178WP	KN178BP	KN778SP	KN778WP	KN778BP	KN278	KN378	KN878

(1) Legend plate has red background with silver letters.
 (2) Legend plate has red background with black letters.

Harmony™ 9001K/SK/KX

30 mm push buttons

9001K – Legend plates

Note: When ordering, add prefix “9001” to the reference.

Legend Plates—Special Marking			
Legend Plate	Description	Reference	
KN100●P (Plastic) (1) 2.25 in Square	Standard Markings	See page 25	
	Special Marking	Silver Field, Black Letters	KN199SP
		White Field, Black Letters	KN199WP
		Red Field, Black Letters	KN199RP
	Black Field, White Letters	KN199BP	
KN200 Aluminum	Standard Markings	See page 25	
	Special Marking	Black Field	KN299
		Red Field	KN299R
KN200●P (Plastic) (1) 1.7 in Square	Standard Markings	See page 25	
	Special Marking	Silver Field, Black Letters	KN299SP
		White Field, Black Letters	KN299WP
		Red Field, Black Letters	KN299RP
	Black Field, White Letters	KN299BP	
KN300 Aluminum	Standard Markings	See page 25	
	Special Marking	Black Field	KN399
		Red Field	KN399R
KN400 Aluminum	Blank	KN400	
	Any Marking (2)	KN499	
KN500 Aluminum	Standard Markings	Select from page 25	
	Special Marking	Black Field	KN599
		Green Red Field	KN519
KN600 Aluminum	Blank	Black Field	KN600
		Red Field	KN600R
	Any Marking	Black Field	KN699
		Red Field	KN699R
KN700●P (Plastic) (1) 2.5 in Square	Standard Markings	Select from page 25	
	Special Marking	Silver Field, Black Letters	KN799SP
		White Field, Black Letters	KN799WP
		Red Field, Black Letters	KN799RP
	Black Field, White Letters	KN799BP	
KN800 Aluminum	Standard Markings	Select from page 25	
	Special Marking	Blue Field	KN899
		Red Field	KN899R
KN900 Aluminum	Blank	KN900	
	Any Marking (2)	KN999	

(1) Other colors available (see table below).
(2) Specify marking required.

Plastic Legend Plates—Other Colors					
	Plate Color	Letter Color	1.7 in Square	2.25 in Square	2.5 in Square
Blank Legend Plates	Yellow	Black	KN200YP	KN100YP	KN700YP
	Green	White	KN200GP	KN100GP	KN700GP
	Blue		KN200LP	KN100LP	KN700LP
	Red		KN200CP	KN100CP	KN700CP
	Orange		KN200AP	KN100AP	KN700AP
Special Engraved Legend Plates	Burnt Orange	Black	KN200HP	KN100HP	KN700HP
	Yellow	Black	KN299YP	KN199YP	KN799YP
	Green	White	KN299GP	KN199GP	KN799GP
	Blue		KN299LP	KN199LP	KN799LP
	Red		KN299CP	KN199CP	KN799CP
	Orange		KN299AP	KN199AP	KN799AP
	Burnt Orange	Black	KN299HP	KN199HP	KN799HP

Maximum Number of Lines and Characters for 9001KN Legend Plates									
Reference	KN100	KN200	KN300	KN400	KN500	KN600	KN700	KN800	KN900
Max. No. of Char. per Line	16	14	18	18	8	22	17	18	18
					per field				per pos.
Max. No. of Lines	2	1	3	2	2	4	2	2	1
					per field				per pos.

Note: The maximum number of characters and lines is a practical maximum, based on a minimum size of characters to facilitate easy reading.

Circular Legends for Emergency Stop Mushroom Heads (yellow background)		
Diameter	Text	Reference
60 mm	—	KN9100
	EMERGENCY STOP	KN9330
90 mm	—	KN8100
	EMERGENCY STOP	KN8330



Legend Plate Position #1

Min. Centerline Spacing, 9001K Control Units							
Legend Plate	Operator	Centerline Spacing (in)					
		A	B	C	D	E	F
Legend Plate Orientation Position #1							
KN2	Standard Push Button	1.75	1.31	1.44	2.25	1.69	0.88
KN5	1.375 in Dia. Mushroom	1.75	1.31	1.44	2.25	1.69	0.88
	2.25 in Dia. Mushroom	2.25	1.31	1.44	2.25	2.25	1.12
	Selector Switch Knobs	1.75	1.31	1.44	2.25	1.69	0.88
KN3	Standard Push Button	2.00	1.31	1.44	2.25	1.75	0.88
	1.375 in Dia. Mushroom	2.00	1.31	1.44	2.25	1.75	0.88
	2.25 in Dia. Mushroom	2.25	1.31	1.44	2.25	2.25	1.12
	Selector Switch Knobs	2.00	1.31	1.44	2.25	1.75	0.88
KN4	Standard Push Button	1.94	1.31	1.44	2.25	1.62	0.88
	1.375 in Dia. Mushroom	1.94	1.31	1.44	2.25	1.62	0.88
	2.25 in Dia. Mushroom	2.25	1.31	1.44	2.25	2.25	1.12
	Selector Switch Knobs	1.74	1.31	1.44	2.25	1.62	0.88
KN6	Standard Push Button	2.38	1.62	1.44	2.25	2.25	1.12
	1.375 in Dia. Mushroom	2.38	1.62	1.44	2.25	2.25	1.12
	2.25 in Dia. Mushroom	2.38	1.62	1.44	2.25	2.25	1.12
	Selector Switch Knobs	2.38	1.62	1.44	2.25	2.25	1.12



Legend Plate Position #2

Legend Plate Orientation Position #2							
Legend Plate	Operator	A	B	C	D	E	F
KN2	Standard Push Button	1.62	1.31	1.44	2.25	1.75	0.88
KN5	1.375 in Dia. Mushroom	1.62	1.31	1.44	2.25	1.75	0.88
	2.25 in Dia. Mushroom	2.25	1.31	1.44	2.25	2.25	1.12
	Selector Switch Knobs	1.62	1.31	1.44	2.25	1.75	0.88
KN3	Standard Push Button	1.75	1.31	1.44	2.25	2.00	0.88
	1.375 in Dia. Mushroom	1.75	1.31	1.44	2.25	2.00	0.88
	2.25 in Dia. Mushroom	2.25	1.31	1.44	2.25	2.25	1.12
	Selector Switch Knobs	1.75	1.31	1.44	2.25	2.00	0.88
KN4	Standard Push Button	1.62	1.31	1.44	2.25	1.94	1.00
	1.375 in Dia. Mushroom	1.62	1.31	1.44	2.25	1.94	1.00
	2.25 in Dia. Mushroom	2.25	1.31	1.44	2.25	2.25	1.12
	Selector Switch Knobs	1.62	1.31	1.44	2.25	1.94	1.00
KN6	Standard Push Button	2.25	1.31	1.62	2.38	2.38	0.88
	1.375 in Dia. Mushroom	2.25	1.31	1.62	2.38	2.38	0.88
	2.25 in Dia. Mushroom	2.25	1.31	1.62	2.38	2.38	1.12
	Selector Switch Knobs	2.25	1.31	1.62	2.38	2.38	0.88

Special Legend Plates

9001KN500
(For Use with Dual Function Operators: KR6, KR7 and KR67)
Standard Markings

Reference	Green	Red
KN500	Blank	Blank
KN501	Start	Stop
KN502	On	Off
Reference	Black	Black
KN520	Blank	Blank
KN521	Start	Stop
KN522	On	Off
KN523	Forward	Reverse
KN524	Up	Down
KN525	High	Low
KN526	Open	Close

Harmony™ 9001K/SK/KX

30 mm push buttons

9001K – Accessories

Note: When ordering, add prefix “9001” to the reference.

Padlock Attachments			
Image	Used On	Description	Reference
	Non-illuminated push button — Standard or mushroom (KR4, KR5 mushroom buttons only).	Holds button in depressed position and can be padlocked.	K4
	Non-illuminated push buttons with or without protective boots.	Holds button in depressed position when padlocked.	K5
	Non-illuminated push buttons with or without protective boots.	Holds button in depressed position when padlocked.	K97
	Non-illuminated push buttons, cover type attachment. KR, SKR	Attachment can be padlocked. Does not hold button in depressed position.	K6
	Push buttons, cover type attachment.	Spring loaded cover cannot be padlocked. Does not hold button in depressed position.	K60
	Push-pull operator and illuminated push buttons. KR8, KR9	Holds button in depressed position and can be padlocked.	K62
	KR11U and KR12U Interlocked Assembly	Holds maintained button in depressed position and can be padlocked.	K96
	9001KR9 Push-pull operators— Non-Illuminated and Illuminated	Holds button in depressed position. Can be padlocked.	K162

Mushroom Button Guards



Reference	Reference	Used On	Reference	Used On
K48	K56▲ (1)	KR4	K68	KR5
	K56■M (2)	KR8, KR9	K685	KR25

(1) Replace ▲ with B=Black, G=Green, R=Red or Y=Yellow.
 (2) Replace ■ with R=Red or Y=Yellow. The mushroom guard has finger holes for push-pull operators.

Padlock Attachments			
Image	Used On	Description	Reference
	Selector switches and potentiometers (will not work with gloved-hand knob).	Cover type attachment that can be padlocked to keep unauthorized personnel from tampering with the operator.	K7
	Selector switches and potentiometers (will not work with gloved-hand knob).	Same as 9001K7 but with spring loaded lockout cover.	K107
	Illuminated push buttons (with or without guard) and key operated push buttons.	Cover type attachment that can be padlocked to keep unauthorized personnel from tampering with the operator.	K108
	Illuminated push buttons (with or without guard) and key operated push buttons.	Same as 9001K108 but with spring loaded lockout cover.	K109
	Maintained push-pull operators using 1.375 in dia. mushroom buttons (-20 series as shown on page 28).	Cover type attachment that holds mushroom button in depressed position and can be padlocked.	K110

Protective Boots



These 9001KU protective boots are recommended for very dirty environments or severe hose down, but they are not required for UL Type 4 rating on the 9001K operators. The 9001K1 wrench (see page 29) is required for installation of these boots.

For Non-Illuminated Push Buttons (3)		Clear Color for	Reference
Color	Reference	Standard knob selector switch	KU17
Black	KU1	Gloved-hand cap for use on standard knob selector switch	KU18
Red	KU2		
Blue	KU3		
Brown	KU4	Standard pilot light and maintained contact push buttons	KU27
Green	KU5		
Yellow	KU6		
Clear	KU7	Push-to-test and illuminated push button without guard	KU37
Clear	KU8	Illuminated push button with guard	KU47

(3) Use KU27 for maintained contact push buttons.

Closing Plates



Round (1-1/2 in Dia.)

Description	Reference
Gray	K51 (4)
Black	K52 (4)

(4) Meets UL and NEMA 1, 2, 3, 4, 4X, 6, 12 and 13.

Harmony™ 9001K/SK/KX

30 mm push buttons

9001K – Accessories

Note: When ordering, add prefix “9001” to the reference.

Accessories							
Description	Color	Reference	Package Qty.	Description	Color	Reference	Package Qty.
 <p>Color inserts for KR1, KR2, KR3, KR11, KR12, KRD, T, TRD</p>	Black	T8BK	10	 <p>1-3/8 in Mushroom Knob for Illuminated Push Buttons K2L (9)</p>	Amber	A20	1
	Blue	T8BE			Blue	L20	
	Gray	T8GY			Clear	C20	
	Green	T8GN			Green	G20	
	Orange	T8OE			Red	R20	
	Red	T8RD			White	W20	
	Universal (1)	T8U	7		Yellow	Y20	
	White	T8WH	10	 <p>2-1/4 in Mushroom Knob for Illuminated Push Buttons K2L (9)</p>	Amber	A21	1
	Yellow	T8YW			Blue	L21	
	Black	K16B	1		Clear	C21	
	Blue	K16L			Green	G21	
	Green	K16G		Red	R21		
	Orange	K16S		White	W21		
	Red	K16R		Yellow	Y21		
	Red (2)	K16R05		 <p>Plastic Fresnel Pilot Light Lens for KP, KT</p>	Amber	A31	1
	Yellow	K16Y			Blue	L31	
	Black	K17B	1		Clear	C31	
	Blue	K17L			Green	G31	
	Green	K17G		Red	R31		
	Orange	K17S		White	W31		
	Red	K17R		Yellow	Y31		
	Red (2)	K17R05		 <p>Domed Plastic Pilot Light Lens for KP, KT</p>	Amber	A9	1
	Yellow	K17Y			Blue	L9	
	Black	K92B	1		Clear	C9	
	Blue	K92L			Green	G9	
	Green	K92G		Red	R9		
	Orange	K92S		White	W9		
	Red	K92R		Yellow	Y9		
	Yellow	K92Y		 <p>Glass Pilot Light Lens for KP, KT</p>	Amber	A6	1
	Black	K93B	1		Blue	L6	
	Blue	K93L			Clear	C6	
	Green	K93G			Green	G6	
	Orange	K93S		Red	R6		
	Red	K93R		White	W6		
	Yellow	K93Y		Yellow	Y6		
	Amber	A22	1	 <p>Standard Selector Switch Knob for 9001K Selector Switches</p>	Amber	A8	1
	Black (7)	B23			Black (7)	B11	
	Blue	L22			Blue	L8	
	Clear	C22			Clear	C8	
	Green	G22		Green	G8		
	Orange (7)	S23		Orange (7)	S11		
	Red	R22		Red	R8		
	Red (10)	R2205		White	W8		
	White	W22		Yellow	Y8		
	Yellow	Y22		 <p>Gloved-Hand Selector Switch Knob for 9001K Selector Switches</p>	Amber	A24	1
	Black	B19	10		Black (7)	B25	
	Green	G19			Blue	L24	
	Red	R19			Clear	C24	
	Universal (8)	U19		Green	G24		
	Amber	A7	1	Orange (7)	S25		
	Blue	L7		Red	R24		
	Clear	C7		White	W24		
	Green	G7		Yellow	Y24		
	Red	R7		 <p>Color Inserts for KQ and TQ Selector Push Buttons</p>	Black	T5BK	10
	White	W7			Blue	T5BE	
	Yellow	Y7			Green	T5GN	
	Red	R94	1		Orange	T5OE	
	Red	K92RM	1	Red	T5RD		
	Green	K92GM		White	T5WH		
	Black	K92BM		Yellow	T5YW		
	Red	K93RM	1	 <p>Selector Switch Cams</p>	Description	Cam	Reference
	Green	K93GM			B		K13B
	Black	K93BM			C		K13C
	Red	K94RM	1		D		K13D
	Green	K94GM		E		K13E	
	Black	K94BM		F		K13F	
	Red	K95RM	1	G		K13G	
	Green	K95GM		H		K13H	
	Black	K95BM		J		K13J	
	Red	K95RM	1	L		K13L	
	Green	K95GM		M		K13M	
	Black	K95BM					

(1) Includes one each of the following color inserts: Black, Red, Green, Yellow, Orange, Blue, and White.
 (2) “EMERGENCY STOP” is in raised letters and hot stamped white across the front of the mushroom button.
 (3) The mushroom button cap listed here may be assembled to a 9001KR1U to form a 9001KR4.
 (4) The mushroom button cap listed here may be assembled to a 9001KR1U to form a 9001KR5.
 (5) The mushroom button cap listed here may be assembled to a 9001KR20 to form a 9001KR24.
 (6) The mushroom button cap listed here may be assembled to a 9001KR20 to form a 9001KR25.
 (7) These color caps are opaque and are for use on non-illuminated operators only.
 (8) Includes two of each of the following color inserts: Black, Red, and Green.
 (9) May be used on KR8 and KR9 operators. Order mushroom button and K54 adapter (no charge) from page 29. Using the K54 adapter voids Type 6 rating.
 (10) Red knob with “Push Emergency Stop” marked on top of knob.

Harmony™ 9001K/SK/KX

30 mm push buttons

9001K – Replacement parts

Ring Nuts	
Used On	Reference
K1L	9001K44
K30-K37	9001K45
K70-K73	9001K45
K20, K21, K22, K23	9001K45
K20, K21, K22, K23 (1)	9001K46
K2L	9001K49
K3L (complete)	9001K111
K3L (metal top only)	6515802701
KP, KTR	9001K41
KR1	9001K41
KR11	9001K42
KR12 (1)	9001K42
KR12 (2)	9001K41
KR13, 14, 15	9001K55
KR2	9001K42
KR20	9001K49
KR24	9001K49
KR25	9001K49
KR3	9001K40
KR4	9001K41
KR5	9001K41
KR6	9001K47
KR67	9001K47
KR7	9001K47
KR8	9001K58
KR9	9001K41
KS	9001K45
KS (3)	9001K46
KT	9001K49

(1) Maintained button of two button operator.

(2) Momentary button of two button operator.

(3) Secondary ring nut (holds knob on selector switch or potentiometer).

Replacement Lamps For Series A–F (black) Light Modules

Light Module Reference	Lamp Number (ANSI)	Schneider Electric Replacement Lamp Reference
KM1	GE44 (4)	—
KM2	GE1490	2550101003
KM3	GE44 (4)	—
KM4	GE1490	2550101003
KM5	GE44 (4)	—
KM6	GE44 (4)	—
KM7	GE44 (4)	—
KM8	GE44 (4)	—
KM9	GE755	2550101020
KM11	CMDK1A5	2550105014
KM12	CMDK1A5	2550105014
KM13	CMDK1A5	2550105014
KM14	CMDK1A5	2550105014
KM15	CMDK1A5	2550105014
KM21	SYL12PSB	2550105003
KM22	SYL12PSB	2550105003
KM23	SYL28PSB	2550105008
KM25	SYL120PSB	2550105005
KM31	SYL6PSB	2550105007
KM32	SYL12PSB	2550105003
KM34	SYL24PSB	2550105004
KM35	SYL28PSB	2550105008
KM36	SYL48PSB	2550105009
KM37	SYL60PSB	2550105010
KM38	SYL120PSB	2550105005

(4) GE44 and GE755 are interchangeable (GE755 gives longer life). If a GE44 lamp is ordered, a GE755 (2550101020) will be substituted. For a replacement lamp in a current series light module see the light module listing on page 24.

Product range:
page 5Specifications:
page 7Dimensions:
page 30Mounting:
page 31

Repair Parts	
Description	Reference
E10 Key	2941101100
Gray cap for KR11 or KR12	3105217001
Clear plastic top (only) for 9001K44 Ring Nut	4487D63XI
Gasket for 9001K Push-pull Knob	6509701801
Gasket for Plastic Illuminated Lens	6509701901
Gasket for 9001K selector switch knob	3105406401
Black Compensating Gasket (9001K Operators)	6509702001
Liner for Non-Illuminated Operators	6509704901
Locking Thrust Washer	6512231201
Nylon Spacer	6509705001
Push-pull Mushroom Adapter (5)	9001K54
Rubber Boot for Joystick	6512243201
Knob on Joysticks without latch	4458D20X3
Knob for SK Potentiometer	3105404408
Fingersafe Cover for 9001KM	6508804101

(5) Allows Type -20 and -21 mushroom color caps to be used on push-pull operators. Use of 9001K54 voids Type 6 rating.

KU Replacement Ring Nuts (Threaded Inside and Out)

Used On	Reference
KU1 through KU8, KU27, KU37, KU47	3105204101
KU17, KU18	3105205901

Interlock



For mechanically interlocking two push buttons so that only one button can be depressed at a time. A K3 attachment is furnished with the 9001KR11 and KR12 operators. However, these are maintained operators and the K3 interlock serves to release one of the buttons when the other is depressed. When used with momentary contact buttons, the K3 interlock does not hold the buttons in the depressed position. It simply prevents pushing both buttons at the same time.

The K3 interlock is mounted behind the operators. Operators not included.

Reference

9001K3

Screwdriver

Reference



9001K69

Used to tighten mounting screws on contact blocks and light modules.

Wrenches

K95



K1



Where Used

Reference

For tightening ring nuts on 22 and 30 mm control units

9001K95

For protective cap kits

9001K1

Harmony™ 9001K/SK/KX

30 mm push buttons

9001K

Dimensions

Push buttons



e: panel thickness 1 to 6 mm

Full guard
9001KR1●●●



No guard
9001KR3●●●



No guard with extended guard
9001KR2●●●



Mushroom head push buttons

Spring return 35 mm:
9001KR24●H13,
9001KR4RH6,
9001KR9R20H6

Spring return 57 mm:
9001KR25●H13,
9001KR5RH6
Spring return 60 mm:
9001KR25●M

Push-pull 35 mm:
9001KR9R20H6
Push-pull 40 mm:
9001KR24●M
9001KR9●M94
Push-pull 41 mm:
9001KR9●H13,
9001KR9R94H13
9001KR9RH6
9001KR8●H25
Push-pull 57 mm:
9001KR9R21H6
Push-pull 60 mm:
9001KR9●M95

Spring return 35, 57 and 60 mm a = 28 mm

Push-pull 35 to 60 mm a = 32 mm



e: panel thickness 1 to 6 mm



Turn-to-release 9001KR16H13, 9001KR16H2 and 9001KR16



e: panel thickness 1 to 6 mm



Selector switches

Gloved handle 9001KS●●FBH●●



e: panel thickness 1 to 6 mm



Dual Dimensions: in (mm)

Dimensions (continued)

Selector switches (continued)



e: panel thickness 1 to 6 mm

Key switches 9001KS●●K●●● (for the chromium metal bezel range only)

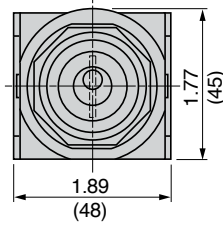

Mounting

Contact block mounting position



1 For Maximum Contact Block Usage, see page 22.

Panel cut-out



Individual cut-outs detail

2 alternatives



Preferred Cut-Out

Alternate Cut-Out

Use Greenlee Tool #60242 for punching hole and notch.

Type of 9001K unit	Legend plate	a: in (mm)	b: in (mm)
All units except 57 mm mushroom head push buttons	9001KN2●●	2.25 (57.2)	1.75 (44.5)
	9001KN3●●	2.25 (57.2)	2.00 (50.8)
57 mm mushroom head push buttons	9001KN2●●	2.25 (57.2)	2.25 (57.2)
	9001KN3●●	2.25 (57.2)	2.25 (57.2)

Dual Dimensions: in (mm)

Dimensions (continued)

Pilot lights

With BA 9s bulb 9001KP●●●



e: panel thickness 1 to 6 mm

Illuminated mushroom head push buttons

9001KR●P●●●



e: panel thickness 1 to 6 mm

Illuminated push buttons, spring return

Full guard 9001K3L●●●●H13



e: panel thickness 1 to 6 mm

Joystick controllers (for the chromium metal bezel range only)

9001K●●H●



e: panel thickness 1 to 6 mm

No guard 9001K2L●●●●H13



e: panel thickness 1 to 6 mm

Heads for spring return push buttons

9001KR●U



Push-to-test, no guard 9001KT●●●●31



e: panel thickness 1 to 6 mm

Boots for push buttons

9001KU●



Dual Dimensions: in (mm)

Dimensions (continued)

Rod for wobble stick

9001K8



Interlocked push buttons

9001KR11, 9001KR12, and 9001K3 interlock



Light blocks for pilot lights and illuminated push buttons

9001KM●



e: panel thickness 1 to 6 mm

Contact blocks for push buttons (including illuminated)

9001KA●



e: panel thickness 1 to 6 mm

It is not possible to mount complementary contact blocks 9001KA4 to KA6.

Legend plates

Aluminium plates 9001KN1●●, 9001KN2●●, 9001KN7●●



Legend plate	a: in (mm)	b: in (mm)
9001KN2●●	1.625 (41)	0.969 (24)
9001KN3●●	1.750 (45)	1.234 (31)

Plastic plates 9001KN1●●P, 9001KN2●●P, 9001KN7●●P



Legend plate	a: in (mm)	b: in (mm)
9001KN1●●P	2.25 (57)	2.25 (57)
9001KN2●●P	1.75 (45)	1.75 (45)
9001KN7●●P	2.50 (63)	2.50 (63)

Potentiometer

9001K20 (1), 9001K21 (2)



(1) Without potentiometer
(2) With potentiometer

9001K22 (1), 9001K23 (2)



(1) Without potentiometer
(2) With potentiometer

Dual Dimensions: in (mm)

Harmony™ 9001K/SK/KX

30 mm push buttons

9001K

Dimensions (continued)

Time delay push button

9001KRD



	a	b
9001KRD1UH●	Full guard 9/16	2-1/2
9001KRD2UH●	Extended guard 11/16	2-1/2
9001KRD3UH●	No guard 9/16	2-1/2

Alternate action—Push-on, push-off module

9001K85



Emergency break glass operator

9001K15



Rocker arm operating lever

9001K50



Dual Dimensions: in (mm)

Harmony™ 9001K/SK/KX

30 mm push buttons

9001K

Dimensions (continued)

Padlock attachments

9001K4



9001K96



9001K7, 9001K107, 9001K108, 9001K109, 9001K113



9001K6, 9001K60, 9001K97



9001K62



9001K5



Mushroom button guards

9001K48



9001K56Y, 9001K56YM (1)



9001K68



(1) 9001K56YM includes finger holes.

Dual Dimensions: in (mm)

Complete units

Contact functions

Push buttons, spring return



Full guard

9001SKR1●●● See page 41



No guard

9001SKR3●●● See page 41



Extended guard

9001SKR2●●● See page 41

Mushroom head push buttons



Spring return 1-3/8 or 2-1/4 in (35 or 57 mm)

9001SKR2●●H13 See page 41



Push-pull 1-3/8, 1-5/8 or 2-1/4 in (35, 41 or 57 mm)

9001SKR●●● See page 41



Turn-to-release, trigger action

9001SKR16 (1) See page 43

Selector switches



Selector switches

9001SKS●●FBH●● See page 44

Light functions

Pilot lights



BA 9s base mounted super bright LED

9001SKP●●● See page 48



BA 9s incandescent bulb

9001SKP●●● See page 48

(1) Complies with EN418/ISO13850 standards for Emergency Stop push buttons when used with circular Legend Plate 9001KN8330 (90 mm diameter) or 9001KN9330 (60 mm diameter). See page 56.

Harmony™ 9001K/SK/KX 30 mm push buttons

9001SK – Complete units, components and accessories

Complete units

Combined contact and light functions

Illuminated push buttons, spring return



Full guard

9001SK1L●●● See page 42



No guard

9001SK2L●●● See page 42



Push-to-test, no guard

9001SKT●●●31 See page 48

1-5/8 in (41 mm) mushroom head illuminated push buttons



2-Position, push-pull

9001SKR9P●●● See page 43



3-Position, push-pull

9001SKR8P●●● See page 43

Separate components and accessories



Complete units are composed of:

- 1 - Contact block
- 2 - Light module with lamp
- 3 - Black compensation gaskets
- 4 - Legend plate
- 5 - Locking thrust washer
- 6 - Ring nut
- 7 - Color cap
- 8 - Color insert

Specifications:
page 38

References:
page 41

Dimensions:
page 60

Mounting:
page 61

Harmony™ 9001K/SK/KX

30 mm push buttons

9001SK

Environmental specifications			
Conforming to standards	 		EN/IEC 60947-1, EN/IEC 60947-5-1, EN/IEC 60947-5-4, JIS C 4520 and 852, UL 508, CSA C22-2 n° 14, CE marked, RoHS compliant
Product certifications	 File E78403 CCN NKCR  File LR25490 Class 3211-03		UL File E78403, CCN NKCR and CSA File LR25490, Class 3211-03
Protective treatment standard version			"TC"
Ambient air temperature around the device	Storage	°F (°C)	-40 to +158 (-40 to +70)
	Operation	°F (°C)	-13 to +158 (-25 to +70)
Vibration resistance	Conforming to IEC 60068-2-6		Frequency: 2 to 500 Hz: 7gn Ford Standard EA-1
Shock resistance	Conforming to IEC 60068-2-27		Half sine wave: 50 gn
Electric shock protection	Conforming to IEC 61140		Class II
Degree of protection	Conforming to EN/IEC 60529		IP 66
	Conforming to NEMA		Types 1, 2, 3, 3R, 4, 12 and 13
Mechanical life (in millions of operating cycles)	Push buttons, spring return		5
	Illuminated push buttons		5
	Selector switches and key switches		0.5
Mounting position			All positions

Electrical characteristics of contact blocks			
Rated operational characteristics	~ AC-15		3 A, 240 V
	--- DC-13		0.55 A, 125 V
Rated insulation voltage	Conforming to EN/IEC 60947-1	V	U _i = 250 degree of pollution 3 (except pilot lights with incandescent bulb: degree of pollution 2)
Rated impulse withstand voltage	Conforming to EN/IEC 60947-1	kV	U _{imp} = 2.5
Contact material	Normal environment and usage		Silver alloy
Contact operation	"N/C" ou "N/O"		Slow break
Positive operation	Conforming to EN/IEC 60947-5-1	N	N/C contact(s) with positive opening operation
Short-circuit protection	Conforming to EN/IEC 60947-5-1	A	Cartridge fuse mounted upstream: 10
Cabling capacity (9001KA contact blocks and 9001KM light modules)	Conforming to EN/IEC 60947-1	mm² mm²	Screw clamp terminals (cross headed/slotted screw) Mini: 1 x 0.22 Maxi: 2 x 1.5 Recommended tightening torque: 0.8 N.m (10 in-lbs)
Thermal current	I _{th}	A	10
Maximum operation current	a.c. supply: utilization category AC-15 NEMA A600	V	Contact making capacity
		A	120 240 480 600
		VA	60 30 15 12
	d.c. supply: utilization category DC-13 NEMA Q600	VA	7200 7200 7200 7200
		V	Breaking capacity
		A	120 240 480 600
VA	6 3 1.5 1.2		
VA	720 720 720 720		
		V	Contact making capacity and breaking capacity
		A	125 250 600 0.1
		A	0.55 0.27 0.1

Basic Operators

(For Color Caps, Mushroom Buttons, Knobs, Selector Switch Cams, Contact Blocks, Light Modules and Legend Plates, see page 51.)

Description	UL Types/NEMA Types
	4, 4X, 13
Non Illuminated Push Button (Full Guard)	9001SKR1
Non Illuminated Push Button (Extended Guard)	9001SKR2
Non Illuminated Push Button (No Guard)	9001SKR3
Non Illuminated Push Button (Mushroom Button/screw on)	9001SKR20
Non Illuminated Dual Push Button (Momentary)	–
Non Illuminated Dual Push Button (Momentary Interlocked)	–
Non Illuminated Dual Push Button (Maintained Interlocked)	–
Momentary Pull - Maintained Neutral - Momentary Push	9001SKR8 (1)
Maintained Pull - Maintained Push	9001SKR9 (1)
Illuminated Push Button (Full Guard - Plastic Top)	9001SK1L (2)
Illuminated Push Button and Push-to-test (No Guard)	9001SK2L (2) (3)
Illuminated Push Button (Full Guard - Metal Top)	–
Standard Pilot Light	9001SKP
2-Position Selector Switch	9001SKS1 (1), 9001SKS2 (1), 9001SKS3 (1)
3-Position Selector Switch	9001SKS4 (1), 9001SKS5 (1), 9001SKS6 (1), 9001SKS7 (1)
4-Position Selector Switch	9001SKS8 (1)
Trigger-Action Emergency Stop	9001SKR16 (1)

(1) Operator can be converted to an illuminated operator by removing the liner (6509704901) and adding a light module.

(2) Operator can be converted to a non-illuminated operator by adding liner (6509704901).

(3) Operator includes jumper wires for push-to-test conversion.

Non Hazardous Locations:



Hazardous Locations (Reed contact blocks, see page 53):



Harmony™ 9001K/SK/KX

30 mm push buttons

9001SK

9001SK Operator Materials:

Push Button and Push-to-test Pilot Light
(9001SKR and 9001SKT)

- Base – Thermoplastic Polyester
- Stem – Acetal (non-illuminated push button)
Thermoplastic Polyester (illuminated push button
and push-to-test pilot light)
- Seal – Nitrile
- Gasket – Nitrile
- Spring – 302 Stainless Steel
- Spring Support – CRS
- Lock Ring – Nylon
- Trim Washer – Polypropylene
- Locking Thrust Washer – Thermoplastic Polyester
- Ring Nut – Thermoplastic Polyester
- Color Insert – Polyethylene (non-illuminated push button)
- Color Cap – Polycarbonate (illuminated push button and
push-to-test pilot light)
- Mushroom Button – Acetal (non-illuminated push button)
Polycarbonate (illuminated push button)
- Liner – Polypropylene (non-illuminated push button)

Selector Switch (9001SKS)

- Base – Thermoplastic Polyester
- Seal – Nitrile
- Gasket – Nitrile
- Seal Keeper – 302 Stainless Steel
- Spring – 302 Stainless Steel
- Cam Follower – Delrin 100
- Bearing Washer – Polyester Film
- Cam Carrier – Trogamid
- Cam Profile – Delrin 100
- Liner – Polypropylene (non-illuminated only)
- Knob – Polycarbonate
- Trim Washer – Polypropylene
- Locking Thrust Washer – Thermoplastic Polyester
- Spring Support – CRS

Pilot Light (9001SKP)

- Gasket – Nitrile
- Base – Thermoplastic Polyester
- Trim Washer – Polypropylene
- Locking Thrust Washer – Thermoplastic Polyester
- Ring Nut – Thermoplastic Polyester
- Color Cap – Polycarbonate

Contact Block And Light Module Materials:

Contact Block (9001KA)

- Housing – Amorphous Nylon
- Contact Slider – Phenolic, Nylon or Acetal
- Terminal – Steel
- Saddle Clamp – Steel
- Spring – Stainless Steel
- Contacts – Silver and Copper
- Blade – Beryllium Copper
- Mounting Screw – Steel
- Label – Paper

Light Module (9001KM)

- Housing – Thermoplastic Polyester
- Socket – Steel
- Terminal – Steel with Tin Plate
- Saddle Clamp – Steel
- Translating Pin – Polycarbonate
- Transformer – Thermoplastic Polyester, Steel, Copper,
Polyvinyl Chloride, Polytetrafluorethylene,
Acetate, Paper
- Lamp Spring – Tin Plated Music Wire

Harmony™ 9001K/SK/KX 30 mm push buttons

9001SK – Push buttons and mushroom operators

Note: When ordering, add prefix “9001” to the reference.

**Non-Illuminated Momentary Push Button Operators—UL Types 4, 4X, 13/NEMA 4, 4X, 13
For use in hazardous locations, see page 53.
Contact blocks and legend plate not included unless otherwise noted.**

Description	Color	Operator with 1 N.O. and 1 N.C. Contact (KA1)	Operator with 1 N.O. Contact (KA2)	Operator with 1 N.C. Contact (KA3)	Operator Only No Contacts (5)
 <p>9001SKR1B Full Guard</p>	Black	SKR1BH13	SKR1BH5	SKR1BH6	SKR1B
	Red	SKR1RH13	SKR1RH5	SKR1RH6	SKR1R
	Green	SKR1GH13	SKR1GH5	SKR1GH6	SKR1G
	Universal (1)	SKR1UH13	SKR1UH5	SKR1UH6	SKR1U
	Other (2)	SKR1■H13	SKR1■H5	SKR1■H6	SKR1■
 <p>9001SKR3B No Guard</p>	Black	SKR3BH13	SKR3BH5	SKR3BH6	SKR3B
	Red	SKR3RH13	SKR3RH5	SKR3RH6	SKR3R
	Green	SKR3GH13	SKR3GH5	SKR3GH6	SKR3G
	Universal (1)	SKR3UH13	SKR3UH5	SKR3UH6	SKR3U
	Other (2)	SKR3■H13	SKR3■H5	SKR3■H6	SKR3■
 <p>9001SKR2B Extended Guard</p>	Black	SKR2BH13	SKR2BH5	SKR2BH6	SKR2B
	Red	SKR2RH13	SKR2RH5	SKR2RH6	SKR2R
	Green	SKR2GH13	SKR2GH5	SKR2GH6	SKR2G
	Universal (1)	SKR2UH13	SKR2UH5	SKR2UH6	SKR2U
	Other (2)	SKR2■	SKR2■H5	SKR2■H6	SKR2■
Snap-In Mushroom Button					
 <p>9001SKR4B 1-3/8 in (35 mm) Mushroom Button</p>	Black	SKR4BH13	SKR4BH5	SKR4BH6	SKR4B
	Red	SKR4RH13	SKR4RH5	SKR4RH6	SKR4R
	Red (3)	SKR4R05H13	SKR4R05H5	SKR4R05H6	SKR4R05
	Green	SKR4GH13	SKR4GH5	SKR4GH6	SKR4G
	Other (4)	SKR4★H13	SKR4★H5	SKR4★H6	SKR4★
Screw-On Mushroom Button with Set Screw Security					
 <p>9001SKR5 2-1/4 in (57 mm) Mushroom Button</p>	Black	SKR24BH13	SKR24BH5	SKR24BH6	SKR24B
	Red	SKR24RH13	SKR24RH5	SKR24RH6	SKR24R
	Green	SKR24GH13	SKR24GH5	SKR24GH6	SKR24G
	Other (4)	SKR24★H13	SKR24★H5	SKR24★H6	SKR24★
	Snap-In Mushroom Button				
 <p>9001SKR5 2-1/4 in (57 mm) Mushroom Button</p>	Black	SKR5BH13	SKR5BH5	SKR5BH6	SKR5B
	Red	SKR5RH13	SKR5RH5	SKR5RH6	SKR5R
	Red (3)	SKR5R05H13	SKR5R05H5	SKR5R05H6	SKR5R05
	Green	SKR5GH13	SKR5GH5	SKR5GH6	SKR5G
	Other (4)	SKR5★H13	SKR5★H5	SKR5★H6	SKR5★
Screw-On Mushroom Button with Set Screw Security					
 <p>9001SKR5 2-1/4 in (57 mm) Mushroom Button</p>	Black	SKR25BH13	SKR25BH5	SKR25BH6	SKR25B
	Red	SKR25RH13	SKR25RH5	SKR25RH6	SKR25R
	Green	SKR25GH13	SKR25GH5	SKR25GH6	SKR25G
	Other (4)	SKR25★H13	SKR25★H5	SKR25★H6	SKR25★

Color Codes

Color	■ SKR1, 2, 3 Place Color Code in Reference	★ SKR4, 5, 24, 25 Place Color Code in Reference
Blue	L	L
Yellow	Y	Y
White	W	—
Orange	S	S
Gray	E	—

(1) The universal push button operators contain one each of the following color inserts: black, red, green, yellow, orange, blue and white.
 (2) Replace ■ with the color code as chosen from the color code table above.
 (3) Knob has the words “Emergency Stop” in raised letters highlighted in white for readability.
 (4) Replace ★ with the color code as chosen from the color code table above
 (5) These operators can be ordered complete with contact blocks. For maximum block usage, see page 51. Add the “H” number chosen from page 51 to the end of the operator reference number and add the cost of the “H” number to the operator cost.

To select and order Contact Blocks, Light Modules, Knobs, and Accessories, see pages 50 to 59.

Harmony™ 9001K/SK/KX 30 mm push buttons

9001SK – Push buttons and mushroom operators

Note: When ordering, add prefix “9001” to the reference.

Illuminated Push Button Operators—UL Types 4, 4X, 13/NEMA 4, 4X, 13
For use in hazardous locations, see page 53.
Legend plate not included unless otherwise noted.

Description	Voltage and Frequency	Style	With Red Color Cap and 1 N.O. and 1 N.C. Contact (KA1)	With Green Color Cap and 1 N.O. and 1 N.C. Contact (KA1)	With Other Color Cap Without Contact Blocks (1) (5)
 9001SK1L1 Full Guard Illuminated Push Button	110–120 V, 50–60 Hz	Transformer	SK1L1RH13	SK1L1GH13	SK1L1
	220–240 V, 50–60 Hz	Transformer	SK1L7RH13	SK1L7GH13	SK1L7
	24–28 Vac/Vdc	Full Voltage	SK1L35RH13	SK1L35GH13	SK1L35
	For other voltages (2)	Transformer, Flashing	SK1L■RH13	SK1L■GH13	SK1L▼
		Full Voltage	SK1L■RH13	SK1L■GH13	SK1L▼
		Resistor, Neon (3)	SK1L■RH13	SK1L■GH13	SK1L▼
LED	SK1L■RH13	SK1L■GH13	SK1L▼ (4)		
 9001SK2L1 No Guard Illuminated Push Button	110–120 V, 50–60 Hz	Transformer	SK2L1RH13	SK2L1GH13	SK2L1
	220–240 V, 50–60 Hz	Transformer	SK2L7RH13	SK2L7GH13	SK2L7
	24–28 Vac/Vdc	Full Voltage	SK2L35RH13	SK2L35GH13	SK2L35
	For other voltages (2)	Transformer, Flashing	SK2L■RH13	SK2L■GH13	SK2L▼
		Full Voltage	SK2L■RH13	SK2L■GH13	SK2L▼
		Resistor, Neon (3)	SK2L■RH13	SK2L■GH13	SK2L▼
LED	SK2L■RH13	SK2L■GH13	SK2L▼ (4)		
 9001SK2L1R20 1-3/8 in (35 mm) Illuminated Mushroom	110–120 V, 50–60 Hz	Transformer	SK2L1R20H13	SK2L1G20H13	Order SK2L▼ (4) (6)
	220–240 V, 50–60 Hz	Transformer	SK2L7R20H13	SK2L7G20H13	
	24–28 Vac/Vdc	Full Voltage	SK2L35R20H13	SK2L35G20H13	
	For other voltages (2)	Transformer, Flashing	SK2L■R20H13	SK2L■G20H13	
		Full Voltage	SK2L■R20H13	SK2L■G20H13	
		Resistor, Neon (3)	SK2L■R20H13	SK2L■G20H13	
LED	SK2L■R20H13	SK2L■G20H13			
 9001SK2L1R21 2-1/4 in (57 mm) Illuminated Mushroom	110–120 V, 50–60 Hz	Transformer	SK2L1R21H13	SK2L1G21H13	Order SK2L▼ (4) (6)
	220–240 V, 50–60 Hz	Transformer	SK2L7R21H13	SK2L7G21H13	
	24–28 Vac/Vdc	Full Voltage	SK2L35R21H13	SK2L35G21H13	
	For other voltages (2)	Transformer, Flashing	SK2L■R21H13	SK2L■G21H13	
		Full Voltage	SK2L■R21H13	SK2L■G21H13	
		Resistor, Neon (3)	SK2L■R21H13	SK2L■G21H13	
LED	SK2L■R21H13	SK2L■G21H13			

(1) These operators can be ordered complete with contact blocks. For maximum block usage, see page 51. Add the “H” number chosen from page 51 to the end of the operator reference number and add the cost of the “H” number to the operator cost.

(2) Replace ■ with the voltage assembly code as chosen from the tables on page 54. EXAMPLE: SK2L■ with 240 Vac/Vdc = SK2L25.

(3) On neon light modules, use clear color caps only.

(4) The cap must be the same color as the LED light module chosen e.g., for red LED, use red color cap.

(5) Replace ▼ with the color code as chosen from the color code table below. EXAMPLE: SK2L35▼ with a blue 1-3/8 in mushroom button = SK2L35L20.

(6) The only difference between a no guard (SK2L) operator and mushroom button operator is the color cap.

Color Caps

Color	Color Codes		
	SK1L/SK2L	1-3/8 in (35 mm) Mushroom	2-1/4 in (57 mm) Mushroom
Red	R	R20	R21
Green	G	G20	G21
Blue	L	L20	L21
Yellow	Y	Y20	Y21
White	W	W20	W21
Clear	C	C20	C21
Amber	A	A20	A21

To select and order Contact Blocks, Light Modules, Knobs, and Accessories, see pages 50 to 59.

Harmony™ 9001K/SK/KX

30 mm push buttons

9001SK – Multi-function operators

Note: When ordering, add prefix “9001” to the reference.

30 mm Multi-function Operators — UL Types 4, 4X, 13/NEMA 4, 4X, 13

Non-Illuminated Push-pull Screw-on Mushroom Operators

Description	Color	With 2 N.C. Contacts (1 KA3, 1 KA5)	With 1 N.O. / 1 N.C. Contact (1 KA1)	Without Contacts (6)	
3-Position					
 <p>9001SKR9R Non-Illuminated 1-5/8 in Diameter Knob Includes 9001KN179WP Legend Plate Marked Pull To Start / Push To Stop</p>	Momentary Pull-Maintained Neutral-Momentary Push (2) (7)	Red	SKR8RH25	—	SKR8R
		Green	SKR8GH25	—	SKR8G
		Other	SKR8■H25	—	SKR8■
2-Position (1)					
	Maintained Pull-Maintained Push (2)	Red	—	SKR9RH13	SKR9R
		Green	—	SKR9GH13	SKR9G
		Other	—	SKR9■H13	SKR9■

Positions for 9001SKR8RH1 or H13

	PULL	CTR	PUSH
(KA1)			
KA3	x	O	O
KA2	O	O	x

O = contact open; x = contact closed

Positions for 9001SKR8H25

	PULL	CTR	PUSH
KA3	x	O	O
KA5	x	x	O
KA2	O	O	x

Non-Illuminated Turn-to-release Mushroom Operators

Description	Color	With 1 N.O. Contact (KA1)	With 2 N.O. / 2 N.C. Contacts (2 KA1)	Without Contacts
 <p>9001SKR16H2</p> <p>2-Position Trigger-Action, Turn-to-Release 1-5/8 in. (40 mm) Non-Removal Plastic Mushroom</p> <p>Complies with EN418/ISO13850 standards for Emergency Stop push buttons when used with circular Legend Plate 9001KN8330 (90 mm diameter) or 9001KN9330 (60 mm diameter). See page 56.</p>	Red	SKR16H13	SKR16H2	SKR16

Illuminated Push-pull Mushroom Operators

Description	Voltage	With Red Knob and 2 N.C. Contacts (1 KA3, 1 KA5)	With Other Color Knob and 2 N.C. Contacts	With Other Color Knob Without Contacts (6)	
3-Position					
 <p>9001SKR9P1 1-5/8 in Diameter Knob with "Pull To Start / Push To Stop" 9001KN379 Legend Plate For 1-3/8 in or 2-1/4 in Diameter Knob (1)</p>	Momentary Pull-Maintained Neutral-Momentary Push (2) (3) (7)	110–120 V, 50–60 Hz	SKR8P1RH25	SKR8P1■H25	SKR8P1■
		Other—Transformer, LED, Flashing (4)	SKR8P♦RH25	SKR8P♦■H25	SKR8P♦■
		Other—Full Voltage, Resistor, Neon (5)	SKR8P♦RH25	SKR8P♦■H25	SKR8P♦■
2-Position					
	Maintained Pull-Maintained Push (2) (3) (7)	110–120 V, 50–60 Hz	SKR9P1RH13	SKR9P1■H13	SKR9P1■
		Other—Transformer, L.E.D., Flashing (4)	SKR9P♦RH13	SKR9P♦■H13	SKR9P♦■
		Other—Full Voltage, Resistor, Neon (5)	SKR9P♦RH13	SKR9P♦■H13	SKR9P♦■

- To obtain a red knob with "Push Emergency Stop" printed on the red knob—substitute R05 in place of "R".
- Replace ■ with the color code as chosen from the color code at right. Example: SKR9■ with a yellow knob = SKR9Y
- Replace ♦ with the voltage assembly code as chosen from the tables on page 54. Example: SKR8P♦ with 277 V 50–60 Hz = SKR8P8
- The knob must be the same color as the LED light module chosen; e.g., for green LED, use green knob.
- On neon light modules, use clear knobs only.
- These operators can be ordered complete with contact blocks. For maximum block usage, see page 51. Add the "H" number chosen from page 51 to the end of the operator reference number and add the cost of the "H" number to the operator cost.
- For positions, refer to the two tables below.

Color Codes

Color	SKR11, SKR12	SKR8, SKR9
Black (8)	B	B
Red	R	R
Green	G	G
Blue	L	L
Yellow	Y	Y
White	W	W
Orange (8)	S	S
Clear	—	C
Amber	—	A
Gray	E	—

(8) These colors are not available on illuminated push-pull operators.

To select and order Contact Blocks, Light Modules, Knobs, and Accessories, see pages 50 to 59.

Harmony™ 9001K/SK/KX

30 mm push buttons

9001SK – Selector switches

Note: When ordering, add prefix “9001” to the reference.

2-Position Selector Switches					1—Contact Closed		0—Contact Open	
Contact Block Required	Quantity and Type KA1 or KA2 or KA3		Mount on Side KA1 or KA2 or KA3		Left	Right	Left	Right
<p>Top View</p>	KA1	or	KA3	KA1 #2	1	0	0	1
			KA2	KA2 #2	0	1	1	0
	KA1	or	KA3	KA1 #1	1	0	0	1
			KA2	KA2 #1	0	1	1	0
Cam (see page 47)					E	D		

Non-Illuminated Operators		
Manual Return (1), Operator Only (without contact blocks)	Reference	Reference
Without Knob	SKS11	SKS12
With Knob (3)	SKS11♦	SKS12♦
Operator with Contact Blocks and Standard black knob	Reference	Reference
With 1 KA1 on Side #2	SKS11BH13	—
With 1 KA1 on Side #1	SKS11BH1	—
With 1 KA1 on Side #1 and 1 KA1 on side #2	SKS11BH2	—
Spring Return from Left (1), Operator Only (without contact blocks)	Reference	Reference
Without Knob	SKS25	—
With Knob (3)	SKS25♦	—
Spring Return from Right (1), Operator Only (without contact blocks)	Reference	Reference
Without Knob	—	SKS34
With Knob (3)	—	SKS34♦

Illuminated Operators		
Manual Return (1), Operator Only (without contact blocks)	Reference	Reference
Without Knob, 110-120V 50-60 Hz Transformer	SK11J1	SK12J1
With Standard Red Knob, 110-120V 50-60 Hz Transformer	SK11J1R	SK12J1R
With Other Color Knob and other voltage Light Module (2) (3)	SK11J■♦	SK12J■♦
Spring Return from Left (1), Operator Only (without contact blocks)	Reference	Reference
Without Knob, 110-120V 50-60 Hz Transformer	SK25J1	—
With Standard Red Knob, 110-120V 50-60 Hz Transformer	SK25J1R	—
With Other Color Knob and other voltage Light Module (2) (3)	SK25J■♦	—
Spring Return from Right (1), Operator Only (without contact blocks)	Reference	Reference
Without Knob, 110-120V 50-60 Hz Transformer	—	SK34J1
With Standard Red Knob, 110-120V 50-60 Hz Transformer	—	SK34J1R
With Other Color Knob and other voltage Light Module (2) (3)	—	SK34J■♦

(1) These operators can be ordered complete with contact blocks. Add the “H code” from page 51 as needed for your application.
 (2) Replace ■ with the voltage assembly code as chosen from the tables on page 54. Example: K25J■ with 208Vac = K25J3
 (3) Replace ♦ with the color code as chosen from the color code table below. For LED, knob color must match LED.

Selector Switch Assembly Code and Knob Cat. No.				
Color	Standard Knob		Gloved Hand Knob	
	♦ Knob Code	Reference	♦ Knob Code	Reference
Black	B	B11	FB	B25
Red	R	R8	FR	R24
Green	G	G8	FG	G24
Yellow	Y	Y8	FY	Y24
Blue	L	L8	FL	L24
White	W	W8	FW	W24
Amber	A	A8	FA	A24
Clear	C	C8	FC	C24

To select and order Contact Blocks, Light Modules, Knobs, and Accessories, see pages 50 to 59.



Harmony™ 9001K/SK/KX

30 mm push buttons

9001SK – Selector switches

Note: When ordering, add prefix “9001” to the reference.

3-Position Selector Switches

Contact Block Required Contact Block Position	Quantity and Type	Mount on Side	1 — Contact Closed		0 — Contact Open		Center		Center		Center		Center	
			Center	Center	Center	Center	Center	Center	Center	Center	Center	Center	Center	Center
<p>Top View</p>	KA1 or KA3	KA1 or KA3 #2	1	0	0	1	0	0	0	0	1	1	0	0
	KA2	KA2 #2	0	1	1	0	0	1	0	1	0	0	1	0
	KA1 or KA3	KA1 or KA3 #1	0	0	1	1	0	0	0	1	0	0	1	1
	KA2	KA2 #1	1	1	0	0	0	1	0	1	0	0	1	0
Cam (see page 47)			B	C	D	E	F	G	J	L	M			

Non-Illuminated Operators

Manual Return, Operator Only (without contact blocks) (1)									
Without Knob	SKS42	SKS43	SKS44	SKS45	SKS46	SKS47	SKS49	SKS401	SKS402
With Knob (select style and color from table below)	SKS42♦	SKS43♦	SKS44♦	SKS45♦	SKS46♦	SKS47♦	SKS49♦	SKS401♦	SKS402♦
Operator with Contact Blocks and Standard black knob (4)									
With 1 KA1 on Side #2 (H13)	SKS42BH13	SKS43BH13	SKS44BH13	SKS45BH13	SKS46BH13	SKS47BH13	SKS49BH13	SKS401BH13	SKS402BH13
With 1 KA1 on Side #1 (H1)	SKS42BH1	SKS43BH1	SKS44BH1	SKS45BH1	SKS46BH1	SKS47BH1	SKS49BH1	SKS401BH1	SKS402BH1
With 1 KA1 on Side #1 and 1 KA1 on side #2 (H2)	SKS42BH2	SKS43BH2	SKS44BH2	SKS45BH2	SKS46BH2	SKS47BH2	SKS49BH2	SKS401BH2	SKS402BH2
Spring Return from Left to Center, Operator Only (without contact blocks) (1)									
Without Knob	SKS62	SKS63	SKS64	SKS65	SKS66	SKS67	SKS69	SKS601	SKS602
With Knob (select style and color from table below)	SKS62♦	SKS63♦	SKS64♦	SKS65♦	SKS66♦	SKS67♦	SKS69♦	SKS601♦	SKS602♦
Spring Return from Right to Center, Operator Only (without contact blocks) (1)									
Without Knob	SKS72	SKS73	SKS74	SKS75	SKS76	SKS77	SKS79	SKS701	SKS702
With Knob (select style and color from table below)	SKS72♦	SKS73♦	SKS74♦	SKS75♦	SKS76♦	SKS77♦	SKS79♦	SKS701♦	SKS702♦
Spring Return from Both Sides to Center, Operator Only (without contact blocks) (1)									
Without Knob	SKS52	SKS53	SKS54	SKS55	SKS56	SKS57	SKS59	SKS501	SKS502
With Knob (select style and color from table below)	SKS52♦	SKS53♦	SKS54♦	SKS55♦	SKS56♦	SKS57♦	SKS59♦	SKS501♦	SKS502♦

Illuminated Operators

Manual Return, Operator Only (without contact blocks) (1)									
Without Knob, 110-120V 50-60 Hz Transformer	SK42J1	SK43J1	SK44J1	SK45J1	SK46J1	SK47J1	SK49J1	SK401J1	SK402J1
With Standard Red Knob, 110-120V 50-60 Hz Transformer	SK42J1R	SK43J1R	SK44J1R	SK45J1R	SK46J1R	SK47J1R	SK49J1R	SK401J1R	SK402J1R
With Other Color Knob and other voltage Light Module (2) (3)	SK42J■♦	SK43J■♦	SK44J■♦	SK45J■♦	SK46J■♦	SK47J■♦	SK49J■♦	SK401J■♦	SK402J■♦
Spring Return from Left to Center, Operator Only (without contact blocks) (1)									
Without Knob, 110-120V 50-60 Hz Transformer	SK62J1	SK63J1	SK64J1	SK65J1	SK66J1	SK67J1	SK69J1	SK601J1	SK602J1
With Standard Red Knob, 110-120V 50-60 Hz Transformer	SK62J1R	SK63J1R	SK64J1R	SK65J1R	SK66J1R	SK67J1R	SK69J1R	SK601J1R	SK602J1R
With Other Color Knob and other voltage Light Module (2) (3)	SK62J■♦	SK63J■♦	SK64J■♦	SK65J■♦	SK66J■♦	SK67J■♦	SK69J■♦	SK601J■♦	SK602J■♦
Spring Return from Right to Center, Operator Only (without contact blocks) (1)									
Without Knob, 110-120V 50-60 Hz Transformer	SK72J1	SK73J1	SK74J1	SK75J1	SK76J1	SK77J1	SK79J1	SK701J1	SK702J1
With Standard Red Knob, 110-120V 50-60 Hz Transformer	SK72J1R	SK73J1R	SK74J1R	SK75J1R	SK76J1R	SK77J1R	SK79J1R	SK701J1R	SK702J1R
With Other Color Knob and other voltage Light Module (2) (3)	SK72J■♦	SK73J■♦	SK74J■♦	SK75J■♦	SK76J■♦	SK77J■♦	SK79J■♦	SK701J■♦	SK702J■♦
Spring Return from Both Sides to Center, Operator Only (without contact blocks) (1)									
Without Knob, 110-120V 50-60 Hz Transformer	SK52J1	SK53J1	SK54J1	SK55J1	SK56J1	SK57J1	SK59J1	SK501J1	SK502J1
With Standard Red Knob, 110-120V 50-60 Hz Transformer	SK52J1R	SK53J1R	SK54J1R	SK55J1R	SK56J1R	SK57J1R	SK59J1R	SK501J1R	SK502J1R
With Other Color Knob and other voltage Light Module (2) (3)	SK52J■♦	SK53J■♦	SK54J■♦	SK55J■♦	SK56J■♦	SK57J■♦	SK59J■♦	SK501J■♦	SK502J■♦

- ▲ These operators can be ordered complete with contact blocks. Add the “H code” from page 51 as needed for your application.
- Replace ■ with the voltage assembly code as chosen from the tables on page 54. Example: K25J■ with 208Vac = K25J3.
- ♦ Replace ♦ with the color code as chosen from the color code table below. For LED, knob color must match LED.
- ★ For other color knobs replace the B with knob color code from table below.

Selector Switch Assembly Code and Knob Cat. No.

Color	Standard Knob		Gloved Hand Knob	
	◆ Knob Code	Reference	◆ Knob Code	Reference
Black	B	B11	FB	B25
Red	R	R8	FR	R24
Green	G	G8	FG	G24
Yellow	Y	Y8	FY	Y24
Blue	L	L8	FL	L24
White	W	W8	FW	W24
Amber	A	A8	FA	A24
Clear	C	C8	FC	C24



To select and order Contact Blocks, Light Modules, Knobs, and Accessories, see pages 50 to 59.

Harmony™ 9001K/SK/KX

30 mm push buttons

9001SK – Selector switches

Note: When ordering, add prefix “9001” to the reference.

4-Position Selector Switches				
Contact Block Required and Position	Quantity and Type	Mount on Side	1 — Contact Closed 0 — Contact Open	
<p>Top View</p>	KA1 or KA3	KA1 or KA3 #2	1 0 0 0	
		KA2	KA2 #2	0 0 1 0
	KA1 or KA3	KA1 or KA3 #1	0 0 0 1	
		KA2 #1	0 1 0 0	
Cam (see page 47)			H	

Non-Illuminated Operators

Manual Return (1), Operator Only (without contact blocks)	Reference
Without Knob	SKS88
With Knob (3)	SKS88♦

Illuminated Operators

Manual Return (1), Operator Only (without contact blocks)	Reference
Without Knob, 110-120V 50-60 Hz Transformer	SK88J1
With Standard Red Knob, 110-120V 50-60 Hz Transformer	SK88J1R
With Other Color Knob and other voltage Light Module (2) (3)	SK88J■♦

(1) These operators can be ordered complete with contact blocks. Add the “H code” from page 51 as needed for your application.
 (2) Replace ■ with the voltage assembly code as chosen from the tables on page 54. Example: K25J■ with 208Vac = K25J3
 (3) Replace ♦ with the color code as chosen from the color code table below. For LED, knob color must match LED.

Selector Switch Assembly Code and Knob Cat. No.

Color	Standard Knob		Gloved Hand Knob	
	◆ Knob Code	Reference	◆ Knob Code	Reference
Black	B	B11	FB	B25
Red	R	R8	FR	R24
Green	G	G8	FG	G24
Yellow	Y	Y8	FY	Y24
Blue	L	L8	FL	L24
White	W	W8	FW	W24
Amber	A	A8	FA	A24
Clear	C	C8	FC	C24



Potentiometer with Dial Plate (not UL listed)—Maximum Voltage 300 Vac



Power	Description	Ratings	Reference
2 W	Operator Only, for Single Potentiometer	NEMA 4, 13	SK20
	Operator with Single Potentiometer		SK21
	Operator Only, for Tandem Potentiometer		SK22
	Operator with Tandem Potentiometer		SK23

Potentiometer Suffixes

Single Potentiometer			
Suffix (4)	Resistance	Suffix (4)	Resistance
01	50 Ω	07	5 kΩ
02	100 Ω	08	10 kΩ
04	500 Ω	09	25 kΩ
05	1 kΩ	13	500 kΩ
39	2 kΩ	37	750 kΩ
06	2.5 kΩ	14	1 MΩ
Tandem Potentiometer			
Suffix (4)	Resistance		
	Front	Rear	
82	1 kΩ	1 kΩ	

(4) For the complete reference, add the suffix from Suffix column to the reference from Reference column in “Potentiometer with Dial Plate” table above. Example: 9001 SK21 05.

Note: Any potentiometer with a shaft 7/8" long and 1/4" diameter may be used with these operators
 Note: To select and order Contact Blocks, Light Modules, Knobs, and Accessories, see pages 50 to 59.

Harmony™ 9001K/SK/KX

30 mm push buttons

9001SK – Selector switch guide

Note: When ordering, add prefix “9001” to the reference.

Shown below is a simplified method of selecting a selector switch to meet almost any combination of contact sequences.

Step No. 1

Determine the contact sequence(s) required. Set up a target table like the one shown for the example below.

Contact Sequence	0—contact open	1—contact closed	↖	↑	↗
A			1	0	0
B			0	1	0
C			0	0	1

Step No. 2

Look for a cam type common to all sequences in the three tables to the right. For the example above, the “3-Position Selector Switch” table would be used. For the contact sequences A (1 0 0), B (0 1 0) and C (0 0 1) of the example above, cam types F and L are common to all three sequences.

Step No. 3

Next, use the cam type common to all the sequences (if several cam types are common, choose one) to find the operator reference number. Go to the proper page number as indicated in the table below:

Number of Positions	Push Button Line	Page Number
2	9001SKS	44
3	9001SKS	45
4	9001SKS	46

If for the example above a manual return operator with a standard black knob is required and:

The F cam type is chosen, the operator reference number is:

- 9001SK—9001SKS46B (from page 45)

The L cam type is chosen, the operator reference number is:

- 9001SK—9001SKS401B (from page 45)

Step No. 4

Determine the contact blocks required by using the same table in Step No. 2.

If, for the example above, the F cam type is chosen:

- Use a 9001KA3 mounted on side no. 2 for sequence A (1 0 0).
- Use a 9001KA3 mounted on side no. 1 for sequence B (0 1 0).
- Use a 9001KA2 mounted on side no. 1 or 2 for sequence C (0 0 1).

If, for the example above, the L cam type is chosen:

- Use a 9001KA2 mounted on side no. 2 for sequence A (1 0 0).
- Use a 9001KA2 mounted on side no. 1 or a 9001KA3 mounted on side no. 2 for sequence B (0 1 0).
- Use a 9001KA3 mounted on side no. 1 for sequence C (0 0 1).

One 9001KA1 double circuit block can be used in place of one 9001KA2 single circuit block plus one 9001KA3 single circuit block mounted on the same side.

2-Position Selector Switch

If you require contact sequence—	Use Cam Type	Use Contact Block Reference	Mount on side no. (See page 51)
1 0	E	KA3	1 or 2
	D	KA2	1 or 2
0 1	E	KA2	1 or 2
	D	KA3	1 or 2

3-Position Selector Switch

If you require contact sequence—	Use Cam Type	Use Contact Block Reference	Mount on side no. (See page 51)
1 0 0	G M	KA2	1
	L	KA2	2
	C E	KA3	1
	B C E F G J	KA3	2
	B G J	KA5 (1)	2
0 1 0	D E J L	KA2	1
	D E	KA2	2
	F	KA3	1
	L	KA3	2
0 0 1	C F	KA2	1 or 2
	B D G L	KA3	1
	D	KA3	2
	B	KA5 (1)	1
	M	KA2	2
1 1 0	C F	KA5 (1)	1 or 2
	M	KA3	2
0 1 1	B G J L	KA2	2
	G J	KA5 (1)	1
	L	KA5 (1)	2
	M	KA3	1
1 0 1	J L	KA3	1
	D E J L	KA5 (1)	1
	D E	KA5 (1)	2

4-Position Selector Switch

If you require contact sequence—	Use Cam Type	Use Contact Block Reference	Mount on side no. (See page 51)
1 0 0 0	H	(A) KA3	2
0 1 0 0	H	(B) KA2	1
0 0 1 0	H	(C) KA2	2
0 0 0 1	H	(D) KA3	1
1 0 0 1	H	A & D Wired in Parallel	
1 1 0 0	H	A & B Wired in Parallel	
0 1 1 0	H	B & C Wired in Parallel	
0 0 1 1	H	C & D Wired in Parallel	
1 1 1 0	H	A, B & C Wired in Parallel	
0 1 1 1	H	B, C & D Wired in Parallel	
1 0 1 0	H	A & C Wired in Parallel	
0 1 0 1	H	B & D Wired in Parallel	
1 1 0 1	H	KA5 (1)	2
1 0 1 1	H	KA5 (1)	1

(1) 9001KA5 must be the last block on either side.



When ordering, please specify:

- Quantity
- Class Number
- Type or Reference

For “H” Numbers, see page 51.

Harmony™ 9001K/SK/KX

30 mm push buttons

9001SK – Pilot lights

Note: When ordering, add prefix “9001” to the reference.

Pilot Lights—UL Types 4, 4X, 13/NEMA 4, 4X, 13
For use in hazardous locations, see page 53. Legend plate not included.

Description	Voltage	Style	With Red Fresnel Color Cap	With Green Fresnel Color Cap	With Other Color Cap (2)	Without Color Cap
 Standard Pilot Light (Fresnel color cap shown)	110–120 V, 50–60 Hz Transformer	Transformer	SKP1R31	SKP1G31	SKP1■	SKP1
	220–240 V, 50–60 Hz Transformer	Transformer	SKP7R31	SKP7G31	SKP7■	SKP7
	24–28 Vac/Vdc	Full Voltage	SKP35R31	SKP35G31	SKP35■	SKP35
	For other voltages (1)	Transformer, Flashing or LED (3)	SKP▲R31	SKP▲G31	SKP▲■	SKP▲
 Push-To-Test Pilot Light (Fresnel color cap shown)	110–120 V, 50–60 Hz Transformer	Transformer	SKT1R31	SKT1G31	SKT1■	SKT1
	220–240 V, 50–60 Hz Transformer	Transformer	SKT7R31	SKT7G31	SKT7■	SKT7
	24–28 Vac/Vdc	Full Voltage	SKT35R31	SKT35G31	SKT35■	SKT35
	For other voltages (1)	92% Full Voltage, Neon or Resistor (4)	SKT▲R31	SKT▲G31	SKT▲■	SKT▲
 Remote Test Pilot Light (Fresnel color cap shown)	120 Vac Only	Resistor	SKTR38R31	SKTR38G31	SKTR38■	SKTR38
	24–28 Vac Only	Full Voltage	SKTR35R31	SKTR35G31	SKTR35■	SKTR35
	For other voltages (1)	Full Voltage or Resistor (5)	SKTR▲R31	SKTR▲G31	SKTR▲■	SKTR▲

- (1) Replace ▲ with the voltage assembly code as chosen from the tables on page 54. Example: SKT▲R31 with 208 Vac red LED voltage = SKT37LRR31.
- (2) Replace ■ with the color code as chosen from the color code table below. Example: SKP1■ with a blue fresnel cap = SKP1L31.
- (3) The cap must be the same color as the LED light module chosen, e.g., for a green LED, use a green color cap.
- (4) On neon light modules, use clear color caps only.
- (5) Use only full voltage or resistor voltage assembly codes on remote test pilot lights. Do not choose LED, neon or transformer codes. For AC use only.

Color Caps

Color	■ Plastic Fresnel	■ Plastic Domed
Amber	A31	A9
Blue	L31	L9
Clear	C31	C9
Green	G31	G9
Red	R31	R9
White	W31	W9
Yellow	Y31	Y9

Typical Wiring Diagrams



Push-to-test Pilot Light



Remote Test Pilot Light

To select and order Contact Blocks, Light Modules, Knobs, and Accessories, see pages 50 to 59.

Harmony™ 9001K/SK/KX

30 mm push buttons

9001SK – Specialty operators

Note: When ordering, add prefix “9001” to the reference.

Specialty Operators—UL Types 4, 4X, 13/NEMA 4, 4X, 13

For use in hazardous locations, see page 53.

Legend plate and contact blocks not included unless otherwise noted.

Interlocked Assembly	Description	Color	Contacts	Without Contacts
	Interlocked Assembly Both Buttons Maintained	Universal (1)	SKR11UH1	SKR11U
		Other (2)	SKR11■H1	SKR11■
	Interlocked Assembly One Button Momentary	Universal (1)	SKR12UH1H1	SKR12U
	Interlocked Assembly One Button Maintained	Other (2)	SKR12■H1H1	SKR12■

9001SKR11U

(1) Universal for SKR11, 12 includes 2 each of black, red, green, yellow, orange, blue, white.

(2) Replace ■ with the color code as chosen from the following: B = black, R = red, G = green, L = blue, Y = yellow, W = white, S = orange, E = gray.
Example: An SKR11 with top button gray and bottom button orange = SKR11ES

Harmony™ 9001K/SK/KX

30 mm push buttons

9001SK – Contact blocks

Note: When ordering, add prefix “9001” to the reference.

The 9001KA contact blocks are Fingersafe™ contact blocks (meeting VDE 0106 Part 100 Standard). They have one screw mounting and captive (backed out) plus/minus terminal screws. These contact blocks are double-break, direct-acting contacts. Because of the wiping action of these contacts, they are suitable for use with programmable controllers. All contact blocks listed below accept up to 2 #12–#24 AWG solid or stranded wires. Recommended tightening torque for screw terminals is 7 lb-in.

Standard Contact Blocks

Description	Symbol	Reference
(Clear Cover)	 Direct-Acting	KA1
(Green Cover)		KA2
(Red Cover)	 Direct-Acting	KA3
(Clear Cover)	 N.O. Contact Early Closing	KA4
(Red Cover)	 N.C. Contact Late Opening	KA5
(Green Cover)	 N.O. Contact Early Closing	KA6

Additional Circuit Arrangements

Sequencing (1) N.O. Contact of KA4 closes before N.O. Contact on KA1		Order One9001KA4 and One 9001KA1
Overlapping (1) N.O. Contact of KA4 closes before N.C. Contact of KA5 opens		Order One9001KA4 and One 9001KA5

(1) For push buttons or two-position selector switches only. For sequencing or overlapping contacts on other operators, refer to catalog 9001CT0001.

Symbol	Contact Blocks with Binder Head Screws (not Fingersafe) Reference	Quantity (2)	Gold Flashed Contacts with Standard Pressure Wire Terminals Reference
	KA21	25–Up	KA31
	KA22	25–Up	KA32
	KA23	25–Up	KA33
 N.O. Early Closing	KA24	25–Up	KA34
 N.C. Contact Late Opening	KA25	25–Up	KA35

(2) Minimum order quantity is 25.

Contact blocks listed below are not Fingersafe, but provide:

- Terminals that accept ring tongue/fork tongue connectors
- Short single circuit contact blocks (0.75” deep vs. 0.97” deep on the Fingersafe)
- For assembled operators, use form Y238 (add to reference as suffix, for example: 9001KRU1H13Y238)



Contact blocks (not Fingersafe)

Symbol	Reference	Symbol	Reference
	KA1G	 N.O. Contact Early Closing	KA4G
	KA2G	 N.C. Contact Late Opening	KA5G
	KA3G	 N.O. Contact Early Closing	KA6G

Contact blocks with Quick-Connect terminals (not Fingersafe)

Symbol	Reference
	KA12
	KA13

For dimensions, refer to catalog 9001CT0001

Maximum Current Ratings for Control Circuit Contacts—9001KA1–KA6, KA21–KA25, KA31–KA35, KA1G–KA6G

V	AC						V	DC				
	Inductive (NEMA / UL Type A600) 35% Power Factor					Resistive 75% Power Factor Make, Break and Continuous Amperes		Inductive and Resistive (NEMA Q600)				
	Make		Break		Continuous Carrying Amperes			Make and Break			Continuous Carrying Amperes	
	Amperes	VA	Amperes	VA				KA1	KA2 KA3	KA4		KA5 KA6
120	60	7200	6.0	720	10	10	125	0.55	0.55	—	—	2.5
240	30		250				0.27	0.27	—	—		
480	15		600				0.10	0.10	—	—		
600	12											

To select and order Contact Blocks, Light Modules, Knobs, and Accessories, see pages 50 to 59.

Harmony™ 9001K/SK/KX 30 mm push buttons 9001SK – Contact blocks

Note: When ordering, add prefix “9001” to the reference.

Contact Block “H” Codes

The design of the 9001KA contact blocks allows them to be mounted side by side and/or in tandem. This enables you to specify an operator and a particular arrangement of contact blocks (shipped completely assembled) with a single reference number. See page 50 for a description of contact blocks.



Example: A 9001KR1B push button with 2 9001KA1 contact blocks would be 9001KR1BH2.

Suffix No. (Add to Operator Reference)	Positions					
	1	2	3	4	5	6
H1	KA1					
H2	KA1	KA1				
H3	KA1	KA1	KA1			
H4	KA1	KA1	KA1	KA1		
H5	KA2					
H6	KA3					
H7	KA2	KA2				
H8	KA3	KA3				
H9	KA4	KA1				
H10	KA4	KA5				
H11	KA1	KA1		KA1		
H12	KA2	KA3	KA2	KA3		
H13		KA1				
H14		KA3				
H15	KA2	KA3	KA2			
H16	KA2	KA3		KA3		
H17	KA1	KA1	KA2			
H18	KA3	KA1	KA3		KA3	
H19	KA1	KA1	KA1	KA1	KA1	
H21	KA2	KA3				
H23	KA1	KA1	KA1	KA1	KA1	KA1
H24	KA1	KA2				
H25	KA5	KA3				

Note: For “H” Codes not shown in this table, contact your local Schneider Electric representative.

Dimensions When Using Contact Blocks



Maximum Contact Block Usage:

2 blocks mounted side by side only: Any 2, 3 or 4-Position spring return selector switch (non-illuminated, illuminated or keyed).

2 blocks mounted in tandem on one side only: Any 2 operator interlocked push button.

2 blocks mounted in tandem (total of four blocks): Any selector push button, keyed push button, 2, 3, or 4-Position maintained selector switch (non-illuminated, illuminated or keyed), push pull operators (non-illuminated or illuminated), joy stick, dual push button.

3 blocks mounted in tandem (total of six blocks): Single momentary push buttons (non-illuminated or illuminated).

Harmony™ 9001K/SK/KX 30 mm push buttons 9001SK – Contact blocks

Note: When ordering, add prefix “9001” to the reference.

Mounting Hole for All 9001SK Control Units



Hole Punch: Use Greenlee Tool #60242 to punch mounting hole and notch.

Maximum Contact Block Usage:

- **2 blocks mounted side by side only:** Any 2, 3 or 4-Position **spring return** selector switch (non-illuminated, illuminated or keyed).
- **2 blocks mounted in tandem on one side only:** Any 2 operator interlocked push button.
- **2 blocks mounted in tandem (total of four blocks):** Any selector push button, keyed push button, 2, 3, or 4-Position **maintained** selector switch (non-illuminated, illuminated or keyed), push-pull operators (non-illuminated or illuminated), joy stick, dual push button.
- **3 blocks mounted in tandem (total of six blocks):** Single momentary push buttons (non-illuminated or illuminated).



Min. Centerline Spacing, 9001SK Control Units

Legend Plate	Operator	Centerline Spacing (in)					
		A	B	C	D	E	F
Legend Plate Orientation Position #1							
KN2	Standard Push Button	1.75	1.31	1.44	2.25	1.69	0.88
	1.375 in Dia. Mushroom	1.75	1.31	1.44	2.25	1.69	0.88
	2.25 in Dia. Mushroom	2.25	1.31	1.44	2.25	2.25	1.12
	Selector Switch Knobs	1.75	1.31	1.44	2.25	1.69	0.88
KN3	Standard Push Button	2.00	1.31	1.44	2.25	1.75	0.88
	1.375 in Dia. Mushroom	2.00	1.31	1.44	2.25	1.75	0.88
	2.25 in Dia. Mushroom	2.25	1.31	1.44	2.25	2.25	1.12
	Selector Switch Knobs	2.00	1.31	1.44	2.25	1.75	0.88
KN4	Standard Push Button	1.94	1.31	1.44	2.25	1.62	0.88
	1.375 in Dia. Mushroom	1.94	1.31	1.44	2.25	1.62	0.88
	2.25 in Dia. Mushroom	2.25	1.31	1.44	2.25	2.25	1.12
	Selector Switch Knobs	1.74	1.31	1.44	2.25	1.62	0.88
KN6	Standard Push Button	2.38	1.62	1.44	2.25	2.25	1.12
	1.375 in Dia. Mushroom	2.38	1.62	1.44	2.25	2.25	1.12
	2.25 in Dia. Mushroom	2.38	1.62	1.44	2.25	2.25	1.12
	Selector Switch Knobs	2.38	1.62	1.44	2.25	2.25	1.12

Legend Plate	Operator	Centerline Spacing (in)					
		A	B	C	D	E	F
Legend Plate Orientation Position #2							
KN2	Standard Push Button	1.62	1.31	1.44	2.25	1.75	0.88
	1.375 in Dia. Mushroom	1.62	1.31	1.44	2.25	1.75	0.88
	2.25 in Dia. Mushroom	2.25	1.31	1.44	2.25	2.25	1.12
	Selector Switch Knobs	1.62	1.31	1.44	2.25	1.75	0.88
KN3	Standard Push Button	1.75	1.31	1.44	2.25	2.00	0.88
	1.375 in Dia. Mushroom	1.75	1.31	1.44	2.25	2.00	0.88
	2.25 in Dia. Mushroom	2.25	1.31	1.44	2.25	2.25	1.12
	Selector Switch Knobs	1.75	1.31	1.44	2.25	2.00	0.88
KN4	Standard Push Button	1.62	1.31	1.44	2.25	1.94	1.00
	1.375 in Dia. Mushroom	1.62	1.31	1.44	2.25	1.94	1.00
	2.25 in Dia. Mushroom	2.25	1.31	1.44	2.25	2.25	1.12
	Selector Switch Knobs	1.62	1.31	1.44	2.25	1.94	1.00
KN6	Standard Push Button	2.25	1.31	1.62	2.38	2.38	0.88
	1.375 in Dia. Mushroom	2.25	1.31	1.62	2.38	2.38	0.88
	2.25 in Dia. Mushroom	2.25	1.31	1.62	2.38	2.38	1.12
	Selector Switch Knobs	2.25	1.31	1.62	2.38	2.38	0.88

Harmony™ 9001K/SK/KX

30 mm push buttons

9001SK – Contact blocks

Note: When ordering, add prefix “9001” to the reference.

Hazardous locations do not always require the use of explosion-proof equipment like the 9001BR control stations. Selecting the most appropriate device for the location can save you money. For more information on the types of hazardous locations, contact your local electrical inspector.

Schneider Electric Offering According to Class, Division, and Group

For Class	Division	Group(s)	Use
I	1	A	1. Intrinsically Safe System
I	1	B, C, D	1. 9001BR station 2. Intrinsically Safe System
I	2	A	1. 9001SK control stations with restrictions (1) 2. Intrinsically Safe System
I	2	B, C, D	1. 9001BR station 2. 9001SK control stations with restrictions (1) 3. Intrinsically Safe System
II	1	E, F, G	1. 9001BR station 2. Intrinsically Safe System
II	2	E, F	1. 9001BR station 2. 9001SK control stations with restrictions (1) 3. Intrinsically Safe System
II	2	G	1. 9001BR station 2. 9001SK control stations with restrictions (2) 3. Intrinsically Safe System
III	1, 2	—	1. 9001BR Station 2. 9001SK control stations with restrictions (2) 3. Intrinsically Safe System

Any 9001SK operator can be used in an area classified as Class I, Division 2 hazardous locations, if:

- Only logic (KA40 series) or power (KA50 series) reed contact blocks are used.
- All 9001SK illuminated operators are UL approved for use in Class I Division 2 areas.
- The operators are mounted in any NEMA 4 & 13 enclosures.

(1) Any 9001SK operator mounted in a 9001KY, 9001KYSS, 9001KYAF or 9001SKY enclosure may be used, except potentiometer operators.

(2) Add Form Y243 to single lamp Push-To-Test pilot lights.

Note: For (1) and (2): UL Listed: File E10054(N), CCN NOIV.

Hazardous Locations:



File E10054(N)
CCN NOIV



File Class LR26817
3218 02

Hermetically Sealed Logic Reed Contact Blocks Suitable for use on low energy level circuits

Description	Symbol	Reference
		KA41
		KA42
		KA43
		KA44
		KA45

Max. Vac/Vdc	Maximum Load		
	Resistive	Inductive	Continuous
32/30	.25 A	.10 A	.5 A
120/100	8 VA	3 VA	.5 A

The maximum number of logic and/or power reed contact blocks per operator is as indicated on individual selection tables for standard contact blocks, **except**:

- On 3-Position selector switches with cams C, D, E, F, G, L, or M, mount reed blocks on **one side only** (either side), maximum 2 in tandem.
- On 4-Position selector switches, mount reed blocks on **one side only** (either side), maximum 2 in tandem.
- On joysticks or on 9001SKR8 push-pull operators, mount reed blocks on **one side only** (either side), maximum 2 in tandem.

Hermetically Sealed Power Reed Contact Blocks (5)

Description	Symbol	Reference
		KA51
		KA52
		KA53
		KA54
		KA55

Volts	AC NEMA C300 (3)				Continuous Carrying Amperes
	Make		Break		
	A	VA	A	VA	
120	10.00	1200	1.000	120	3.0
240	5.00		.500		

Volts	DC NEMA Q150 (4)				Continuous Carrying Amperes
	Make		Break		
	A	VA	A	VA	
115	.50	58	.50	58	3.0

Note: All contact blocks listed above accept #12–18 solid or stranded wire.

The power reed contact blocks can be used with standard industrial relays and starters through NEMA Size 4. Minimum voltage is 5 V and the minimum current is 1 mA.

(3) Inductive Rating—35% Power Factor.

(4) Inductive and Resistive Ratings

(5) Not for use in pendant stations.

Harmony™ 9001K/SK/KX

30 mm push buttons

9001SK – Light modules

Note: When ordering, add prefix “9001” to the reference.



Standard Light Modules for 9001SK Control Units (1)					
Voltage	Description	Light Module Reference	Voltage Assembly Code	Rating	Replacement Lamp Reference
All	Full Voltage (without Bayonet Base Lamp)	KM40	40	—	no lamp included
6 Vac/Vdc	Full Voltage	KM31	31	.9 VA	2550101020
6 Vac/Vdc	LED Red	KM31LR	31LR		6508805201
6 Vac/Vdc	LED Green	KM31LG	31LG		6508805203
6 Vac/Vdc	LED Yellow	KM31LY	31LY		6508805202
12–14 Vac/Vdc	Full Voltage	KM32	32	1.2 VA	2550101037
12–14 Vac/Vdc	LED Red	KM32LR	32LR		6508805201
12–14 Vac/Vdc	LED Green	KM32LG	32LG		6508805203
12–14 Vac/Vdc	LED Yellow	KM32LY	32LY		6508805202
18 Vac/Vdc	Resistor	KM33	33	1.4 VA	2550101037
24–28 Vac/Vdc	Full Voltage	KM35	35	1.2 VA	2550101002
24–28 Vac/Vdc	LED Red	KM35LR	35LR	.28 VA	6508805210
24–28 Vac/Vdc	LED Green	KM35LG	35LG	.28 VA	6508805212
24–28 Vac/Vdc	LED Yellow	KM35LY	35LY	.28 VA	6508805211
24–28 Vac/Vdc	LED White	KM35LW	35LW	.28 VA	6508805214
24–28 Vac/Vdc	LED Blue	KM35LL	35LL	.28 VA	6508805213
48 Vac/Vdc	Full Voltage	KM36	36	2.6 VA	2550101025
110–120 V, 50–60 Hz	LED Red	KM1LR	1LR		6508805201
110–120 V, 50–60 Hz	LED Green	KM1LG	1LG		6508805203
110–120 V, 50–60 Hz	LED Yellow	KM1LY	1LY		6508805202
110–120 V, 50–60 Hz	Transformer	KM1	1	2.4 VA	2550101020
110–120 V, 50–60 Hz	Flashing	KMF1	F1	.85 VA	2550101036
120 Vac/Vdc	Resistor	KM38	38	3.0 VA	2550101027
120 Vac/Vdc	Full Voltage	KM38	38	3.0 VA	2550101027
120 Vac/Vdc	Neon	KM11	11	0.2 VA	2550101013
120 Vac/Vdc	LED Red	KM38LR	38LR	1.4 VA	6508805210
120 Vac/Vdc	LED Green	KM38LG	38LG	1.4 VA	6508805212
120 Vac/Vdc	LED Yellow	KM38LY	38LY	1.4 VA	6508805211
120 Vac/Vdc	LED White	KM38LW	38LW	1.4 VA	6508805214
120 Vac/Vdc	LED Blue	KM38LL	38LL	1.4 VA	6508805213
208–220 V, 50–60 Hz	Transformer	KM3	3	2.5 VA	2550101020
208–220 V, 50–60 Hz	LED Red	KM3LR	3LR		6508805201
208–220 V, 50–60 Hz	LED Green	KM3LG	3LG		6508805203
208–220 V, 50–60 Hz	LED Yellow	KM3LY	3LY		6508805202
208–220 V, 50–60 Hz	LED White	KM3LW	3LW		6508805215
208–220 V, 50–60 Hz	LED Blue	KM3LL	3LL		6508805216
220–240 V, 50–60 Hz	Transformer	KM7	7	2.0 VA	2550101020
220–240 V, 50–60 Hz	LED Red	KM7LR	7LR		6508805201
220–240 V, 50–60 Hz	LED Green	KM7LG	7LG		6508805203
220–240 V, 50–60 Hz	LED Yellow	KM7LY	7LY		6508805202
220–240 V, 50–60 Hz	LED White	KM7LW	7LW		6508805215
220–240 V, 50–60 Hz	LED Blue	KM7LL	7LL		6508805216
240 Vac/Vdc	Resistor	KM25	25	6.0 VA	2550101027
240 Vac/Vdc	Neon	KM12	12	0.3 VA	2550101013
277 V, 50–60 Hz	Transformer	KM8	8	2.4 VA	2550101020
380–480 V, 50–60 Hz	Transformer	KM5	5	2.8 VA	2550101020
480 Vac/Vdc	Neon	KM14	14	0.5 VA	2550101013
550–600 V, 50–60 Hz	Transformer	KM6	6	2.5 VA	2550101020

(1) For use with all operators except KX and remote test pilot.

Notes: Light modules are available in other voltages, as shown above. For use in hazardous locations, see page 53. With neon type light modules, use a clear color cap only. With LED light modules, use either a clear color cap or a cap the same color as the LED.



Shallow Depth Light Modules For 9001SK Control Units (2)					
Voltage	Description	Light Module Reference	Voltage Assembly Code	Rating	Replacement Lamp Reference
24–28 Vac/Vdc	Full Voltage	KM55	55	1.2 VA	2550101002
	LED Red	KM55LR	55LR	0.5 VA	6508805204
	LED Green	KM55LG	55LG		6508805206
	LED Yellow	KM55LY	55LY		6508805205
110–120 Vac/Vdc	Full Voltage	KM58	58	3.0 VA	2550101027
	LED Red	KM58LR	58LR	0.5 VA	6508805204
	LED Green	KM58LG	58LG		6508805206
	LED Yellow	KM58LY	58LY		6508805205

(2) For use with all operators except KX and remote test pilot.

Notes: For use in hazardous locations, see page 53. Reduces the depth of illuminated push buttons with contact blocks by over 33%. With LED light modules, use a cap that is the same color as the LED.



File
CCN

E42259
NKCR



File
Class

LR25490
3211 03





marked

Harmony™ 9001K/SK/KX

30 mm push buttons

9001SK – Legend plates

Note: When ordering, add prefix “9001” to the reference.

Legend Plates												
Standard Markings	Plastic Legend Plates for use with 9001SK Operators									Aluminum Legend Plates for use with 9001K Operators		
	1-3/4" Square			2-1/4" Square			2-1/2" Square			Black Legend	Black Legend	Blue Legend
	Silver Legend w/ Black Letters	White Legend w/ Black Letters	Black Legend w/ White Letters	Silver Legend w/ Black Letters	White Legend w/ Black Letters	Black Legend w/ White Letters	Silver Legend w/ Black Letters	White Legend w/ Black Letters	Black Legend w/ White Letters			
For Push Button or Pilot Light												
Blank	KN200SP	KN200WP	KN200BP	KN100SP	KN100WP	KN100BP	KN700SP	KN700WP	KN700BP	KN200	KN300	KN800
Blank (red)	KN200RP (2)	KN200RP (2)	KN200RP (2)	KN100RP (2)	KN100RP (2)	KN100RP (2)	KN700RP (2)	KN700RP (2)	KN700RP (2)	KN200R (1)	KN300R (1)	KN800R (1)
Start	KN201SP	KN201WP	KN201BP	KN101SP	KN101WP	KN101BP	KN701SP	KN701WP	KN701BP	KN201	KN301	KN801
Stop	KN202RP (2)	KN202RP (2)	KN202RP (2)	KN102RP (2)	KN102RP (2)	KN102RP (2)	KN702RP (2)	KN702RP (2)	KN702RP (2)	KN202 (1)	KN302 (1)	KN802 (1)
On	KN203SP	KN203WP	KN203BP	KN103SP	KN103WP	KN103BP	KN703SP	KN703WP	KN703BP	KN203	KN303	KN803
Off	KN204RP (2)	KN204RP (2)	KN204RP (2)	KN104RP (2)	KN104RP (2)	KN104RP (2)	KN704RP (2)	KN704RP (2)	KN704RP (2)	KN204 (1)	KN304 (1)	KN804 (1)
Emerg. Stop	KN205RP (2)	KN205RP (2)	KN205RP (2)	KN105RP (2)	KN105RP (2)	KN105RP (2)	KN705RP (2)	KN705RP (2)	KN705RP (2)	KN205 (1)	KN305 (1)	KN805 (1)
Forward	KN206SP	KN206WP	KN206BP	KN106SP	KN106WP	KN106BP	KN706SP	KN706WP	KN706BP	KN206	KN306	KN806
Reverse	KN207SP	KN207WP	KN207BP	KN107SP	KN107WP	KN107BP	KN707SP	KN707WP	KN707BP	KN207	KN307	KN807
Close	KN208SP	KN208WP	KN208BP	KN108SP	KN108WP	KN108BP	KN708SP	KN708WP	KN708BP	KN208	KN308	KN808
Open	KN209SP	KN209WP	KN209BP	KN109SP	KN109WP	KN109BP	KN709SP	KN709WP	KN709BP	KN209	KN309	KN809
Down	KN210SP	KN210WP	KN210BP	KN110SP	KN110WP	KN110BP	KN710SP	KN710WP	KN710BP	KN210	KN310	KN810
Up	KN211SP	KN211WP	KN211BP	KN111SP	KN111WP	KN111BP	KN711SP	KN711WP	KN711BP	KN211	KN311	KN811
Fast	KN212SP	KN212WP	KN212BP	KN112SP	KN112WP	KN112BP	KN712SP	KN712WP	KN712BP	KN212	KN312	KN812
Slow	KN213SP	KN213WP	KN213BP	KN113SP	KN113WP	KN113BP	KN713SP	KN713WP	KN713BP	KN213	KN313	KN813
High	KN214SP	KN214WP	KN214BP	KN114SP	KN114WP	KN114BP	KN714SP	KN714WP	KN714BP	KN214	KN314	KN814
Low	KN215SP	KN215WP	KN215BP	KN115SP	KN115WP	KN115BP	KN715SP	KN715WP	KN715BP	KN215	KN315	KN815
Inch	KN216SP	KN216WP	KN216BP	KN116SP	KN116WP	KN116BP	KN716SP	KN716WP	KN716BP	KN216	KN316	KN816
In	KN217SP	KN217WP	KN217BP	KN117SP	KN117WP	KN117BP	KN717SP	KN717WP	KN717BP	KN217	KN317	KN817
Jog	KN218SP	KN218WP	KN218BP	KN118SP	KN118WP	KN118BP	KN718SP	KN718WP	KN718BP	KN218	KN318	KN818
Jog For.	KN219SP	KN219WP	KN219BP	KN119SP	KN119WP	KN119BP	KN719SP	KN719WP	KN719BP	KN219	KN319	KN819
Jog Rev.	KN220SP	KN220WP	KN220BP	KN120SP	KN120WP	KN120BP	KN720SP	KN720WP	KN720BP	KN220	KN320	KN820
Lower	KN221SP	KN221WP	KN221BP	KN121SP	KN121WP	KN121BP	KN721SP	KN721WP	KN721BP	KN221	KN321	KN821
Out	KN222SP	KN222WP	KN222BP	KN122SP	KN122WP	KN122BP	KN722SP	KN722WP	KN722BP	KN222	KN322	KN822
Reset	KN223SP	KN223WP	KN223BP	KN123SP	KN123WP	KN123BP	KN723SP	KN723WP	KN723BP	KN223	KN323	KN823
Run	KN224SP	KN224WP	KN224BP	KN124SP	KN124WP	KN124BP	KN724SP	KN724WP	KN724BP	KN224	KN324	KN824
Start Jog	KN225SP	KN225WP	KN225BP	KN125SP	KN125WP	KN125BP	KN725SP	KN725WP	KN725BP	KN225	KN325	KN825
Test	KN226SP	KN226WP	KN226BP	KN126SP	KN126WP	KN126BP	KN726SP	KN726WP	KN726BP	KN226	KN326	KN826
Raise	KN227SP	KN227WP	KN227BP	KN127SP	KN127WP	KN127BP	KN727SP	KN727WP	KN727BP	KN227	KN327	KN827
Decrease	KN228SP	KN228WP	KN228BP	KN128SP	KN128WP	KN128BP	KN728SP	KN728WP	KN728BP	KN228	KN328	KN828
Increase	KN229SP	KN229WP	KN229BP	KN129SP	KN129WP	KN129BP	KN729SP	KN729WP	KN729BP	KN229	KN329	KN829
Left	KN230SP	KN230WP	KN230BP	KN130SP	KN130WP	KN130BP	KN730SP	KN730WP	KN730BP	KN230	KN330	KN830
Right	KN231SP	KN231WP	KN231BP	KN131SP	KN131WP	KN131BP	KN731SP	KN731WP	KN731BP	KN231	KN331	KN831
Cycle Start	KN232SP	KN232WP	KN232BP	KN132SP	KN132WP	KN132BP	KN732SP	KN732WP	KN732BP	KN232	KN332	KN832
Feed Start	KN233SP	KN233WP	KN233BP	KN133SP	KN133WP	KN133BP	KN733SP	KN733WP	KN733BP	KN233	KN333	KN833
Cycle Stop	KN234SP	KN234WP	KN234BP	KN134SP	KN134WP	KN134BP	KN734SP	KN734WP	KN734BP	KN234	KN334	KN834
Motor Run	KN236SP	KN236WP	KN236BP	KN136SP	KN136WP	KN136BP	KN736SP	KN736WP	KN736BP	KN236	KN336	KN836
Motor Stop	KN237SP	KN237WP	KN237BP	KN137SP	KN137WP	KN137BP	KN737SP	KN737WP	KN737BP	KN237	KN337	KN837
Power On	KN238SP	KN238WP	KN238BP	KN138SP	KN138WP	KN138BP	KN738SP	KN738WP	KN738BP	KN238	KN338	KN838
Pull To Start	N/A	N/A	N/A	KN179SP	KN179WP	KN179BP	KN779SP	KN779WP	KN779BP	N/A	KN379	N/A
Push To Stop												
For Selector Switch or Selector Push Button												
For.-Rev.	KN239SP	KN239WP	KN239BP	KN139SP	KN139WP	KN139BP	KN739SP	KN739WP	KN739BP	KN239	KN339	KN839
Hand-Auto.	KN240SP	KN240WP	KN240BP	KN140SP	KN140WP	KN140BP	KN740SP	KN740WP	KN740BP	KN240	KN340	KN840
High-Low	KN241SP	KN241WP	KN241BP	KN141SP	KN141WP	KN141BP	KN741SP	KN741WP	KN741BP	KN241	KN341	KN841
Jog-Run	KN242SP	KN242WP	KN242BP	KN142SP	KN142WP	KN142BP	KN742SP	KN742WP	KN742BP	KN242	KN342	KN842
Man.-Auto.	KN243SP	KN243WP	KN243BP	KN143SP	KN143WP	KN143BP	KN743SP	KN743WP	KN743BP	KN243	KN343	KN843
Off-On	KN244SP	KN244WP	KN244BP	KN144SP	KN144WP	KN144BP	KN744SP	KN744WP	KN744BP	KN244	KN344	KN844
On-Off	KN245SP	KN245WP	KN245BP	KN145SP	KN145WP	KN145BP	KN745SP	KN745WP	KN745BP	KN245	KN345	KN845
Open-Close	KN246SP	KN246WP	KN246BP	KN146SP	KN146WP	KN146BP	KN746SP	KN746WP	KN746BP	KN246	KN346	KN846
Raise-Lower	KN247SP	KN247WP	KN247BP	KN147SP	KN147WP	KN147BP	KN747SP	KN747WP	KN747BP	KN247	KN347	KN847
Run-Jog	KN248SP	KN248WP	KN248BP	KN148SP	KN148WP	KN148BP	KN748SP	KN748WP	KN748BP	KN248	KN348	KN848
Slow-Fast	KN250SP	KN250WP	KN250BP	KN150SP	KN150WP	KN150BP	KN750SP	KN750WP	KN750BP	KN250	KN350	KN850
Start-Stop	KN251SP	KN251WP	KN251BP	KN151SP	KN151WP	KN151BP	KN751SP	KN751WP	KN751BP	KN251	KN351	KN851
Up-Down	KN253SP	KN253WP	KN253BP	KN153SP	KN153WP	KN153BP	KN753SP	KN753WP	KN753BP	KN253	KN353	KN853
Low-High	KN254SP	KN254WP	KN254BP	KN154SP	KN154WP	KN154BP	KN754SP	KN754WP	KN754BP	KN254	KN354	KN854
Stop-Start	KN255SP	KN255WP	KN255BP	KN155SP	KN155WP	KN155BP	KN755SP	KN755WP	KN755BP	KN255	KN355	KN855
Left-Right	KN256SP	KN256WP	KN256BP	KN156SP	KN156WP	KN156BP	KN756SP	KN756WP	KN756BP	KN256	KN356	KN856
On-Auto	KN276SP	KN276WP	KN276BP	KN176SP	KN176WP	KN176BP	KN776SP	KN776WP	KN776BP	KN276	KN376	KN876
Auto-Off-Hand	KN258SP	KN258WP	KN258BP	KN158SP	KN158WP	KN158BP	KN758SP	KN758WP	KN758BP	KN258	KN358	KN858
For.-Off-Rev.	KN259SP	KN259WP	KN259BP	KN159SP	KN159WP	KN159BP	KN759SP	KN759WP	KN759BP	KN259	KN359	KN859
Hand-Off-Auto.	KN260SP	KN260WP	KN260BP	KN160SP	KN160WP	KN160BP	KN760SP	KN760WP	KN760BP	KN260	KN360	KN860
Man.-Off-Auto.	KN262SP	KN262WP	KN262BP	KN162SP	KN162WP	KN162BP	KN762SP	KN762WP	KN762BP	KN262	KN362	KN862
Open-Off-Close	KN263SP	KN263WP	KN263BP	KN163SP	KN163WP	KN163BP	KN763SP	KN763WP	KN763BP	KN263	KN363	KN863
Up-Off-Down	KN264SP	KN264WP	KN264BP	KN164SP	KN164WP	KN164BP	KN764SP	KN764WP	KN764BP	KN264	KN364	KN864
Low-Off-High	KN265SP	KN265WP	KN265BP	KN165SP	KN165WP	KN165BP	KN765SP	KN765WP	KN765BP	KN265	KN365	KN865
Jog-Stop-Run	KN267SP	KN267WP	KN267BP	KN167SP	KN167WP	KN167BP	KN767SP	KN767WP	KN767BP	KN267	KN367	KN867
High-Low-Off	KN270SP	KN270WP	KN270BP	KN170SP	KN170WP	KN170BP	KN770SP	KN770WP	KN770BP	KN270	KN370	KN870
High-Off-Low	KN277SP	KN277WP	KN277BP	KN177SP	KN177WP	KN177BP	KN777SP	KN777WP	KN777BP	KN277	KN377	KN877
Auto-Man.-Off	KN278SP	KN278WP	KN278BP	KN178SP	KN178WP	KN178BP	KN778SP	KN778WP	KN778BP	KN278	KN378	KN878

(1) Legend plate has red background with silver letters.
 (2) Legend plate has red background with black letters.

Harmony™ 9001K/SK/KX

30 mm push buttons

9001SK – Legend plates

Note: When ordering, add prefix “9001” to the reference.

Legend Plates—Special Marking			
Legend Plate	Description	Reference	
KN100●P (Plastic) (1) 2.25 in Square	Standard Markings	See page 55	
	Special Marking	Silver Field, Black Letters	KN199SP
		White Field, Black Letters	KN199WP
		Red Field, Black Letters	KN199RP
		Black Field, White Letters	KN199BP
KN200 Aluminum	Standard Markings	See page 55	
	Special Marking	Black Field	KN299
Red Field		KN299R	
KN200●P (Plastic) (1) 1.7 in Square	Standard Markings	See page 55	
	Special Marking	Silver Field, Black Letters	KN299SP
		White Field, Black Letters	KN299WP
		Red Field, Black Letters	KN299RP
		Black Field, White Letters	KN299BP
KN300 Aluminum	Standard Markings	See page 55	
	Special Marking	Black Field	KN399
Red Field		KN399R	
KN400 Aluminum	Blank	KN400	
KN500 Aluminum	Any Marking (2)	KN499	
KN500 Aluminum	Standard Markings	See page 55	
	Special Marking	Black Field	KN599
		Green Red Field	KN519
KN600 Aluminum	Blank	Black Field	KN600
		Red Field	KN600R
	Any Marking (2)	Black Field	KN699
		Red Field	KN699R
KN700●P (Plastic) (1) 2.5 in Square	Standard Markings	Select from page 55	
	Special Marking	Silver Field, Black Letters	KN799SP
		White Field, Black Letters	KN799WP
		Red Field, Black Letters	KN799RP
		Black Field, White Letters	KN799BP
KN800 Aluminum	Standard Markings	Select from page 55	
	Special Marking	Blue Field	KN899
Red Field		KN899R	
KN900 Aluminum	Blank	KN900	
Aluminum	Any Marking (2)	KN999	

(1) Other colors available (see table below).
(2) Specify marking required.

Plastic Legend Plates—Other Colors					
	Plate Color	Letter Color	1.7 in Square	2.25 in Square	2.5 in Square
Blank Legend Plates	Yellow	Black	KN200YP	KN100YP	KN700YP
	Green	White	KN200GP	KN100GP	KN700GP
	Blue		KN200LP	KN100LP	KN700LP
	Red		KN200CP	KN100CP	KN700CP
	Orange		KN200AP	KN100AP	KN700AP
	Burnt Orange	Black	KN200HP	KN100HP	KN700HP
Special Engraved Legend Plates	Yellow	Black	KN299YP	KN199YP	KN799YP
	Green	White	KN299GP	KN199GP	KN799GP
	Blue		KN299LP	KN199LP	KN799LP
	Red		KN299CP	KN199CP	KN799CP
	Orange		KN299AP	KN199AP	KN799AP
	Burnt Orange	Black	KN299HP	KN199HP	KN799HP

Maximum Number of Lines and Characters for 9001KN Legend Plates									
Reference	KN100	KN200	KN300	KN400	KN500	KN600	KN700	KN800	KN900
Max. No. of Char. per Line	16	14	18	18	8	22	17	18	18
					per field				per pos.
Max. No. of Lines	2	1	3	2	2	4	2	2	1
					per field				per pos.

Note: The maximum number of characters and lines is a practical maximum, based on a minimum size of characters to facilitate easy reading.

Circular Legends for Emergency Stop Mushroom Heads (yellow background)		
Diameter	Text	Reference
60 mm	—	KN9100
	EMERGENCY STOP	KN9330
90 mm	—	KN8100
	EMERGENCY STOP	KN8330



Legend Plate Position #1

Min. Centerline Spacing, 9001SK Control Units							
Legend Plate	Operator	Centerline Spacing (in)					
		A	B	C	D	E	F
Legend Plate Orientation Position #1							
KN2	Standard Push Button	1.75	1.31	1.44	2.25	1.69	0.88
KN5	1.375 in Dia. Mushroom	1.75	1.31	1.44	2.25	1.69	0.88
	2.25 in Dia. Mushroom	2.25	1.31	1.44	2.25	2.25	1.12
	Selector Switch Knobs	1.75	1.31	1.44	2.25	1.69	0.88
KN3	Standard Push Button	2.00	1.31	1.44	2.25	1.75	0.88
	1.375 in Dia. Mushroom	2.00	1.31	1.44	2.25	1.75	0.88
	2.25 in Dia. Mushroom	2.25	1.31	1.44	2.25	2.25	1.12
	Selector Switch Knobs	2.00	1.31	1.44	2.25	1.75	0.88
KN4	Standard Push Button	1.94	1.31	1.44	2.25	1.62	0.88
	1.375 in Dia. Mushroom	1.94	1.31	1.44	2.25	1.62	0.88
	2.25 in Dia. Mushroom	2.25	1.31	1.44	2.25	2.25	1.12
	Selector Switch Knobs	1.74	1.31	1.44	2.25	1.62	0.88
KN6	Standard Push Button	2.38	1.62	1.44	2.25	2.25	1.12
	1.375 in Dia. Mushroom	2.38	1.62	1.44	2.25	2.25	1.12
	2.25 in Dia. Mushroom	2.38	1.62	1.44	2.25	2.25	1.12
	Selector Switch Knobs	2.38	1.62	1.44	2.25	2.25	1.12



Legend Plate Position #2

Legend Plate Orientation Position #2							
Legend Plate	Operator	A	B	C	D	E	F
KN2	Standard Push Button	1.62	1.31	1.44	2.25	1.75	0.88
KN5	1.375 in Dia. Mushroom	1.62	1.31	1.44	2.25	1.75	0.88
	2.25 in Dia. Mushroom	2.25	1.31	1.44	2.25	2.25	1.12
	Selector Switch Knobs	1.62	1.31	1.44	2.25	1.75	0.88
KN3	Standard Push Button	1.75	1.31	1.44	2.25	2.00	0.88
	1.375 in Dia. Mushroom	1.75	1.31	1.44	2.25	2.00	0.88
	2.25 in Dia. Mushroom	2.25	1.31	1.44	2.25	2.25	1.12
	Selector Switch Knobs	1.75	1.31	1.44	2.25	2.00	0.88
KN4	Standard Push Button	1.62	1.31	1.44	2.25	1.94	1.00
	1.375 in Dia. Mushroom	1.62	1.31	1.44	2.25	1.94	1.00
	2.25 in Dia. Mushroom	2.25	1.31	1.44	2.25	2.25	1.12
	Selector Switch Knobs	1.62	1.31	1.44	2.25	1.94	1.00
KN6	Standard Push Button	2.25	1.31	1.62	2.38	2.38	0.88
	1.375 in Dia. Mushroom	2.25	1.31	1.62	2.38	2.38	0.88
	2.25 in Dia. Mushroom	2.25	1.31	1.62	2.38	2.38	1.12
	Selector Switch Knobs	2.25	1.31	1.62	2.38	2.38	0.88

Special Legend Plates	
Reference	Standard Markings
9001KN500	(For Use with Dual Function Operators: KR6, KR7 and KR67)

Reference	Green	Red
KN500	Blank	Blank
KN501	Start	Stop
KN502	On	Off
Reference	Black	Black
KN520	Blank	Blank
KN521	Start	Stop
KN522	On	Off
KN523	Forward	Reverse
KN524	Up	Down
KN525	High	Low
KN526	Open	Close

Harmony™ 9001K/SK/KX

30 mm push buttons

9001SK – Accessories

Note: When ordering, add prefix “9001” to the reference.

Padlock Attachments			
	Used On	Description	Reference
	Non-illuminated push button — Standard or mushroom (KR4, KR5 mushroom buttons only).	Holds button in depressed position and can be padlocked.	K4
	Non-illuminated push buttons with or without protective boots.	Holds button in depressed position when padlocked.	K5
	Non-illuminated push buttons with or without protective boots.	Holds button in depressed position when padlocked.	K97
	Non-illuminated push buttons, cover type attachment. KR, SKR	Attachment can be padlocked. Does not hold button in depressed position.	K6
	Push buttons, cover type attachment.	Spring loaded cover cannot be padlocked. Does not hold button in depressed position.	K60
	Push-pull operator and illuminated push buttons. KR8, KR9	Holds button in depressed position and can be padlocked.	K62
	KR11U and KR12U Interlocked Assembly	Holds maintained button in depressed position and can be padlocked.	K96
	9001SKR9 Push-pull operators— Non-Illuminated and Illuminated	Holds button in depressed position. Can be padlocked.	K162

Mushroom Button Guards



Reference	Reference	Used On
K48	K56▲ (1)	SKR4
	K56■M (2)	SKR8, SKR9

(1) Replace ▲ with B=Black, G=Green, R=Red or Y=Yellow.
 (2) Replace ■ with R=Red or Y=Yellow. The mushroom guard has finger holes for push-pull operators.

Padlock Attachments			
	Used On	Description	Reference
	Selector switches and potentiometers (will not work with gloved-hand knob).	Cover type attachment that can be padlocked to keep unauthorized personnel from tampering with the operator.	K7
	Selector switches and potentiometers (will not work with gloved-hand knob).	Same as 9001K7 but with spring loaded lockout cover.	K107
	Illuminated push buttons (with or without guard) and key operated push buttons.	Cover type attachment that can be padlocked to keep unauthorized personnel from tampering with the operator.	K108
	Illuminated push buttons (with or without guard) and key operated push buttons.	Same as 9001K108 but with spring loaded lockout cover.	K109
	Maintained push-pull operators using 1.375 in dia. mushroom buttons (-20 series as shown on page 58).	Cover type attachment that holds mushroom button in depressed position and can be padlocked.	K110

Protective Boots



These 9001KU protective boots are recommended for very dirty environments or severe hose down, but they are not required for UL Type 4 or 4X rating on the 9001SK operators. The 9001K1 wrench (see page 59) is required for installation of these boots.

For Non-Illuminated Push Buttons (3)		Clear Color for	Reference
Color	Reference	Standard knob selector switch	KU17
Black	KU1	Gloved-hand cap for use on standard knob selector switch	KU18
Red	KU2		
Blue	KU3		
Brown	KU4	Standard pilot light and maintained contact push buttons	KU27
Green	KU5		
Yellow	KU6		
Clear	KU7	Push-to-test and illuminated push button without guard	KU37
Clear	KU8	Illuminated push button with guard	KU47

(Provides Full Guard)

(3) Use KU27 for maintained contact push buttons.

Closing Plates

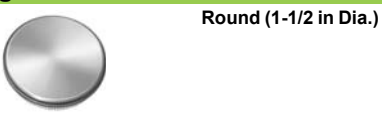

Description	Reference
Gray	K51 (4)
Black	K52 (4)

(4) Meets UL and NEMA 1, 2, 3, 4, 4X, 6, 12 and 13.

Harmony™ 9001K/SK/KX

30 mm push buttons

9001SK – Accessories

Note: When ordering, add prefix “9001” to the reference.

Accessories								
Description	Color	Reference	Package Qty.	Description	Color	Reference	Package Qty.	
 <p>Color inserts for KR1, KR2, KR3, KR11, KR12, KR24, T, TRD</p>	Black	T8BK	10	 <p>1-3/8 in Mushroom Knob for Illuminated Push Buttons K2L (9)</p>	Amber	A20	1	
	Blue	T8BE			Blue	L20		
	Gray	T8GY			Clear	C20		
	Green	T8GN			Green	G20		
	Orange	T8OE			Red	R20		
	Red	T8RD			White	W20		
	Universal (1)	T8U	7		Yellow	Y20		
	White	T8WH	10	 <p>2-1/4 in Mushroom Knob for Illuminated Push Buttons K2L (9)</p>	Amber	A21	1	
	Yellow	T8YW			Blue	L21		
	Black	K16B	1		Clear	C21		
	Blue	K16L			Green	G21		
	Green	K16G		Red	R21			
	Orange	K16S		White	W21			
	Red	K16R		Yellow	Y21			
	Red (2)	K16R05		 <p>Plastic Fresnel Pilot Light Lens for KP, KT</p>	Amber	A31	1	
	Yellow	K16Y			Blue	L31		
	Black	K17B	1		Clear	C31		
	Blue	K17L			Green	G31		
	Green	K17G		Red	R31			
	Orange	K17S		White	W31			
	Red	K17R		Yellow	Y31			
	Red (2)	K17R05		 <p>Domed Plastic Pilot Light Lens for KP, KT</p>	Amber	A9	1	
	Yellow	K17Y			Blue	L9		
	Black	K92B	1		Clear	C9		
	Blue	K92L			Green	G9		
	Green	K92G		Red	R9			
	Orange	K92S		White	W9			
	Red	K92R		Yellow	Y9			
	Yellow	K92Y		 <p>Glass Pilot Light Lens for KP, KT</p>	Amber	A6	1	
	Black	K93B	1		Blue	L6		
	Blue	K93L			Clear	C6		
	Green	K93G			Green	G6		
	Orange	K93S		Red	R6			
	Red	K93R		White	W6			
	Yellow	K93Y		Yellow	Y6			
	Amber	A22	1	 <p>Standard Selector Switch Knob for 9001K Selector Switches</p>	Amber	A8	1	
	Black (7)	B23			Black (7)	B11		
	Blue	L22			Blue	L8		
	Clear	C22			Clear	C8		
	Green	G22		Green	G8			
	Orange (7)	S23		Orange (7)	S11			
	Red	R22		Red	R8			
	Red (10)	R2205		White	W8			
	White	W22		Yellow	Y8			
	Yellow	Y22		 <p>Gloved-Hand Selector Switch Knob for 9001K Selector Switches</p>	Amber	A24	1	
	Black	B19	10		Black (7)	B25		
	Green	G19			Blue	L24		
	Red	R19			Clear	C24		
	Universal (8)	U19		Green	G24			
	Amber	A7	1	Orange (7)	S25			
	Blue	L7		Red	R24			
	Clear	C7		White	W24			
	Green	G7		Yellow	Y24			
	Red	R7		 <p>Color Inserts for KQ and TQ Selector Push Buttons</p>	Black	T5BK	10	
	White	W7			Blue	T5BE		
	Yellow	Y7			Green	T5GN		
	Red	R94	1		Orange	T5OE		
	Red	K92RM	1	Red	T5RD			
	Green	K92GM		White	T5WH			
	Black	K92BM		Yellow	T5YW			
	Red	K93RM	1	 <p>Selector Switch Cams</p>	Description		Cam	Reference
	Green	K93GM			B	K13B		
	Black	K93BM		C	K13C			
	Red	K94RM	1	D	K13D			
	Green	K94GM		E	K13E			
	Black	K94BM		F	K13F			
	Red	K95RM	1	G	K13G			
	Green	K95GM		H	K13H			
	Black	K95BM		J	K13J			
	Red	K95RM	1	L	K13L			
	Green	K95GM		M	K13M			
	Black	K95BM						

(1) Includes one each of the following color inserts: Black, Red, Green, Yellow, Orange, Blue, and White.
 (2) “EMERGENCY STOP” is in raised letters and hot stamped white across the front of the mushroom button.
 (3) The mushroom button cap listed here may be assembled to a 9001KR1U to form a 9001KR4.
 (4) The mushroom button cap listed here may be assembled to a 9001KR1U to form a 9001KR5.
 (5) The mushroom button cap listed here may be assembled to a 9001KR20 to form a 9001KR24.
 (6) The mushroom button cap listed here may be assembled to a 9001KR20 to form a 9001KR25.
 (7) These color caps are opaque and are for use on non-illuminated operators only.
 (8) Includes two of each of the following color inserts: Black, Red, and Green.
 (9) May be used on KR8 and KR9 operators. Order mushroom button and K54 adapter (no charge) from page 59. Using the K54 adapter voids Type 6 rating.
 (10) Red knob with “Push Emergency Stop” marked on top of knob.

Harmony™ 9001K/SK/KX

30 mm push buttons

9001SK – Replacement parts

Ring Nuts	
Used On	Reference
SK1L	9001SK44
—	—
—	—
SK20, SK21, SK22, SK23	9001SK45
SK20, SK21, SK22, SK23 (3)	9001SK46
SK2L	9001SK49
—	—
—	—
SKP, SKTR	9001SK41
SKR1	9001SK41
SKR11	9001SK42
SKR12 (1)	9001SK42
SKR12 (2)	9001SK41
—	—
SKR2	9001SK42
—	—
—	—
SKR25	9001SK49
SKR3	9001SK40
SKR4	9001SK41
SKR5	9001SK41
—	—
—	—
—	—
SKR8	6509704401
SKR9	9001SK41
SKS	9001SK45
SKS (3)	9001SK46
SKRU11	9001SK41
SKRU1,2,3,4,5,10	9001SK40
SKT	9001SK49

(1) Maintained button of two button operator.

(2) Momentary button of two button operator.

(3) Secondary ring nut (holds knob on selector switch or potentiometer).

Replacement Lamps For Series A–F (black) Light Modules

Light Module Reference	Lamp Number (ANSI)	Schneider Electric Replacement Lamp Reference
KM1	GE44 (4)	—
KM2	GE1490	2550101003
KM3	GE44 (4)	—
KM4	GE1490	2550101003
KM5	GE44 (4)	—
KM6	GE44 (4)	—
KM7	GE44 (4)	—
KM8	GE44 (4)	—
KM9	GE755	2550101020
KM11	CMDK1A5	2550105014
KM12	CMDK1A5	2550105014
KM13	CMDK1A5	2550105014
KM14	CMDK1A5	2550105014
KM15	CMDK1A5	2550105014
KM21	SYL12PSB	2550105003
KM22	SYL12PSB	2550105003
KM23	SYL28PSB	2550105008
KM25	SYL120PSB	2550105005
KM31	SYL6PSB	2550105007
KM32	SYL12PSB	2550105003
KM34	SYL24PSB	2550105004
KM35	SYL28PSB	2550105008
KM36	SYL48PSB	2550105009
KM37	SYL60PSB	2550105010
KM38	SYL120PSB	2550105005

(4) GE44 and GE755 are interchangeable (GE755 gives longer life). If a GE44 lamp is ordered, a GE755 (2550101020) will be substituted. For a replacement lamp in a current series light module see the light module listing on page 54.

Product range:
page 36

Specifications:
page 38

Dimensions:
page 60

Mounting:
page 61

Repair Parts	
Description	Reference
E10 Key	2941101100
Gray cap for 9001SKR11, or 9001SKR12	3105217001
Clear plastic top (only) for 9001SK44 Ring Nut	4487D63XI
Gasket for 9001K and 9001SK Push-pull Knob	6509701801
Gasket for Plastic Illuminated Lens	6509701901
Gasket for 9001SK selector switch knob	3105406401
Black Compensating Gasket	6509702001
Liner for Non-Illuminated Operators	6509704901
Locking Thrust Washer	6512231201
Nylon Spacer	6509705001
Locking Thrust Washer (Std. 9001SK Operator)	6512240601
Push-pull Mushroom Adapter (5)	9001K54
Rubber Boot for Joystick	6512243201
Knob on Joysticks without latch	4458D20X3
Knob for SK Potentiometer	3105404408
Fingersafe Cover for 9001KM	6508804101

(5) Allows Type -20 and -21 mushroom color caps to be used on push-pull operators. Use of 9001K54 voids Type 6 rating.

KU Replacement Ring Nuts (Threaded Inside and Out)	
Used On	Reference
KU1 through KU8, KU27, KU37, KU47	3105204101
KU17, KU18	3105205901

Interlock	
	<p>For mechanically interlocking two push buttons so that only one button can be depressed at a time. A K3 attachment is furnished with the 9001SKR11, SKR12, SKRU1 and SKRU11 operators. However, these are maintained operators and the K3 interlock serves to release one of the buttons when the other is depressed. When used with momentary contact buttons, the K3 interlock does not hold the buttons in the depressed position. It simply prevents pushing both buttons at the same time.</p> <p>The K3 interlock is mounted behind the operators. Operators not included.</p>

Reference

9001K3

Screwdriver	
Reference	
	
9001K69	Used to tighten mounting screws on contact blocks and light modules.

Wrenches	
K95	
K1	

Where Used	Reference
For tightening ring nuts on 22 and 30 mm control units	9001K95
For protective cap kits	9001K1

Harmony™ 9001K/SK/KX

30 mm push buttons

9001SK

Dimensions

Push buttons



e: panel thickness 1 to 6 mm

Full guard
9001SKR1●●●



No guard
9001SKR3●●●



No guard with extended guard
9001SKR2●●●



Mushroom head push buttons

Spring return 35 mm:
9001SKR24●H13,
9001SKR4RH6,
9001SKR9R20H6

Spring return 57 mm:
9001SKR25●H13,
9001SKR5RH6

Push-pull 35 mm:
9001SKR9R20H6
Push-pull 41 mm:
9001SKR9●H13,
9001SKR9RH6
9001SKR8●H25
Push-pull 57 mm:
9001SKR9R21H6

Spring return 35, 57 and 60 mm a = 28 mm

Push-pull 35 to 60 mm a = 32 mm



e: panel thickness 1 to 6 mm



Turn-to-release 9001SKR16H13, 9001SKR16H2 and 9001SKR16



e: panel thickness 1 to 6 mm



Selector switches



e: panel thickness 1 to 6 mm

Gloved handle 9001SKS●●FBH●●



Dual Dimensions: in (mm)

Mounting

Contact block mounting position



1 It is possible to mount up to 3 levels of contacts blocks (maximum of 6 contacts blocks) on 9001SK references. For Maximum Contact Block usage, see Page 50.

Panel cut-out



Individual cut-outs detail

2 alternatives



Type of 9001K unit	Legend plate	a: in (mm)	b: in (mm)
All units except 57 mm mushroom head push buttons	9001KN2●●	2.25 (57.2)	1.75 (44.5)
	9001KN3●●	2.25 (57.2)	2.00 (50.8)
57 mm mushroom head push buttons	9001KN2●●	2.25 (57.2)	2.25 (57.2)
	9001KN3●●	2.25 (57.2)	2.25 (57.2)

Harmony™ 9001K/SK/KX

30 mm push buttons

9001SK

Dimensions (continued)

Pilot lights

With BA 9s bulb 9001SKP●●●



e: panel thickness 1 to 6 mm

Illuminated mushroom head push buttons

9001SKR●P●●●



e: panel thickness 1 to 6 mm

Illuminated push buttons, spring return

Full guard 9001SK3L●●●●H13



e: panel thickness 1 to 6 mm

Heads for spring return push buttons

9001SKR●U



No guard 9001SK2L●●●●H13



e: panel thickness 1 to 6 mm

Boots for push buttons

9001KU●



Push-to-test, no guard 9001SKT●●●●31



e: panel thickness 1 to 6 mm

Dual Dimensions: in (mm)

Dimensions (continued)

Rod for wobble stick

9001K8



Interlocked push buttons

9001SKR11, 9001SKR12

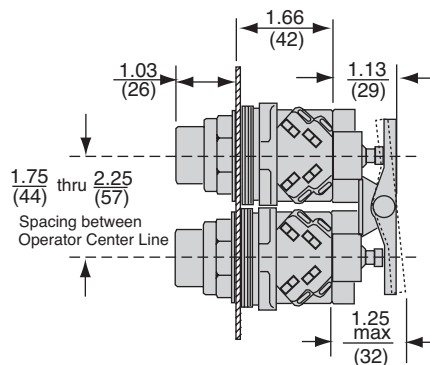

Light blocks for pilot lights and illuminated push buttons

9001KM●



e: panel thickness 1 to 6 mm

Contact blocks for push buttons (including illuminated)

9001KA●



e: panel thickness 1 to 6 mm

It is not possible to mount complementary contact blocks 9001KA4 to KA6.

Legend plates

Aluminium plates 9001KN1●●, 9001KN2●●, 9001KN7●●

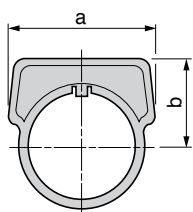

Legend plate	a: in (mm)	b: in (mm)
9001KN2●●	1.625 (41)	0.969 (24)
9001KN3●●	1.750 (45)	1.234 (31)

Plastic plates 9001KN1●●P, 9001KN2●●P, 9001KN7●●P



Legend plate	a: in (mm)	b: in (mm)
9001KN1●●P	2.25 (57)	2.25 (57)
9001KN2●●P	1.75 (45)	1.75 (45)
9001KN7●●P	2.50 (63)	2.50 (63)

Potentiometer

9001SK20 (1), 9001SK21 (2)



(1) Without potentiometer
(2) With potentiometer

9001SK22 (1), 9001SK23 (2)



(1) Without potentiometer
(2) With potentiometer

Dual Dimensions: in (mm)

Harmony™ 9001K/SK/KX

30 mm push buttons

9001SK

Dimensions (continued)

Time delay push button

9001KRD

Alternate action—Push-on, push-off module

9001K85



	a	b
9001KRD1UH●	Full guard 9/16	2-1/2
9001KRD2UH●	Extended guard 11/16	2-1/2
9001KRD3UH●	No guard 9/16	2-1/2

Emergency break glass operator

9001K15

Rocker arm operating lever

9001K50



Dual Dimensions: in (mm)

Harmony™ 9001K/SK/KX

30 mm push buttons

9001SK

Dimensions (continued)

Padlock attachments

9001K4



9001K96



9001K7, 9001K107, 9001K108, 9001K109, 9001K113



9001K6, 9001K60, 9001K97



9001K62



9001K5



Mushroom button guards

9001K48



9001K56Y, 9001K56YM (1)



9001K68



(1) 9001K56YM includes finger holes.

Dual Dimensions: in (mm)

Complete units

Non-illuminated push buttons



Non-illuminated single push button with contacts
9001KXRA133 See page 70



Non-illuminated dual push button with contacts
9001KXRC136 See page 70

Illuminated push buttons



Illuminated single push button with contacts
9001KXRB1RH1 See page 70



Dual push button with 1 pilot light and contacts
9001KXRG137 See page 70



Dual push button with 2 pilot light and contacts
9001KXRL138 See page 70

Selector switches



Selector switch
9001KXSA139 See page 71

Pilot lights



Pilot light
9001KXPA1R See page 71

Harmony™ 9001K/SK/KX

30 mm push buttons

9001KX

Environmental specifications		
Conforming to standards	 	UL 508, CSA C22-2 n° 14, CE marked, RoHS compliant
Product certifications	 File E78403 CCN NKCR  File LR25490C Class 3211 03	UL File E78403, CSA File LR25490C, Guide 184N13-1U
Protective treatment standard version		"TC"
Ambient air temperature around the device	Storage	°F (°C) -40 to +158 (-40 to +70)
	Operation	°F (°C) -22 to +140 at 50% relative humidity (-30 to +60)
Degree of protection	Conforming to EN/IEC 60529	IP 66
	Conforming to NEMA	Types 1, 2, 3, 3R, 4, 12 and 13
Mechanical life (in millions of operating cycles)	Push buttons, spring return	5
	Illuminated push buttons	5
	Selector switches and key switches	0.5
Mounting position		All positions

Electrical characteristics of contact blocks						
Rated operational characteristics	~ AC-15	3 A, 240 V				
	≡ DC-13	0.55 A, 125 V				
Rated insulation voltage	Conforming to EN/IEC 60947-1	V U _i = 250 degree of pollution 3 (except pilot lights with incandescent bulb: degree of pollution 2)				
Rated impulse withstand voltage	Conforming to EN/IEC 60947-1	kV U _{imp} = 2.5				
Contact material	Normal environment and usage	Silver alloy				
Contact operation	"N/C" ou "N/O"	Slow break				
Positive operation	Conforming to EN/IEC 60947-5-1	N N/C contact(s) with positive opening operation				
Short-circuit protection	Conforming to EN/IEC 60947-5-1	A Cartridge fuse mounted upstream: 10				
Cabling capacity (9001KA contact blocks and 9001KM light modules)	Conforming to EN/IEC 60947-1	mm ² mm ² Screw clamp terminals (cross headed/slotted screw) Mini: 1 x 0.22 Maxi: 2 x 1.5 Recommended tightening torque: 0.8 N.m (10 in-lbs)				
Thermal current	I _{th}	A 10				
Maximum operation current	a.c. supply: utilization category AC-15 NEMA A600	Contact making capacity				
		V	120	240	480	600
		A	60	30	15	12
	VA	7200	7200	7200	7200	
	d.c. supply: utilization category DC-13 NEMA Q600	Breaking capacity				
		V	120	240	480	600
A		6	3	1.5	1.2	
VA	720	720	720	720		
		Contact making capacity and breaking capacity				
V	125	250	600			
A	0.55	0.27	0.1			

Basic Operators

Description	UL Types/NEMA Types
Single Push Buttons	4, 4X, 13
Dual Push Buttons	9001KXRA, 9001KXRB
Dual Push Buttons with One Pilot Light	9001KXRC, 9001KXRD, 9001KXRE
Dual Push Buttons with Two Pilot Light	9001KXRG, 9001KXRJ
Selector Switches	9001KXRL
Potentiometers	9001KXS
	9001KXB

Non Hazardous Locations:



File E42259
CCN NKCR



File LR25490
Class 3211 03



Marking

The KX operators are rated UL Types 1, 2, 3, 3R, 4, 4X, 6, 12, 13/ NEMA Types 1, 2, 3, 3R, 4X, 6, 12, 13 without the use of protective boots. Boots are recommended for dirty environments or areas that are hosed down with water under very high pressure.

Mounting

Panel cut-out



Individual cut-outs detail

2 alternatives



Preferred Cut-Out

Alternate Cut-Out

Use Greenlee Tool #60242 for punching hole and notch.

9001KX Operator Materials

Single Push Button (KXRA, KXRB, KXRN, KXRP, KXTA)

Gasket – Nitrile
 Locking Head – ZAMAC #3
 Screws – Steel
 Terminals – Steel
 Button – Polycarbonate
 Seal – Nitrile
 Seal Retainer – Steel
 Bezel – Zinc
 Stem – Polycarbonate
 Stem Cover – Polycarbonate
 Legend Insert – Polyester
 Return-Spring – Music Wire
 Ring Nut – Zinc or Aluminum
 Adaptor – Zinc
 Adaptor Mounting Clip – Music Wire
 Liner – Nylon

Dual Push Button (Non-Illuminated and Illuminated) (KXRC, KXRD, KXRE, KXRF, KXRG, KXRH, KXRJ, KXRK, KXRL, KXRM, KXTC)

Gasket – Nitrile
 Seal – Nitrile
 Seal Retainer – Brass
 Bezel – Zinc
 Button Stem – Stainless Steel
 Button – Polycarbonate
 Button Cover – Polycarbonate
 Legend Insert – Polyester
 Lamp Cover – Polycarbonate
 Lens Retainer – Polycarbonate
 Lens – Polycarbonate
 Return-Spring – Music Wire
 Ring Nut – Zinc or Aluminum
 Adaptor – Zinc
 Adaptor Mounting Clip – Music Wire
 Liner – Nylon
 Retainer Ring – Steel
 Interlock Pad – Polyester
 Interlock – Sintered Steel
 Interlock – Nylon (KXRD)
 Pin – Steel (KXRE, KXRF)
 Detent Bearing – Steel (KXRE, KXRF)
 Detent Spring – Music Wire (KXRE, KXRF)
 Interlock – Steel (KXRM)
 Baffle – Steel
 Locking Head – ZAMAC #3
 Screws – Steel
 Stem – Polycarbonate
 Stem Cover – Polycarbonate
 Terminals – Steel

Selector Switch (Non-Illuminated and Illuminated) (KXS)

Gasket – Nitrile
 Seal – Nitrile
 Seal Retainer – Steel
 Return Spring – Music Wire
 Cam Rotor – Celenex 3300
 Cam Follower – Delrin 100
 Cam Carrier – Trogamid
 Cam Profile – Delrin 100
 Bearing – Polyester
 Bezel – Zinc
 Knob – Polycarbonate or Nylon
 Knob Ring Nut – Polycarbonate
 Knob Seal – Nitrile
 Legend Plate – ABS
 Plug Insert – Polyester
 Key Plug – Zinc, Brass, Music Wire
 Key – Brass
 Locking Head – Zinc
 Locking Head Seal – Nitrile
 Insert – Zinc
 Adaptor – Zinc
 Adaptor Mounting Clip – Music Wire
 Liner – Nylon
 Ring Nut – Zinc or Aluminum
 Terminals – Steel
 Screws – Steel

Contact Block (9001KA)

Housing – Amorphous Nylon
 Contact Slider – Nylon or Acetal
 Terminal – Steel
 Saddle Clamp – Steel
 Spring – Steel
 Contacts – Silver and Copper
 Blade – Beryllium Copper
 Label – Paper
 Shrouds – Delrin 507
 Lockout – 410 Stainless Steel
 Closing Plate – ZAMAC #3
 Boots – Neoprene

Potentiometer (KXBA, KXBB, KXBC, KXBD):

Pot – Clarostat Types J and EJ
 Operator – ZAMAC #3
 Legend Plate – ABS
 Knob – Polycarbonate
 Printed circuit board – Phenolic
 Cam Rotor – Polyester
 Cam – Acetal
 Cam Carrier – Nylon
 Adaptor – ZAMAC #3
 Adaptor Spring – Square Music Wire
 Spacer – Fiber Board
 Gasket – Buna N
 Terminal – Brass
 Screws – Steel
 Bezel – Zinc
 Locking Head – ZAMAC #3
 Legend Inserts (KXN100, KXN200, KXN300, KXN400, KXN500)
 – 0.005 Thk. Matte Polyester
 Legend Plates (KXN-600, KXN-700) – ABS

Pilot Light (KXPA, KXPB, KXPC, KXTE)

O-Ring – Nitrile
 Bezel – Zinc
 Button – Polycarbonate
 Button Cover – Polycarbonate
 Button Stem – Polycarbonate
 Screws – Steel
 Terminals – Steel
 Lens Assembly – Polycarbonate
 Baffle – Steel
 Ring Nut – Zinc or Aluminum
 Adaptor – Zinc
 Adaptor Mounting Clip – Music Wire

Light Module (Single Lamp KM)

Housing – Thermoplastic Polyester
 Socket – Steel
 Terminal – Steel with Tin Plate
 Saddle Clamp – Steel
 Translating Pin – Polycarbonate
 Transformer – Thermoplastic Polyester, Steel, Copper,
 Polyvinyl Chloride, Polytetrafluoroethylene, Acetate, Paper
 Lamp Spring – Tin Plated Music Wire

Light Module (2 Lamp KXAKM2)

Adaptor Screw – Steel
 Housing – Thermoplastic Polyester
 Lamp Terminal – Copper
 Terminal – Steel
 Saddle Clamp – Steel
 Contact Spring – Copper
 Translating Pin – Polycarbonate
 Transformer – Thermoplastic Polyester, Steel, Copper, Polyvinyl
 Chloride, Polytetrafluoroethylene, Acetate, Paper

Light Module (4 Lamp KXAKM4)

Housing – Thermoplastic Polyester
 Lamp Terminal – Copper
 Adaptor Screw – Steel
 Terminal – Steel
 Saddle Clamp – Steel
 Transformer – Nylon, Steel, Copper, Polyvinyl Chloride,
 Polytetrafluoroethylene, Acetate, Paper

Harmony™ 9001K/SK/KX

30 mm push buttons

9001KX – Push buttons with contacts

Note: When ordering, add prefix “9001” to the reference.



Push Buttons—Single, with Contacts						
Description	Button Color	Legend Marking	Contacts	Voltage	Reference	
Non-Illuminated	Green	Start	1 N/O	—	KXRA133	
	Red	Stop	1 N/C	—	KXRA134	
	Amber	blank	2 N/O + 2 N/C	—	KXRAAH2	
	Green	blank	2 N/O + 2 N/C	—	KXRAGH2	
Illuminated	Blue	blank	2 N/O + 2 N/C	—	KXRALH2	
	Amber	blank	1 N/O + 1 N/C	24	KXRB34AH1	
	Green	blank	1 N/O + 1 N/C	24	KXRB34GH1	
	Red	blank	1 N/O + 1 N/C	24	KXRB34RH1	
	Amber	blank	1 N/O + 1 N/C	110/120	KXRB1AH1	
	Green	blank	1 N/O + 1 N/C	110/120	KXRB1GH1	
	Red	blank	1 N/O + 1 N/C	110/120	KXRB1RH1	



Push Buttons—Dual, with Contacts				
Description	Top Button (#1)	Lower Button (#2)	Contacts	Reference
Momentary	Start (Green)	Stop (Red)	2 N/O + 2 N/C	KXRC111
Momentary	Start (Green)	Stop (Red)	1 N/O, 1 N/C	KXRC136
Momentary	Up (Green)	Down (Green)	2 N/O	KXRD140
Momentary	blank (Blue)	blank (Blue)	2 N/O	KXRDLLH7
Maintained (1)	Start (Green)	Stop (Red)	1 N/O + 1 N/C	KXRE115
Maintained (1)	On (Blue) (2)	Off (Blue) (2)	3 C/O	KXRELLH3
Maintained (1)	On (Blue) (2)	Off (Blue) (2)	3 C/O	KXRELLH3
Maintained (1)	On (Blue) (2)	Off (Blue) (2)	2 N/O + 2 N/C	KXRELLH2



Pilot Light at 110–120 V, 50–60 Hz Transformer

Push Buttons—Dual with One Pilot Light and Contacts						
Description	Top Button (#1)	Middle Lens (#2)	Lower Button (#3)	Contacts	Voltage	Reference
Momentary	Start (Green)	On (Red)	Stop (Red)	2 N/O + 2 N/C	110/120	KXRG117
Momentary	Start (Green)	On (Red)	Stop (Red)	1 N/O, 1 N/C	110/120	KXRG137
Maintained (1)	Start (Green)	On (Red)	Stop (Red)	1 N/O + 1 N/C	110/120	KXRJ119



Pilot Lights at 110–120 V, 50–60 Hz Transformer

Push Buttons—Dual with Two Pilot Lights and Contacts							
Description	Top Button (#1)	Left Lens (#2)	Right Lens (#3)	Lower Button (#4)	Contacts	Voltage	Reference
Momentary	Start (Green)	On (Red)	Off (Green)	Stop (Red)	2 N/O + 2 N/C	110/120	KXRL121
Momentary	Start (Green)	On (Red)	Off (Green)	Stop (Red)	1 N/O, 1 N/C	110/120	KXRL138
Momentary	Start (Green)	On (Red)	Off (Green)	Stop (Red)	2 N/O + 2 N/C	24	KXRL34GRGRH2
Momentary	Start (Green)	On (Red)	Off (Green)	Stop (Red)	1 N/O, 1 N/C	24	KXRL34GRGRH37

(1) Maintained operators are mechanically interlocked.
 (2) Text is vertical.

Harmony™ 9001K/SK/KX

30 mm push buttons

9001KX – Push buttons without contacts

Note: When ordering, add prefix “9001” to the reference.



Push Buttons—without Contacts (1)

Push Button	Action	Lens Color (1)	Lens Color (2)	Reference
Single Push Button				
Non-Illuminated	Momentary	Amber	—	KXRAA
		Green	—	KXRAG
		Blue	—	KXRAL
		Red	—	KXRAR
		White	—	KXRAW
Illuminated 24 V	Momentary	Amber	—	KXRB35A
		Green	—	KXRB35G
		Blue	—	KXRB35L
		Red	—	KXRB35R
		White	—	KXRB35W
Illuminated 110/120 V	Momentary	Amber	—	KXRB38A
		Green	—	KXRB38G
		Blue	—	KXRB38L
		Red	—	KXRB38R
		White	—	KXRB38W
Dual Push Button				
Non-Illuminated	Momentary + Interlock	Green	Red	KXRCGR
		White	White	KXRCWW
		Green	Green	KXRCGG
	Maintained + Interlock	Green	Red	KXREGR
		White	White	KXREWW
		Green	Green	KXREGG



Dual Push Button with Pilot Light—without Contacts (1)

Action	Voltage	Lens Color (1)	Lens Color (2)	Lens Color (3)	Lens Color (4)	Reference	
With One Pilot Light							
Momentary	24 Vac/dc	Red	White	Green	—	KXRG35RWG	
	24 Vac/dc	Green	White	Green	—	KXRG35GWG	
	110/120 Vac/dc	Red	White	Green	—	KXRG38RWG	
	110/120 Vac/dc	Green	White	Green	—	KXRG38GWG	
Momentary + Interlock	24 Vac/dc	Red	White	Green	—	KXRH35RWG	
	24 Vac/dc	Green	White	Green	—	KXRH354GWG	
	110/120 Vac/dc	Red	White	Green	—	KXRH38RWG	
110/120 Vac/dc	Green	White	Green	—	KXRH38GWG		
	Maintained + Interlock	24 Vac/dc	Red	White	Green	—	KXRJ35RWG
		24 Vac/dc	Green	White	Green	—	KXRJ35GWG
110/120 Vac/dc		Red	White	Green	—	KXRJ38RWG	
110/120 Vac/dc		Green	White	Green	—	KXRJ38GWG	
With Two Pilot Lights							
Momentary	24 Vac/dc	Red	White	White	Green	KXRL35RWWG	
	24 Vac/dc	Red	Red	Green	Green	KXRL35GGRR	
	110/120 Vac/dc	Red	White	White	Green	KXRL38RWWG	
	110/120 Vac/dc	Red	Red	Green	Green	KXRL38GGRR	
Momentary + Interlock	24 Vac/dc	Red	White	White	Green	KXRM35RWWG	
	24 Vac/dc	Red	Red	Green	Green	KXRM35RRGG	
	110/120 Vac/dc	Red	White	White	Green	KXRM38RWWG	
110/120 Vac/dc	Red	Red	Green	Green	KXRM38RRGG		



(1) Order contacts separately (see page 73). For accessories, see page 74.

Harmony™ 9001K/SK/KX

30 mm push buttons

9001KX – Selector switches, contact blocks

Note: When ordering, add prefix “9001” to the reference.



Selector Switches—with Contacts

Description	Legend	Knob	Contacts	Reference
2-Position, maintained	Off-On	Black	1 0	KXSA125
			0 1	
2-Position, maintained	Off-On	Black	1 0	KXSA139
3-Position, maintained	Hand-Off-Auto	Black	1 0 0	KXSD126
			0 0 1	

Selector Switches—without Contacts (1)

Description		Voltage	Knob Color	Reference
2-Position, Maintained	Non-Illuminated	—	Black	KXSAEB
	Illuminated	24 Vac/dc	Red	KXSJE35R
	Illuminated	24 Vac/dc	Green	KXSJE35G
	Illuminated	24 Vac/dc	White	KXSJE35W
	Illuminated	120 Vac/dc	Red	KXSJE38R
	Illuminated	120 Vac/dc	Green	KXSJE38G
	Illuminated	120 Vac/dc	White	KXSJE38W
	Key (Withdraw L)	—	N/A	KXSRE1
	Key (Withdraw R)	—	N/A	KXSRE2
3-Position, Maintained	Key (Withdraw Both)	—	N/A	KXSRE3
	Non-Illuminated	—	Black	KXSDCB
	Key (Withdraw C)	—	N/A	KXSVC5
4-Position, Maintained	Key (Withdraw All)	—	N/A	KXSVC10
	Non-Illuminated	—	Black	KXSHHB

(1) Order contacts separately (see table below).

Contact Blocks—Purchase Separately

Description			Reference	Description			Reference
	Clear Cover	1 N/O, 1 N/C	KA1		Clear Cover	1 N/C, 1 N/O (Early Make)	KA4
	Green Cover	1 N/O	KA2		Red Cover	1 N/C (Late Break)	KA5
	Red Cover	1 N/C	KA3		Green Cover	1 N/O (Early Make)	KA6

Maximum Contact Block Usage:

- 2 blocks mounted side by side only:** Any 2 or 3-Position spring return selector switch (non-illuminated, illuminated or keyed).
- 2 blocks mounted in tandem on one side only:** Any 2 operator interlocked push button.
- 2 blocks mounted in tandem (total of four blocks):** Any selector push button, keyed push button, 2 or 3-Position maintained selector switch (non-illuminated, illuminated or keyed), push pull operators (non-illuminated or illuminated), joy stick, dual push button.
- 3 blocks mounted in tandem (total of six blocks):** Single momentary push buttons (non-illuminated or illuminated).



Potentiometers

Description	Power	Resistance	Reference
Single	2 W	3.2 kΩ	KXBB06
Single	2 W	5 kΩ	KXBB07
Single	2 W	10 kΩ	KXBB08
Tandem	2 W	5 kΩ / 5 kΩ	KXBD83

Harmony™ 9001K/SK/KX

30 mm push buttons

9001KX – Pilot lights

Note: When ordering, add prefix “9001” to the reference.



110–120 V,
50–60 Hz
Transformer



1
2
110–120 V, 50–60 Hz.
Transformer



110–120 V, 50–60 Hz
Transformer

Pilot Lights

Description	Voltage	Lens 1*	Lens 2*	Lens 3*	Lens 4*	Reference
Single	24	Amber				KXPA35A
Single	24	Red				KXPA35R
Single	24	Green				KXPA35G
Single	24	White				KXPA35W
Single	110/120	Amber				KXPA1A
Single	110/120	Red				KXPA1R
Single	110/120	Green				KXPA1G
Single	110/120	White				KXPA1W
Dual	24	Amber	Amber			KXPB34AA
Dual	24	Red	Red			KXPB34RR
Dual	24	Green	Green			KXPB34GG
Dual	24	White	White			KXPB34WW
Dual	24	Red	Green			KXPB34RG
Dual	110/120	Amber	Amber			KXPB1AA
Dual	110/120	Red	Red			KXPB1RR
Dual	110/120	Green	Green			KXPB1GG
Dual	110/120	White	White			KXPB1WW
Dual	110/120	Red	Green			KXPB1RG
Quad	24	White	Amber	Green	Red	KXPC34WAGR
Quad	110/120	White	Amber	Green	Red	KXPC1WAGR
Quad	110/120	White	Blue	Green	Red	KXPC1WLGR

* Lenses are blank (no markings)

Harmony™ 9001K/SK/KX

30 mm push buttons

9001KX – Legend plates

Note: When ordering, add prefix “9001” to the reference.

Legend Plates for Push Buttons or Pilot Lights

Used On						
	A	B	C	D	E	F
	C (vertical)					
Marking	A	B	C	D	E	F
	KXRA, KXRB, KXRN, KXRP, KXPA, KXPC, KXTA, KXTB, KXTE	KXRC, KXRD, KXRE, KXRF	KXPB, KXTD (3)	KXRG, KXRH, KXRJ, KXRK (1)	KXRL, KXRM, KXTC (2)	KXRL, KXRM, KXTC (1)
Blank	KXN100	KXN200	KXN200	KXN300	KXN400	KXN500
Start	KXN101	KXN201	KXN201V	KXN301	KXN401	KXN501
Stop	KXN102	KXN202	KXN202V	KXN302	KXN402	KXN502
On	KXN103	KXN203	KXN203V	KXN303	KXN403	KXN503
Off	KXN104	KXN204	KXN204V	KXN304	KXN404	KXN504
Emerg. Stop	KXN105	KXN205	KXN205V	KXN305	KXN405	KXN505
Forward	KXN106	KXN206	KXN206V	KXN306	KXN406	KXN506
Reverse	KXN107	KXN207	KXN207V	KXN307	KXN407	KXN507
Close	KXN108	KXN208	KXN208V	KXN308	KXN408	KXN508
Open	KXN109	KXN209	KXN209V	KXN309	KXN409	KXN509
Down	KXN110	KXN210	KXN210V	KXN310	KXN410	KXN510
Up	KXN111	KXN211	KXN211V	KXN311	KXN411	KXN511
Jog	KXN118	KXN218	KXN218V	KXN318	KXN418	KXN518
Reset	KXN123	KXN223	KXN223V	KXN323	KXN423	KXN523
Run	KXN124	KXN224	KXN224V	KXN324	KXN424	KXN524
Cycle Start	KXN132	KXN232	KXN232V	KXN332	KXN432	KXN532
Motor Run	KXN136	KXN236	KXN236V	KXN336	KXN436	KXN536
Power On	KXN138	KXN238	KXN238V	KXN338	KXN438	KXN538
Special-Marking	KXN199	KXN299	KXN299V	KXN399	KXN499	KXN599

- (1) These legend inserts are for the pilot lights in the center of the operator.
- (2) These legend inserts are for the push button portion of the operator.
- (3) These legend inserts have vertical printing.

Legend Plates for Selector Switches

Used On		
	KXN-600	KXN-700
Marking	KXSA, KXSB, KXSC, KXSD, KXSE, KXSF, KXSG, KXSH, KXSJ, KXSK, KXSL, KXSM, KXSN, KXSO, KXSP, KXSQ	KXSR, KXSS, KXST, KXSV, KXSW, KXSX, KXSZ
Blank	KXN600	KXN700
For.-Rev.	KXN639	KXN739
Hand-Auto	KXN640	KXN740
Man-Auto	KXN643	KXN743
Off-On	KXN644	KXN744
On-Off	KXN645	KXN745
Open-Close	KXN646	KXN746
Start-Stop	KXN651	KXN751
Auto-Off-Hand	KXN658	KXN758
Hand-Off-Auto	KXN660	KXN760
Man-Off-Auto	KXN662	KXN762
Special Marking	KXN699	KXN799

Dual Dimensions: in (mm)



Letter Height For Standard Legends

Reference	in	mm
KXN100	1/4	6
KXN200	3/16	4.75
KXN300	3/16	4.75
KXN400	3/16	4.75
KXN500	3/16	4.75
KXN600	1/8	3
KXN700	1/8	3

Maximum Number of Lines and Characters For 9001KXN Legend Inserts

Letter Height in mm	Number of to	KXN199		KXN299		KXN399		KXN499		KXN599	
		Horizontal	Vertical	Horizontal	Vertical	Horizontal	Vertical	Horizontal	Vertical	Horizontal	Vertical
1/4 6	Characters per Line	7	7	3	7	7	3	7	7	3	3
	Lines per Legend Insert	4	2	4	1	1	1	1	1	1	1
3/16 4.75	Characters per Line	9	9	4	9	9	4	9	9	4	4
	Lines per Legend Insert	5	2	6	2	1	1	2	1	2	2
1/8 3	Characters per Line	14	14	5	14	14	5	14	14	6	6
	Lines per Legend Insert	8	4	9	3	2	3	3	2	3	3

Maximum Number of Lines and Characters for 9001KXN699 and 9001KXN799 Legend Plates

Position	Letter Height		Characters Per Marking Area		
	in	mm	A and C	B	
	3/16	4.75	6	6	
	1/8	3	8	9	
	3/16	4.75	10	5	
	1/8	3	13	7	

All 9001KX push buttons and pilot lights have a blank insert as standard. These blank inserts can be custom marked using a marking pen, a mechanical lettering set, press letters, or a tape lettering machine that marks a tape which can then be transferred to the blank insert.

To have legend inserts installed into the operators, order the operator as normal and then indicate where to install the legend inserts using the numbered positions shown on the operator ordered.

Example: 9001KXRL1GRGRH2 with a 9001KXN 401 in position 1, 9001KXN 503 in position 2, 9001KXN 504 in position 3, 9001KXN 402 in position 4

Harmony™ 9001K/SK/KX

30 mm push buttons

9001KX – Accessories

Note: When ordering, add prefix “9001” to the reference.

Closing Plate



Reference
KXAK52

UL Types 4, 13/NEMA 4, 13
Square Closing Plate (Chrome Plated)
Same size as KX bezel

Boots



For Use On	Reference
All KX** push buttons and pilot lights	KXAKU7
All KX** selector switches and potentiometers	KXAKU17B

Shrouds



Description	For Use On	Color	Reference
Full Shroud	All push buttons and pilot lights	Red	KXAK41R
		Black	KXAK41B
Short Shroud	Any KX operator	Red	KXAK40R
		Black	KXAK40B

Lamp and Lens Removal Kit



Used to remove lamp and lens on all
illuminated operators and pilot lights.

Reference
KXALLRT

Button Covers

Description	For Use On	Color	Reference	Code
Includes 2-KXN200	KXPB KXTD	Red	KXAC28 (1)	R (2)
		Green	KXAC28 (1)	G (2)
		Amber	KXAC28 (1)	A (2)
		Blue	KXAC28 (1)	L (2)
		White	KXAC28 (1)	W (2)
Includes KXN400	KXTC (Position 1 & 4)	Red	KXAR4	R
		Green	KXAG4	G
		Amber	KXAA4	A
		Blue	KXAL4	L
		White	KXAW4	W
Includes KXN500	KXTC (Position 2 & 3)	Red	KXAR5	R
		Green	KXAG5	G
		Amber	KXAA5	A
		Blue	KXAL5	L
		White	KXAW5	W
Includes 1-KXN100	KXPC	Red	KXAC48 (3)	R (4)
		Green	KXAC48 (3)	G (4)
		Amber	KXAC48 (3)	A (4)
		Blue	KXAC48 (3)	L (4)
		White	KXAC48 (3)	W (4)
Includes KXN100	KXRA KXRB	Red	KXAR1	R
		Green	KXAG1	G
		Amber	KXAA1	A
		Blue	KXAL1	L
		White	KXAW1	W
Includes KXN100	KXRN KXRP	Red	KXARM1	R
		Green	KXAGM1	G
		Amber	KXAA1	A
		Blue	KXALM1	L
		White	KXAWM1	W
Includes KXN200	KXRC KXRD KXRE KXRF	Red	KXAR2	R
		Green	KXAG2	G
		Amber	KXAA2	A
		Blue	KXAL2	L
		White	KXAW2	W
Includes KXN300	KXRG (Position 2) KXRH (Position 2) KXRJ (Position 2) KXRK (Position 2)	Red	KXAR3	R
		Green	KXAG3	G
		Amber	KXAA3	A
		Blue	KXAL3	L
		White	KXAW3	W
Includes KXN400	KXRG (Position 1 & 3) KXRH (Position 1 & 3) KXRJ (Position 1 & 3) KXRK (Position 1 & 3) KXRL (Position 1 & 4) KXRM (Position 1 & 4)	Red	KXAR4	R
		Green	KXAG4	G
		Amber	KXAA4	A
		Blue	KXAL4	L
		White	KXAW4	W
Includes KXN500	KXRL (Position 2 & 3) KXRM (Position 2 & 3)	Red	KXAR5	R
		Green	KXAG5	G
		Amber	KXAA5	A
		Blue	KXAL5	L
		White	KXAW5	W
Includes KXN100	KXPA	Red	KXAR8	R
		Green	KXAG8	G
		Amber	KXAA8	A
		Blue	KXAL8	L
		White	KXAW8	W
Includes KXN100	KXTA KXTB	Red	KXAR1	R
		Green	KXAG1	G
		Amber	KXAA1	A
		Blue	KXAL1	L
		White	KXAW1	W

- (1) Each KXAC28 includes a clear cover and 1 each of all colors. If the same color is required for position #1 and #2 of the KXPB operator, order 2 of reference KXAC28.
- (2) When specifying color codes—the first will be installed in #1 and the second in #2.
- (3) Each KXAC48 includes a clear cover and 1 each of all colors. If the same color is required for position #1 and #2 of the KXPC operator, order 2 of reference KXAC48.
- (4) When specifying color codes—the first will be installed in #1, the second in #2, the third in #3 and the fourth in #4.
- (5) Two required per operator. When ordering an assembled operator—specify two code numbers. The first code will be assembled into #1 and the second code will be assembled into #2.

Harmony™ 9001K/SK/KX

30 mm push buttons

9001KX

Dimensions

Single Push Button Operator, Non-Illuminated
9001KXRA, 9001KXRN



Selector Switch Operator, Non-Illuminated
9001KXS●



Single Pilot Light

9001KXPA35●, 9001KXPA1●



Dual Push Button Operator, Non-Illuminated

9001KXRC, 9001KXRD, 9001KXRE, 9001KXRF



Key Operator Selector Switch

9001KXS●



Dual Lamp Pilot Light

9001KXPB34●●, 9001KXPB1●●



Single Push Button Operator, Illuminated

9001KXRB, 9001KXRP, 9001KXTA



Selector Switch Operator, Illuminated

9001KXS●



Dual Dimensions: in (mm)

Minimum Centerline Spacings For 9001KX
2-1/4" Vertically 1-5/8" Horizontally

Harmony™ 9001K/SK/KX

30 mm push buttons

9001KX

Dimensions (continued)

Quad Pilot Light

9001KXPC34WAGR, 9001KXPC1W●GR



Dual Push Button Operator, Illuminated

9001KXRG, 9001KXRH, 9001KXRJ, 9001KXRK



Single Potentiometer Operator

9001KXRBB●●



Tandem Potentiometer Operator

9001KXBD83



Dual Lamp Push Button Operator

9001KXRL, 9001KXRM, 9001KXTC



Shroud

9001KXAK41R, 9001KXAK41B, 9001KXAK40R, 9001KXAK40B



Boot

9001KXAKU7, 9001KXAKU17B



Dual Dimensions: in (mm)

Minimum Centerline Spacings For 9001KX
2-1/4" Vertically 1-5/8" Horizontally

Harmony™ 9001K/SK/KX 30 mm push buttons

#		G							
2540902240	19	G19	28, 58	K2L1R20H13	11	K47J●●	14	K701J1	14
2550101002	24, 54	G20	28, 58	K2L1R21H13	11	K47J1	14	K701J1R	14
2550101003	29, 59	G21	28, 58	K2L1RH13	11	K47J1R	14	K702J●●	14
2550101013	24, 54	G22	28, 58	K2L35●	11	K48	27, 57	K702J1	14
2550101020	24, 29, 54, 59	G24	28, 58	K2L35G20H13	11	K49	29	K702J1R	14
2550101025	24, 54	G31	28, 58	K2L35G21H13	11	K49J●●	14	K70H7	18
2550101027	24, 54	G6	28, 58	K2L35GH13	11	K49J1	14	K71	18
2550101036	24, 54	G7	28, 58	K2L35R20H13	11	K49J1R	14	K71H7	18
2550101037	24, 54	G8	28, 58	K2L35R21H13	11	K5	27, 57	K72	18
2550105003	29, 59	G9	28, 58	K2L35RH13	11	K50	19	K72H7	18
2550105004	29, 59	K		K2L7●	11	K50J●●	14	K72J●●	14
2550105005	29, 59	K1	29, 59	K2L7G20H13	11	K50J1	14	K72J1	14
2550105007	29, 59	K107	27, 57	K2L7G21H13	11	K50J1R	14	K72J1R	14
2550105008	29, 59	K108	27, 57	K2L7GH13	11	K50J●●	14	K73	18
2550105009	29, 59	K109	27, 57	K2L7R20H13	11	K50J1	14	K73H7	18
2550105010	29, 59	K110	27, 57	K2L7R21H13	11	K50J1R	14	K73J1	14
2550105014	29, 59	K111	29	K2L7RH13	11	K51	27, 57	K73J1R	14
2941101100	29, 59	K11J●●	13	K3	29, 59	K52	27, 57	K74J●●	14
3105204101	29, 59	K11J1	13	K30	18	K52J●●	14	K74J1	14
3105205901	29, 59	K11J1R	13	K30H8	18	K52J1	14	K74J1R	14
3105206750	19	K12J●●	13	K31	18	K52J1R	14	K75J●●	14
3105211101	19	K12J1	13	K31H8	18	K53J●●	14	K75J1	14
3105217001	29, 59	K12J1R	13	K32	18	K53J1	14	K75J1R	14
3105404408	29, 59	K13B	28, 58	K32H8	18	K53J1R	14	K76J●●	14
3105406401	29, 59	K13C	28, 58	K33	18	K54	29, 59	K76J1	14
4458D20X3	29, 59	K13D	28, 58	K33H8	18	K54J●●	14	K76J1R	14
4487D63XI	29, 59	K13E	28, 58	K34	18	K54J1	14	K77J●●	14
6508804101	29, 59	K13F	28, 58	K34H2	18	K54J1R	14	K77J1	14
6508805201	24, 54	K13G	28, 58	K34J●●	13	K55	29	K77J1R	14
6508805202	24, 54	K13H	28, 58	K34J1	13	K55J●●	14	K79J●●	14
6508805203	24, 54	K13J	28, 58	K34J1R	13	K55J1	14	K79J1	14
6508805204	24, 54	K13L	28, 58	K35	18	K55J1R	14	K79J1R	14
6508805205	24, 54	K13M	28, 58	K35H2	18	K56●	27, 57	K8	19
6508805206	24, 54	K15	19	K36	18	K56●M	27, 57	K85	19
6508805210	24, 54	K162	27, 57	K36H2	18	K56J●●	14	K92B	28, 58
6508805211	24, 54	K16B	28, 58	K37	18	K56J1	14	K92BM	28, 58
6508805212	24, 54	K16G	28, 58	K37H2	18	K56J1R	14	K92G	28, 58
6508805213	24, 54	K16L	28, 58	K3L	21	K57J●●	14	K92GM	28, 58
6508805214	24, 54	K16R	28, 58	K3L●●	11	K57J1	14	K92L	28, 58
6509701801	29, 59	K16R05	28, 58	K3L●GH13	11	K57J1R	14	K92R	28, 58
6509701901	29, 59	K16S	28, 58	K3L●RH13	11	K58	29	K92RM	28, 58
6509702001	29, 59	K16Y	28, 58	K3L1●	11	K59J●●	14	K92S	28, 58
6509704401	59	K17B	28, 58	K3L1GH13	11	K59J1	14	K92Y	28, 58
6509704901	29, 59	K17G	28, 58	K3L1RH13	11	K59J1R	14	K93B	28, 58
6509705001	29, 59	K17L	28, 58	K3L35●	11	K6	27, 57	K93BM	28, 58
6512231201	29, 59	K17R	28, 58	K3L35GH13	11	K60	27, 57	K93G	28, 58
6512232801	19	K17R05	28, 58	K3L35RH13	11	K60J●●	14	K93GM	28, 58
6512240601	59	K17S	28, 58	K3L7●	11	K60J1	14	K93L	28, 58
6512243201	29, 59	K17Y	28, 58	K3L7GH13	11	K60J1R	14	K93R	28, 58
6515802701	29	K1L	21	K3L7RH13	11	K60J●●	14	K93RM	28, 58
9001K40	19	K1L●●	11	K4	27, 57	K60J1	14	K93S	28, 58
9001K57	19	K1L●GH13	11	K40	29	K60J1R	14	K93Y	28, 58
A		K1L●RH13	11	K40J●●	14	K62	27, 57	K94BM	28, 58
A20	28, 58	K1L1●	11	K40J1	14	K62J●●	14	K94GM	28, 58
A21	28, 58	K1L1GH13	11	K40J1R	14	K62J1R	14	K94RM	28, 58
A22	28, 58	K1L1RH13	11	K402J●●	14	K63J1	14	K95	29, 59
A24	28, 58	K1L35●	11	K402J1	14	K63J1R	14	K95BM	28, 58
A31	28, 58	K1L35GH13	11	K402J1R	14	K64J●●	14	K95GM	28, 58
A6	28, 58	K1L35RH13	11	K41	29	K64J1	14	K95RM	28, 58
A7	28, 58	K1L7●	11	K42	29	K64J1R	14	K96	27, 57
A8	28, 58	K1L7GH13	11	K42J●●	14	K65J●●	14	K97	27, 57
A9	28, 58	K1L7RH13	11	K42J1	14	K65J1	14	KA1	20, 50, 72
B		K25J●●	13	K42J1R	14	K65J1R	14	KA12	20, 50
B11	28, 58	K25J1	13	K43J1	14	K66J●●	14	KA13	20, 50
B19	28, 58	K25J1R	13	K43J1R	14	K66J1	14	KA1G	20, 50
B23	28, 58	K2L	21	K44	29	K66J1R	14	KA2	20, 50, 72
B25	28, 58	K2L●●	11	K44J●●	14	K67J●●	14	KA21	20, 50
C		K2L●G20H13	11	K44J1	14	K67J1	14	KA22	20, 50
C20	28, 58	K2L●G21H13	11	K44J1R	14	K67J1R	14	KA23	20, 50
C21	28, 58	K2L●GH13	11	K45	29	K68	27	KA24	20, 50
C22	28, 58	K2L●R20H13	11	K45J●●	14	K685	27	KA25	20, 50
C24	28, 58	K2L●R21H13	11	K45J1	14	K69	29, 59	KA2G	20, 50
C31	28, 58	K2L●RH13	11	K45J1R	14	K69J●●	14	KA3	20, 50, 72
C6	28, 58	K2L1●	11	K46	29	K69J1	14	KA31	20, 50
C7	28, 58	K2L1G20H13	11	K46J●●	14	K69J1R	14	KA32	20, 50
C8	28, 58	K2L1G21H13	11	K46J1	14	K7	27, 57	KA33	20, 50
C9	28, 58	K2L1GH13	11	K46J1R	14	K70	18	KA34	20, 50
				K47	29	K70J●●	14	KA35	20, 50

Harmony™ 9001K/SK/KX

30 mm push buttons

KA3G	20, 50	KN101BP	25, 55	KN129BP	25, 55	KN159BP	25, 55	KN207BP	25, 55
KA4	20, 50, 72	KN101SP	25, 55	KN129SP	25, 55	KN159SP	25, 55	KN207SP	25, 55
KA41	23, 53	KN101WP	25, 55	KN129WP	25, 55	KN159WP	25, 55	KN207WP	25, 55
KA42	23, 53	KN102RP	25, 55	KN130BP	25, 55	KN160BP	25, 55	KN208	25, 55
KA43	23, 53	KN103BP	25, 55	KN130SP	25, 55	KN160SP	25, 55	KN208BP	25, 55
KA44	23, 53	KN103SP	25, 55	KN130WP	25, 55	KN160WP	25, 55	KN208SP	25, 55
KA45	23, 53	KN103WP	25, 55	KN131BP	25, 55	KN162BP	25, 55	KN208WP	25, 55
KA4G	20, 50	KN104RP	25, 55	KN131SP	25, 55	KN162SP	25, 55	KN209	25, 55
KA5	20, 50, 72	KN105RP	25, 55	KN131WP	25, 55	KN162WP	25, 55	KN209BP	25, 55
KA51	23, 53	KN106BP	25, 55	KN132BP	25, 55	KN163BP	25, 55	KN209SP	25, 55
KA52	23, 53	KN106SP	25, 55	KN132SP	25, 55	KN163SP	25, 55	KN209WP	25, 55
KA53	23, 53	KN106WP	25, 55	KN132WP	25, 55	KN163WP	25, 55	KN210	25, 55
KA54	23, 53	KN107BP	25, 55	KN133BP	25, 55	KN164BP	25, 55	KN210BP	25, 55
KA55	23, 53	KN107SP	25, 55	KN133SP	25, 55	KN164SP	25, 55	KN210SP	25, 55
KA5G	20, 50	KN107WP	25, 55	KN133WP	25, 55	KN164WP	25, 55	KN210WP	25, 55
KA6	20, 50, 72	KN108BP	25, 55	KN134BP	25, 55	KN165BP	25, 55	KN211	25, 55
KA6G	20, 50	KN108SP	25, 55	KN134SP	25, 55	KN165SP	25, 55	KN211BP	25, 55
KM1	24, 54	KN108WP	25, 55	KN134WP	25, 55	KN165WP	25, 55	KN211SP	25, 55
KM11	24, 54	KN109BP	25, 55	KN136BP	25, 55	KN167BP	25, 55	KN211WP	25, 55
KM12	24, 54	KN109SP	25, 55	KN136SP	25, 55	KN167SP	25, 55	KN212	25, 55
KM14	24, 54	KN109WP	25, 55	KN136WP	25, 55	KN167WP	25, 55	KN212BP	25, 55
KM1LG	24, 54	KN110BP	25, 55	KN137BP	25, 55	KN170BP	25, 55	KN212SP	25, 55
KM1LR	24, 54	KN110SP	25, 55	KN137SP	25, 55	KN170SP	25, 55	KN212WP	25, 55
KM1LY	24, 54	KN110WP	25, 55	KN137WP	25, 55	KN170WP	25, 55	KN213	25, 55
KM25	24, 54	KN111BP	25, 55	KN138BP	25, 55	KN176BP	25, 55	KN213BP	25, 55
KM3	24, 54	KN111SP	25, 55	KN138SP	25, 55	KN176SP	25, 55	KN213SP	25, 55
KM31	24, 54	KN111WP	25, 55	KN138WP	25, 55	KN176WP	25, 55	KN213WP	25, 55
KM31LG	24, 54	KN112BP	25, 55	KN139BP	25, 55	KN177BP	25	KN214	25, 55
KM31LR	24, 54	KN112SP	25, 55	KN139SP	25, 55	KN177SP	25, 55	KN214BP	25, 55
KM31LY	24, 54	KN112WP	25, 55	KN139WP	25, 55	KN177WP	25, 55	KN214SP	25, 55
KM32	24, 54	KN113BP	25, 55	KN140BP	25, 55	KN178BP	25	KN214WP	25, 55
KM32LG	24, 54	KN113SP	25, 55	KN140SP	25, 55	KN178SP	25	KN215	25, 55
KM32LR	24, 54	KN113WP	25, 55	KN140WP	25, 55	KN178WP	25	KN215BP	25, 55
KM32LY	24, 54	KN114BP	25, 55	KN141BP	25, 55	KN179BP	25, 55	KN215SP	25, 55
KM33	24, 54	KN114SP	25, 55	KN141SP	25, 55	KN179SP	25, 55	KN215WP	25, 55
KM35	24, 54	KN114WP	25, 55	KN141WP	25, 55	KN179WP	25, 55	KN216	25, 55
KM35LG	24, 54	KN115BP	25, 55	KN142BP	25, 55	KN199AP	26, 56	KN216BP	25, 55
KM35LL	24, 54	KN115SP	25, 55	KN142SP	25, 55	KN199BP	26, 56	KN216SP	25, 55
KM35LR	24, 54	KN115WP	25, 55	KN142WP	25, 55	KN199CP	26, 56	KN216WP	25, 55
KM35LW	24, 54	KN116BP	25, 55	KN143BP	25, 55	KN199GP	26, 56	KN217	25, 55
KM35LY	24, 54	KN116SP	25, 55	KN143SP	25, 55	KN199HP	26, 56	KN217BP	25, 55
KM36	24, 54	KN116WP	25, 55	KN143WP	25, 55	KN199LP	26, 56	KN217SP	25, 55
KM38	24, 54	KN117BP	25, 55	KN144BP	25, 55	KN199RP	26, 56	KN217WP	25, 55
KM38LG	24, 54	KN117SP	25, 55	KN144SP	25, 55	KN199SP	26, 56	KN218	25, 55
KM38LL	24, 54	KN117WP	25, 55	KN144WP	25, 55	KN199WP	26, 56	KN218BP	25, 55
KM38LR	24, 54	KN118BP	25, 55	KN145BP	25, 55	KN199YP	26, 56	KN218SP	25, 55
KM38LW	24, 54	KN118SP	25, 55	KN145SP	25, 55	KN2	21, 26, 51, 56	KN218WP	25, 55
KM38LY	24, 54	KN118WP	25, 55	KN145WP	25, 55	KN200	25, 55	KN219	25, 55
KM3LG	24, 54	KN119BP	25, 55	KN146BP	25, 55	KN200AP	26, 56	KN219BP	25, 55
KM3LR	24, 54	KN119SP	25, 55	KN146SP	25, 55	KN200BP	25, 55	KN219SP	25, 55
KM3LY	24, 54	KN119WP	25, 55	KN146WP	25, 55	KN200CP	26, 56	KN219WP	25, 55
KM40	24, 54	KN120BP	25, 55	KN147BP	25, 55	KN200GP	26, 56	KN220	25, 55
KM5	24, 54	KN120SP	25, 55	KN147SP	25, 55	KN200HP	26, 56	KN220BP	25, 55
KM55	24, 54	KN120WP	25, 55	KN147WP	25, 55	KN200LP	26, 56	KN220SP	25, 55
KM55LG	24, 54	KN121BP	25, 55	KN148BP	25, 55	KN200R	25, 55	KN220WP	25, 55
KM55LR	24, 54	KN121SP	25, 55	KN148SP	25, 55	KN200RP	25, 55	KN221	25, 55
KM55LY	24, 54	KN121WP	25, 55	KN148WP	25, 55	KN200SP	25, 55	KN221BP	25, 55
KM58	24, 54	KN122BP	25, 55	KN150BP	25, 55	KN200WP	25, 55	KN221SP	25, 55
KM58LG	24, 54	KN122SP	25, 55	KN150SP	25, 55	KN200YP	26, 56	KN221WP	25, 55
KM58LR	24, 54	KN122WP	25, 55	KN150WP	25, 55	KN201	25, 55	KN222	25, 55
KM58LY	24, 54	KN123BP	25, 55	KN151BP	25, 55	KN201BP	25, 55	KN222BP	25, 55
KM6	24, 54	KN123SP	25, 55	KN151SP	25, 55	KN201SP	25, 55	KN222SP	25, 55
KM7	24, 54	KN123WP	25, 55	KN151WP	25, 55	KN201WP	25, 55	KN222WP	25, 55
KM7LG	24, 54	KN124BP	25, 55	KN153BP	25, 55	KN202	25, 55	KN223	25, 55
KM7LR	24, 54	KN124SP	25, 55	KN153SP	25, 55	KN202RP	25, 55	KN223BP	25, 55
KM7LY	24, 54	KN124WP	25, 55	KN153WP	25, 55	KN203	25, 55	KN223SP	25, 55
KM8	24, 54	KN125BP	25, 55	KN154BP	25, 55	KN203BP	25, 55	KN223WP	25, 55
KMF1	24, 54	KN125SP	25, 55	KN154SP	25, 55	KN203SP	25, 55	KN224	25, 55
KN100AP	26, 56	KN125WP	25, 55	KN154WP	25, 55	KN203WP	25, 55	KN224BP	25, 55
KN100BP	25, 55	KN126BP	25, 55	KN155BP	25, 55	KN204	25, 55	KN224SP	25, 55
KN100CP	26, 56	KN126SP	25, 55	KN155SP	25, 55	KN204RP	25, 55	KN224WP	25, 55
KN100GP	26, 56	KN126WP	25, 55	KN155WP	25, 55	KN205	25, 55	KN225	25, 55
KN100HP	26, 56	KN127BP	25, 55	KN156BP	25, 55	KN205RP	25, 55	KN225BP	25, 55
KN100LP	26, 56	KN127SP	25, 55	KN156SP	25, 55	KN206	25, 55	KN225SP	25, 55
KN100RP	25, 55	KN127WP	25, 55	KN156WP	25, 55	KN206BP	25, 55	KN225WP	25, 55
KN100SP	25, 55	KN128BP	25, 55	KN158BP	25, 55	KN206SP	25, 55	KN226	25, 55
KN100WP	25, 55	KN128SP	25, 55	KN158SP	25, 55	KN206WP	25, 55	KN226BP	25, 55
KN100YP	26, 56	KN128WP	25, 55	KN158WP	25, 55	KN207	25, 55	KN226SP	25, 55

Harmony™ 9001K/SK/KX 30 mm push buttons

KN226WP	25, 55	KN247BP	25, 55	KN299	26, 56	KN377	25	KN717BP	25, 55
KN227	25, 55	KN247SP	25, 55	KN299AP	26, 56	KN378	25	KN717SP	25, 55
KN227BP	25, 55	KN247WP	25, 55	KN299BP	26, 56	KN379	25, 55	KN717WP	25, 55
KN227SP	25, 55	KN248	25, 55	KN299CP	26, 56	KN399	26, 56	KN718BP	25, 55
KN227WP	25, 55	KN248BP	25, 55	KN299GP	26, 56	KN399R	26, 56	KN718SP	25, 55
KN228	25, 55	KN248SP	25, 55	KN299HP	26, 56	KN4	21, 26, 51, 56	KN718WP	25, 55
KN228BP	25, 55	KN248WP	25, 55	KN299LP	26, 56	KN400	26, 56	KN719BP	25, 55
KN228SP	25, 55	KN250	25, 55	KN299R	26, 56	KN499	26, 56	KN719SP	25, 55
KN228WP	25, 55	KN250BP	25, 55	KN299RP	26, 56	KN5	21, 26, 51, 56	KN719WP	25, 55
KN229	25, 55	KN250SP	25, 55	KN299SP	26, 56	KN500	26, 56	KN720BP	25, 55
KN229BP	25, 55	KN250WP	25, 55	KN299WP	26, 56	KN501	26, 56	KN720SP	25, 55
KN229SP	25, 55	KN251	25, 55	KN299YP	26, 56	KN502	26, 56	KN720WP	25, 55
KN229WP	25, 55	KN251BP	25, 55	KN3	21, 26, 51, 56	KN519	26, 56	KN721BP	25, 55
KN230	25, 55	KN251SP	25, 55	KN300	25, 55	KN520	26, 56	KN721SP	25, 55
KN230BP	25, 55	KN251WP	25, 55	KN300R	25, 55	KN521	26, 56	KN721WP	25, 55
KN230SP	25, 55	KN253	25, 55	KN301	25, 55	KN522	26, 56	KN722BP	25, 55
KN230WP	25, 55	KN253BP	25, 55	KN302	25, 55	KN523	26, 56	KN722SP	25, 55
KN231	25, 55	KN253SP	25, 55	KN303	25, 55	KN524	26, 56	KN722WP	25, 55
KN231BP	25, 55	KN253WP	25, 55	KN304	25, 55	KN525	26, 56	KN723BP	25, 55
KN231SP	25, 55	KN254	25, 55	KN305	25, 55	KN526	26, 56	KN723SP	25, 55
KN231WP	25, 55	KN254BP	25, 55	KN306	25, 55	KN599	26, 56	KN723WP	25, 55
KN232	25, 55	KN254SP	25, 55	KN307	25, 55	KN6	21, 26, 51, 56	KN724BP	25, 55
KN232BP	25, 55	KN254WP	25, 55	KN308	25, 55	KN600	26, 56	KN724SP	25, 55
KN232SP	25, 55	KN255	25, 55	KN309	25, 55	KN600R	26, 56	KN724WP	25, 55
KN232WP	25, 55	KN255BP	25, 55	KN310	25, 55	KN699	26, 56	KN725BP	25, 55
KN233	25, 55	KN255SP	25, 55	KN311	25, 55	KN699R	26, 56	KN725SP	25, 55
KN233BP	25, 55	KN255WP	25, 55	KN312	25, 55	KN700AP	26, 56	KN725WP	25, 55
KN233SP	25, 55	KN256	25, 55	KN313	25, 55	KN700BP	26, 55	KN726BP	25, 55
KN233WP	25, 55	KN256BP	25, 55	KN314	25, 55	KN700CP	26, 56	KN726SP	25, 55
KN234	25, 55	KN256SP	25, 55	KN315	25, 55	KN700GP	26, 56	KN726WP	25, 55
KN234BP	25, 55	KN256WP	25, 55	KN316	25, 55	KN700HP	26, 56	KN727BP	25, 55
KN234SP	25, 55	KN258	25, 55	KN317	25, 55	KN700LP	26, 56	KN727SP	25, 55
KN234WP	25, 55	KN258BP	25, 55	KN318	25, 55	KN700RP	25, 55	KN727WP	25, 55
KN236	25, 55	KN258SP	25, 55	KN319	25, 55	KN700SP	25, 55	KN728BP	25, 55
KN236BP	25, 55	KN258WP	25, 55	KN320	25, 55	KN700WP	25, 55	KN728SP	25, 55
KN236SP	25, 55	KN259	25, 55	KN321	25, 55	KN700YP	26, 56	KN728WP	25, 55
KN236WP	25, 55	KN259BP	25, 55	KN322	25, 55	KN701BP	25, 55	KN729BP	25, 55
KN237	25, 55	KN259SP	25, 55	KN323	25, 55	KN701SP	25, 55	KN729SP	25, 55
KN237BP	25, 55	KN259WP	25, 55	KN324	25, 55	KN701WP	25, 55	KN729WP	25, 55
KN237SP	25, 55	KN260	25, 55	KN325	25, 55	KN702RP	25, 55	KN730BP	25, 55
KN237WP	25, 55	KN260BP	25, 55	KN326	25, 55	KN703BP	25, 55	KN730SP	25, 55
KN238	25, 55	KN260SP	25, 55	KN327	25, 55	KN703SP	25, 55	KN730WP	25, 55
KN238BP	25, 55	KN260WP	25, 55	KN328	25, 55	KN703WP	25, 55	KN731BP	25, 55
KN238SP	25, 55	KN262	25, 55	KN329	25, 55	KN704RP	25, 55	KN731SP	25, 55
KN238WP	25, 55	KN262BP	25, 55	KN330	25, 55	KN705RP	25, 55	KN731WP	25, 55
KN239	25, 55	KN262SP	25, 55	KN331	25, 55	KN706BP	25, 55	KN732BP	25, 55
KN239BP	25, 55	KN262WP	25, 55	KN332	25, 55	KN706SP	25, 55	KN732SP	25, 55
KN239SP	25, 55	KN263	25, 55	KN333	25, 55	KN706WP	25, 55	KN732WP	25, 55
KN239WP	25, 55	KN263BP	25, 55	KN334	25, 55	KN707BP	25, 55	KN733BP	25, 55
KN240	25, 55	KN263SP	25, 55	KN336	25, 55	KN707SP	25, 55	KN733SP	25, 55
KN240BP	25, 55	KN263WP	25, 55	KN337	25, 55	KN707WP	25, 55	KN733WP	25, 55
KN240SP	25, 55	KN264	25, 55	KN338	25, 55	KN708BP	25, 55	KN734BP	25, 55
KN240WP	25, 55	KN264BP	25, 55	KN339	25, 55	KN708SP	25, 55	KN734SP	25, 55
KN241	25, 55	KN264SP	25, 55	KN340	25, 55	KN708WP	25, 55	KN734WP	25, 55
KN241BP	25, 55	KN264WP	25, 55	KN341	25, 55	KN709BP	25, 55	KN736BP	25, 55
KN241SP	25, 55	KN265	25, 55	KN342	25, 55	KN709SP	25, 55	KN736SP	25, 55
KN241WP	25, 55	KN265BP	25, 55	KN343	25, 55	KN709WP	25, 55	KN736WP	25, 55
KN242	25, 55	KN265SP	25, 55	KN344	25, 55	KN710BP	25, 55	KN737BP	25, 55
KN242BP	25, 55	KN265WP	25, 55	KN345	25, 55	KN710SP	25, 55	KN737SP	25, 55
KN242SP	25, 55	KN267	25, 55	KN346	25, 55	KN710WP	25, 55	KN737WP	25, 55
KN242WP	25, 55	KN267BP	25, 55	KN347	25, 55	KN711BP	25, 55	KN738BP	25, 55
KN243	25, 55	KN267SP	25, 55	KN348	25, 55	KN711SP	25, 55	KN738SP	25, 55
KN243BP	25, 55	KN267WP	25, 55	KN350	25, 55	KN711WP	25, 55	KN738WP	25, 55
KN243SP	25, 55	KN270	25, 55	KN351	25, 55	KN712BP	25, 55	KN739BP	25, 55
KN243WP	25, 55	KN270BP	25, 55	KN353	25, 55	KN712SP	25, 55	KN739SP	25, 55
KN244	25, 55	KN270SP	25, 55	KN354	25, 55	KN712WP	25, 55	KN739WP	25, 55
KN244BP	25, 55	KN270WP	25, 55	KN355	25, 55	KN713BP	25, 55	KN740BP	25, 55
KN244SP	25, 55	KN276	25, 55	KN356	25, 55	KN713SP	25, 55	KN740SP	25, 55
KN244WP	25, 55	KN276BP	25, 55	KN358	25, 55	KN713WP	25, 55	KN740WP	25, 55
KN245	25, 55	KN276SP	25, 55	KN359	25, 55	KN714BP	25, 55	KN741BP	25, 55
KN245BP	25, 55	KN276WP	25, 55	KN360	25, 55	KN714SP	25, 55	KN741SP	25, 55
KN245SP	25, 55	KN277	25	KN362	25, 55	KN714WP	25, 55	KN741WP	25, 55
KN245WP	25, 55	KN277BP	55	KN363	25, 55	KN715BP	25, 55	KN742BP	25, 55
KN246	25, 55	KN277SP	55	KN364	25, 55	KN715SP	25, 55	KN742SP	25, 55
KN246BP	25, 55	KN277WP	55	KN365	25, 55	KN715WP	25, 55	KN742WP	25, 55
KN246SP	25, 55	KN278BP	25	KN367	25, 55	KN716BP	25, 55	KN743BP	25, 55
KN246WP	25, 55	KN278SP	25	KN370	25, 55	KN716SP	25, 55	KN743SP	25, 55
KN247	25, 55	KN278WP	25	KN376	25, 55	KN716WP	25, 55	KN743WP	25, 55

Harmony™ 9001K/SK/KX

30 mm push buttons

KN744BP	25, 55	KN799SP	26, 56	KP●	17	KR24BH13	10	KR4G	10
KN744SP	25, 55	KN799WP	26, 56	KP●●	17	KR24BH5	10	KR4GH13	10
KN744WP	25, 55	KN799YP	26, 56	KP●G31	17	KR24BH6	10	KR4GH5	10
KN745BP	25, 55	KN800	25, 55	KP●R31	17	KR24BM	10	KR4GH6	10
KN745SP	25, 55	KN800R	25, 55	KP1	17	KR24G	10	KR4R	10
KN745WP	25, 55	KN801	25, 55	KP1●	17	KR24GH13	10	KR4R05	10
KN746BP	25, 55	KN802	25, 55	KP1G31	17	KR24GH5	10	KR4R05H13	10
KN746SP	25, 55	KN803	25, 55	KP1R31	17	KR24GH6	10	KR4R05H5	10
KN746WP	25, 55	KN804	25, 55	KP35	17	KR24GM	10	KR4R05H6	10
KN747BP	25, 55	KN805	25, 55	KP35●	17	KR24R	10	KR4RH13	10
KN747SP	25, 55	KN806	25, 55	KP35G31	17	KR24RH13	10	KR4RH5	10
KN747WP	25, 55	KN807	25, 55	KP35R31	17	KR24RH5	10	KR4RH6	10
KN748BP	25, 55	KN808	25, 55	KP7	17	KR24RH6	10	KR5●	10
KN748SP	25, 55	KN809	25, 55	KP7●	17	KR24RM	10	KR5●H13	10
KN748WP	25, 55	KN810	25, 55	KP7G31	17	KR25●	10	KR5●H5	10
KN750BP	25, 55	KN8100	26, 56	KP7R31	17	KR25●H13	10	KR5●H6	10
KN750SP	25, 55	KN811	25, 55	KQ11	18	KR25●H5	10	KR5B	10
KN750WP	25, 55	KN812	25, 55	KQ11B	18	KR25●H6	10	KR5BH13	10
KN751BP	25, 55	KN813	25, 55	KQ12	18	KR25B	10	KR5BH5	10
KN751SP	25, 55	KN814	25, 55	KQ12B	18	KR25BH13	10	KR5BH6	10
KN751WP	25, 55	KN815	25, 55	KQ13	18	KR25BH5	10	KR5G	10
KN753BP	25, 55	KN816	25, 55	KQ13B	18	KR25BH6	10	KR5GH13	10
KN753WP	25, 55	KN817	25, 55	KQ14	18	KR25BM	10	KR5GH5	10
KN754BP	25, 55	KN818	25, 55	KQ14B	18	KR25G	10	KR5GH6	10
KN754SP	25, 55	KN819	25, 55	KQ15	18	KR25GH13	10	KR5R	10
KN754WP	25, 55	KN820	25, 55	KQ15B	18	KR25GH5	10	KR5R05	10
KN755BP	25, 55	KN821	25, 55	KR1●	10	KR25GH6	10	KR5R05H13	10
KN755SP	25, 55	KN822	25, 55	KR1●H13	10	KR25GM	10	KR5R05H5	10
KN755WP	25, 55	KN823	25, 55	KR1●H5	10	KR25R	10	KR5R05H6	10
KN756BP	25, 55	KN824	25, 55	KR1●H6	10	KR25RH13	10	KR5RH13	10
KN756SP	25, 55	KN825	25, 55	KR11●	19	KR25RH5	10	KR5RH5	10
KN756WP	25, 55	KN826	25, 55	KR11●H1	19	KR25RH6	10	KR5RH6	10
KN758BP	25, 55	KN827	25, 55	KR11U	19	KR25RM	10	KR6	21
KN758SP	25, 55	KN828	25, 55	KR11UH1	19	KR2B	10	KR6●	19
KN758WP	25, 55	KN829	25, 55	KR12●	19	KR2BH13	10	KR6●H37	19
KN759BP	25, 55	KN830	25, 55	KR12●H1H1	19	KR2BH5	10	KR6●H7	19
KN759SP	25, 55	KN831	25, 55	KR12U	19	KR2BH6	10	KR67	21
KN759WP	25, 55	KN832	25, 55	KR12UH1H1	19	KR2G	10	KR67●	19
KN760BP	25, 55	KN833	25, 55	KR131	18	KR2GH13	10	KR67●H37	19
KN760SP	25, 55	KN8330	26, 56	KR132	18	KR2GH5	10	KR67●H7	19
KN760WP	25, 55	KN834	25, 55	KR133	18	KR2GH6	10	KR67GR	19
KN762BP	25, 55	KN836	25, 55	KR137	18	KR2R	10	KR67GRH37	19
KN762SP	25, 55	KN837	25, 55	KR141	18	KR2RH13	10	KR67GRH7	19
KN762WP	25, 55	KN838	25, 55	KR142	18	KR2RH5	10	KR67U	19
KN763BP	25, 55	KN839	25, 55	KR143	18	KR2RH6	10	KR67UH37	19
KN763SP	25, 55	KN840	25, 55	KR147	18	KR2U	10	KR67UH7	19
KN763WP	25, 55	KN841	25, 55	KR152	18	KR2UH13	10	KR6GR	19
KN764BP	25, 55	KN842	25, 55	KR153	18	KR2UH5	10	KR6GRH37	19
KN764SP	25, 55	KN843	25, 55	KR16	12	KR2UH6	10	KR6GRH7	19
KN764WP	25, 55	KN844	25, 55	KR16H13	12	KR3	21	KR6U	19
KN765BP	25, 55	KN845	25, 55	KR16H2	12	KR3●	10	KR6UH37	19
KN765SP	25, 55	KN846	25, 55	KR1B	10	KR3●H13	10	KR6UH7	19
KN765WP	25, 55	KN847	25, 55	KR1BH13	10	KR3●H5	10	KR7	21
KN767BP	25, 55	KN848	25, 55	KR1BH5	10	KR3●H6	10	KR7●	19
KN767SP	25, 55	KN850	25, 55	KR1BH6	10	KR3B	10	KR7●H37	19
KN767WP	25, 55	KN851	25, 55	KR1G	10	KR3BH13	10	KR7●H7	19
KN770BP	25, 55	KN853	25, 55	KR1GH13	10	KR3BH5	10	KR7GR	19
KN770SP	25, 55	KN854	25, 55	KR1GH5	10	KR3BH6	10	KR7GRH37	19
KN770WP	25, 55	KN855	25, 55	KR1GH6	10	KR3G	10	KR7GRH7	19
KN776BP	25, 55	KN856	25, 55	KR1R	10	KR3GH13	10	KR7U	19
KN776SP	25, 55	KN858	25, 55	KR1RH13	10	KR3GH5	10	KR7UH37	19
KN776WP	25, 55	KN859	25, 55	KR1RH5	10	KR3GH6	10	KR7UH7	19
KN777BP	25	KN860	25, 55	KR1RH6	10	KR3R	10	KR8	21
KN777SP	25	KN862	25, 55	KR1U	10	KR3RH13	10	KR8●	12
KN777WP	25	KN863	25, 55	KR1UH13	10	KR3RH5	10	KR8●H25	12
KN778BP	25	KN864	25, 55	KR1UH5	10	KR3RH6	10	KR8G	12
KN778SP	25	KN865	25, 55	KR1UH6	10	KR3U	10	KR8GH25	12
KN778WP	25	KN867	25, 55	KR2	21	KR3UH13	10	KR8P●●	12
KN779BP	25, 55	KN870	25, 55	KR2●	10	KR3UH5	10	KR8P●●H25	12
KN779SP	25, 55	KN876	25, 55	KR2●H13	10	KR3UH6	10	KR8P●RH25	12
KN779WP	25, 55	KN877	25, 55	KR2●H5	10	KR4●	10	KR8P1●	12
KN799AP	26, 56	KN899	26, 56	KR2●H6	10	KR4●H13	10	KR8P1●H25	12
KN799BP	26, 56	KN899R	26, 56	KR20	21	KR4●H5	10	KR8P1RH25	12
KN799CP	26, 56	KN900	26, 56	KR24●	10	KR4●H6	10	KR8R	12
KN799GP	26, 56	KN9100	26, 56	KR24●H13	10	KR4B	10	KR8RH25	12
KN799HP	26, 56	KN9330	26, 56	KR24●H5	10	KR4BH13	10	KR9	21
KN799LP	26, 56	KN999	26, 56	KR24●H6	10	KR4BH5	10	KR9●	12
KN799RP	26, 56	KP	21	KR24B	10	KR4BH6	10	KR9●H13	12

Harmony™ 9001K/SK/KX 30 mm push buttons

KR9BM94	12	KS47	14	KS73	14	KXAG4	75	KXN211V	74
KR9BM95	12	KS47●	14	KS73●	14	KXAG5	75	KXN218	74
KR9G	12	KS47BH1	14	KS73K●	14	KXAG8	75	KXN218V	74
KR9GH13	12	KS47BH13	14	KS74	14	KXAGM1	75	KXN223	74
KR9GM94	12	KS47BH2	14	KS74●	14	KXAK40B	75	KXN223V	74
KR9GM95	12	KS47K●	14	KS74K●	14	KXAK40R	75	KXN224	74
KR9P●●	12	KS49	14	KS75	14	KXAK41B	75	KXN224V	74
KR9P●●H13	12	KS49●	14	KS75●	14	KXAK41R	75	KXN232	74
KR9P●RH13	12	KS49BH1	14	KS75K●	14	KXAK52	75	KXN232V	74
KR9P1●	12	KS49BH13	14	KS76	14	KXAKU17B	75	KXN236	74
KR9P1●H13	12	KS49BH2	14	KS76●	14	KXAKU7	75	KXN236V	74
KR9P1RH13	12	KS49K●	14	KS76K●	14	KXAL1	75	KXN238	74
KR9R	12	KS5	21	KS77	14	KXAL2	75	KXN238V	74
KR9R94	12	KS501	14	KS77●	14	KXAL3	75	KXN299	74
KR9R94H13	12	KS501●	14	KS77K●	14	KXAL4	75	KXN299V	74
KR9RH13	12	KS501K●	14	KS79	14	KXAL5	75	KXN300	74
KR9RM94	12	KS502	14	KS79●	14	KXAL8	75	KXN301	74
KR9RM95	12	KS502●	14	KS79K●	14	KXALLRT	75	KXN302	74
KRD1UH1	19	KS502K●	14	KS88	15	KXALM1	75	KXN303	74
KRD1UH2	19	KS52	14	KS88●	15	KXAR1	75	KXN304	74
KRD2UH1	19	KS52●	14	KS88J●●	15	KXAR2	75	KXN305	74
KRD2UH2	19	KS52K●	14	KS88J1	15	KXAR3	75	KXN306	74
KRD3UH1	19	KS53	14	KS88J1R	15	KXAR4	75	KXN307	74
KRD3UH2	19	KS53●	14	KS88K●	15	KXAR5	75	KXN308	74
KS11	13	KS53K●	14	KT●	17	KXAR8	75	KXN309	74
KS11BH1	13	KS54	14	KT●●	17	KXARM1	75	KXN310	74
KS11BH13	13	KS54●	14	KT●G31	17	KXAW1	75	KXN311	74
KS11BH2	13	KS54K●	14	KT●R31	17	KXAW2	75	KXN318	74
KS11K	13	KS55	14	KT1	17	KXAW3	75	KXN323	74
KS12	13	KS55●	14	KT1●	17	KXAW4	75	KXN324	74
KS12K	13	KS55K●	14	KT1G31	17	KXAW5	75	KXN332	74
KS25	13	KS56	14	KT1R31	17	KXAW8	75	KXN336	74
KS25K2●	13	KS56●	14	KT35	17	KXAWM1	75	KXN338	74
KS34	13	KS56K●	14	KT35●	17	KXBB06	72	KXN399	74
KS34K1	13	KS57	14	KT35G31	17	KXBB07	72	KXN400	74
KS4	21	KS57●	14	KT35R31	17	KXBB08	72	KXN401	74
KS401	14	KS57K●	14	KT7	17	KXBD83	72	KXN402	74
KS401●	14	KS59	14	KT7●	17	KXN100	74	KXN403	74
KS401BH1	14	KS59●	14	KT7G31	17	KXN101	74	KXN404	74
KS401BH13	14	KS59K●	14	KT7R31	17	KXN102	74	KXN405	74
KS401BH2	14	KS6	21	KTR●	17	KXN103	74	KXN406	74
KS401K●	14	KS601	14	KTR●●	17	KXN104	74	KXN407	74
KS402	14	KS601●	14	KTR●G31	17	KXN105	74	KXN408	74
KS402●	14	KS601K●	14	KTR●R31	17	KXN106	74	KXN409	74
KS402BH1	14	KS602	14	KTR35	17	KXN107	74	KXN410	74
KS402BH13	14	KS602●	14	KTR35●	17	KXN108	74	KXN411	74
KS402BH2	14	KS602K●	14	KTR35G31	17	KXN109	74	KXN418	74
KS402K●	14	KS62	14	KTR35R31	17	KXN110	74	KXN423	74
KS42	14	KS62●	14	KTR38	17	KXN111	74	KXN424	74
KS42●	14	KS62K●	14	KTR38●	17	KXN118	74	KXN432	74
KS42BH1	14	KS63	14	KTR38G31	17	KXN123	74	KXN436	74
KS42BH13	14	KS63●	14	KTR38R31	17	KXN124	74	KXN438	74
KS42BH2	14	KS63K●	14	KU1	27	KXN132	74	KXN499	74
KS42K●	14	KS64	14	KU17	27, 57	KXN136	74	KXN500	74
KS43	14	KS64●	14	KU18	27, 57	KXN138	74	KXN501	74
KS43●	14	KS64K●	14	KU2	27	KXN199	74	KXN502	74
KS43BH1	14	KS65	14	KU27	27, 57	KXN200	74	KXN503	74
KS43BH13	14	KS65●	14	KU3	27	KXN201	74	KXN504	74
KS43BH2	14	KS65K●	14	KU37	27, 57	KXN201V	74	KXN505	74
KS43K●	14	KS66	14	KU4	27	KXN202	74	KXN506	74
KS44	14	KS66●	14	KU47	27, 57	KXN202V	74	KXN507	74
KS44●	14	KS66K●	14	KU5	27	KXN203	74	KXN508	74
KS44BH1	14	KS67	14	KU6	27	KXN203V	74	KXN509	74
KS44BH13	14	KS67●	14	KU7	27	KXN204	74	KXN510	74
KS44BH2	14	KS67K●	14	KU8	27	KXN204V	74	KXN511	74
KS44K●	14	KS69	14	KX		KXN205	74	KXN518	74
KS45	14	KS69●	14	KXAA1	75	KXN205V	74	KXN523	74
KS45●	14	KS69K●	14	KXAA2	75	KXN206	74	KXN524	74
KS45BH1	14	KS7	21	KXAA3	75	KXN206V	74	KXN532	74
KS45BH13	14	KS701	14	KXAA4	75	KXN207	74	KXN536	74
KS45BH2	14	KS701●	14	KXAA5	75	KXN207V	74	KXN538	74
KS45K●	14	KS701K●	14	KXAA8	75	KXN208	74	KXN599	74
KS46	14	KS702	14	KXAAAM1	75	KXN208V	74	KXN600	74
KS46●	14	KS702●	14	KXAC28	75	KXN209	74	KXN639	74
KS46BH1	14	KS702K●	14	KXAC48	75	KXN209V	74	KXN640	74
KS46BH13	14	KS72	14	KXAG1	75	KXN210	74	KXN643	74
KS46BH2	14	KS72●	14	KXAG2	75	KXN210V	74	KXN644	74
KS46K●	14	KS72K●	14	KXAG3	75	KXN211	74	KXN645	74

Harmony™ 9001K/SK/KX

30 mm push buttons

KXN646	74	KXRG117	70	SK1L	51	SK46J1R	45	SK75J1	45
KXN651	74	KXRG137	70	SK1L●	42	SK47J●●	45	SK75J1R	45
KXN658	74	KXRG35GWG	71	SK1L●GH13	42	SK47J1	45	SK76J●●	45
KXN660	74	KXRG35RWG	71	SK1L●RH13	42	SK47J1R	45	SK76J1	45
KXN662	74	KXRG38GWG	71	SK1L1	42	SK49	59	SK76J1R	45
KXN699	74	KXRG38RWG	71	SK1L1GH13	42	SK49J●●	45	SK77J●●	45
KXN700	74	KXRH354GWG	71	SK1L1RH13	42	SK49J1	45	SK77J1	45
KXN739	74	KXRH35RWG	71	SK1L35	42	SK49J1R	45	SK77J1R	45
KXN740	74	KXRH38GWG	71	SK1L35GH13	42	SK501J●●	45	SK79J●●	45
KXN743	74	KXRH38RWG	71	SK1L35RH13	42	SK501J1	45	SK79J1	45
KXN744	74	KXRJ119	70	SK1L7	42	SK501J1R	45	SK79J1R	45
KXN745	74	KXRJ35GWG	71	SK1L7GH13	42	SK502J●●	45	SK88J●●	46
KXN746	74	KXRJ35RWG	71	SK1L7RH13	42	SK502J1	45	SK88J1	46
KXN751	74	KXRJ38GWG	71	SK20	46	SK502J1R	45	SK88J1R	46
KXN758	74	KXRJ38RWG	71	SK21	46	SK52J●●	45	SKP	51
KXN760	74	KXRL121	70	SK22	46	SK52J1	45	SKP●	48
KXN762	74	KXRL138	70	SK23	46	SK52J1R	45	SKP●●	48
KXN799	74	KXRL34GRGRH2	70	SK25J●●	44	SK53J●●	45	SKP●G31	48
KXPA1A	73	KXRL34GRGRH37	70	SK25J1	44	SK53J1	45	SKP●R31	48
KXPA1G	73	KXRL35GGRR	71	SK25J1R	44	SK53J1R	45	SKP1	48
KXPA1R	73	KXRL35RWWG	71	SK2L	51	SK54J●●	45	SKP1●	48
KXPA1W	73	KXRL38GGRR	71	SK2L●	42	SK54J1	45	SKP1G31	48
KXPA35A	73	KXRL38RWWG	71	SK2L●G20H13	42	SK54J1R	45	SKP1R31	48
KXPA35G	73	KXRM35RRGG	71	SK2L●G21H13	42	SK55J●●	45	SKP35	48
KXPA35R	73	KXRM35RWWG	71	SK2L●GH13	42	SK55J1	45	SKP35●	48
KXPA35W	73	KXRM38RRGG	71	SK2L●R20H13	42	SK55J1R	45	SKP35G31	48
KXPB1AA	73	KXRM38RWWG	71	SK2L●R21H13	42	SK56J●●	45	SKP35R31	48
KXPB1GG	73	KXSA125	72	SK2L●RH13	42	SK56J1	45	SKP7	48
KXPB1RG	73	KXSA139	72	SK2L1	42	SK56J1R	45	SKP7●	48
KXPB1RR	73	KXSAEB	72	SK2L1G20H13	42	SK57J●●	45	SKP7G31	48
KXPB1WW	73	KXSD126	72	SK2L1G21H13	42	SK57J1	45	SKP7R31	48
KXPB34AA	73	KXSDCB	72	SK2L1GH13	42	SK57J1R	45	SKR1●	41
KXPB34GG	73	KXSHHB	72	SK2L1R20H13	42	SK59J●●	45	SKR1●H13	41
KXPB34RG	73	KXSJE35G	72	SK2L1R21H13	42	SK59J1	45	SKR1●H5	41
KXPB34RR	73	KXSJE35R	72	SK2L1RH13	42	SK59J1R	45	SKR1●H6	41
KXPB34WW	73	KXSJE35W	72	SK2L35	42	SK601J●●	45	SKR11●	49
KXPC1WAGR	73	KXSJE38G	72	SK2L35G20H13	42	SK601J1	45	SKR11●H1	49
KXPC1WLGR	73	KXSJE38R	72	SK2L35G21H13	42	SK601J1R	45	SKR11U	49
KXPC34WAGR	73	KXSJE38W	72	SK2L35GH13	42	SK602J●●	45	SKR11UH1	49
KXRA133	70	KXSRE1	72	SK2L35R20H13	42	SK602J1	45	SKR12●	49
KXRA134	70	KXSRE2	72	SK2L35R21H13	42	SK602J1R	45	SKR12●H1H1	49
KXRAA	71	KXSRE3	72	SK2L35RH13	42	SK62J●●	45	SKR12U	49
KXRAAH2	70	KXSVC10	72	SK2L7	42	SK62J1	45	SKR12UH1H1	49
KXRAG	71	KXSVC5	72	SK2L7G20H13	42	SK62J1R	45	SKR16	43
KXRAGH2	70	L		SK2L7G21H13	42	SK63J●●	45	SKR16H13	43
KXRAL	71	L20	28, 58	SK2L7GH13	42	SK63J1	45	SKR16H2	43
KXRALH2	70	L21	28, 58	SK2L7R20H13	42	SK63J1R	45	SKR1B	41
KXRAR	71	L22	28, 58	SK2L7R21H13	42	SK64J●●	45	SKR1BH13	41
KXRAW	71	L24	28, 58	SK2L7RH13	42	SK64J1	45	SKR1BH5	41
KXRB1AH1	70	L31	28, 58	SK34J●●	44	SK64J1R	45	SKR1BH6	41
KXRB1GH1	70	L6	28, 58	SK34J1	44	SK65J●●	45	SKR1G	41
KXRB1RH1	70	L7	28, 58	SK34J1R	44	SK65J1	45	SKR1GH13	41
KXRB34AH1	70	L8	28, 58	SK40	59	SK65J1R	45	SKR1GH5	41
KXRB34GH1	70	L9	28, 58	SK401J●●	45	SK66J●●	45	SKR1GH6	41
KXRB34RH1	70	R		SK401J1	45	SK66J1	45	SKR1R	41
KXRB35A	71	R19	28, 58	SK401J1R	45	SK66J1R	45	SKR1RH13	41
KXRB35G	71	R20	28, 58	SK402J●●	45	SK67J●●	45	SKR1RH5	41
KXRB35L	71	R21	28, 58	SK402J1	45	SK67J1	45	SKR1RH6	41
KXRB35R	71	R22	28, 58	SK402J1R	45	SK67J1R	45	SKR1U	41
KXRB35W	71	R2205	28, 58	SK41	59	SK69J●●	45	SKR1UH13	41
KXRB38A	71	R24	28, 58	SK42	59	SK69J1	45	SKR1UH5	41
KXRB38G	71	R31	28, 58	SK42J●●	45	SK69J1R	45	SKR1UH6	41
KXRB38L	71	R6	28, 58	SK42J1	45	SK701J●●	45	SKR2	51
KXRB38R	71	R7	28, 58	SK42J1R	45	SK701J1	45	SKR2●	41
KXRB38W	71	R8	28, 58	SK43J●●	45	SK701J1R	45	SKR2●H5	41
KXRC111	70	R9	28, 58	SK43J1	45	SK702J●●	45	SKR2●H6	41
KXRC136	70	R94	28, 58	SK43J1R	45	SK702J1	45	SKR20	51
KXRCGG	71	S		SK44	59	SK702J1R	45	SKR24●	41
KXRCGR	71	S11	28, 58	SK44J●●	45	SK72J●●	45	SKR24●H13	41
KXRCWW	71	S23	28, 58	SK44J1	45	SK72J1	45	SKR24●H5	41
KXRD140	70	S25	28, 58	SK44J1R	45	SK72J1R	45	SKR24●H6	41
KXRDLLH7	70	SK		SK45	59	SK73J●●	45	SKR24B	41
KXRE115	70	SK11J●●	44	SK45J●●	45	SK73J1	45	SKR24BH13	41
KXREGG	71	SK11J1	44	SK45J1	45	SK73J1R	45	SKR24BH5	41
KXREGR	71	SK11J1R	44	SK45J1R	45	SK74J●●	45	SKR24BH6	41
KXRELLH2	70	SK12J●●	44	SK46	59	SK74J1	45	SKR24G	41
KXRELLH3	70	SK12J1	44	SK46J●●	45	SK74J1R	45	SKR24GH13	41
KXREWW	71	SK12J1R	44	SK46J1	45	SK75J●●	45	SKR24GH5	41

Harmony™ 9001K/SK/KX 30 mm push buttons

SKR24GH6	41	SKR5●	41	SKS44	45	SKS77●	45
SKR24R	41	SKR5●H13	41	SKS44●	45	SKS79	45
SKR24RH13	41	SKR5●H5	41	SKS44BH1	45	SKS79●	45
SKR24RH5	41	SKR5●H6	41	SKS44BH13	45	SKS88	46
SKR24RH6	41	SKR5B	41	SKS44BH2	45	SKS88●	46
SKR25●	41	SKR5BH13	41	SKS45	45	SKT●	48
SKR25●H13	41	SKR5BH5	41	SKS45●	45	SKT●●	48
SKR25●H5	41	SKR5BH6	41	SKS45BH1	45	SKT●G31	48
SKR25●H6	41	SKR5G	41	SKS45BH13	45	SKT●R31	48
SKR25B	41	SKR5GH13	41	SKS45BH2	45	SKT1	48
SKR25BH13	41	SKR5GH5	41	SKS46	45	SKT1●	48
SKR25BH5	41	SKR5GH6	41	SKS46●	45	SKT1G31	48
SKR25BH6	41	SKR5R	41	SKS46BH1	45	SKT1R31	48
SKR25G	41	SKR5R05	41	SKS46BH13	45	SKT35	48
SKR25GH13	41	SKR5R05H13	41	SKS47	45	SKT35●	48
SKR25GH5	41	SKR5R05H5	41	SKS47●	45	SKT35G31	48
SKR25GH6	41	SKR5R05H6	41	SKS47BH1	45	SKT35R31	48
SKR25R	41	SKR5RH13	41	SKS47BH13	45	SKT7	48
SKR25RH13	41	SKR5RH5	41	SKS47BH2	45	SKT7●	48
SKR25RH5	41	SKR5RH6	41	SKS49	45	SKT7G31	48
SKR25RH6	41	SKR8	51	SKS49●	45	SKT7R31	48
SKR2B	41	SKR8●	43	SKS49BH1	45	SKTR●	48
SKR2BH13	41	SKR8●H25	43	SKS49BH13	45	SKTR●●	48
SKR2BH5	41	SKR8G	43	SKS49BH2	45	SKTR●G31	48
SKR2BH6	41	SKR8GH25	43	SKS5	51	SKTR●R31	48
SKR2G	41	SKR8P●●	43	SKS501	45	SKTR35	48
SKR2GH13	41	SKR8P●●H25	43	SKS501●	45	SKTR35●	48
SKR2GH5	41	SKR8P●RH25	43	SKS502	45	SKTR35G31	48
SKR2GH6	41	SKR8P1●	43	SKS502●	45	SKTR35R31	48
SKR2R	41	SKR8P1●H25	43	SKS52	45	SKTR38	48
SKR2RH13	41	SKR8P1RH25	43	SKS52●	45	SKTR38●	48
SKR2RH5	41	SKR8R	43	SKS53	45	SKTR38G31	48
SKR2RH6	41	SKR8RH25	43	SKS53●	45	SKTR38R31	48
SKR2U	41	SKR9	51	SKS54	45	SS	
SKR2UH13	41	SKR9●	43	SKS54●	45	SSKS46BH2	45
SKR2UH5	41	SKR9●H13	43	SKS55	45	T	
SKR2UH6	41	SKR9G	43	SKS55●	45	T5BE	28, 58
SKR3	51	SKR9GH13	43	SKS56	45	T5BK	28, 58
SKR3●	41	SKR9P●●	43	SKS56●	45	T5GN	28, 58
SKR3●H13	41	SKR9P●●H13	43	SKS57	45	T5OE	28, 58
SKR3●H5	41	SKR9P●RH13	43	SKS57●	45	T5RD	28, 58
SKR3●H6	41	SKR9P1●	43	SKS59	45	T5WH	28, 58
SKR3B	41	SKR9P1●H13	43	SKS59●	45	T5YW	28, 58
SKR3BH13	41	SKR9P1RH13	43	SKS6	51	T8BE	28, 58
SKR3BH5	41	SKR9R	43	SKS601	45	T8BK	28, 58
SKR3BH6	41	SKR9RH13	43	SKS601●	45	T8GN	28, 58
SKR3G	41	SKS11	44	SKS602	45	T8GY	28, 58
SKR3GH13	41	SKS11●	44	SKS602●	45	T8OE	28, 58
SKR3GH5	41	SKS11BH1	44	SKS62	45	T8RD	28, 58
SKR3GH6	41	SKS11BH13	44	SKS62●	45	T8U	28, 58
SKR3R	41	SKS11BH2	44	SKS63	45	T8WH	28, 58
SKR3RH13	41	SKS12	44	SKS63●	45	T8YW	28, 58
SKR3RH5	41	SKS12●	44	SKS64	45	U	
SKR3RH6	41	SKS25	44	SKS64●	45	U19	28, 58
SKR3U	41	SKS25●	44	SKS65	45	W	
SKR3UH13	41	SKS34	44	SKS65●	45	W20	28, 58
SKR3UH5	41	SKS34●	44	SKS66	45	W21	28, 58
SKR3UH6	41	SKS4	51	SKS66●	45	W22	28, 58
SKR4●	41	SKS401	45	SKS67	45	W24	28, 58
SKR4●H13	41	SKS401●	45	SKS67●	45	W31	28, 58
SKR4●H5	41	SKS401BH1	45	SKS69	45	W6	28, 58
SKR4●H6	41	SKS401BH13	45	SKS69●	45	W7	28, 58
SKR4B	41	SKS401BH2	45	SKS7	51	W8	28, 58
SKR4BH13	41	SKS402	45	SKS701	45	W9	28, 58
SKR4BH5	41	SKS402●	45	SKS701●	45	Y	
SKR4BH6	41	SKS402BH1	45	SKS702	45	Y20	28, 58
SKR4G	41	SKS402BH13	45	SKS702●	45	Y21	28, 58
SKR4GH13	41	SKS402BH2	45	SKS72	45	Y22	28, 58
SKR4GH5	41	SKS42	45	SKS72●	45	Y24	28, 58
SKR4GH6	41	SKS42●	45	SKS73	45	Y31	28, 58
SKR4R	41	SKS42BH1	45	SKS73●	45	Y6	28, 58
SKR4R05	41	SKS42BH13	45	SKS74	45	Y7	28, 58
SKR4R05H13	41	SKS42BH2	45	SKS74●	45	Y8	28, 58
SKR4R05H5	41	SKS43	45	SKS75	45	Y9	28, 58
SKR4R05H6	41	SKS43●	45	SKS75●	45		
SKR4RH13	41	SKS43BH1	45	SKS76	45		
SKR4RH5	41	SKS43BH13	45	SKS76●	45		
SKR4RH6	41	SKS43BH2	45	SKS77	45		

<http://www.schneider-electric.us/>

Schneider Electric USA, Inc.

8001 Knightdale Blvd.
Knightdale, NC 27545

USA Customer Care Center
Tel: 888-778-2733

Schneider Electric Canada

5985 McLaughlin Rd.
Mississauga, Ontario, Canada L5R 1B8

Canada Customer Care Center
Tel: 800-565-6699

The information and dimensions in this catalog are provided for the convenience of our customers. While this information is believed to be accurate, Schneider Electric reserves the right to make updates and changes without prior notification and assumes no liability for any errors or omissions.

Harmony, Schneider Electric and logo are trademarks or registered trademarks of Schneider Electric or its affiliates in the United States and other countries. Other trademarks used herein are the property of their respective owners.

Design: Schneider Electric
Photos: Schneider Electric



2011

Harmony™ 9001K/SK/KX 30 mm push buttons



Стандарт Электрон Связь

Мы молодая и активно развивающаяся компания в области поставок электронных компонентов. Мы поставляем электронные компоненты отечественного и импортного производства напрямую от производителей и с крупнейших складов мира.

Благодаря сотрудничеству с мировыми поставщиками мы осуществляем комплексные и плановые поставки широчайшего спектра электронных компонентов.

Собственная эффективная логистика и склад в обеспечивает надежную поставку продукции в точно указанные сроки по всей России.

Мы осуществляем техническую поддержку нашим клиентам и предпродажную проверку качества продукции. На все поставляемые продукты мы предоставляем гарантию .

Осуществляем поставки продукции под контролем ВП МО РФ на предприятия военно-промышленного комплекса России , а также работаем в рамках 275 ФЗ с открытием отдельных счетов в уполномоченном банке. Система менеджмента качества компании соответствует требованиям ГОСТ ISO 9001.

Минимальные сроки поставки, гибкие цены, неограниченный ассортимент и индивидуальный подход к клиентам являются основой для выстраивания долгосрочного и эффективного сотрудничества с предприятиями радиоэлектронной промышленности, предприятиями ВПК и научно-исследовательскими институтами России.

С нами вы становитесь еще успешнее!

Наши контакты:

Телефон: +7 812 627 14 35

Электронная почта: sales@st-electron.ru

Адрес: 198099, Санкт-Петербург,
Промышленная ул, дом № 19, литера Н,
помещение 100-Н Офис 331