

RF Power GaN Transistor

This 125 W CW RF power transistor is optimized for wideband operation up to 2700 MHz and includes input matching for extended bandwidth performance. With its high gain and high ruggedness, this device is ideally suited for CW, pulse and wideband RF applications.

This part is characterized and performance is guaranteed for applications operating in the 1–2700 MHz band. There is no guarantee of performance when this part is used in applications designed outside of these frequencies.

Typical Narrowband Performance: $V_{DD} = 50$ Vdc, $I_{DQ} = 350$ mA, $T_A = 25^\circ\text{C}$

Frequency (MHz)	Signal Type	P_{out} (W)	G_{ps} (dB)	η_D (%)
2500 (1)	CW	125 CW	16.0	64.2
2500 (1)	Pulse (100 μsec , 20% Duty Cycle)	125 Peak	18.0	66.8

Typical Wideband Performance: $V_{DD} = 50$ Vdc, $T_A = 25^\circ\text{C}$

Frequency (MHz)	Signal Type	P_{out} (W)	G_{ps} (2) (dB)	η_D (2) (%)
200–2500 (3)	CW	100 CW	12.0	40.0
1300–1900 (4)	CW	125 CW	14.5	45.0

Load Mismatch/Ruggedness

Frequency (MHz)	Signal Type	VSWR	P_{in} (W)	Test Voltage	Result
2500 (1)	Pulse (100 μsec , 20% Duty Cycle)	> 20:1 at All Phase Angles	5.0 Peak (3 dB Overdrive)	50	No Device Degradation

1. Measured in 2500 MHz narrowband test circuit.
2. The values shown are the minimum measured performance numbers across the indicated frequency range.
3. Measured in 200–2500 MHz broadband reference circuit.
4. Measured in 1300–1900 MHz broadband reference circuit.

Features

- Advanced GaN on SiC, offering high power density
- Decade bandwidth performance
- Low thermal resistance
- Input matched for extended wideband performance
- High ruggedness: > 20:1 VSWR

Typical Applications

- Ideal for military end-use applications, including the following:
 - Narrowband and multi-octave wideband amplifiers
 - Radar
 - Jammers
 - EMC testing
- Also suitable for commercial applications, including the following:
 - Public mobile radios, including emergency service radios
 - Industrial, scientific and medical
 - Wideband laboratory amplifiers
 - Wireless cellular infrastructure

MMRF5014H

**1–2700 MHz, 125 W CW, 50 V
WIDEBAND
RF POWER GaN TRANSISTOR**



NI-360H-2SB

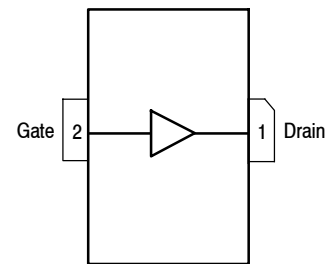

(Top View)

Note: The backside of the package is the source terminal for the transistor.

Figure 1. Pin Connections

Table 1. Maximum Ratings

Rating	Symbol	Value	Unit
Drain-Source Voltage	V_{DSS}	125	Vdc
Gate-Source Voltage	V_{GS}	-8, 0	Vdc
Operating Voltage	V_{DD}	0 to +50	Vdc
Maximum Forward Gate Current @ $T_C = 25^\circ\text{C}$	I_{GMAX}	18	mA
Storage Temperature Range	T_{stg}	-65 to +150	$^\circ\text{C}$
Case Operating Temperature Range	T_C	-55 to +150	$^\circ\text{C}$
Operating Junction Temperature Range	T_J	-55 to +225	$^\circ\text{C}$
Absolute Maximum Channel Temperature (1)	T_{MAX}	350	$^\circ\text{C}$
Total Device Dissipation @ $T_C = 25^\circ\text{C}$ Derate above 25°C	P_D	232 1.16	W W/ $^\circ\text{C}$

Table 2. Thermal Characteristics

Characteristic	Symbol	Value	Unit
Thermal Resistance by Infrared Measurement, Active Die Surface-to-Case CW: Case Temperature 82°C , 125 W CW, 50 Vdc, $I_{DQ} = 350$ mA, 2500 MHz	$R_{\theta JC}$ (IR)	0.86 (2)	$^\circ\text{C}/\text{W}$
Thermal Resistance by Finite Element Analysis, Channel-to-Case Case Temperature 85°C , $P_D = 85$ W	$R_{\theta CHC}$ (FEA)	1.48 (3)	$^\circ\text{C}/\text{W}$
Thermal Impedance by Infrared Measurement, Junction-to-Case Pulse: Case Temperature 58°C , 125 W Peak, 100 μsec Pulse Width, 20% Duty Cycle, 50 Vdc, $I_{DQ} = 350$ mA, 2500 MHz	$Z_{\theta JC}$ (IR)	0.21	$^\circ\text{C}/\text{W}$

Table 3. ESD Protection Characteristics

Test Methodology	Class
Human Body Model (per JESD22-A114)	1B, passes 500 V
Machine Model (per EIA/JESD22-A115)	A, passes 100 V
Charge Device Model (per JESD22-C101)	IV, passes 2000 V

Table 4. Electrical Characteristics ($T_A = 25^\circ\text{C}$ unless otherwise noted)

Characteristic	Symbol	Min	Typ	Max	Unit
Off Characteristics					
Drain Leakage Current ($V_{GS} = -8$ Vdc, $V_{DS} = 10$ Vdc)	I_{DSS}	—	—	5	mAdc
Drain-Source Breakdown Voltage ($V_{GS} = -8$ Vdc, $I_D = 25$ mAdc)	$V_{(BR)DSS}$	150	—	—	Vdc
On Characteristics					
Gate Threshold Voltage ($V_{DS} = 10$ Vdc, $I_D = 25$ mAdc)	$V_{GS(th)}$	-3.8	-2.9	-2.3	Vdc
Gate Quiescent Voltage ($V_{DS} = 50$ Vdc, $I_D = 350$ mAdc, Measured in Functional Test)	$V_{GS(Q)}$	-3.2	-2.7	-2.2	Vdc
Dynamic Characteristics					
Reverse Transfer Capacitance ($V_{DS} = 50$ Vdc \pm 30 mV(rms)ac @ 1 MHz, $V_{GS} = -4$ Vdc)	C_{rss}	—	1.0	—	pF
Output Capacitance ($V_{DS} = 50$ Vdc \pm 30 mV(rms)ac @ 1 MHz, $V_{GS} = -4$ Vdc)	C_{oss}	—	7.7	—	pF
Input Capacitance (4) ($V_{DS} = 50$ Vdc, $V_{GS} = -4$ Vdc \pm 30 mV(rms)ac @ 1 MHz)	C_{iss}	—	51.0	—	pF

- Reliability tests were conducted at 225°C . Operation with T_{MAX} at 350°C will reduce median time to failure.
- Refer to AN1955, *Thermal Measurement Methodology of RF Power Amplifiers*. Go to <http://www.nxp.com/RF> and search for AN1955.
- $R_{\theta JC}$ (FEA) must be used for purposes related to reliability and limitations on maximum junction temperature. MTTF may be estimated by the expression $MTTF$ (hours) = $10^{[A + B/(T + 273)]}$, where T is the junction temperature in degrees Celsius, $A = -8.44$ and $B = 7210$.
- Part internally input matched.

(continued)

Table 4. Electrical Characteristics ($T_A = 25^\circ\text{C}$ unless otherwise noted) (continued)

Characteristic	Symbol	Min	Typ	Max	Unit
Functional Tests (In NXP Test Fixture, 50 ohm system) $V_{DD} = 50\text{ Vdc}$, $I_{DQ} = 350\text{ mA}$, $P_{out} = 125\text{ W Peak}$ (25 W Avg.), $f = 2500\text{ MHz}$, 100 μsec Pulse Width, 20% Duty Cycle. [See note on correct biasing sequence.]					
Power Gain	G_{ps}	17.0	18.0	20.0	dB
Drain Efficiency	η_D	64.3	66.8	—	%
Input Return Loss	IRL	—	-12	-9	dB

Load Mismatch/Ruggedness (In NXP Test Fixture, 50 ohm system) $I_{DQ} = 350\text{ mA}$

Frequency (MHz)	Signal Type	VSWR	P_{in} (W)	Test Voltage, V_{DD}	Result
2500	Pulse (100 μsec , 20% Duty Cycle)	> 20:1 at All Phase Angles	5.0 Peak (3 dB Overdrive)	50	No Device Degradation

Table 5. Ordering Information

Device	Tape and Reel Information	Package
MMRF5014HR5	R5 Suffix = 50 Units, 32 mm Tape Width, 13-inch Reel	NI-360H-2SB

NOTE: Correct Biasing Sequence for GaN Depletion Mode Transistors**Turning the device ON**

1. Set V_{GS} to -5 V
2. Turn on V_{DS} to nominal supply voltage (50 V)
3. Increase V_{GS} until I_{DS} current is attained
4. Apply RF input power to desired level

Turning the device OFF

1. Turn RF power off
2. Reduce V_{GS} down to -5 V
3. Reduce V_{DS} down to 0 V (Adequate time must be allowed for V_{DS} to reduce to 0 V to prevent severe damage to device.)
4. Turn off V_{GS}

500–2500 MHz WIDEBAND REFERENCE CIRCUIT — 2.0" x 4.0" (5.1 cm x 10.2 cm)

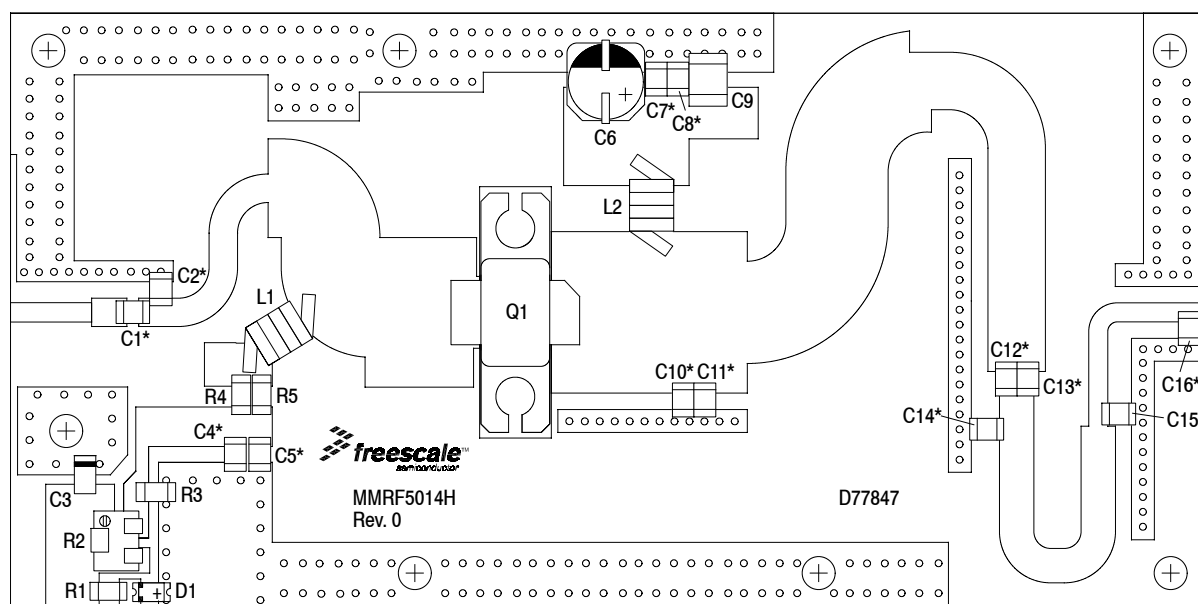

*C1, C2, C4, C5, C7, C8, C10, C11, C12, C13, C14, C15 and C16 are mounted vertically.

Figure 2. MMRF5014H Wideband Reference Circuit Component Layout — 500–2500 MHz

Table 6. MMRF5014H Wideband Reference Circuit Component Designations and Values — 500–2500 MHz

Part	Description	Part Number	Manufacturer
C1, C5, C7	33 pF Chip Capacitors	ATC800B330JT500XT	ATC
C2	0.4 pF Chip Capacitor	ATC800B0R4BT500XT	ATC
C3	2.2 μ F, 16 V Tantalum Capacitor	T491A225K016AT	Kemet
C4, C8	1000 pF Chip Capacitors	ATC800B102JT50XT	ATC
C6	220 μ F, 50 V Electrolytic Capacitor	EEV-HA1H221P	Panasonic-ECG
C9	2.2 μ F Chip Capacitor	HMK432B7225KM-T	Taiyo Yuden
C10, C11	0.8 pF Chip Capacitors	ATC800B0R8BT500XT	ATC
C12, C13	9.1 pF Chip Capacitors	ATC800B9R1BT500XT	ATC
C14, C16	0.5 pF Chip Capacitors	ATC800B0R5BT500XT	ATC
C15	0.2 pF Chip Capacitor	ATC800B0R2BT500XT	ATC
D1	LED Green Diffused 1206, SMD	LGN971-KN-1	OSRAM
L1	33 nH Inductor	1812SMS-33NJLC	Coilcraft
L2	17.5 nH Inductor, 5 Turns	GA3095-ALC	Coilcraft
Q1	RF Power GaN Transistor	MMRF5014H	NXP
R1	75 Ω , 1/4 W Chip Resistor	CRCW120675R0FKEA	Vishay
R2	500 Ω Trimming Potentiometer, 11 Turns	3224W-1-501E	Bourns
R3	470 Ω , 1/4 W Chip Resistor	CRCW1206470RFKEA	Vishay
R4, R5	39 Ω , 1/4 W Chip Resistors	CRCW120639R0FKEA	Vishay
PCB	Rogers RO4350B 0.030", $\epsilon_r = 3.66$	D77847	MTL

Note: Refer to MMRF5014H's printed circuit boards and schematics to download the 500–2500 MHz heatsink drawing.

TYPICAL CHARACTERISTICS — 500–2500 MHz
WIDEBAND REFERENCE CIRCUIT

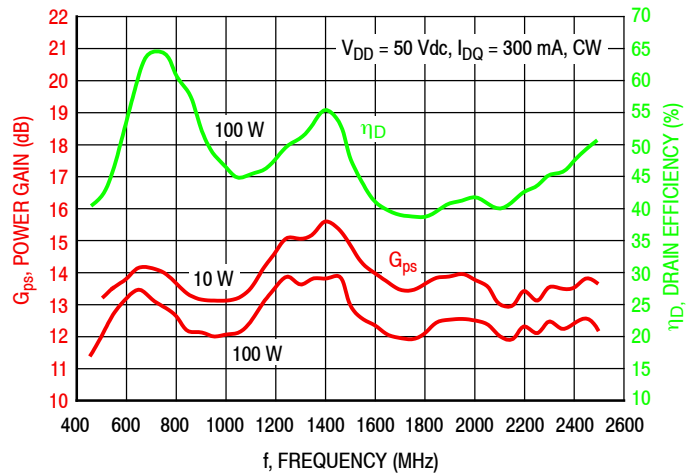

Figure 3. 500–2500 MHz Wideband Circuit Performance

200–2500 MHz WIDEBAND REFERENCE CIRCUIT — 4.0" x 5.0" (10.2 cm x 12.7 cm)

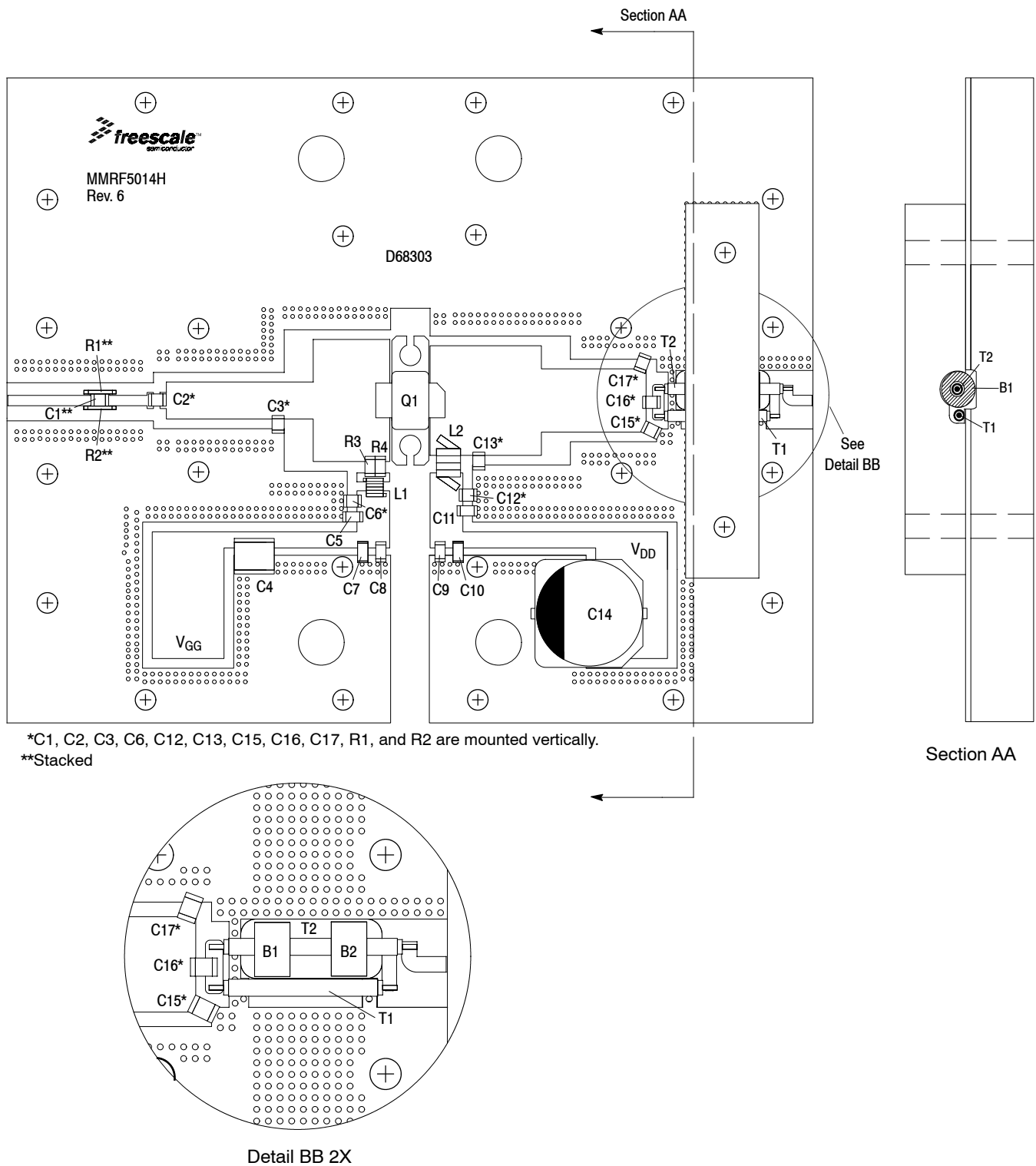

Figure 4. MMRF5014H Wideband Reference Circuit Component Layout — 200–2500 MHz

Table 7. MMRF5014H Wideband Reference Circuit Component Designations and Values — 200–2500 MHz

Part	Description	Part Number	Manufacturer
B1, B2	Ferrite Beads	T22-6	Micro Metals
C1	56 pF Chip Capacitor	ATC800B560JT500XT	ATC
C2	75 pF Chip Capacitor	ATC800B750JT500XT	ATC
C3	1.6 pF Chip Capacitor	ATC800B1R6BT500XT	ATC
C4	6.8 μ F Chip Capacitor	C4532X7R1H685K	TDK
C5, C8, C9, C11	0.015 μ F Chip Capacitors	GRM319R72A153KA01D	Murata
C6, C12	5.6 pF Chip Capacitors	ATC800B5R6BT500XT	ATC
C7, C10	1 μ F Chip Capacitors	GRM31CR72A105KAO1L	Murata
C13	1.4 pF Chip Capacitor	ATC800B1R4BT500XT	ATC
C14	220 μ F, 100 V Electrolytic Capacitor	EEV-FK2A221M	Panasonic-ECG
C15, C17	0.9 pF Chip Capacitors	ATC800B0R9BT500XT	ATC
C16	47 pF Chip Capacitor	ATC800B470JT500XT	ATC
L1	12.5 nH Inductor, 4 Turns	A04TJLC	Coilcraft
L2	22 nH Inductor	1812SMS-22NJLC	Coilcraft
Q1	RF Power GaN Transistor	MMRF5014H	NXP
R1, R2	10 Ω , 3/4 W Chip Resistors	CRCW201010R0FKEF	Vishay
R3, R4	39 Ω , 1/4 W Chip Resistors	CRCW120639R0FKEA	Vishay
T1	25 Ω Semi Rigid Coax, 0.770" Shield Length	UT-070-25	Micro-Coax
T2	25 Ω Semi Rigid Coax, 0.850" Shield Length	UT-070-25	Micro-Coax
PCB	Rogers RO4350B, 0.030", $\epsilon_r = 3.66$	D68303	MTL

Note: Refer to MMRF5014H's printed circuit boards and schematics to download the 200–2500 MHz heatsink drawing.

**TYPICAL CHARACTERISTICS — 200–2500 MHz
WIDEBAND REFERENCE CIRCUIT**

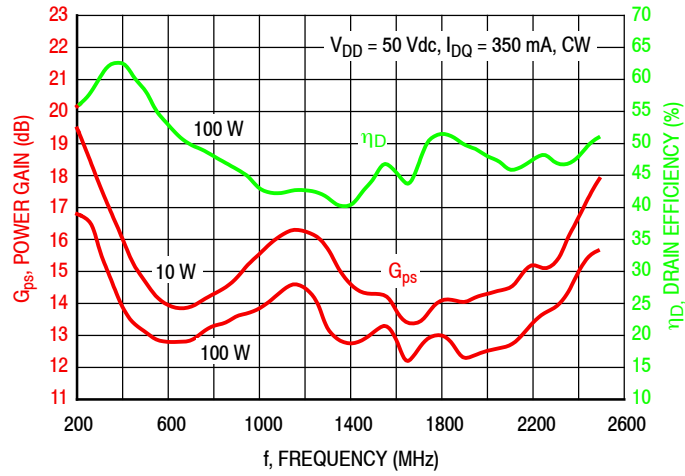

Figure 5. 200–2500 MHz Wideband Circuit Performance

TYPICAL CHARACTERISTICS — OPTIMIZED NARROWBAND PERFORMANCE

Narrowband Performance and Impedance Information ($T_C = 25^\circ\text{C}$)

The measured input and output impedances are presented to the input of the device at the package reference plane. Measurements are performed in NXP narrowband fixture tuned at 500, 1000, 1500, 2000 and 2500 MHz.

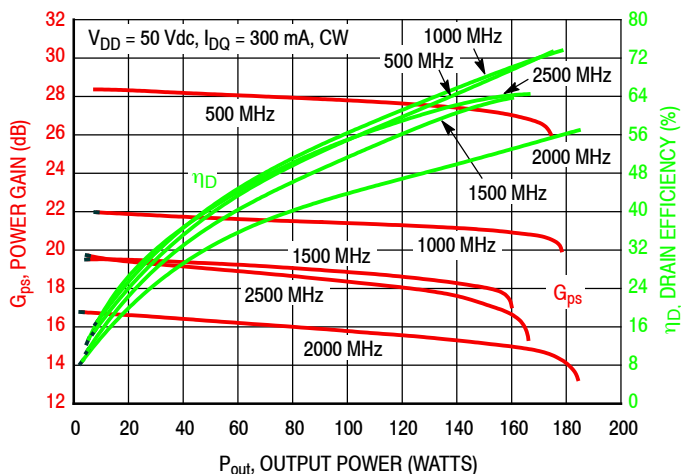

Figure 6. Power Gain and Drain Efficiency versus CW Output Power

f MHz	Z _{source} Ω	Z _{load} Ω
500	1.3 + j3.9	5.9 + j3.5
1000	1.0 + j0.3	5.5 + j2.9
1500	0.8 - j0.5	3.4 + j2.0
2000	1.2 - j2.0	4.7 + j0.3
2500	2.7 - j3.8	3.7 + j1.4

Z_{source} = Test circuit impedance as measured from gate to ground.

Z_{load} = Test circuit impedance as measured from drain to ground.

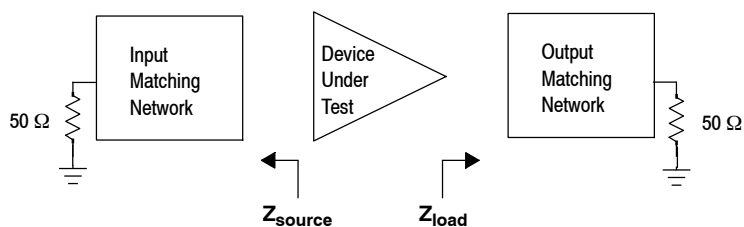
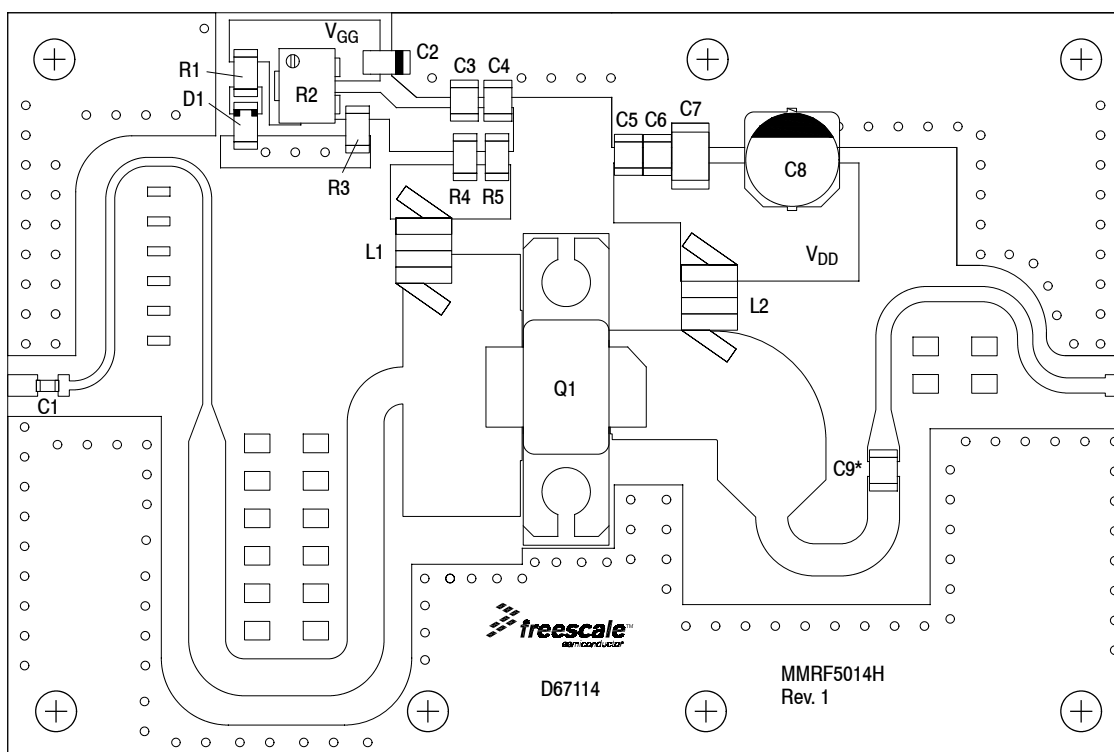

Figure 7. Narrowband Fixtures: Series Equivalent Source and Load Impedances

1300–1900 MHz WIDEBAND REFERENCE CIRCUIT — 2.0" x 3.0" (5.1 cm x 7.6 cm)



*C9 is mounted vertically.

Figure 8. MMRF5014H Wideband Reference Circuit Component Layout — 1300–1900 MHz

Table 8. MMRF5014H Wideband Reference Circuit Component Designations and Values — 1300–1900 MHz

Part	Description	Part Number	Manufacturer
C1	18 pF Chip Capacitor	ATC600S180CT250XT	ATC
C2	2.2 μ F Tantalum Capacitor	T491A225K016AT	Kemet
C3, C6	1000 pF Chip Capacitors	ATC800B102JT50XT	ATC
C4, C5	33 pF Chip Capacitors	ATC800B330JT500XT	ATC
C7	2.2 μ F Chip Capacitor	HMK432B7225KM-T	Taiyo Tuden
C8	47 μ F, 100 V Electrolytic Capacitor	476KXM050M	Panasonic-ECG
C9	9.1 pF Chip Capacitor	ATC800B9R1BT500XT	ATC
D1	LED Green Diffused 1206, SMD	LGN971-KN-1	OSRAM
Q1	RF Power GaN Transistor	MMRF5014H	NXP
R1	75 Ω , 1/4 W Chip Resistor	CRCW120675R0FKEA	Vishay
R2	5 k Ω Trimming Potentiometer, 11 Turns	3224W-1-502E	Bourns
R3	5 k Ω , 1/4 W Chip Resistor	CRCW12065K00FKEA	Vishay
R4, R5	39 Ω , 1/4 W Chip Resistors	CRCW120639R0FKEA	Vishay
L1, L2	33 nH Inductors	1812SMS-33NJLC	Coilcraft
PCB	Rogers 3010, 0.025", $\epsilon_r = 10.2$	D67114	MTL

**TYPICAL CHARACTERISTICS — 1300–1900 MHz
WIDEBAND REFERENCE CIRCUIT**

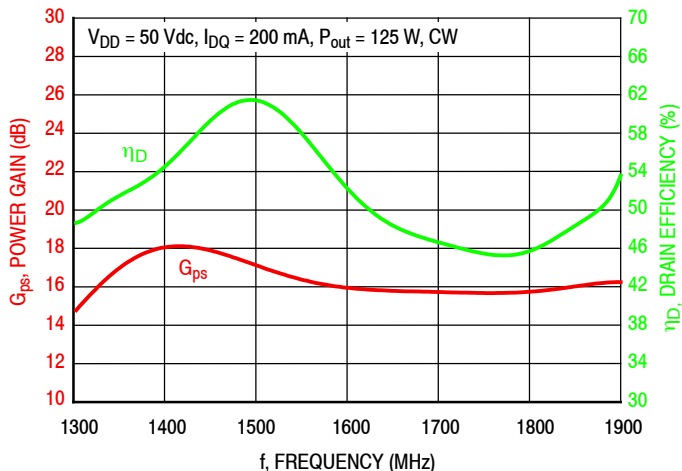

Figure 9. Power Gain and Drain Efficiency versus Frequency

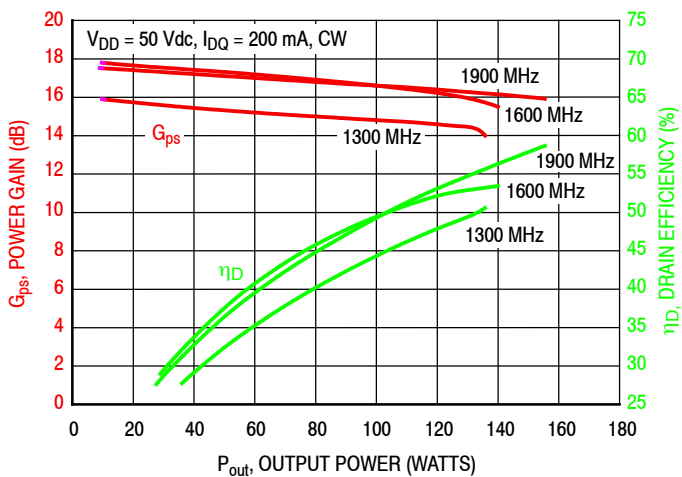

Figure 10. Power Gain and Drain Efficiency versus CW Output Power

2500 MHz NARROWBAND PRODUCTION TEST FIXTURE — 4.0" x 5.0" (10.2 cm x 12.7 cm)

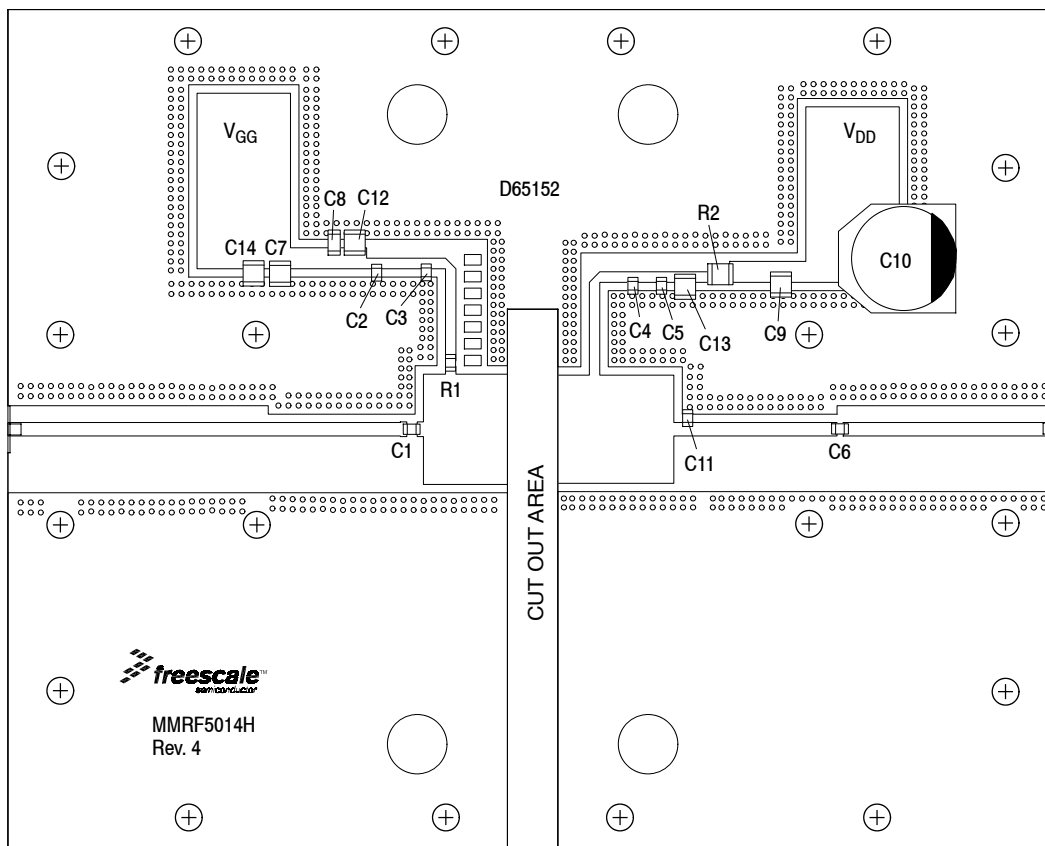

Figure 11. MMRF5014H Narrowband Test Circuit Component Layout — 2500 MHz

Table 9. MMRF5014H Narrowband Test Circuit Component Designations and Values — 2500 MHz

Part	Description	Part Number	Manufacturer
C1	3.9 pF Chip Capacitor	ATC600F3R9BT250XT	ATC
C2, C3, C4, C5, C6	12 pF Chip Capacitors	ATC600F120JT250XT	ATC
C7, C14	4.7 μ F Chip Capacitors	C4532X7R1H475K200KB	TDK
C8	0.1 μ F Chip Capacitor	GRM319R72A104KA01D	Murata
C9	1.0 μ F Chip Capacitor	GRM32CR72A105KA35L	Murata
C10	220 μ F, 100 V Electrolytic Capacitor	EEV-FK2A221M	Panasonic-ECG
C11	1 pF Chip Capacitor	ATC600F1R0BT250XT	ATC
C12, C13	1000 pF Chip Capacitors	ATC800B102JT50XT	ATC
R1	56 Ω , 1/4 W Chip Resistor	CRCW120656R0FKEA	Vishay
R2	0 Ω , 5 A Chip Resistor	CRCW12100000Z0EA	Vishay
PCB	Rogers RO4350B, 0.030", $\epsilon_r = 3.66$	D65152	MTL

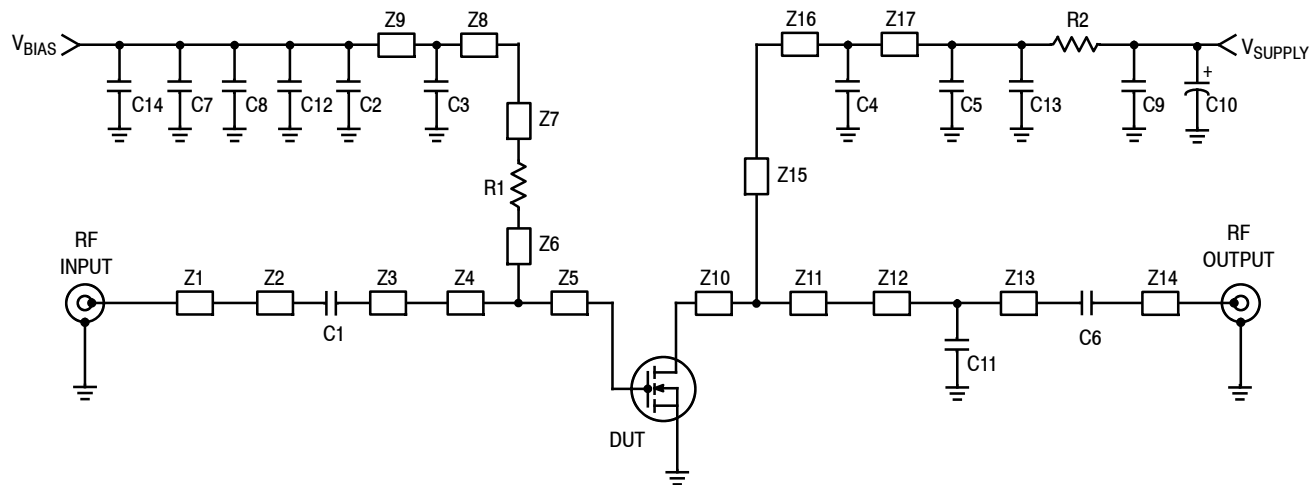

Figure 12. MMRF5014H Narrowband Test Circuit Schematic — 2500 MHz

Table 10. MMRF5014H Narrowband Test Circuit Microstrips — 2500 MHz

Microstrip	Description	Microstrip	Description
Z1	1.870" × 0.064" Microstrip	Z10	0.145" × 0.515" Microstrip
Z2, Z3	0.030" × 0.070" Microstrip	Z11	0.353" × 0.515" Microstrip
Z4	0.105" × 0.525" Microstrip	Z12	0.040" × 0.064" Microstrip
Z5*	0.240" × 0.525" Microstrip	Z13	0.687" × 0.064" Microstrip
Z6	0.037" × 0.050" Microstrip	Z14	1.020" × 0.064" Microstrip
Z7	0.465" × 0.050" Microstrip	Z15	0.468" × 0.050" Microstrip
Z8	0.090" × 0.050" Microstrip	Z16	0.158" × 0.050" Microstrip
Z9	0.190" × 0.050" Microstrip	Z17	0.078" × 0.050" Microstrip

* Line length include microstrip bends

TYPICAL CHARACTERISTICS — 2500 MHz

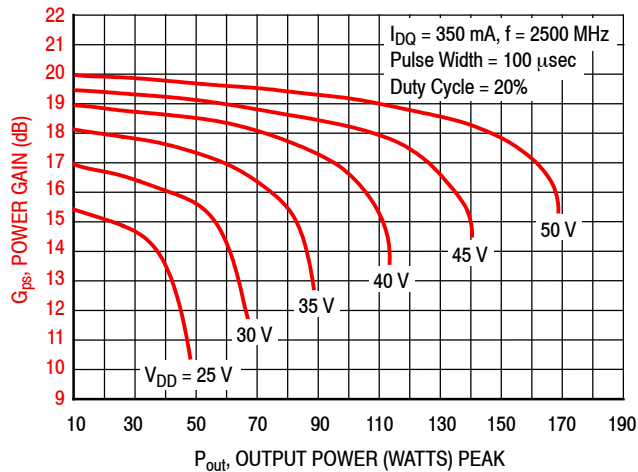

Figure 13. Power Gain versus Output Power and Drain Voltage (1)

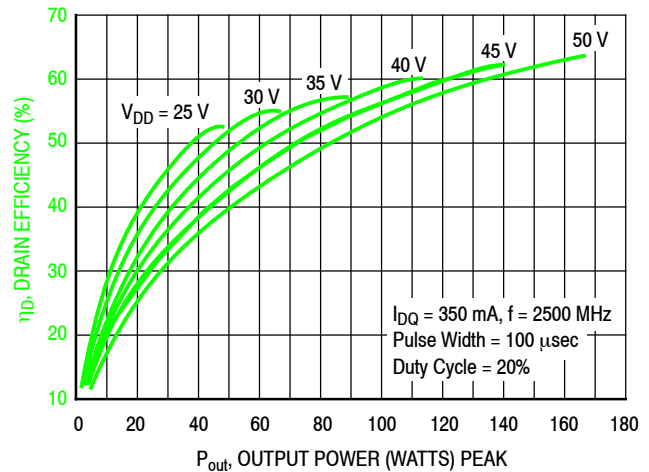

Figure 14. Drain Efficiency versus Output Power and Drain Voltage (1)

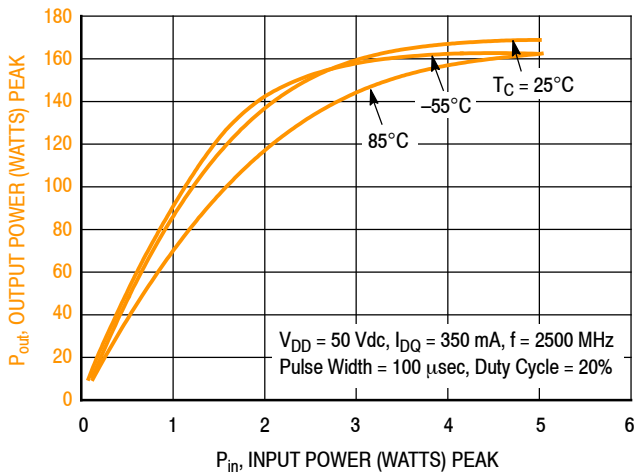

Figure 15. Output Power versus Input Power (1)

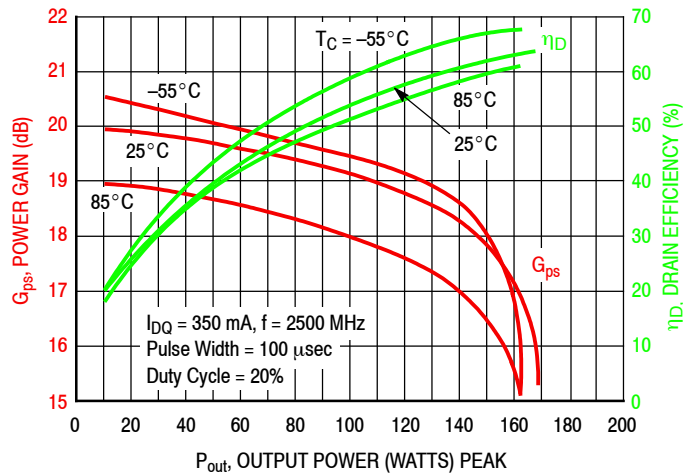
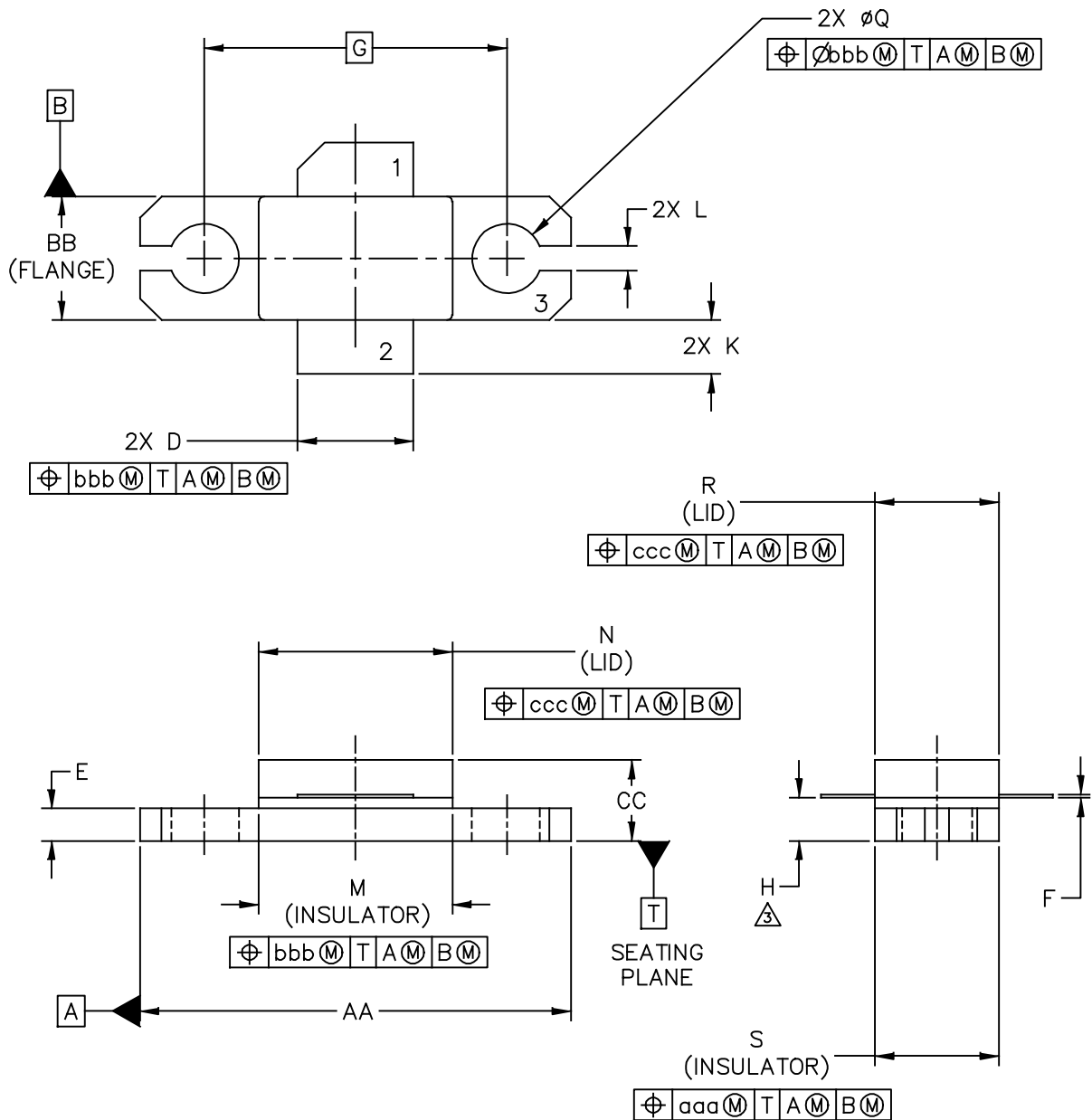

Figure 16. Power Gain and Drain Efficiency versus Output Power (1)

1. Circuit tuned for maximum power.

PACKAGE DIMENSIONS



© NXP SEMICONDUCTORS N.V. ALL RIGHTS RESERVED	MECHANICAL OUTLINE	PRINT VERSION NOT TO SCALE
TITLE: <div style="text-align: center; font-size: 1.2em;">NI-360H-2SB</div>	DOCUMENT NO: 98ASA00795D REV: A	
	STANDARD: NON-JEDEC	
	SOT1791-1 17 FEB 2016	

- Pin 1. Drain
- 2. Gate
- 3. Source

MMRF5014H

NOTES:

1. INTERPRET DIMENSIONS AND TOLERANCES PER ASME Y14.5M-1994.
2. CONTROLLING DIMENSION: INCH

3. DIMENSION H IS MEASURED .030 INCH (0.762 MM) AWAY FROM THE FLANGE TO CLEAR THE EPOXY FLOW OUT REGION PARALLEL TO DATUM B.

DIM	INCH		MILLIMETER		DIM	INCH		MILLIMETER	
	MIN	MAX	MIN	MAX		MIN	MAX	MIN	MAX
AA	.795	.805	20.19	20.45	N	.357	.363	9.07	9.22
BB	.225	.235	5.72	5.97	Q	.125	.135	3.18	3.43
CC	.125	.175	3.18	4.45	R	.227	.233	5.77	5.92
D	.210	.220	5.33	5.59	S	.225	.235	5.72	5.97
E	.055	.065	1.40	1.65					
F	.004	.006	0.10	0.15	aaa		.005		0.13
G	.562 BSC		14.28 BSC		bbb		.010		0.25
H	.077	.087	1.96	2.21	ccc		.015		0.38
K	.085	.115	2.16	2.92					
L	.040	.050	1.02	1.27					
M	.355	.365	9.02	9.27					
© NXP SEMICONDUCTORS N.V. ALL RIGHTS RESERVED			MECHANICAL OUTLINE			PRINT VERSION NOT TO SCALE			
TITLE: NI-360H-2SB					DOCUMENT NO: 98ASA00795D		REV: A		
					STANDARD: NON-JEDEC				
					SOT1791-1		17 FEB 2016		

PRODUCT DOCUMENTATION AND TOOLS

Refer to the following resources to aid your design process.

Application Notes

- AN1955: Thermal Measurement Methodology of RF Power Amplifiers

Development Tools

- Printed Circuit Boards

To Download Resources Specific to a Given Part Number:

1. Go to <http://www.nxp.com/RF>
2. Search by part number
3. Click part number link
4. Choose the desired resource from the drop down menu

REVISION HISTORY

The following table summarizes revisions to this document.

Revision	Date	Description
0	May 2015	• Initial Release of Data Sheet
1	Sept. 2015	• Table 1, Maximum Ratings: added Maximum Forward Gate Current, p. 2 • Table 4, Electrical Characteristics: changed Load Mismatch/Ruggedness signal type to pulse to reflect correct modulation signal, p. 3
2	Apr. 2017	• Biasing sequence for GaN depletion mode transistors: revised note to clarify correct biasing sequence for GaN parts, p. 3 • 500–2500 MHz wideband reference circuit: added performance data and graph, reference circuit component layout and component designations, pp. 4–5
3	May 2018	• Table 2, Thermal Characteristics: updated to include $R_{\theta CHC}$ (FEA) data, p. 2

How to Reach Us:

Home Page:
nxp.com

Web Support:
nxp.com/support

Information in this document is provided solely to enable system and software implementers to use NXP products. There are no express or implied copyright licenses granted hereunder to design or fabricate any integrated circuits based on the information in this document. NXP reserves the right to make changes without further notice to any products herein.

NXP makes no warranty, representation, or guarantee regarding the suitability of its products for any particular purpose, nor does NXP assume any liability arising out of the application or use of any product or circuit, and specifically disclaims any and all liability, including without limitation consequential or incidental damages. "Typical" parameters that may be provided in NXP data sheets and/or specifications can and do vary in different applications, and actual performance may vary over time. All operating parameters, including "typicals," must be validated for each customer application by customer's technical experts. NXP does not convey any license under its patent rights nor the rights of others. NXP sells products pursuant to standard terms and conditions of sale, which can be found at the following address: nxp.com/SalesTermsandConditions.

NXP, the NXP logo, Freescale, and the Freescale logo are trademarks of NXP B.V. All other product or service names are the property of their respective owners.
© 2015, 2017–2018 NXP B.V.





Стандарт Электрон Связь

Мы молодая и активно развивающаяся компания в области поставок электронных компонентов. Мы поставляем электронные компоненты отечественного и импортного производства напрямую от производителей и с крупнейших складов мира.

Благодаря сотрудничеству с мировыми поставщиками мы осуществляем комплексные и плановые поставки широчайшего спектра электронных компонентов.

Собственная эффективная логистика и склад в обеспечивает надежную поставку продукции в точно указанные сроки по всей России.

Мы осуществляем техническую поддержку нашим клиентам и предпродажную проверку качества продукции. На все поставляемые продукты мы предоставляем гарантию .

Осуществляем поставки продукции под контролем ВП МО РФ на предприятия военно-промышленного комплекса России , а также работаем в рамках 275 ФЗ с открытием отдельных счетов в уполномоченном банке. Система менеджмента качества компании соответствует требованиям ГОСТ ISO 9001.

Минимальные сроки поставки, гибкие цены, неограниченный ассортимент и индивидуальный подход к клиентам являются основой для выстраивания долгосрочного и эффективного сотрудничества с предприятиями радиоэлектронной промышленности, предприятиями ВПК и научно-исследовательскими институтами России.

С нами вы становитесь еще успешнее!

Наши контакты:

Телефон: +7 812 627 14 35

Электронная почта: sales@st-electron.ru

Адрес: 198099, Санкт-Петербург,
Промышленная ул, дом № 19, литера Н,
помещение 100-Н Офис 331