

μPG2185T6R-EVAL-A

Evaluation Board

- Description
- Insertion Loss of Through Board
- Performance Data Plots
- Assembly Drawing

Description:

The uPG2185T6R-EVAL-A evaluation board provides a quick and convenient means of evaluating the performance of the NEC uPG2185T6R switch. In addition to the device, the board provides DC block capacitors, power supply bypass capacitors, and RF and DC connectors.

A DC block capacitor is required at all RF ports. On this board, a 6pF capacitor is used for this purpose. The chosen capacitance value minimizes the mismatch effect associated with the serial capacitor over a relatively wide frequency range (2 to 6GHz). For a narrow band application or an application where the operating frequency is outside the specific frequency range, the user may select a different capacitance value. Generally the performance of the switch circuit is not sensitive, to a certain extent, to the value of DC block capacitors.

A 1000pF capacitor is used for DC bypass on all control lines. For high speed applications the user may choose smaller capacitance or no capacitor at all.

DC supply connectors:

P1 is control voltage V_{cont1} , P2 is V_{cont2} and pins P3 and P4 are the ground. V_{cont1} and V_{cont2} should be connected to separate power supplies to provide the required control logic.

RF connectors:

As indicated on the board, J1 is connected to the OUTPUT1 port, J2 is connected to the OUTPUT2 port and J3 is connected to the INPUT port.

Information on Board Material:

The board material is 20 mil thick Duroid 6002. Its dielectric constant is 2.94.

Switch Logic Table:

The following table lists the logic table for switch states.

Vcont1	Vcont2	INPUT – OUTPUT1	INPUT – OUTPUT2
H	L	OFF	ON
L	H	ON	OFF

Insertion Loss of Through Board:

The insertion loss plot shown below is from direct measurement on an evaluation board. It is necessary to take the loss through the connectors and PCB trace into account in assessing the insertion loss through the switch alone. To this end a through board was characterized to determine the board/connector loss. The table below lists the board loss at different frequencies.

INPUT FREQUENCY (GHz)	BOARD LOSS (dB)
2.4	0.14
2.5	0.15
4.9	0.20
6.0	0.26

Performance Plots:

The following plots show typical data on insertion loss, isolation and return losses for the condition of INPUT to OUTPUT1 path being ON. The data for condition of INPUT to OUTPUT2 being ON is similar.

Insertion Loss and Isolation (Input-Output)

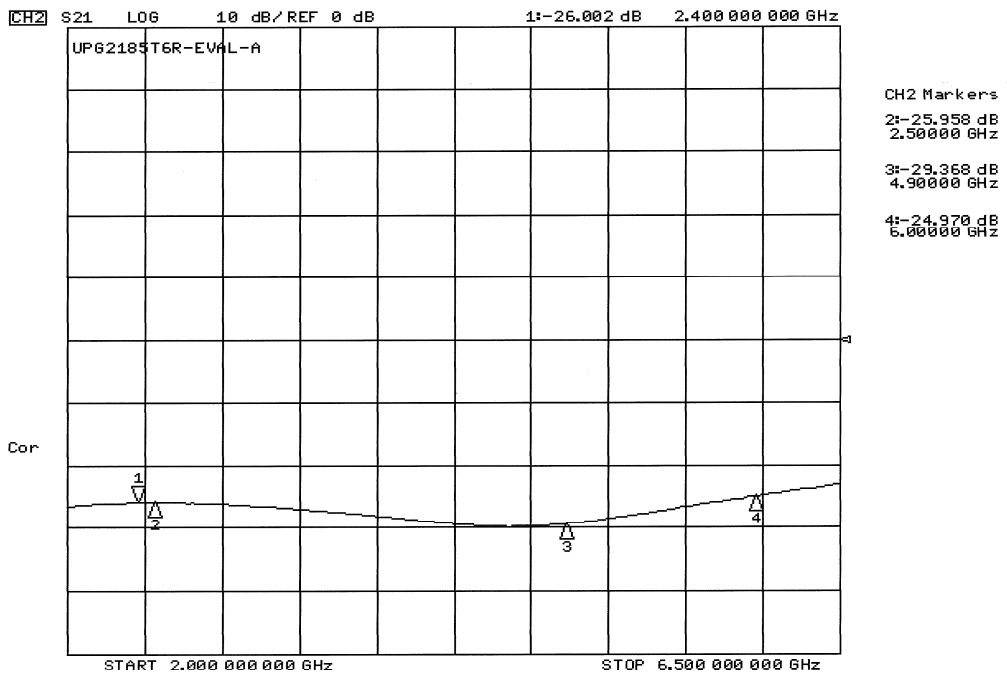
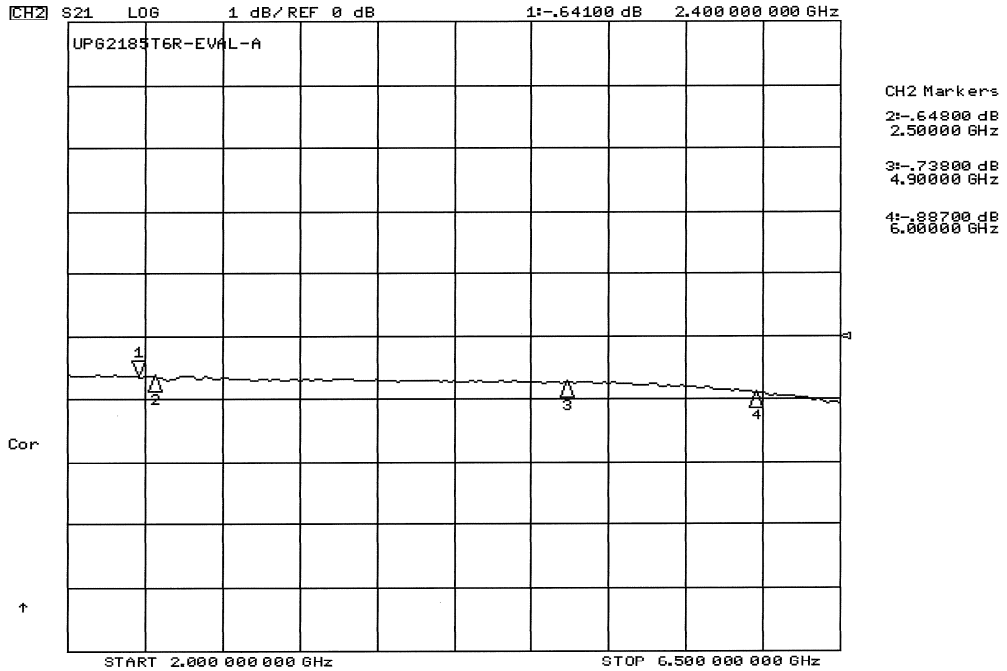

Input and Output Return Loss (Input-Output1)

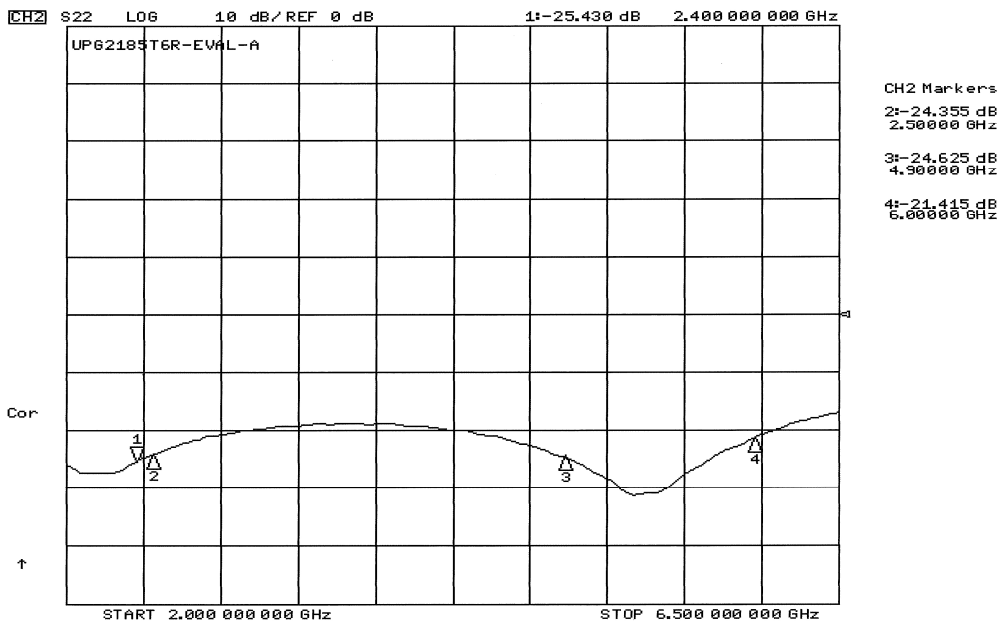
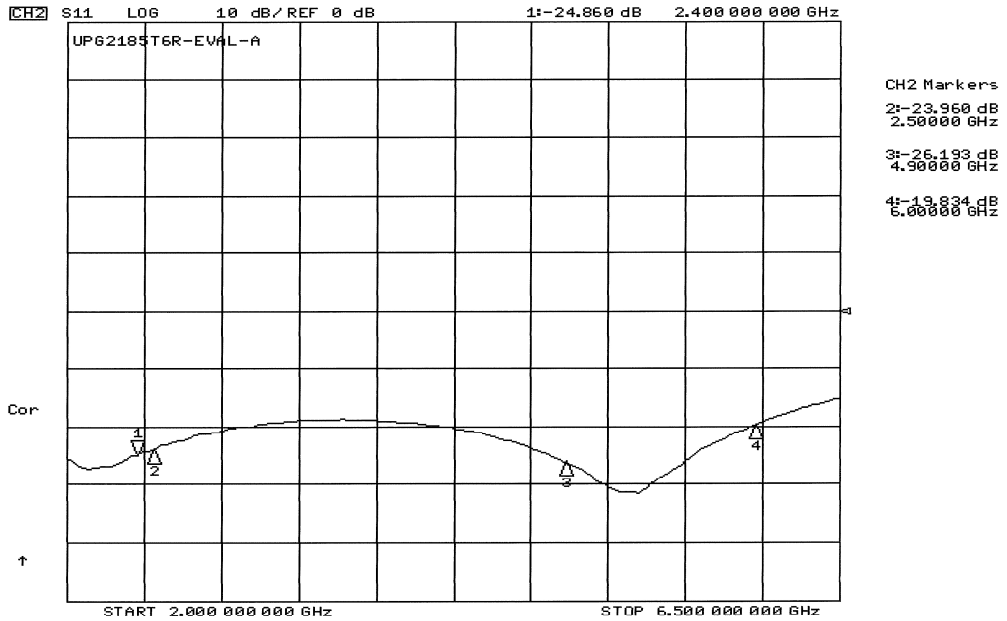

Isolation (Output1-Output2)

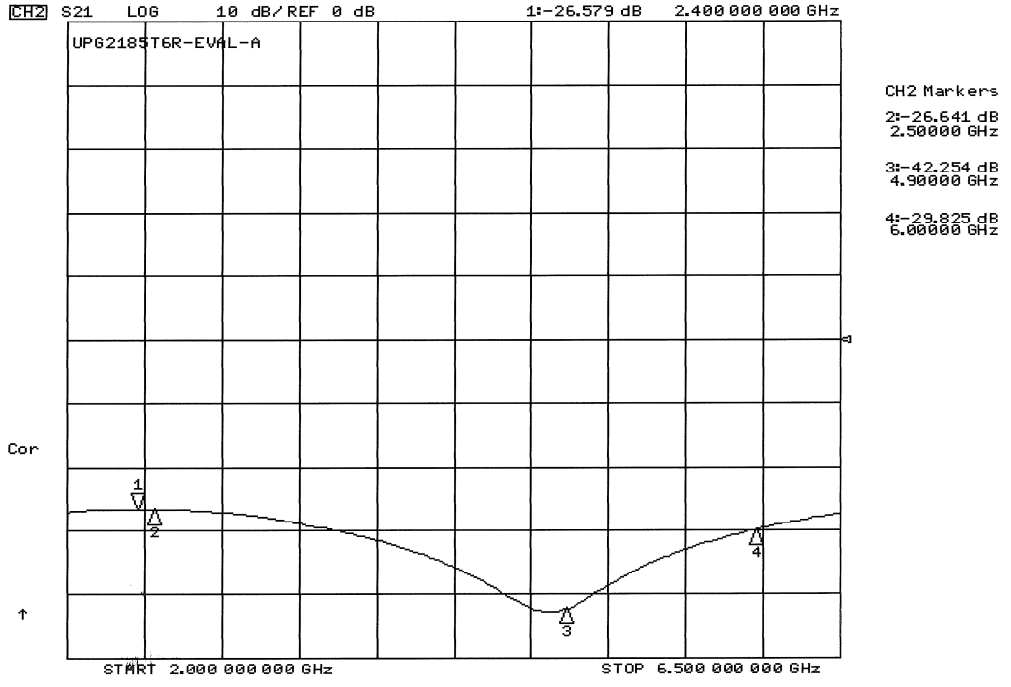

REVISIONS				
ZONE	LTR	DESCRIPTION	DATE	APPROVED

MARKING FOR PIN 1

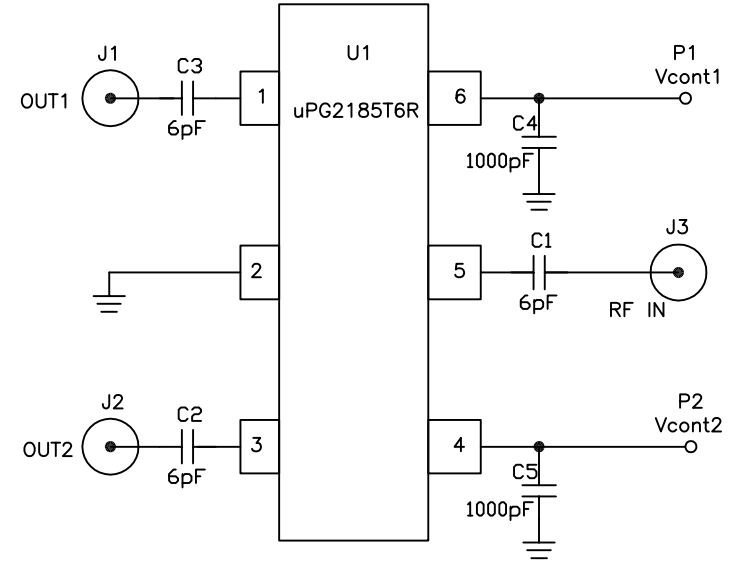
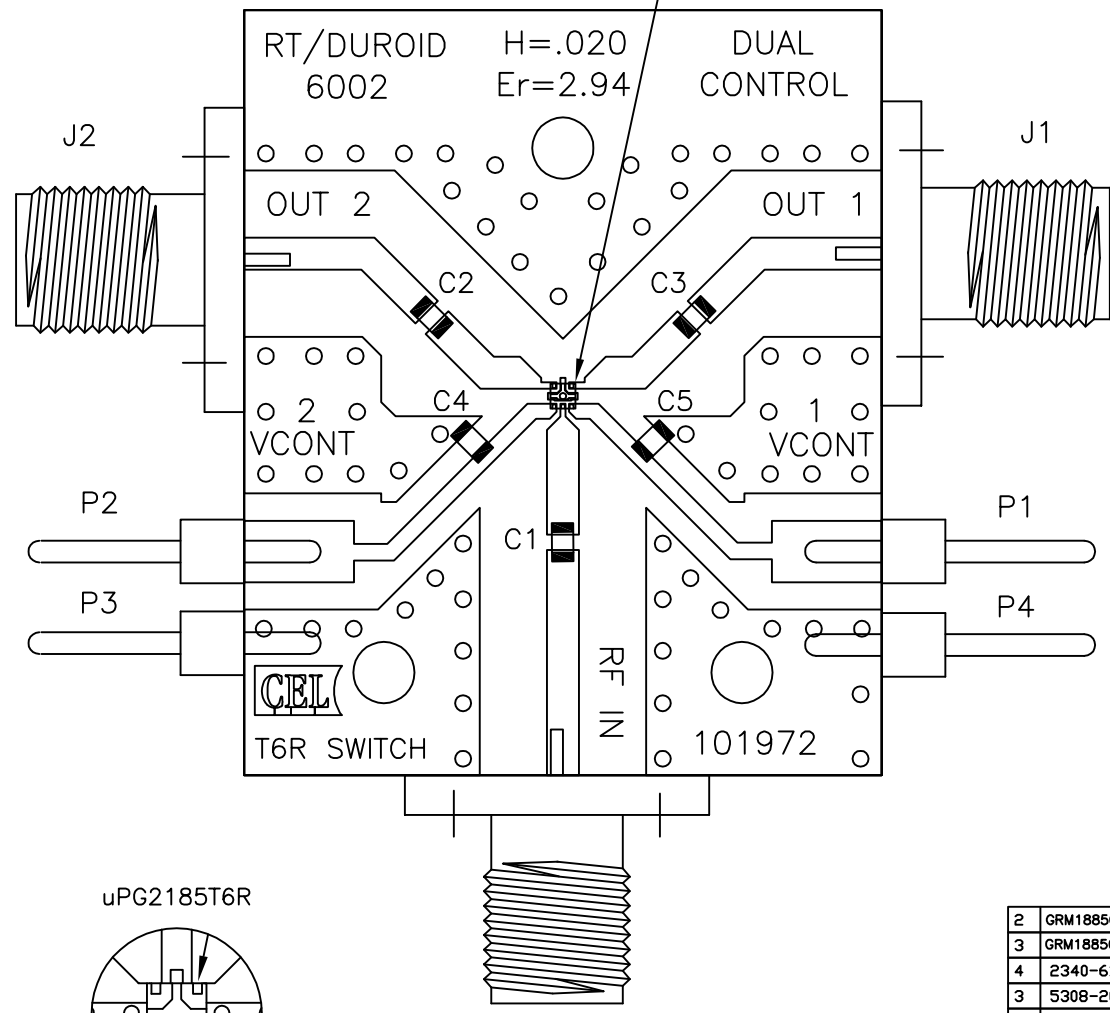

uPG2185T6R

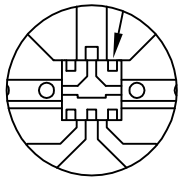

MARKING FOR PIN1 IS ON TOP OF CHIP
PACKAGE MARKING: G6

QTY	PART OR IDENTIFYING NO.	NOMENCLATURE OR DESCRIPTION	MATERIAL/SPECIFICATION	ITEM NO.
2	GRM1885C1H102JA01D	C4,C5	0603 1000pF CAP MURATA	6
3	GRM1885C1H6R0DZ01D	C1,C2,C3	0603 6pF CAP MURATA	5
4	2340-6111 TG	P1,P2,P3,P4	PIN HEADER 3M	4
3	5308-2CC	J1,J2,J3	SMA FEMALE CONNECTOR TENSOLITE	3
1	uPG2185T6R	U1	IC NEC uPG2185T6R GoAs Switch	2
1	CL-101972	DRAWING	COMPONENT LAYOUT DRAWING	1

UNLESS OTHERWISE SPECIFIED DIMENSIONS ARE IN INCHES TOLERANCES DECIMALS ANGULAR .XX± .XXTOL ± ANGLE .XXX± .XXXTOL DO NOT SCALE DRAWING		APPROVALS Drawing by: Bernard Urborg 03/27/2008 Designed by: Bernard Urborg 03/27/2008 Checked by: Project Engineer: Quality Control:		CEL CALIFORNIA EASTERN LABS 4590 PATRICK HENRY DR. SANTA CLARA CA. 95054 TITLE: UPG2185T6R-EVAL-A ASSEMBLY DRAWING	
MATERIAL MATL1STL MATL2NDL FINISH FINISH		SIZE FSCM NO. DWG NO. C AD101972		REV	
NEXT ASSY USED ON APPLICATION		SCALE RELEASE DATE RELDATE SHEET SHNO OF NOSH		REV	



Стандарт Электрон Связь

Мы молодая и активно развивающаяся компания в области поставок электронных компонентов. Мы поставляем электронные компоненты отечественного и импортного производства напрямую от производителей и с крупнейших складов мира.

Благодаря сотрудничеству с мировыми поставщиками мы осуществляем комплексные и плановые поставки широчайшего спектра электронных компонентов.

Собственная эффективная логистика и склад в обеспечивает надежную поставку продукции в точно указанные сроки по всей России.

Мы осуществляем техническую поддержку нашим клиентам и предпродажную проверку качества продукции. На все поставляемые продукты мы предоставляем гарантию .

Осуществляем поставки продукции под контролем ВП МО РФ на предприятия военно-промышленного комплекса России , а также работаем в рамках 275 ФЗ с открытием отдельных счетов в уполномоченном банке. Система менеджмента качества компании соответствует требованиям ГОСТ ISO 9001.

Минимальные сроки поставки, гибкие цены, неограниченный ассортимент и индивидуальный подход к клиентам являются основой для выстраивания долгосрочного и эффективного сотрудничества с предприятиями радиоэлектронной промышленности, предприятиями ВПК и научно-исследовательскими институтами России.

С нами вы становитесь еще успешнее!

Наши контакты:

Телефон: +7 812 627 14 35

Электронная почта: sales@st-electron.ru

Адрес: 198099, Санкт-Петербург,
Промышленная ул, дом № 19, литера Н,
помещение 100-Н Офис 331