

Compact Limit Switch That's Also Thin and Highly Sealed



- Approved by EN, UL, CSA, and CCC (Chinese standard). (Ask your OMRON representative for information on approved models.)
- Sealing characteristics that meet IEC IP67 degree of protection.
- Triple-sealed construction: Plunger section sealed via nitrile rubber packing seal and diaphragm; switch section sealed via nitrile rubber cap; cable entrance sealed via encapsulating material.
- Cable lengths of 3 and 5 m available on standard models. Models also available with UL and CSA-certified cables.
- Multiple mounting possible with Switches with Plungers.
- Models with red LED indicators added to series for easy confirmation of operation. (Set by default to light for non-operation.)
- VCTF cables with CE marking. (Applicable only to standard models.)



Be sure to read *Safety Precautions* on page 13 to 14 and *Safety Precautions for All Limit Switches*.

Model Number Structure

Model Number Legend (Not all combinations are possible. Ask your OMRON representative for details.)

Standard Models

D4C-□□□□
(1)(2)(3)

(1) Rated Current

- 1: 5 A at 250 VAC, 4 A at 30 VDC
- 2: 5 A at 125 VAC (with LED indicator)
- 3: 4 A 30 VDC (with LED indicator)
- 4: 0.1 A at 125 VAC, 0.1 A at 30 VDC
- 5: 0.1 A at 125 VAC (with LED indicator)
- 6: 0.1 A at 30 VDC (with LED indicator)

(2) Cable Specifications

- 2: VCTF oil-resistant cable (3 m)
- 3: VCTF oil-resistant cable (5 m)
- 4: VCTF (3 m)
- 5: VCTF (5 m)
- 6: SJT(O) (3 m)
- 7: SJT(O) (5 m)

(3) Actuator

- 01: Pin plunger
- 02: Roller plunger
- 03: Crossroller plunger
- 20: Roller lever
- 24: Roller lever (high-sensitivity model)
- 31: Sealed pin plunger
- 32: Sealed roller plunger
- 33: Sealed crossroller
- 50: Plastic rod
- 60: Center roller lever

Pre-wired Models

D4C-□0□□-□□□□□□
(1) (2) (3) (4)

(1) Rated Current

- 1: 1 A at 125 VAC, 1 A at 30 VDC (Without operation indicator)
- 2: 1 A at 125 VAC (with operation indicator)
- 3: 1 A at 30 VDC (with operation indicator)

(2) Actuator

- 01: Pin plunger
- 02: Roller plunger
- 31: Sealed plunger
- 32: Sealed roller plunger
- 24: Roller lever (high-sensitivity model)

(3) Wiring Specifications

- DK1EJ: Pre-wired models (3 conductors: DC specification)
 AK1EJ: Pre-wired models (3 conductors: AC specification)
 M1J: Connector models for ASI devices (2 conductors: NO wiring)

(4) Cable length

- 03: 0.3 m

Wiring Specifications

Internal switch	Connector
COM	3
NC	2
NO	4

Weather-resistant Models

D4C-□□□□-P
(1)(2)(3) (4)

(1) Rated Current

- 1: 5 A at 250 VAC, 4 A at 30 VDC
- 2: 5 A at 125 VAC (with LED indicator)
- 3: 4 A at 30 VDC (with LED indicator)
- 4: 0.1 A at 125 VAC, 0.1 A at 30 VDC

(2) Cable Specifications

- 2: VCTF oil-resistant cable (3 m)
- 3: VCTF oil-resistant cable (5 m)

(3) Actuator

- 20: Roller lever
- 24: Roller lever (high-sensitivity model)
- 27: Adjustable roller lever
- 29: Adjustable rod lever











(4) Structure

- P: Weather-resistant

Ordering Information

Switches

Switches with No Operation Indicator

Actuator	Ratings Cable Cable length (m)	Standard			Microload	
		5 A at 250 VAC, 4 A at 30 VDC			0.1 A at 125 VAC, 0.1 A at 30 VDC	
		VCTF oil-resistant cable *1	VCTF cable *2	SJT(O) cable *3	VCTF oil-resistant cable *1	VCTF cable *2
		Model				
Pin plunger 	3	D4C-1201	D4C-1401	D4C-1601	D4C-4201	D4C-4401
	5	D4C-1301	D4C-1501	D4C-1701	D4C-4301	D4C-4501
Roller plunger 	3	D4C-1202	D4C-1402	D4C-1602	D4C-4202	D4C-4402
	5	D4C-1302	D4C-1502	D4C-1702	D4C-4302	D4C-4502
Crossroller plunger 	3	D4C-1203	D4C-1403	D4C-1603	D4C-4203	D4C-4403
	5	D4C-1303	D4C-1503	D4C-1703	D4C-4303	D4C-4503
Roller lever 	3	D4C-1220	D4C-1420	D4C-1620	D4C-4220	D4C-4420
	5	D4C-1320	D4C-1520	D4C-1720	D4C-4320	D4C-4520
Roller lever, high-sensitivity 	3	D4C-1224	D4C-1424	D4C-1624	D4C-4224	D4C-4424
	5	D4C-1324	D4C-1524	D4C-1724	D4C-4324	D4C-4524
Sealed pin plunger 	3	D4C-1231	D4C-1431	D4C-1631	D4C-4231	D4C-4431
	5	D4C-1331	D4C-1531	D4C-1731	D4C-4331	D4C-4531
Sealed roller plunger 	3	D4C-1232	D4C-1432	D4C-1632	D4C-4232	D4C-4432
	5	D4C-1332	D4C-1532	D4C-1732	D4C-4332	D4C-4532
Sealed crossroller plunger 	3	D4C-1233	D4C-1433	D4C-1633	D4C-4233	D4C-4433
	5	D4C-1333	D4C-1533	D4C-1733	D4C-4333	D4C-4533
Plastic rod 	3	D4C-1250	D4C-1450	D4C-1650	D4C-4250	D4C-4450
	5	D4C-1350	D4C-1550	D4C-1750	D4C-4350	D4C-4550
Center roller lever 	3	D4C-1260	D4C-1460	D4C-1660	D4C-4260	D4C-4460
	5	D4C-1360	D4C-1560	---	D4C-4360	D4C-4560

Note: 1. Models are available separately with resistance to viscous oils (oil drain holes are also available), but only with Plunger Models. Add “-M” to the model number (example: D4C-1202 would be D4C-1202-M).

2. Switches with variable roller levers are also available. Ask your nearest OMRON representative for details.

*1. Oil-resistant vinyl cabtire cables; approved by EN and IEC.

*2. Ordinary vinyl cabtire cables; approved by EN and IEC.

*3. Switches with SJT(O) Cables (cables approved by UL and CSA) are approved by UL and CSA.

Standard Switches with Operation Indicator (Red)

Actuator	Ratings Cable Cable length (m)	0.1 A at 125 VAC		0.1 A at 30 VDC	
		VCTF oil-resistant cable *1	VCTF cable *2	VCTF oil-resistant cable *1	VCTF cable *2
		Model			
Pin plunger 	3	D4C-2201	D4C-2401	D4C-3201	D4C-3401
	5	D4C-2301	D4C-2501	D4C-3301	D4C-3501
Roller plunger 	3	D4C-2202	D4C-2402	D4C-3202	D4C-3402
	5	D4C-2302	D4C-2502	D4C-3302	D4C-3502
Crossroller plunger 	3	D4C-2203	D4C-2403	D4C-3203	D4C-3403
	5	D4C-2303	D4C-2503	D4C-3303	D4C-3503
Roller lever 	3	D4C-2220	D4C-2420	D4C-3220	D4C-3420
	5	D4C-2320	D4C-2520	D4C-3320	D4C-3520
Roller lever, high-sensitivity 	3	D4C-2224	D4C-2424	D4C-3224	D4C-3424
	5	D4C-2324	D4C-2524	D4C-3324	D4C-3524
Sealed pin plunger 	3	D4C-2231	D4C-2431	D4C-3231	D4C-3431
	5	D4C-2331	D4C-2531	D4C-3331	D4C-3531
Sealed roller plunger 	3	D4C-2232	D4C-2432	D4C-3232	D4C-3432
	5	D4C-2332	D4C-2532	D4C-3332	D4C-3532
Sealed crossroller plunger 	3	D4C-2233	D4C-2433	D4C-3233	D4C-3433
	5	D4C-2333	D4C-2533	D4C-3333	D4C-3533
Plastic rod 	3	D4C-2250	D4C-2450	D4C-3250	D4C-3450
	5	D4C-2350	D4C-2550	D4C-3350	D4C-3550
Center roller lever 	3	D4C-2260	D4C-2460	D4C-3260	D4C-3460
	5	D4C-2360	D4C-2560	D4C-3360	D4C-3560

Note: Ask your nearest OMRON representative for information on Switching with approved international standards.

*1. Oil-resistant vinyl cabtire cables; approved by EN and IEC.





*2. Ordinary vinyl cabtire cables.; approved by EN and IEC.

Microload Switches with Operation Indicator

Actuator	Ratings Cable Cable length (m)	0.1 A at 125 VAC		0.1 A at 30 VDC	
		VCTF oil-resistant cable*		VCTF oil-resistant cable*	
		Model			
Pin plunger 	3	D4C-5201		D4C-6201	
	5	---		D4C-6301	
Roller plunger 	3	D4C-5202		D4C-6202	
	5	D4C-5302		D4C-6302	
Crossroller plunger 	3	D4C-5203		D4C-6203	
	5	D4C-5303		D4C-6303	
Roller lever 	3	D4C-5220		D4C-6220	
	5	D4C-5320		D4C-6320	
Roller lever, high-sensitivity 	3	D4C-5224		D4C-6224	
	5	D4C-5324		D4C-6324	
Sealed pin plunger 	3	---		D4C-6231	
	5	---		D4C-6331	
Sealed roller plunger 	3	D4C-5232		D4C-6232	
	5	D4C-5332		D4C-6332	
Sealed crossroller plunger 	3	---		D4C-6233	
	5	---		D4C-6333	
Plastic rod 	3	D4C-5250		D4C-6250	
	5	D4C-5350		D4C-6350	

Note: Ask your nearest OMRON representative for information on Switching with approved international standards.
* Oil-resistant vinyl cabtire cables; approved by EN and IEC.

Pre-wired Models (Use VCTF Oil-resistant Cable)

Actuator	Ratings Operation indicator	1 A at 125 VAC		1 A at 30 VDC	
		Without operation indicator	With operation indicator	Without operation indicator	With operation indicator
Pin plunger 		D4C-1001-AK1EJ□	D4C-2001-AK1EJ□	D4C-1001-DK1EJ□	D4C-3001-DK1EJ□
Roller plunger 		D4C-1002-AK1EJ□	D4C-2002-AK1EJ□	D4C-1002-DK1EJ□	D4C-3002-DK1EJ□
Sealed plunger 		D4C-1031-AK1EJ□	D4C-2031-AK1EJ□	D4C-1031-DK1EJ□	D4C-3031-DK1EJ□
Sealed roller plunger 		D4C-1032-AK1EJ□	D4C-2032-AK1EJ□	D4C-1032-DK1EJ□	D4C-3032-DK1EJ□
Roller lever (high-sensitivity model) 		D4C-1024-AK1EJ□	D4C-2024-AK1EJ□	D4C-1024-DK1EJ□	D4C-3024-DK1EJ□

Note: 1. The □ contains the length of the cable.
For example: 30 cm → 4C-1001-AK1EJ03
2. M1J models are also available. Contact your OMRON sales representative for further information.
3. Of the above model numbers, some with special specifications are not registered.

Weather-resistant Models

Actuator	Operation indicator	Ratings Cable length (m)	Without operating indication		With operating indication	
			Standard	Microload	Standard	
			5 A at 250 VAC 4 A at 30 VDC	0.1 A at 125 VAC 0.1 A at 30 VDC	5 A at 125 VAC	4 A at 30 VDC
Model						
Roller lever		3	D4C-1220-P	D4C-4220-P	D4C-2220-P	D4C-3220-P
		5	D4C-1320-P	---	---	---
Roller lever (high-sensitivity model)		3	D4C-1224-P	D4C-4224-P	D4C-2224-P	D4C-3224-P
		5	D4C-1324-P	D4C-4324-P	D4C-2324-P	D4C-3324-P
Adjustable roller lever		3	D4C-1227-P	D4C-4227-P	D4C-2227-P	D4C-3227-P
		5	D4C-1327-P	D4C-4327-P	D4C-2327-P	D4C-3327-P
Adjustable rod lever		3	D4C-1229-P	D4C-4229-P	---	D4C-3229-P
		5	D4C-1329-P	---	D4C-2329-P	D4C-3329-P

Note: Silicon rubber is used to increase resistance to the environment. Silicon rubber, however, can generate silicon gas. (This can occur at room temperature, but the amount of silicon gas generated increases at higher temperatures.) Silicon gas will react as a result of arc energy and form silicon oxide (SiO₂). If silicon oxide accumulates on the contacts, contact interference can occur and can interfere with the device. Before using a Switch, test it under actual application conditions (including the environment and operating frequency) to confirm that no problems will occur in actual.

Mounting Plates (Order Separately)

The WL model incorporated by equipment can be replaced with the D4C together with the Mounting Plate without changing the position of the dog or cam.

List of Replaceable Models

WL model (Actuator)	D4C model (Actuator)	Plate
WLD/WL01D (Top plunger)	➔ D4C-□□01 (Plunger)	D4C-P001
WLD2/WL01D2 (Top roller plunger)	➔ D4C-□□02 (Roller plunger)	D4C-P002
WLCA2/WL01CA2 (Roller lever)	➔ D4C-□□20 (Roller lever)	D4C-P020

Note: The WL01□ is for micro loads.

Example of Replacement

Note: The position of the dog remains unchanged.

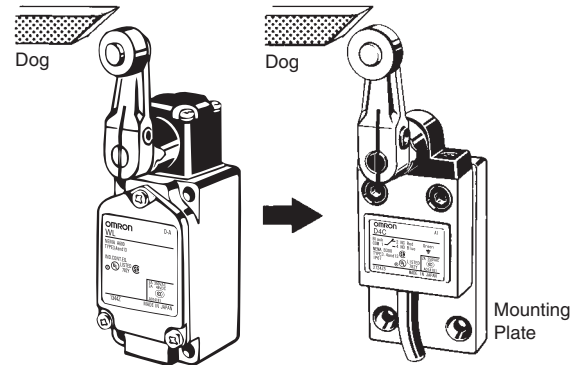

Individual Parts

Head/Actuator

Actuator	Head (with actuator)	Actuator
Pin plunger	D4C-0001	---
Roller plunger	D4C-0002	---
Crossroller plunger	D4C-0003	---
Roller lever	D4C-0020	WL-1A100
Environment-resistant roller lever	D4C-0020-P	WL-1A100P1
Roller lever	D4C-0024	WL-1A100
Variable roller lever	D4C-0027	HL-1HPA320
Variable rod lever	D4C-0029	HL-1HPA500
Sealed pin plunger	D4C-0031	---
Sealed roller plunger	D4C-0032	---
Sealed crossroller plunger	D4C-0033	---
Plastic rod	D4C-0050	---
Center roller lever	D4C-0060	---

Note: 1. The model numbers for heads are of the form D4C-00□□, with the numbers in the squares indicating the type of actuator.
 2. Actuators for plunger models, plastic rod models, and center roller lever models cannot be ordered individually. They must be ordered together with the head.

Specifications

Approved Standards

Agency	Standard	File No.
TÜV Product Service	EN60947-5-1	*1, 3
UL	UL508	E76675 *2
CSA	CSA C22.2 No.14	LR45746 *2
CCC(CQC)	GB14048.5	2003010305077626 *3

- *1. Models with VCTF oil-resistant cables and pre-wired models only. (Applicable only to standard models listed on pages 2 to 4.)
- *2. SJT(O)-cable models only. (Applicable only to standard models listed on pages 2 to 3.)
- *3. Ask your OMRON representative for information on approved models.

Ratings

Standard Model

Rated voltage	Non-inductive load (A)				Inductive load (A)			
	Resistive load		Lamp load		Inductive load		Motor load	
	NC	NO	NC	NO	NC	NO	NC	NO
125 VAC	5 (0.1)		1.5	0.7	3		2.5	1.3
250 VAC	5		1	0.5	2		1.5	0.8
8 VDC	5 (0.1)		2		5	4	3	
14 VDC	5 (0.1)		2		4	4	3	
30 VDC	4 (0.1)		2		3	3	3	
125 VDC	0.4		0.05		0.4		0.05	
250 VDC	0.2		0.03		0.2		0.03	

Inrush current	NC	20 A max.
	NO	10 A max.

- Note: 1. The values given on the left are steady-state currents.
 2. Inductive loads have a power factor of 0.4 min. (AC) and a time constant of 7 ms max. (DC).
 3. Lamp loads have an inrush current of 10 times the steady-state current.
 4. Motor loads have an inrush current of 6 times the steady-state current.
 5. The values "0.1" given in parentheses are for micro load models.

Pre-wired Model

Rated voltage	Non-inductive load (A)				Inductive load (A)			
	Resistive load		Lamp load		Inductive load		Motor load	
	NC	NO	NC	NO	NC	NO	NC	NO
125 VAC	1	1	1	0.7	1	1	1	1
30 VDC	1	1	1	1	1	1	1	1

Approved Standard Ratings

TÜV (EN60947-5-1), CCC (GB14048.5)

Model	Applicable category and ratings	I the
D4C-1□□□	AC-15 2 A/250 V DC-12 2 A/30 V	5 A 4 A
D4C-2□□□	AC-15 2 A/125 V	5 A
D4C-3□□□	DC-12 2 A/30 V	4 A
D4C-4□□□	AC-14 0.1 A/125 V DC-12 0.1 A/30 V	0.5 A 0.5 A
D4C-5□□□	AC-14 0.1 A/125 V	0.5 A
D4C-6□□□	DC-12 0.1 A/30 V	0.5 A

UL/CSA

B300 (D4C-16□□, -17□□)

B150 (D4C-26□□, -27□□)

B300

Rated voltage	Carry current	Current (A)		Volt-amperes (VA)	
		Make	Break	Make	Break
120 VAC	5 A	30	3	3,600	360
240 VAC		15	1.5	3,600	360

B150

Rated voltage	Carry current	Current (A)		Volt-amperes (VA)	
		Make	Break	Make	Break
120 VAC	5 A	30	3	3,600	360

Characteristics

Degree of protection	IP67	
Durability *1	Mechanical *3	10,000,000 operations min.
	Electrical *2	200,000 operations min. (5 A at 125 VAC, resistive load)
Operating speed	0.1 mm/s to 0.5 m/s (in case of plunger) 1 mm/s to 1 m/s (in case of roller lever)	
Operating frequency	Mechanical	120 operations/min
	Electrical	30 operations/min
Rated frequency	50/60 Hz	
Insulation resistance	100 MΩ min. (at 500 VDC)	
Contact resistance (initial)	250 mΩ max. (initial value with 2-m VCTF cable)	
	300 mΩ max. (initial value with 3-m VCTF cable)	
	400 mΩ max. (initial value with 5-m VCTF cable)	
Dielectric strength	Between terminals of the same polarity	1,000 VAC, 50/60 Hz for 1 min
	Between current-carrying metal part and ground	1,500 VAC, 50/60 Hz for 1 min Uimp: 2.5 kV (EN60947-5-1)
Dielectric strength	Between each terminal and non-current-carrying metal part,	1,500 VAC, 50/60 Hz for 1 min Uimp: 2.5 kV(EN60947-5-1)
	Rated insulation voltage (Ui)	300 V (EN60947-5-1) *5
Pollution degree (operating environment)	3 (EN60947-5-1)	
Short-circuit protective device (SCPD)	10 A fuse type gI or gG (IEC60269)	
Conditional short-circuit current	100 A (EN60947-5-1)	
Conventional enclosed thermal current (I the)	5 A, 4 A, 0.5 A (EN60947-5-1)	
Protection against electric shock	Class I (with grounding wire) *6	
Vibration resistance	Malfunction	10 to 55 Hz, 1.5-mm double amplitude *4
Shock resistance	Destruction	1,000 m/s ² min.
	Malfunction	500 m/s ² min. *4
Ambient operating temperature	-10°C to +70°C (with no icing)	
Ambient operating humidity	35% to 95%RH	
Weight (D4C-1202)	With 3-m VCTF cable: 360 g	
	With 5-m VCTF cable: 540 g	

Note: The above figures are initial values.

- *1. The values are calculated at an operating temperature of +5°C to +35°C, and an operating humidity of 40% to 70%RH. Contact your OMRON sales representative for more detailed information on other operating environments.
- *2. Pre-wired Models: 1,000,000 operations min. (DC specifications, switching current: 0.1 A)
- *3. Outdoor specifications: 500,000 operations min.
- *4. Excluding Plastic Rods.
- *5. Pre-wired models: 250 V
- *6. Pre-wired models: class III

Engineering Data

Electrical Durability

D4C-1□□□, -2□□□, -3□□□



D4C-4□□□, -5□□□, -6□□□



Leakage Current for LED-indicator Models

The leakage currents and resistances of LED-indicator models are given in the following table.

Model	Voltage	Leakage current	Resistance
D4C-2□□□	125 VAC	1.7 mA	68 kΩ
D4C-3□□□	30 VDC	1.7 mA	15 kΩ
D4C-5□□□	125 VAC	1.7 mA	68 kΩ
D4C-6□□□	30 VDC	1.7 mA	15 kΩ

Structure and Nomenclature

Structure

Standard Models

Roller Lever Models Without Indicator

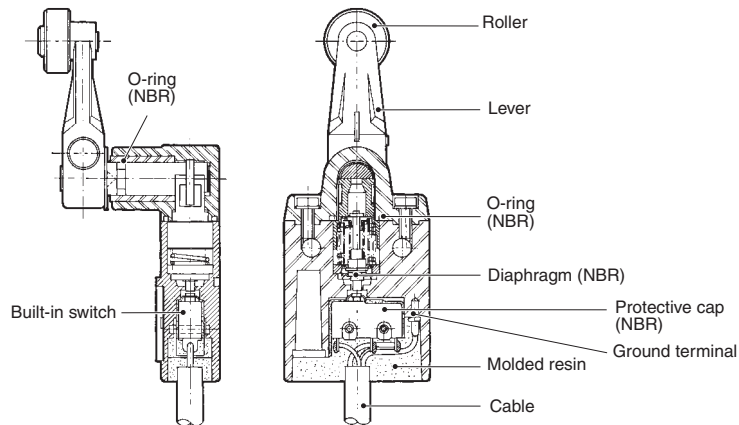

Weather-resistant Models

Roller Lever Models Without Indicator

Roller

The roller is made of self-lubricating sintered stainless steel and boasts high resistance to wear.

Shaft Section Seal

By fitting an O-ring to the rotary shaft and with an appropriate interference of the screws, high-sealing properties are maintained. The O-ring is made of silicone rubber and is resistant to temperature changes and adverse weather conditions.

Head-mounting Screw

The diaphragm is made of silicone rubber and is resistant to temperature changes and adverse weather conditions.

Cable

Vinyl cable and is resistant to adverse weather conditions.

Lever

The lever forged of anti-corrosive aluminium alloy features high corrosion resistances and outstanding ruggedness.

Roller Lever Setscrew

This screw is made of stainless steel and has high corrosion resistance.

Rotary Shaft

The shaft is made of stainless steel decreasing the likelihood of rusting.

Built-in Switch

Both standard load and microload models available.

Contact Form

Standard Models/Weather-resistant Models

Without Operation Indicator



**With Operation Indicator
(Lit when Not Actuated)**

<24 VDC LED>



<100 VAC LED>



Connector Models for ASI Devices (-M1J)

Without Operation Indicator



**With Operation Indicator
(Lit when Not Actuated)**



For DC



Pre-wired Models (-AK1EJ□, -DK1EJ□)

Without Operation Indicator



**With Operation Indicator
(Lit when Not Actuated)**

<24 VDC LED>



<100 VAC LED>



For AC

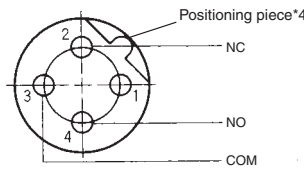

For DC

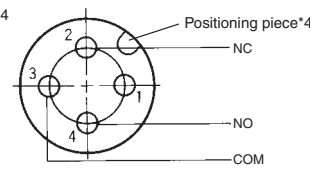

*1. Yellow/green: VCTF oil-resistant cable
Green: VCTF cable

*2. SJT(O) cable approved by UL and CSA.

*3. E (ground) is not grounded.

*4. The position of the positioning piece is not fixed. Using an L-shaped connector may result in failure. Use only a straight connector.

Note: "Lit when not Actuated" means that when the actuator is in the free position, the indicator is lit, and when the actuator is turned or pushed and the contact comes into contact with the NO side, the indicator turns OFF.

Dimensions and Operating Characteristics

Switches

Standard Models

Models without LED indicators are shown in the illustrations and dimensions diagrams. Refer to page 11 for *Models with LED Indicators*. The boxes in the model numbers are replaced with the rating and cable type. Refer to page 1 for the *Model Number Structure*.

Pin Plunger

D4C-□□01



Roller Lever

D4C-□□20

D4C-□□20-P



Roller Plunger

D4C-□□02



Roller Lever (High-Sensitivity Model)

D4C-□□24

D4C-□□24-P

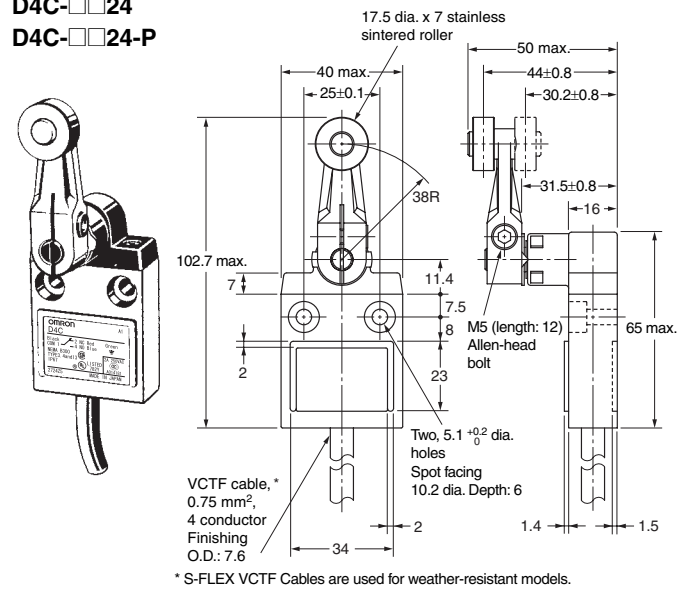

Crossroller Plunger

D4C-□□03



Note: Unless otherwise specified, a tolerance of ±0.4 mm applies to all dimensions.

Model		D4C-□□01	D4C-□□02	D4C-□□03	D4C-□□20 D4C-□□20-P	D4C-□□24 D4C-□□24-P
Operating force	OF max.	11.77 N	11.77 N	11.77 N	5.69 N	5.69 N
Release force	RF min.	4.41 N	4.41 N	4.41 N	1.47 N	1.47 N
Pretravel	PT max.	1.8 mm	1.8 mm	1.8 mm	25°	10°±3°
Overtravel	OT min.	3 mm	3 mm	3 mm	40°	50°
Movement Differential	MD max.	0.2 mm	0.2 mm	0.2 mm	3°	3°
Operating Position	OP	15.7±1 mm	28.5±1 mm	28.5±1 mm	---	---

Sealed Plunger
D4C-□□31



Sealed Roller Plunger
D4C-□□32



Sealed Crossroller Plunger
D4C-□□33



Note: Unless otherwise specified, a tolerance of ± 0.4 mm applies to all dimensions.

Operating characteristics	Model	D4C-□□31	D4C-□□32	D4C-□□33
Operating force	OF max.	17.65 N	17.65 N	17.65 N
Release force	RF min.	4.41 N	4.41 N	4.41 N
Pretravel	PT max.	1.8 mm	1.8 mm	1.8 mm
Overtravel	OT min.	3 mm	3 mm	3 mm
Movement Differential	MD max.	0.2 mm	0.2 mm	0.2 mm
Operating Position	OP	24.9±1 mm	34.3±1 mm	34.3±1 mm
Total travel	TT *	(5) mm	(5) mm	(5) mm

* The TT is a reference value.

**Plastic rod
D4C-□□50**



*1 Operation is possible in any direction except in parallel to the axis.
*2 The ideal range for operation is between the tip of the rod and 1/3 of the length of the actuator.

**Center Roller Lever Plunger
D4C-□□60**



Note: Unless otherwise specified, a tolerance of ±0.4 mm applies to all dimensions.

Operating characteristics		Model	D4C-□□50	D4C-□□60
Operating force	OF	max.	1.47 N	6.67 N
Release force	RF	min.	---	1.47 N
Pretravel	PT	max.	15°	10°±3°
Overtravel	OT	min.	---	50°
Movement Differential	MD	max.	---	3°
Operating Position	OP		---	---
Total travel	TT		---	---

Models with LED Indicator

The dimensions of the LED indicator for models equipped with one are shown below.



Pre-wired Models

**Pin Plunger
D4C-□001-□K1EJ□
D4C-□001-M1J□**

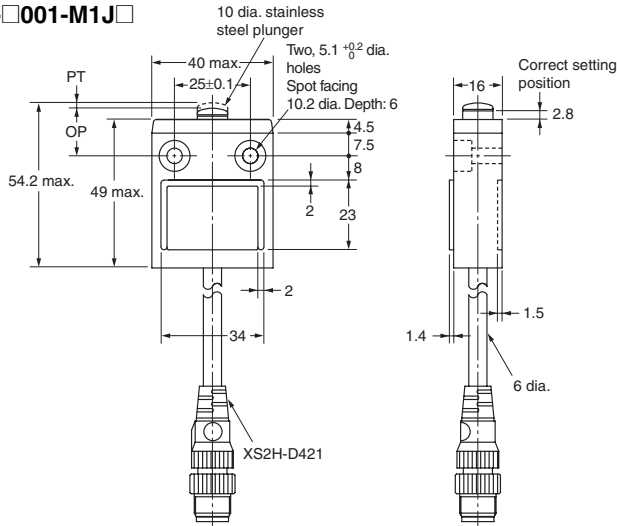

**Roller Plunger
D4C-□002-□K1EJ□
D4C-□002-M1J□**



Note: Unless otherwise specified, a tolerance of ±0.4 mm applies to all dimensions.

Operating characteristics		Model	D4C-□001-□K1EJ□	D4C-□002-□K1EJ□
Operating force	OF	max.	11.77 N	11.77 N
Release force	RF	min.	4.41 N	4.41 N
Pretravel	PT	max.	1.8 mm	1.8 mm
Overtravel	OT	min.	3 mm	3 mm
Movement Differential	MD	max.	0.2 mm	0.2 mm
Operating Position	OP		15.7±1 mm	28.5±1 mm

Note: Specifications are the same for -M1J Switches.

Sealed Pin Plunger

D4C-□031-□K1EJ□

D4C-□031-M1J□



Sealed Roller Plunger

D4C-□032-□K1EJ□

D4C-□032-M1J□



Note: Unless otherwise specified, a tolerance of ± 0.4 mm applies to all dimensions.

Operating characteristics		Model	D4C-□031-□K1EJ□	D4C-□032-□K1EJ□
Operating force	OF	max.	17.65 N	17.65 N
Release force	RF	min.	4.41 N	4.41 N
Pretravel	PT	max.	1.8 mm	1.8 mm
Overtravel	OT	min.	3 mm	3 mm
Movement Differential	MD	max.	0.2 mm	0.2 mm
Operating Position	OP		24.9 \pm 1 mm	34.3 \pm 1 mm

Note: Specifications are the same for -M1J Switches

Roller Lever (High-sensitivity Model)

D4C-□024-□K1EJ□

D4C-□024-M1J□



Note: Unless otherwise specified, a tolerance of ± 0.4 mm applies to all dimensions.

Operating characteristics		Model	D4C-□024-□K1EJ□
Operating force	OF	max.	5.69 N
Release force	RF	min.	1.47 N
Pretravel	PT	max.	10 $^{\circ}$ \pm 3 $^{\circ}$
Overtravel	OT	min.	50 $^{\circ}$
Movement Differential	MD	max.	3 $^{\circ}$
Operating Position	OP		---

Note: Specifications are the same for -M1J Switches

Operation

- Operation method, shapes of cam and dog, operating frequency, and overtravel have a significant effect on the service life and precision of a Limit Switch. For this reason, the dog angle must be 30° max., the surface roughness of the dog must be 6.3 S min. and hardness must be Hv 400 to 500.
- To allow the plunger-type actuator to travel properly, adjust the dog and cam to the proper setting positions. The proper position is where the plunger groove fits the bushing top.



- To allow the roller lever-type actuator to travel properly, adjust the dog and cam so that the arrow head is positioned between the two convex markers as shown below.



Mounting

- A maximum of 6 Switches may be group-mounted. In this case, pay attention to the mounting direction so that the convex part of the group-mounting guide on one Switch fits into the concave part of the guide on the other Switch as shown in the figure below. For group mounting, the mounting panel must have a thickness (t) of 6 mm min.



- If the mounting panel is warped or has protruding parts, a malfunction may result. Make sure that the mounting panel is not warped and has even surfaces.

Mounting Holes



- Use a Switch with a rubber cap when using the plunger type in an environment where malfunction is possible due to environmental conditions such as dust or cutting chips which may not allow resetting.
- Do not expose the Switch to water exceeding 70°C or use it in steam.
- When the D4C is used in a circuit of a device to be exported to Europe, classified as Overvoltage Class III as specified in IEC664, provide a contact protection circuit.
- Tighten each screw to a torque according to the following table.

No.	Type	Appropriate tightening torque*
1	M5 Allen-head bolt	4.90 to 5.88 N·m
2	M3.5 head mounting screw	0.78 to 0.88 N·m
3	M5 Allen-head bolt	4.90 to 5.88 N·m

* By removing the two screws from the head, the head direction can be rotated 180°. After changing the head direction, re-tighten to the torque specified above. Be careful not to allow any foreign substance to enter the Switch.



Micro-load Models (D4C-4, -5, -6)

Micro-load models can be used for switching in the range shown below.



Read and Understand This Catalog

Please read and understand this catalog before purchasing the products. Please consult your OMRON representative if you have any questions or comments.

Warranty and Limitations of Liability

WARRANTY

OMRON's exclusive warranty is that the products are free from defects in materials and workmanship for a period of one year (or other period if specified) from date of sale by OMRON.

OMRON MAKES NO WARRANTY OR REPRESENTATION, EXPRESS OR IMPLIED, REGARDING NON-INFRINGEMENT, MERCHANTABILITY, OR FITNESS FOR PARTICULAR PURPOSE OF THE PRODUCTS. ANY BUYER OR USER ACKNOWLEDGES THAT THE BUYER OR USER ALONE HAS DETERMINED THAT THE PRODUCTS WILL SUITABLY MEET THE REQUIREMENTS OF THEIR INTENDED USE. OMRON DISCLAIMS ALL OTHER WARRANTIES, EXPRESS OR IMPLIED.

LIMITATIONS OF LIABILITY

OMRON SHALL NOT BE RESPONSIBLE FOR SPECIAL, INDIRECT, OR CONSEQUENTIAL DAMAGES, LOSS OF PROFITS OR COMMERCIAL LOSS IN ANY WAY CONNECTED WITH THE PRODUCTS, WHETHER SUCH CLAIM IS BASED ON CONTRACT, WARRANTY, NEGLIGENCE, OR STRICT LIABILITY.

In no event shall the responsibility of OMRON for any act exceed the individual price of the product on which liability is asserted.

IN NO EVENT SHALL OMRON BE RESPONSIBLE FOR WARRANTY, REPAIR, OR OTHER CLAIMS REGARDING THE PRODUCTS UNLESS OMRON'S ANALYSIS CONFIRMS THAT THE PRODUCTS WERE PROPERLY HANDLED, STORED, INSTALLED, AND MAINTAINED AND NOT SUBJECT TO CONTAMINATION, ABUSE, MISUSE, OR INAPPROPRIATE MODIFICATION OR REPAIR.

Application Considerations

SUITABILITY FOR USE

OMRON shall not be responsible for conformity with any standards, codes, or regulations that apply to the combination of products in the customer's application or use of the products.

At the customer's request, OMRON will provide applicable third party certification documents identifying ratings and limitations of use that apply to the products. This information by itself is not sufficient for a complete determination of the suitability of the products in combination with the end product, machine, system, or other application or use.

The following are some examples of applications for which particular attention must be given. This is not intended to be an exhaustive list of all possible uses of the products, nor is it intended to imply that the uses listed may be suitable for the products:

- Outdoor use, uses involving potential chemical contamination or electrical interference, or conditions or uses not described in this catalog.
- Nuclear energy control systems, combustion systems, railroad systems, aviation systems, medical equipment, amusement machines, vehicles, safety equipment, and installations subject to separate industry or government regulations.
- Systems, machines, and equipment that could present a risk to life or property.

Please know and observe all prohibitions of use applicable to the products.

NEVER USE THE PRODUCTS FOR AN APPLICATION INVOLVING SERIOUS RISK TO LIFE OR PROPERTY WITHOUT ENSURING THAT THE SYSTEM AS A WHOLE HAS BEEN DESIGNED TO ADDRESS THE RISKS, AND THAT THE OMRON PRODUCTS ARE PROPERLY RATED AND INSTALLED FOR THE INTENDED USE WITHIN THE OVERALL EQUIPMENT OR SYSTEM.

PROGRAMMABLE PRODUCTS

OMRON shall not be responsible for the user's programming of a programmable product, or any consequence thereof.

Disclaimers

CHANGE IN SPECIFICATIONS

Product specifications and accessories may be changed at any time based on improvements and other reasons.

It is our practice to change model numbers when published ratings or features are changed, or when significant construction changes are made. However, some specifications of the products may be changed without any notice. When in doubt, special model numbers may be assigned to fix or establish key specifications for your application on your request. Please consult with your OMRON representative at any time to confirm actual specifications of purchased products.

DIMENSIONS AND WEIGHTS

Dimensions and weights are nominal and are not to be used for manufacturing purposes, even when tolerances are shown.

PERFORMANCE DATA

Performance data given in this catalog is provided as a guide for the user in determining suitability and does not constitute a warranty. It may represent the result of OMRON's test conditions, and the users must correlate it to actual application requirements. Actual performance is subject to the OMRON Warranty and Limitations of Liability.

ERRORS AND OMISSIONS

The information in this document has been carefully checked and is believed to be accurate; however, no responsibility is assumed for clerical, typographical, or proofreading errors, or omissions.

2008.11

In the interest of product improvement, specifications are subject to change without notice.

OMRON Corporation
Industrial Automation Company

<http://www.ia.omron.com/>

(c)Copyright OMRON Corporation 2008 All Right Reserved.



Стандарт Электрон Связь

Мы молодая и активно развивающаяся компания в области поставок электронных компонентов. Мы поставляем электронные компоненты отечественного и импортного производства напрямую от производителей и с крупнейших складов мира.

Благодаря сотрудничеству с мировыми поставщиками мы осуществляем комплексные и плановые поставки широчайшего спектра электронных компонентов.

Собственная эффективная логистика и склад в обеспечивает надежную поставку продукции в точно указанные сроки по всей России.

Мы осуществляем техническую поддержку нашим клиентам и предпродажную проверку качества продукции. На все поставляемые продукты мы предоставляем гарантию .

Осуществляем поставки продукции под контролем ВП МО РФ на предприятия военно-промышленного комплекса России , а также работаем в рамках 275 ФЗ с открытием отдельных счетов в уполномоченном банке. Система менеджмента качества компании соответствует требованиям ГОСТ ISO 9001.

Минимальные сроки поставки, гибкие цены, неограниченный ассортимент и индивидуальный подход к клиентам являются основой для выстраивания долгосрочного и эффективного сотрудничества с предприятиями радиоэлектронной промышленности, предприятиями ВПК и научно-исследовательскими институтами России.

С нами вы становитесь еще успешнее!

Наши контакты:

Телефон: +7 812 627 14 35

Электронная почта: sales@st-electron.ru

Адрес: 198099, Санкт-Петербург,
Промышленная ул, дом № 19, литера Н,
помещение 100-Н Офис 331