

45 V power Schottky rectifier

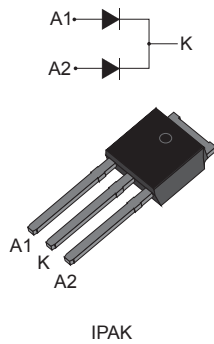

Features

- Very small conduction losses
- Avalanche specification
- Low forward voltage drop
- High frequency operation
- ECOPACK[®]2 compliant

Applications

- DC/DC converter
- Battery charger
- SMPS
- Desktop power
- Auxiliary power

Description

This dual-diode common cathode Schottky rectifier is ideal for high frequency switch mode power supply.

Packaged in IPAK, the [STPS2045CH](#) is optimized for notebook, game station and desktop adapters, providing in these applications a good efficiency at both low and high load.

Product status link

[STPS2045CH](#)

Product summary

$I_{F(AV)}$	2 x 10 A
V_{RRM}	45 V
V_F (typ.)	0.50 V
T_j (max.)	175 °C

1 Characteristics

Table 1. Absolute ratings (limiting values, at 25 °C unless otherwise specified)

Symbol	Parameter		Value	Unit
V _{RRM}	Repetitive peak reverse voltage		45	V
I _{F(RMS)}	Forward rms current		20	A
I _{F(AV)}	Average forward current $\delta = 0.5$, square wave	T _C = 155 °C Per diode	10	A
		T _C = 150 °C Per device	20	
I _{FSM}	Surge non repetitive forward current	t _p = 10 ms sine-wave	150	A
P _{ARM}	Repetitive peak avalanche power	t _p = 10 μ s, T _j = 125 °C	280	W
T _{stg}	Storage temperature range		-65 to +175	°C
T _j	Maximum operating junction temperature ⁽¹⁾		+175	°C

1. $(dP_{tot}/dT_j) < (1/R_{th(j-a)})$ condition to avoid thermal runaway for a diode on its own heatsink.

Table 2. Thermal resistance parameters

Symbol	Parameter		Value	Unit
R _{th(j-c)}	Junction to case	Per diode	2.5	°C/W
		Total	1.6	
R _{th(c)}	Coupling		0.7	

For more information, please refer to the following application note :

- AN5088 : Rectifiers thermal management, handling and mounting recommendations

Table 3. Static electrical characteristics

Symbol	Parameter	Test conditions		Min.	Typ.	Max.	Unit
I _R ⁽¹⁾	Reverse leakage current	T _j = 25 °C	V _R = V _{RRM}	-		100	μ A
		T _j = 125 °C		-	7	15	mA
V _F ⁽²⁾	Forward voltage drop	T _j = 125 °C	I _F = 10 A	-	0.50	0.57	V
		T _j = 25 °C	I _F = 20 A	-		0.84	
				T _j = 125 °C	-	0.65	

1. Pulse test: t_p = 5 ms, $\delta < 2\%$

2. Pulse test: t_p = 380 μ s, $\delta < 2\%$

To evaluate the conduction losses, use the following equation:

$$P = 0.42 \times I_{F(AV)} + 0.015 \times I_F^2 (RMS)$$

For more information, please refer to the following application notes related to the power losses :

- AN604: Calculation of conduction losses in a power rectifier
- AN4021: Calculation of reverse losses on a power diode

1.1 Characteristics (curves)

Figure 1. Average forward power dissipation versus average forward current (per diode)

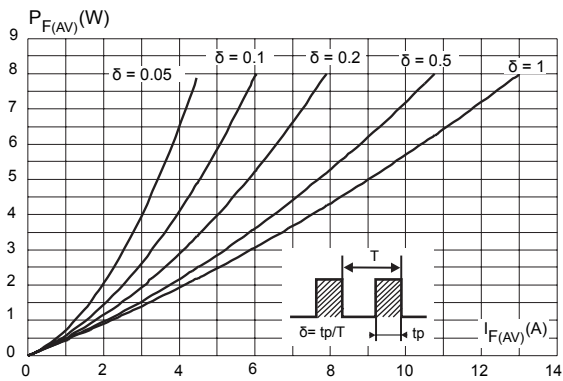

Figure 2. Average forward current versus ambient temperature ($\delta = 0.5$, per diode)

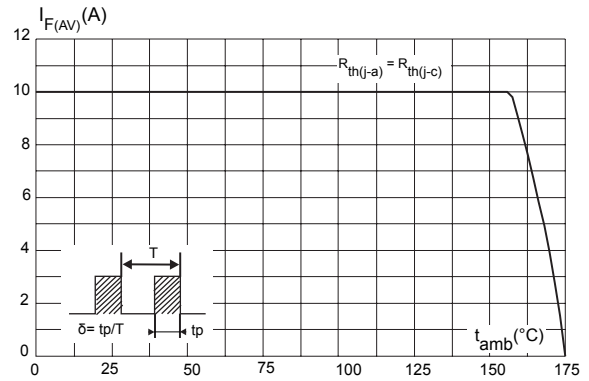

Figure 3. Normalized avalanche power derating versus pulse duration ($T_j = 125^{\circ}C$)

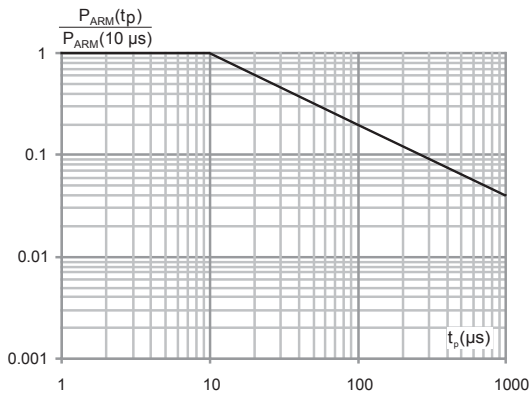

Figure 4. Relative variation of thermal impedance junction to case versus pulse duration

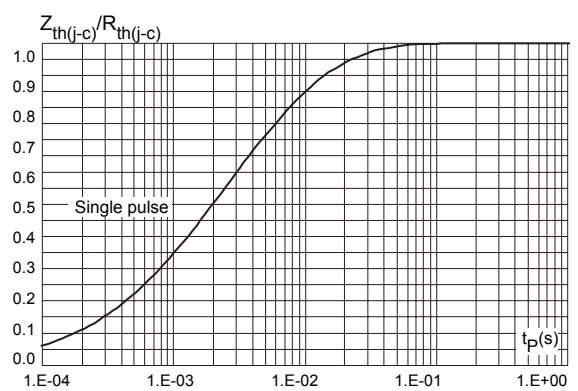

Figure 5. Reverse leakage current versus reverse voltage applied (typical values, per diode)

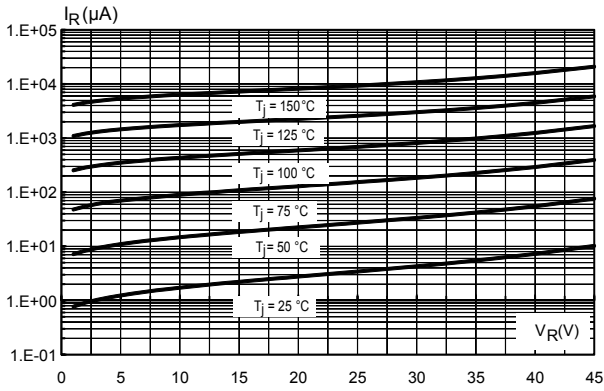

Figure 6. Junction capacitance versus reverse voltage applied (typical values, per diode)

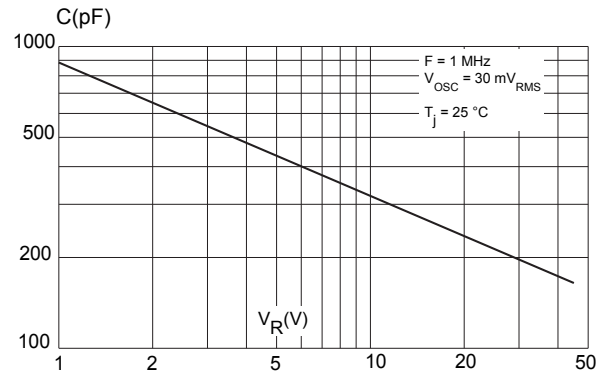
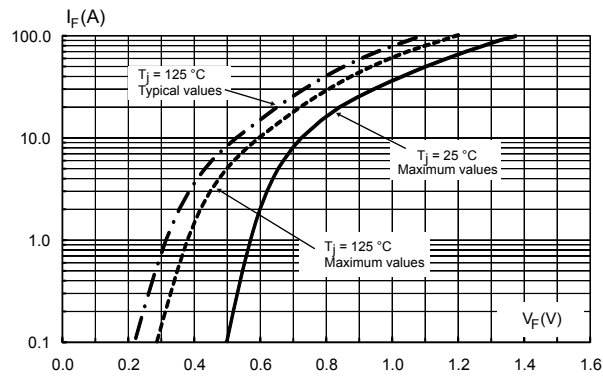

Figure 7. Forward voltage drop versus forward current (per diode)



2 Package information

In order to meet environmental requirements, ST offers these devices in different grades of ECOPACK® packages, depending on their level of environmental compliance. ECOPACK® specifications, grade definitions and product status are available at: www.st.com. ECOPACK® is an ST trademark.

2.1 IPAK package information

- Cooling method: by conduction (C)
- Epoxy meets UL 94,V0

Figure 8. IPAK package outline

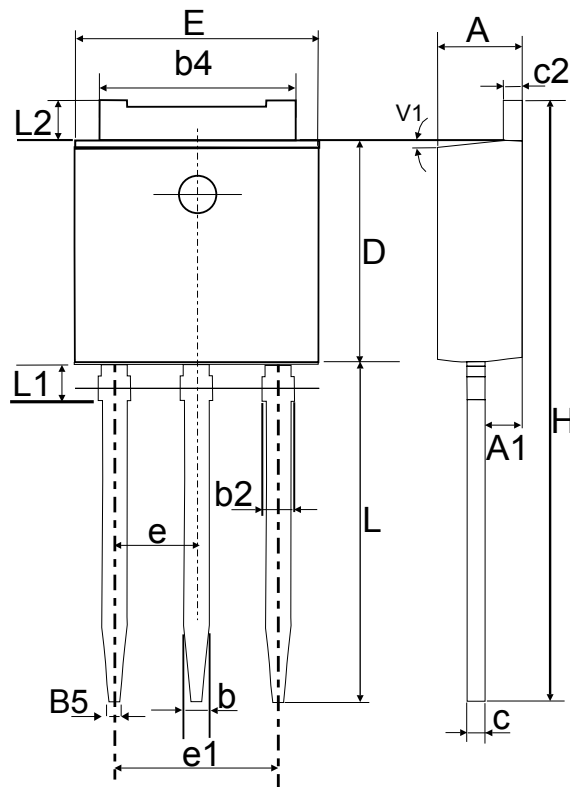

Table 4. IPAK package mechanical data

Ref.	Dimensions			
	Millimeters		Inches	
	Min.	Max.	Min.	Max.
A	2.20	2.40	0.087	0.094
A1	0.90	1.10	0.035	0.043
b	0.64	0.90	0.025	0.035
b2		0.95		0.037
b4	5.20	5.43	0.205	0.214
B5	0.30 typ.		0.012 typ.	
c	0.45	0.60	0.018	0.024
c2	0.46	0.60	0.018	0.024
D	6.00	6.20	0.236	0.244
E	6.40	6.65	0.252	0.261
e	2.28 typ.		typ.0.090	
e1	4.40	4.60	0.173	0.181
H	16.10 typ.		0.634 typ.	
L	9.0	9.60	0.354	0.378
L1	0.80	1.20	0.031	0.047
L2	0.80 typ.	1.25	0.031 typ.	0.049
V1	+10°		+10	

3 Ordering information

Table 5. Ordering information

Order code	Marking	Package	Weight	Base qty.	Delivery mode
STPS2045CH	S20 45CH	IPAK	0.31 g	75	Tube

Revision history

Table 6. Document revision history

Date	Version	Changes
21-Jun-2012	1	First issue.
09-Oct-2014	2	Updated Table 2 and IPAK package informations.
27-Nov-2018	3	Removed figure 1 and figure 9. Updated Table 1. Absolute ratings (limiting values, at 25 °C unless otherwise specified), Figure 5. Reverse leakage current versus reverse voltage applied (typical values, per diode), Figure 7. Forward voltage drop versus forward current (per diode) and Table 5. Ordering information.

IMPORTANT NOTICE – PLEASE READ CAREFULLY

STMicroelectronics NV and its subsidiaries (“ST”) reserve the right to make changes, corrections, enhancements, modifications, and improvements to ST products and/or to this document at any time without notice. Purchasers should obtain the latest relevant information on ST products before placing orders. ST products are sold pursuant to ST’s terms and conditions of sale in place at the time of order acknowledgement.

Purchasers are solely responsible for the choice, selection, and use of ST products and ST assumes no liability for application assistance or the design of Purchasers’ products.

No license, express or implied, to any intellectual property right is granted by ST herein.

Resale of ST products with provisions different from the information set forth herein shall void any warranty granted by ST for such product.

ST and the ST logo are trademarks of ST. All other product or service names are the property of their respective owners.

Information in this document supersedes and replaces information previously supplied in any prior versions of this document.

© 2018 STMicroelectronics – All rights reserved



**Стандарт
Электрон
Связь**

Мы молодая и активно развивающаяся компания в области поставок электронных компонентов. Мы поставляем электронные компоненты отечественного и импортного производства напрямую от производителей и с крупнейших складов мира.

Благодаря сотрудничеству с мировыми поставщиками мы осуществляем комплексные и плановые поставки широчайшего спектра электронных компонентов.

Собственная эффективная логистика и склад в обеспечивает надежную поставку продукции в точно указанные сроки по всей России.

Мы осуществляем техническую поддержку нашим клиентам и предпродажную проверку качества продукции. На все поставляемые продукты мы предоставляем гарантию .

Осуществляем поставки продукции под контролем ВП МО РФ на предприятия военно-промышленного комплекса России , а также работаем в рамках 275 ФЗ с открытием отдельных счетов в уполномоченном банке. Система менеджмента качества компании соответствует требованиям ГОСТ ISO 9001.

Минимальные сроки поставки, гибкие цены, неограниченный ассортимент и индивидуальный подход к клиентам являются основой для выстраивания долгосрочного и эффективного сотрудничества с предприятиями радиоэлектронной промышленности, предприятиями ВПК и научно-исследовательскими институтами России.

С нами вы становитесь еще успешнее!

Наши контакты:

Телефон: +7 812 627 14 35

Электронная почта: sales@st-electron.ru

Адрес: 198099, Санкт-Петербург,
Промышленная ул, дом № 19, литера Н,
помещение 100-Н Офис 331