

Middle Power Class-D Speaker Amplifiers

Class-D Speaker Amplifier for Digital Input with Built-in DSP

BM5446EFV

No.10075EBT13

●Description

BM5446EFV is a Class D Speaker Amplifier with built-in DSP (Digital Sound Processor) designed for Flat-panel TVs in particular for space-saving and low-power consumption, delivers an output power of 20W+20W. This IC employs state-of-the-art Bipolar, CMOS, and DMOS (BCD) process technology that eliminates turn-on resistance in the output power stage and internal loss due to line resistances up to an ultimate level. With this technology, the IC can achieve high efficiency of 86% (10W+10W output with 8Ω load). In addition, the IC is packaged in a compact reverse heat radiation type power package to achieve low power consumption and low heat generation and eliminates necessity of external heat-sink up to a total output power of 40W. This product satisfies both needs for drastic downsizing, low-profile structures and many function, high quality playback of sound system.

●Features

- 1) This IC includes the DSP (digital sound processor) for Audio signal processing for Flat TVs.
- 2) This IC has two input systems of digital audio interface.
(I²S/LJ/RJ format, LRCLK: 32 kHz / 44.1kHz / 48kHz, SYS_CLK: 256fs / 512fs,
BCLK: 48fs / 64fs, SDATA: 16 / 20 / 24bit)
- 3) With wide range of power supply voltage, it is possible to operate with single power supply. (V_{cc} = 10~26V)
- 4) With high efficiency and low heat dissipation contributing to miniaturization, slim design, and also power saving of the system.
- 5) S/N of the system can be optimized by adjusting the gain selection in 16 steps. (20~35dB, 1dB/step)
- 6) With built-in feedback circuitry at the output, prevents the decrease in sound quality due to change in power supply voltage. In addition, low noise and low distortion are achieved.
- 7) With a built-in DAC provides best stereo-output for headphone function. As a result, the selection of output of the digital input in two systems is possible.
- 8) It has additional S/PDIF output for the LINE output usage.
- 9) Eliminates pop-noise generated during the power supply on/off. High quality muting performance is realized by using the soft-muting technology.
- 10) This IC is built-in with various protection functions for highly reliability design.
(High temperature protection, Under voltage protection, Output short protection, Output DC-Voltage protection and Clock stop protection).

●Applications

Flat Panel TVs (LCD, Plasma), Home Audio, Desktop PC, Amusement equipments, Electronic Music equipments, etc.

● Absolute maximum ratings (Ta=25°C)

Parameter	Symbol	Ratings	Unit	Conditions
Supply voltage	V _{CC}	30	V	Pin 27, 30, 31, 51, 52 *1*2
Power dissipation	P _d	2.0	W	*3
		4.5	W	*4
		6.2	W	*5
Input voltage	V _{IN}	-0.3 ~ 4.5	V	Pin 5 ~ 14, 22 *1
Open-drain terminal voltage	V _{ERR}	-0.3 ~ 30	V	Pin 26 *1
Operating temperature range	T _{opr}	-25 ~ +85	°C	
Storage temperature range	T _{stg}	-55 ~ +150	°C	
Maximum junction temperature	T _{jmax}	+150	°C	

*1 The voltage that can be applied reference to GND (Pin 4, 36, 37, 45, 46) and VSS (Pin 15, 20).

*2 Do not, however exceed P_d and T_{jmax}=150°C.

*3 70mm×70mm×1.6mm, FR4, 1-layer glass epoxy board (Copper on bottom layer 0%)

Derating in done at 16mW/°C for operating above Ta=25°C.

*4 70mm×70mm×1.6mm, FR4, 2-layer glass epoxy board (Copper on bottom layer 100%)

Derating in done at 36mW/°C for operating above Ta=25°C. There are thermal via on the board.

*5 70mm×70mm×1.6mm, FR4, 4-layer glass epoxy board (Copper on bottom layer 100%)

Derating in done at 49.6mW/°C for operating above Ta=25°C. There are thermal via on the board.

● Operating conditions (Ta=25°C)

Parameter	Symbol	Ratings	Unit	Conditions
Supply voltage	V _{CC}	10 ~ 26	V	Pin 27, 30, 31, 51, 52 *1 *2
Minimum load impedance (Speaker Output)	R _{L_SP}	5.4	Ω	*6
Minimum load impedance (DAC Output)	R _{L_DA}	20	kΩ	Pin 24, 25

*6 Do not, however exceed P_d.

* No radiation-proof design.

●Electrical characteristics

(Unless otherwise specified Ta=25°C, Vcc=13V, f=1kHz, RL_SP=8Ω, RL_DA=20kΩ, RESETX=3.3V, MUTEX=3.3V, PDX=3.3V, Gain=20dB, DSP: Through, fs =48kHz)

Parameter	Symbol	Limits			Unit	Conditions
		Min.	Typ.	Max.		
Total circuit						
Circuit current	I _{CC1}	-	60	120	mA	Pin 27, 30, 31, 51, 52, No load
Circuit current (Power down mode)	I _{CC2}	-	2.5	5	mA	Pin 27, 30, 31, 51, 52, No load RESETX=0V, MUTEX=0V, PDX=0V
Open-drain terminal Low level voltage	V _{ERR}	-	-	0.8	V	Pin 26, I _o =0.5mA
Regulator output voltage 1	V _{REG_G}	5.0	5.5	6.0	V	Pin 28, 54
Regulator output voltage 2	V _{REG_3}	3.0	3.3	3.6	V	Pin 3
Regulator output voltage 3	V _{REG_15}	1.3	1.5	1.7	V	Pin 16
High level input voltage	V _{IH}	2.5	-	3.3	V	Pin 5 ~ 14, 22
Low level input voltage	V _{IL}	0	-	0.8	V	Pin 5 ~ 14, 22
Input current (Input pull-up terminal)	I _{IL}	50	100	150	μA	Pin 5 ~ 9, VIN = 0V
Input current (Input pull-down terminal)	I _{IH}	30	70	105	μA	Pin 10 ~ 12, 22, VIN = 3.3V
Input current (SCL, SDA terminal)	I _I	-	0	1	μA	Pin 13, 14, VIN = 3.3V
Output current (SCL, SDA terminal)	I _O	-1	0	-	μA	Pin 13, 14, VIN = 0V
High level output voltage (S/PDIF output terminal)	V _{OH}	2.75	3.3	-	V	Pin 23, I _o =-0.6mA
Low level output voltage (S/PDIF output terminal)	V _{OL}	-	0	0.55	V	Pin 23, I _o = 0.6mA
Speaker Output						
Maximum momentary output power 1	P _{O1}	-	10	-	W	THD+n=10%, Gain=26dB *7
Maximum momentary output power 2	P _{O2}	-	20	-	W	Vcc=18V, THD+n=10%, Gain=26dB *7
Total harmonic distortion	THD _{SP}	-	0.07	-	%	P _O =1W, BW=20~20kHz *7
Crosstalk	CT _{SP}	65	80	-	dB	P _O =1W, BW=IHF-A *7
Output noise voltage (Sampling mode)	V _{NO_SP}	-	140	280	μVrms	-∞dBFS, BW=IHF-A *7
Residual noise voltage (Mute mode)	V _{NOR_SP}	-	5	10	μVrms	MUTEX=0V, -∞dBFS, BW=IHF-A *7
PWM sampling frequency	f _{PWM1}	-	512	-	kHz	fs=32kHz *7
	f _{PWM2}	-	705.6	-	kHz	fs=44.1kHz *7
	f _{PWM3}	-	768	-	kHz	fs=48kHz *7
DAC Output						
Maximum output voltage	V _{OMAX}	0.85	1.0	-	Vrms	0dBFS, THD+n=1%
Channel Balance	CB	-1	0	1	dB	0dBFS
Total harmonic distortion	THD _{DA}	-	0.05	0.5	%	-20dBFS, BW=20~20kHz
Crosstalk	CT _{DA}	65	80	-	dB	0dBFS, BW=IHF-A
Output noise voltage	V _{NO_DA}	-	10	20	μVrms	-∞dBFS, BW=IHF-A
Residual noise voltage	V _{NOR_DA}	-	3	10	μVrms	MUTEX=0V, PDX=0V, -∞dBFS, BW=IHF-A

*7 These items show the typical performance of device and depend on board layout, parts, and power supply.
The standard value is in mounting device and parts on surface of ROHM's board directly.

●DSP Block Functional Overview

1) Main Signal line function

No.	Function	Specification	
1	Pre-scalar	<ul style="list-style-type: none"> ·Lch / Rch synchronous control ·+24 ~ -103dB (0.5dB step), -∞dB 	
2	DC cut HPF	<ul style="list-style-type: none"> ·FC : 1Hz 	
3	Channel Mixer	<ul style="list-style-type: none"> ·Mixing of the sound of the left and right channel of the input digital signal to DSP is set up. 	
4	P ² Volume (Perfect Pure Volume)	<ul style="list-style-type: none"> ·There are some scenes when sound becomes large suddenly, like the explosion-scene in TV commercial or in an action movie. The "P2Volume" function controls volume automatically and adjusts the output level. ·It makes easy to hear small whisper voice, and is adjusted. ·Attack time : 1ms ~ 40ms (8steps) ·Recovery time : 0.25s ~ 10s (16 steps) 	
5	BASS	<ul style="list-style-type: none"> ·Peaking filter is used. ·Lch / Rch Concurrent control ·Soft transition function ·Fc Select : Same as 7 Band Parametric Equalizer ·Gain Select : ±18dB (0.5dB step) ·Q (Quality Factor) : Same as 7 Band Parametric Equalizer 	<ul style="list-style-type: none"> ·Low shelf filter is used. ·Lch / Rch Concurrent control ·Soft transition function ·Fc Select : Same as 7 Band Parametric Equalizer ·Gain Select : ±18dB (0.5dB step) ·Q (Quality Factor) : Same as 7 Band Parametric Equalizer
6	MIDDLE	<ul style="list-style-type: none"> ·Peaking filter is used. ·Lch / Rch Concurrent control ·Soft transition function ·Fc Select : Same as 7 Band Parametric Equalizer ·Gain Select : ±18dB (0.5dB step) ·Q (Quality Factor) : Same as 7 Band Parametric Equalizer 	
7	TREBLE	<ul style="list-style-type: none"> ·Peaking filter is used. ·Lch / Rch Concurrent control ·Soft transition function ·Fc Select : Same as 7 Band Parametric Equalizer ·Gain Select : ±18dB (0.5dB step) ·Q (Quality Factor) : Same as 7 Band Parametric Equalizer 	<ul style="list-style-type: none"> ·High shelf filter is used. ·Lch / Rch Concurrent control ·Soft transition function ·Fc Select : Same as 7 Band Parametric Equalizer ·Gain Select : ±18dB (0.5dB step) ·Q (Quality Factor) : Same as 7 Band Parametric Equalizer
8	Scalar 1	<ul style="list-style-type: none"> ·Lch / Rch Concurrent control · +24 ~ -103dB (0.5dB step), -∞dB 	
9	Pseudo Stereo	<ul style="list-style-type: none"> ·A stereo-feel sound is reproduced for a monophonic sound by signal processing. ·3 steps : Pseudo Stereo OFF / Pseudo Stereo ON (Weak) / Pseudo Stereo ON (Strong) 	
10	Matrix Surround 3D	<ul style="list-style-type: none"> ·Matrix Surround 3D of a wider sweet spot, and it also with little prolonged viewing and listening with a feeling of fatigue. ·The acoustic field which does not spoil a vocal feeling of the normal position is played back. ·Surround : ON / OFF function ·Loop : ON / OFF function ·Surround gain select : 16 steps 	
11	P ² Bass (Perfect Pure Bass)	<ul style="list-style-type: none"> ·Clear deep Bass with low distortion. ·Lch / Rch Concurrent control ·Soft transition function ·Frequency select : 4 steps ·Gain select : 0 ~ 15dB (1dB step) 	
12	P ² Treble (Perfect Pure Treble)	<ul style="list-style-type: none"> ·Real, pure and crystal clear sound. ·Lch / Rch Concurrent control ·Soft transition function ·Gain select : 0 ~ 15dB (1dB step) 	
13	Scalar 2	<ul style="list-style-type: none"> ·Lch / Rch Concurrent control ·+24 ~ -103dB (0.5dB step), -∞dB 	

No.	Function	Specification
14	7-Band Parametric Equalizer	<ul style="list-style-type: none"> Peaking filter is used. (Possible to set the 5 coefficients directly for b0,b1,b2,a1,a2) Lch / Rch Concurrent control Fc select : Setup of 61 divisions (20Hz ~ 20kHz) is possible. Gain select : $\pm 18\text{dB}$ (0.5dB step) Q(Quality Factor) : 0.33, 0.43, 0.56, 0.75, 1.0, 1.2, 1.5, 1.8, 2.2, 2.7, 3.3, 3.9, 4.7, 5.6, 6.8, 8.2
15	Volume	<ul style="list-style-type: none"> +24 ~ -103dB (0.5dB step), -∞dB Soft transition and soft mute function Lch / Rch Concurrent control, Sub-Woofer ch Independent control
16	Balance	<ul style="list-style-type: none"> It decreases by 1dB step from a volume setting value. (Lch/Rch : 0dB/-∞dB, 0dB/-126dB, 0dB/-125dB, \dots, 0dB/0dB, \dots, -125dB/0dB, -126dB/0dB, -∞dB/0dB)
17	Post-scaler	<ul style="list-style-type: none"> Lch / Rch Concurrent control, Sub-Woofer ch Independent control +24 ~ -103dB (0.5dB step), -∞dB
18	Output Clipper	<ul style="list-style-type: none"> A clip with an arbitrary output amplitude is possible. Lch / Rch Concurrent control, Sub-Woofer ch Independent control

2) Sub Signal line function

No.	Function	Specification
19	Channel Mixer	<ul style="list-style-type: none"> Mixing of the sound of the left and right channel of the input digital signal to DSP is set up. Lch (Lch is input, (Lch+Rch)/2 is input, Rch is input), Rch (Rch is input, (Lch+Rch)/2 is input, Lch is input)
20	LPF	<ul style="list-style-type: none"> LPF for Sub-Woofer Fc= 60Hz, 80Hz, 100Hz, 120Hz, 160Hz, 200Hz, 240Hz, 280Hz
21	3-Band Parametric Equalizer	<ul style="list-style-type: none"> Peaking or low shelf or high shelf filter is used. Lch / Rch Concurrent control
22	Volume	<ul style="list-style-type: none"> +24 ~ -103dB (0.5dB step), -∞dB Soft transition and soft mute function Lch / Rch Concurrent control, Sub-Woofer ch Independent control
23	Balance	<ul style="list-style-type: none"> It decreases by 1dB step from a volume setting value. (Lch/Rch : 0dB/-∞dB, 0dB/-126dB, 0dB/-125dB, \dots, 0dB/0dB, \dots, -125dB/0dB, -126dB/0dB, -∞dB/0dB)
24	Post-scaler	<ul style="list-style-type: none"> Lch / Rch Concurrent control, Sub-Woofer ch Independent control. +24 ~ -103dB (0.5dB step), -∞dB
25	Output Clipper	<ul style="list-style-type: none"> A clip with an arbitrary output amplitude is possible. Lch / Rch Concurrent control, Sub-Woofer ch Independent control.

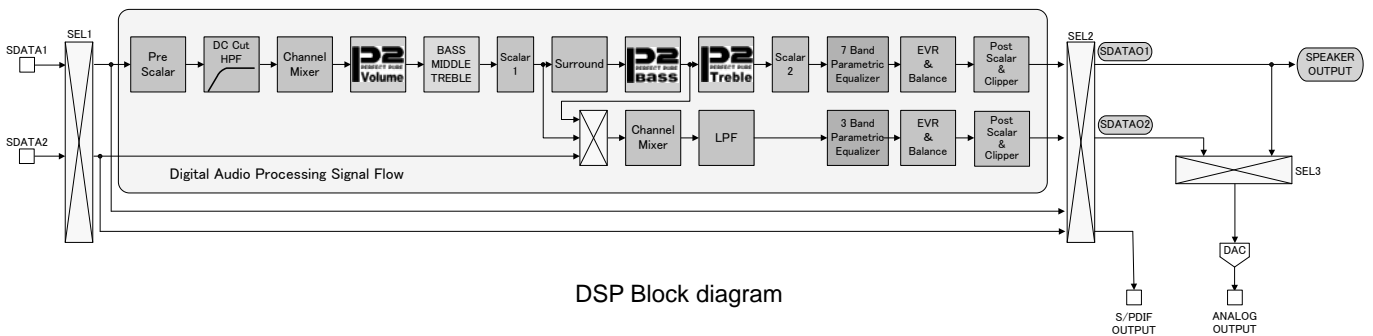

DSP Block diagram

● **Electrical characteristic curves** ($V_{CC}=13V, R_{L_SP}=8\Omega, R_{L_DA}=20k\Omega, Gain=20dB, f_{in}=1kHz, f_s=48kHz$, by passing DSP)
 Measured by ROHM designed 4 layer board.

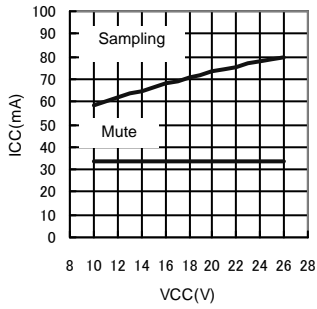

Fig.1

Current consumption
- Power supply voltage

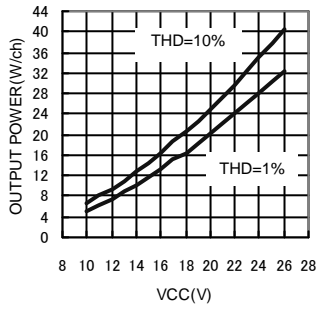

Fig.2

Output power
- Power supply voltage

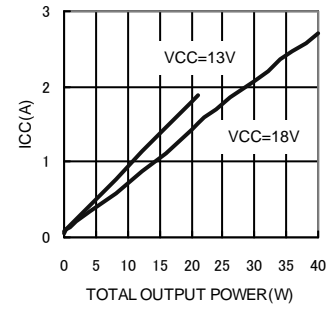

Fig.3

Current consumption
- Output power

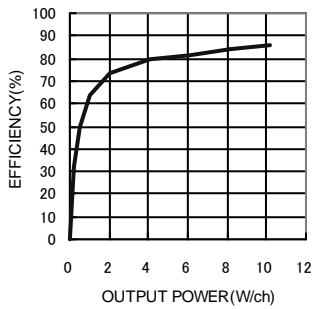

Fig.4

Efficiency - Output power

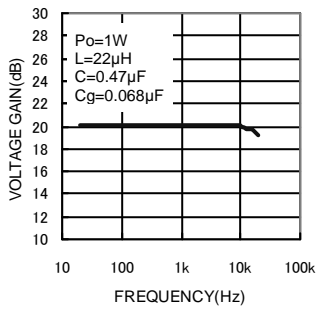

Fig.5

Voltage gain - Frequency

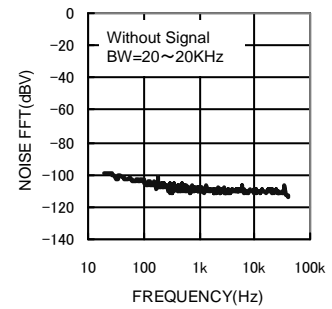

Fig.6

FFT of Output noise voltage

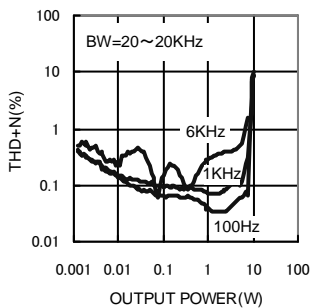

Fig.7

THD+N - Output power

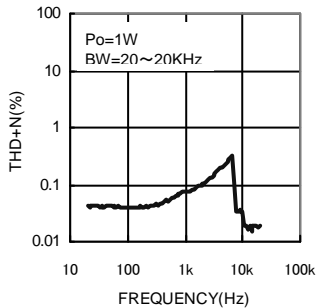

Fig.8

THD+N - Frequency

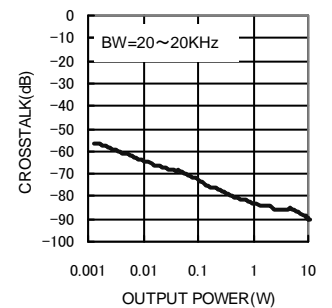

Fig.9

Crosstalk - Output power

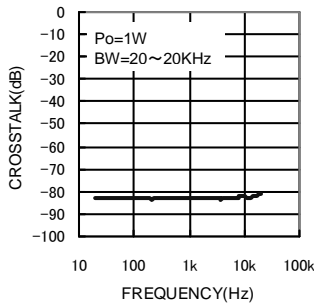

Fig.10

Crosstalk - Frequency

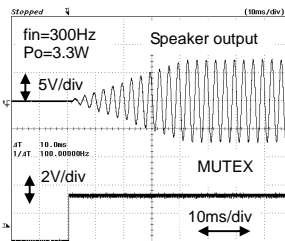

Fig.11

Wave form when
Releasing Soft-start

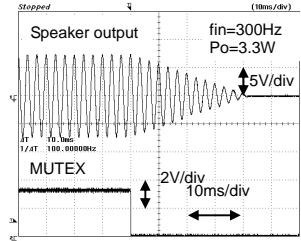

Fig.12

Wave form when
Activating Soft-mute

● **Electrical characteristic curves** ($V_{CC}=18V, R_{L_SP}=8\Omega, R_{L_DA}=20k\Omega, Gain=20dB, f_{in}=1kHz, f_s=48kHz$, by passing DSP)
 Measured by ROHM designed 4 layer board.

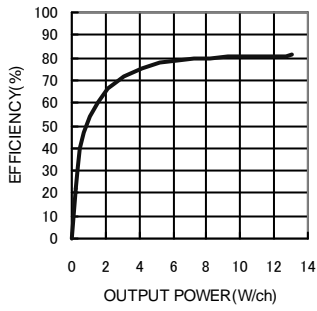

Fig. 13

Efficiency – Output power

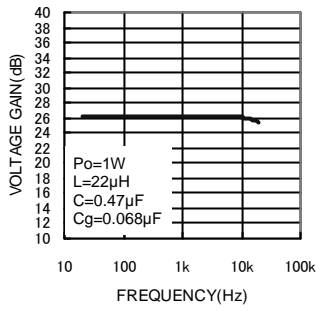

Fig. 14

Voltage gain - Frequency

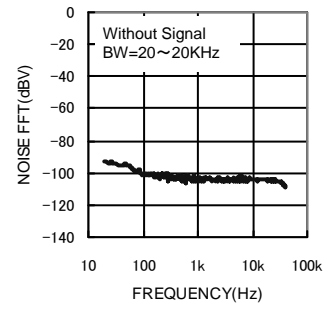

Fig. 15

FFT of output noise voltage

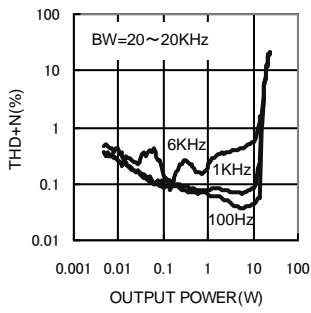

Fig. 16

THD+N - Output power

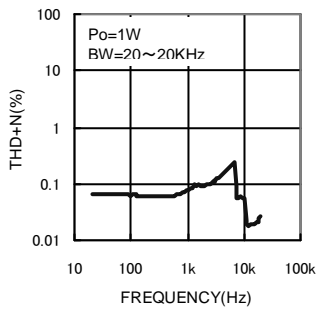

Fig. 17

THD+N - Frequency

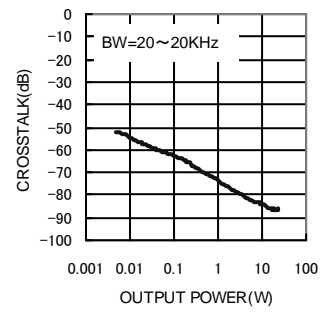

Fig. 18

Crosstalk – Output power

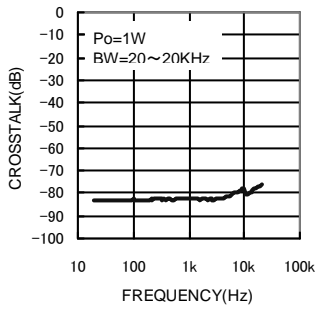
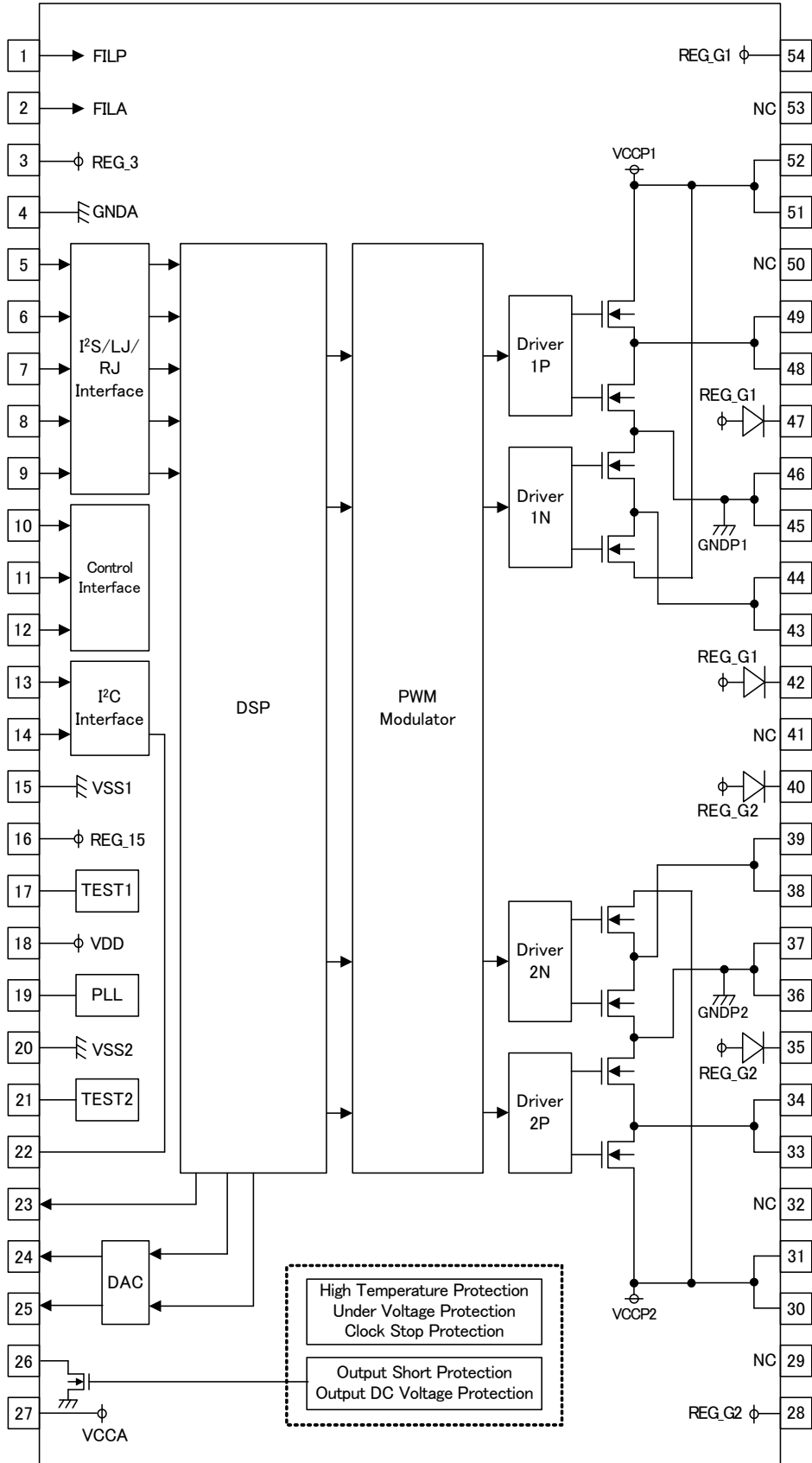

Fig. 19

Crosstalk - Frequency

● Pin configuration and Block diagram



●Pin function explanation (Provided pin voltages are typ. Values)

Pin No.	Pin name	Pin voltage	Pin explanation	Internal equivalence circuit
54 28	REG_G1 REG_G2	5.5V	Internal power supply pin for ch1 Gate driver Internal power supply pin for ch2 Gate driver Please connect the capacitor.	
1	FILP	1.75~2.55V	Bias pin for PWM signal Please connect the capacitor.	
2	FILA	2.5V	Bias pin for Analog signal Please connect the capacitor.	
3	REG3	3.3V	Internal power supply pin for Digital circuit Please connect the capacitor.	
4	GNDA	0V	GND pin for Analog signal	—
5	SYS_CLK	3.3V	System-Clock input pin	
6 7 8 9	BCLK LRCLK SDATA1 SDATA2	3.3V	Digital audio signal input pin	
10	RESETX	0V	Reset pin for Digital circuit H: Reset OFF L: Reset ON	
11	MUTEX		Speaker output mute control pin H: Mute OFF L: Mute ON	
12	PDX		Power down control pin H: Power down OFF L: Power down ON	

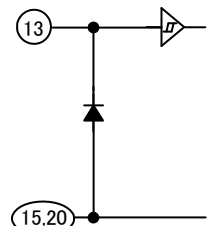
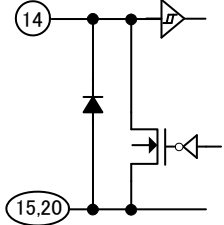
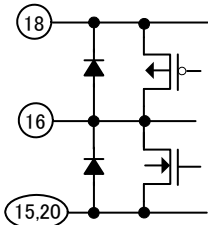
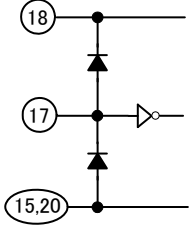
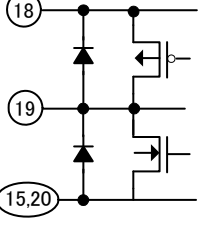
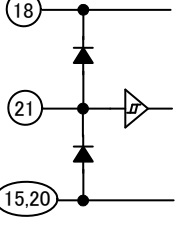
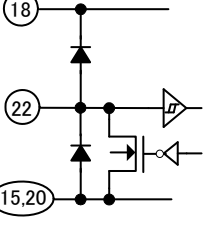
Pin No.	Pin name	Pin voltage	Pin explanation	Internal equivalence circuit
13	SCL	—	I ² C transmit clock input pin	
14	SDA	—	I ² C data input/output pin	
15 20	VSS1 VSS2	0V	GND pin for Digital I/O	—
16	REG_15	1.5V	Internal power supply pin for Digital circuit	
17	TEST1	—	Test pin Please connect to VSS.	
18	VDD	3.3V	Power supply pin for Digital I/O	—
19	PLL	1V	PLL's filter pin	
21	TEST2	0V	Test pin Please connect to VSS.	
22	ADDR	0V	I ² C Slave address select pin	

Pin No.	Pin name	Pin voltage	Pin explanation	Internal equivalence circuit
23	OUT_SPDIF	—	S/PDIF output pin	
24 25	OUT_DAC2 OUT_DAC1	2.5V	ch2 DAC output pin ch1 DAC output pin Please connect it with the latter part circuit through the capacitor.	
26	ERROR	3.3V	Error flag pin Please connect pull-up resistor. H: While Normal L: While Error	
27	VCCA	Vcc	Power supply pin for Analog signal	—
30 31	VCCP2	Vcc	Power supply pin for ch2 PWM signal	
33 34	OUT2P	Vcc~0V	Output pin of ch2 positive PWM signal Please connect to Output LPF.	
35	BSP2P	—	Boot-strap pin of ch2 positive Please connect the capacitor.	
36 37	GNDP2	0V	GND pin for ch2 PWM signal	
38 39	OUT2N	Vcc~0V	Output pin of ch2 negative PWM signal Please connect to Output LPF.	
40	BSP2N	—	Boot-strap pin of ch2 negative Please connect the capacitor.	
42	BSP1N	—	Boot-strap pin of ch1 negative Please connect the capacitor.	
43 44	OUT1N	Vcc~0V	Output pin of ch1 negative PWM signal Please connect to Output LPF.	
45 46	GNDP1	0V	GND pin for ch1 PWM signal	
47	BSP1P	—	Boot-strap pin of ch1 positive Please connect the capacitor.	
48 49	OUT1P	Vcc~0V	Output pin of ch1 positive PWM signal Please connect to Output LPF.	
51 52	VCCP1	—	Power supply pin for ch1 PWM signal	
29 32 41 50 53	N.C.	—	Non connection pin	—

●RESETX pin function

RESETX (10pin)	State of Digital block
L	Reset ON
H	Reset OFF

●PDX pin,MUTEX pin function

PDX (12pin)	MUTEX (11pin)	Power Down	DAC output (24,25pin)	PWM output (33,34,38,39,43,44,48pin)
L	L or H	ON	HiZ_Low	HiZ_Low
H	L	OFF	Normal operation	
H	H			Normal operation

●Input digital audio sampling frequency (fs) explanation

PWM sampling frequency, Soft-start, Soft-mute time, and the detection time of the DC voltage protection in the speaker depends on sampling frequency (fs) of the digital audio input.

Sampling frequency of the Digital audio input (fs)	PWM sampling frequency (fpwm)	Soft-start / Soft-mute time	DC voltage protection in the speaker detection time
32kHz	512kHz	64msec.	64msec.
44.1kHz	705.6kHz	46msec.	46msec.
48kHz	768kHz	43msec.	43msec.

●For voltage gain (Gain setting)

BM5446EFV prescribe voltage gain at speaker output (BTL output) under the definition 0dBV (1Vrms) as full scale input of the digital audio input signal. For example, digital audio input signal = Full scale input, Gain setting = 20dB, Load resistance $R_{L_SP} = 8\Omega$ will give speaker output (BTL output) amplitude as 10Vrms. (Output power $P_o = V_o^2/R_{L_SP} = 12.5W$)

●Speaker output

DSP output signal SDATAO1 will be output to the speaker. (SDATAO2 will not be output to the speaker. DAC output can be selected either from DSP output signal SDATAO1 or SDATAO2.)

● I²C Bus control signal specification

1) Electrical characteristics and Timing of Bus line and I/O stage

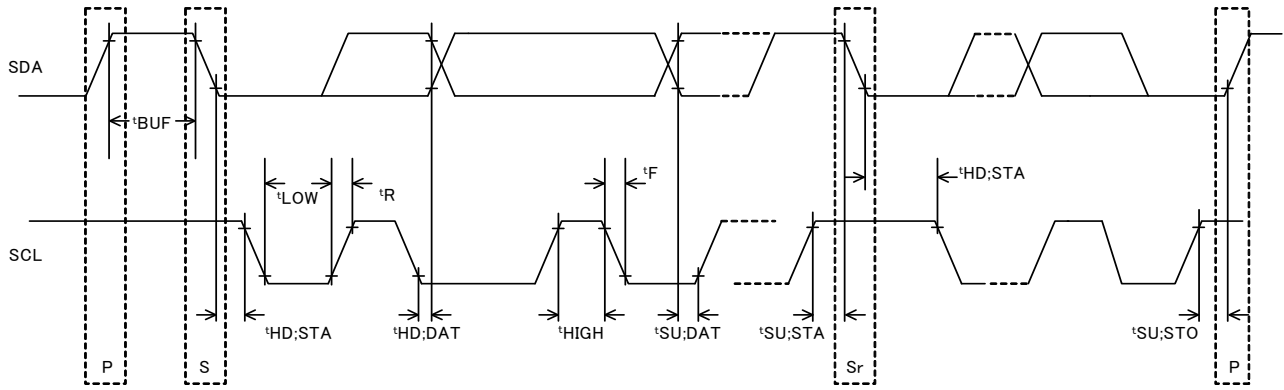

SDA and SCL bus line characteristics (Unless otherwise specified Ta=25°C, V_{CC}=13V)

Parameter	Symbol	High speed mode		Unit
		Min.	Max.	
1 SCL clock frequency	f _{SCL}	0	400	kHz
2 Bus free time between "Stop" condition and "Start" condition	t _{BUF}	1.3	-	μs
3 Hold-time of (sending again) "Start" condition. After this period the first clock pulse is generated.	t _{HD;STA}	0.6	-	μs
4 SCL clock's LOW state Hold-time	t _{LOW}	1.3	-	μs
5 SCL clock's HIGH state Hold-time	t _{HIGH}	0.6	-	μs
6 Set-up time of sending again "Start" condition	t _{SU;STA}	0.6	-	μs
7 Data hold time	t _{HD;DAT}	0 ^{*1}	-	μs
8 Data set-up time ^{*2}	t _{SU;DAT}	500/250/150	-	ns
9 Rise-time of SDA and SCL signal	t _R	20+C _b	300	ns
10 Fall-time of SDA and SCL signal	t _F	20+C _b	300	ns
11 Set-up time of "Stop" condition	t _{SU;STO}	0.6	-	μs
12 Capacitive load of each bus line	C _b	-	400	pF

The above-mentioned numerical values are all the values corresponding to VIH min and the VIL max level.

*1 To exceed an undefined area on the fall-edge of SCL (VIH min of the SCL signal), the transmitting set should internally offer the holding time of 300ns or more for the SDA signal.

*2 The data set-up time is different according to the setting of SYS_CLK.

When SYS_CLK=128fs it is 500ns, for SYS_CLK=256fs it is 250ns, for SYS_CLK=512fs it will be 150ns.

*3 SCL and SDA pin is not corresponding to threshold tolerance of 5V.

Please use it within 4.5V of the absolute maximum rating.

2) Command interface

I²C Bus control is used for command interface between host CPU. It not only writes but also it is possible to read it excluding a part of register. In addition to "Slave Address", set and write 1 byte of "Select Address" to read out the data. I²C bus Slave mode format is illustrated below.

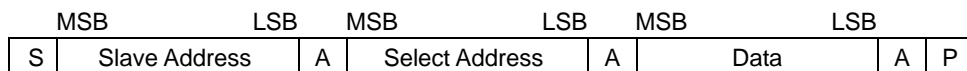

S : Start Condition

Slave Address : The data of eight bits in total is sent putting up bit of Read mode (H) or Write mode (L) after slave address (7bit) set with the terminal ADDR. (MSB first)

A : The acknowledge bit adds to data that the acknowledge is sent and received in each byte. When data is correctly sent and received, "L" is sent and received. There was no acknowledgement for "H".

Select Address : The select address in one byte is used. (MSB first)

Data : Data byte is sent and received data (MSB first)

P : Stop Condition

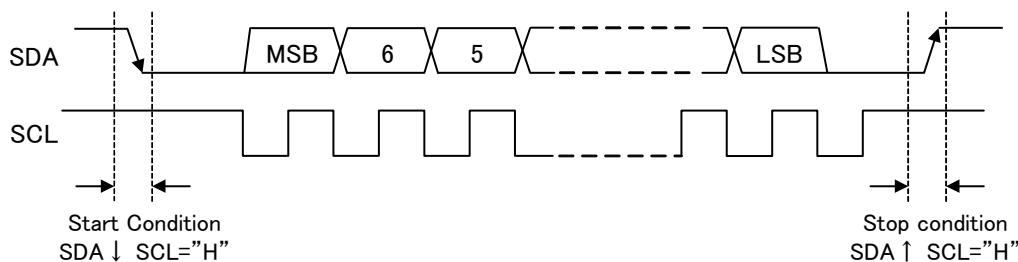

3) Slave Address

- While ADDR pin (22pin) is“L”

MSB							LSB
A6	A5	A4	A3	A2	A1	A0	R/W
1	0	0	0	0	0	0	1/0

- While ADDR pin (22pin) is“H”

MSB							LSB
A6	A5	A4	A3	A2	A1	A0	R/W
1	0	0	0	0	0	1	1/0

4) Writing of data

- Basic format

S	Slave Address	A	Select Address	A	Data	A	P
---	---------------	---	----------------	---	------	---	---

: Master to Slave, : Slave to Master

- Auto-increment format

S	Slave Address	A	Select Address	A	Data 1	A	Data 2	A	Data 3...N	A	P
---	---------------	---	----------------	---	--------	---	--------	---	------------	---	---

: Master to Slave, : Slave to Master

5) Reading of data

First of all, the address (20h in the example) for reading is written in the register of the D0h address at the time of reading. In the following stream, data is read after the slave address. Please do not return the acknowledge when you end the reception.

S	Slave Address	A	Req_Addr	A	Select Address	A	P
---	---------------	---	----------	---	----------------	---	---

(ex.) 80h D0h 20h

S	Slave Address	A	Data 1	A	Data 2	A	A	Data N	Ā	P
---	---------------	---	--------	---	--------	---	-------	---	--------	---	---

(ex.) 81h **h **h **h

: Master to Slave, : Slave to Master, A : With Acknowledge, Ā : Without Acknowledge

6) Instruction Code Chart (Select Address)

MSB \ LSB		0	1	2	3	4	5	6	7
0	I/O Setting CLK Setting		RAM Clear		Input SEL S-P2,S-P1	Output SEL P-S2,P-S1	SPDIFO Output SEL		
1	SPDIF	MUTE Setting	SPDIF OUT Setting1	SPDIF OUT Setting2	SPDIF OUT				
2	DSP Volume	PRE Scaler Setting	DC Cut HPF	CH Mixer1 DSP	CH Mixer2 DF2, DF1	Scaler1 Setting	Scaler2 Setting	Main Volume Setting	Main Balance Setting
3	Sub Clipper P ² Volume	Sub Clipper ON/OFF	Sub Clipper Setting1	Sub Clipper Setting2	P ² V Setting1	P ² V_MIN	P ² V_MAX	P ² V_K	P ² V_OFS
4	DSP TONE	BASS Control	BASS Frequency	BASS Quality factor	BASS Gain	MIDDLE Control	MIDDLE Frequency	MIDDLE Quality factor	MIDDLE Gain
5	DSP 7BandP-EQ	7Band1 Control	7Band1 Frequency	7Band1 Quality factor	7Band1 Gain	7Band2 Control	7Band2 Frequency	7Band2 Quality factor	7Band2 Gain
6	DSP 7BandP-EQ	7Band5 Control	7Band5 Frequency	7Band5 Quality factor	7Band5 Gain	7Band6 Control	7Band6 Frequency	7Band6 Quality factor	7Band6 Gain
7	DSP Sound Effect	Surround Setting	Pseudo Stereo	P ² Bass Setting1	P ² Bass Setting2	P ² Bass Setting3	P ² Treble Setting1	P ² Treble Setting2	P ² Bass Soft_T Start
8	DSP 3BandP-EQ	3Band1 Control	3Band1 Frequency	3Band1 Quality factor	3Band1 Gain	3Band2 Control	3Band2 Frequency	3Band2 Quality factor	3Band2 Gain
9									
A	PLLA	PLLA Setting1						Sync Detect1	Sync Detect2
B	Power Stage	Power Stage Gain	Power Stage Test1	Power Stage Test2	Power Stage Test3	Power Stage Test4	Power Stage Test5	Power Stage Test6	Power Stage Test7
C									
D	Read Base Address	Read Base Address							
E									
F	TEST Mode	PU Setting	Initial Setting TEST Mode1	TEST Mode2	MCLK DIV Setting	PLLA Initial Setting1	PLLA Initial Setting2	PLLA Initial Setting3	PLLA Initial Setting4

MSB \ LSB		8	9	A	B	C	D	E	F
0	I/O Setting CLK Setting	SYSCLK SEL1 DSP			I ² S Format1 S-P1	I ² S Format2 S-P2	I ² S Format3 P-S1	I ² S Format4 P-S2	
1	SPDIF								
2	DSP Volume	Main Post Scalar Setting	Main Clipper ON/OFF	Main Clipper Setting1	Main Clipper Setting2	Sub Volume Setting	Sub Balance Setting	Sub Post Scalar Setting	Sub Input Selector
3	P ² Volume	A_RATE R_RATE	A_TIME R_TIME	A_RATE_Low R_RATE_Low	AR_TIME_ Low	Pulse Sound Setting1			
4	DSP TONE	TREBLE Control	TREBLE Frequency	TREBLE Quality factor	TREBLE Gain	TONE Control Soft_T Start			
5	DSP 7Band P-EQ	7Band3 Control	7Band3 Frequency	7Band3 Quality factor	7Band3 Gain	7Band4 Control	7Band4 Frequency	7Band4 Quality factor	7Band4 Gain
6	DSP 7Band P-EQ	7Band7 Control	7Band7 Frequency	7Band7 Quality factor	7Band7 Gain		CRAM Auto Over Write	CRAM Auto Setting1	CRAM Auto Setting2
7	DSP Sound Effect	P ² Treble Soft_T Start		Sub Woofer LPF Setting					
8	DSP 3BandP-EQ	3Band3 Control	3Band3 Frequency	3Band3 Quality factor	3Band3 Gain	P-EQ Setting1	P-EQ Setting2	P-EQ Setting3	P-EQ Setting4
9									
A	PLLA	Sync Detect3	Sync Detect4						
B	Power Stage	C2D speed	Refresh	Test8					
C									
D	Read Base Address								
E									
F	TEST Mode	RAM Test Setting1	RAM Test Setting2	RAM Test Setting3	RAM Test Setting4	RAM Test Setting5	DSP Mute Set		

● **Format of digital audio input**

- **SYS_CLK:** It is System Clock input signal.
It will input LRCLK, BCLK, SDATA1 (SDATA2) that synchronizes with this clock that are 128 times of sampling frequency (128fs), 256 times of sampling frequency (256fs), or 512 times frequency (512fs) of sampling frequency (fs).
- **LRCLK:** It is L/R clock input signal.
It corresponds to 32kHz/44.1kHz/48kHz with those clock (fs) that are same to the sampling frequency (fs) .
The audio data of a left channel and a right channel for one sample is input to this section.
- **BCLK:** It is Bit Clock input signal.
It is used for the latch of data in every one bit by sampling frequency's 48 times frequency (48fs) or 64 times sampling frequency (64fs). However if the 48fs being selected, the input will be Right-justified data format and held static.
- **SDATA1 & SDATA2:** It is Data input signal.
It is amplitude data. The data length is different according to the resolution of the input digital data.
It corresponds to 16/ 20/ 24 bit.

The digital input has I2S, Left-justified and Right-justified formats.
The figure below shows the timing chart of each transmission mode.

I²S data format

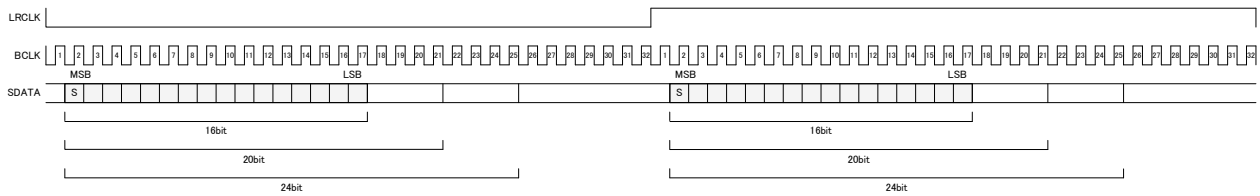

Left-justified data format

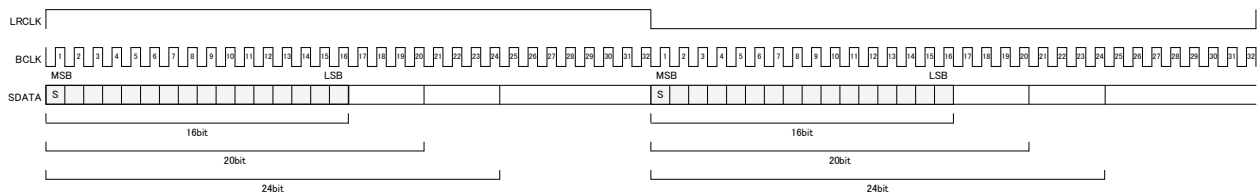

Right-justified data format

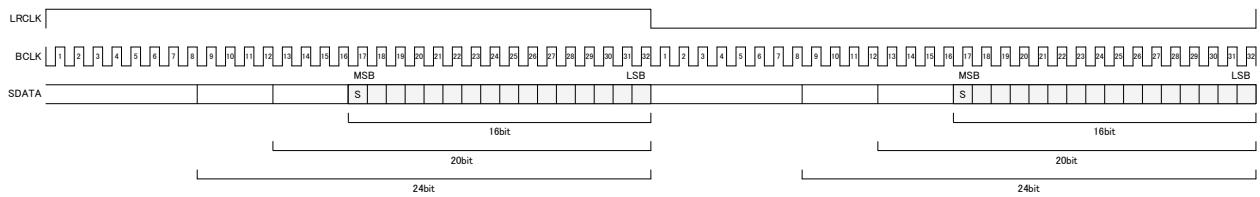

Right-justified data format (48fs)

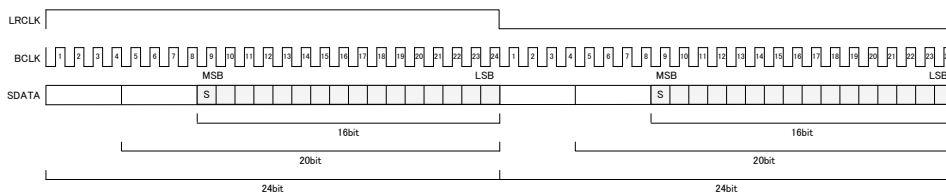

● Power supply start-up sequence

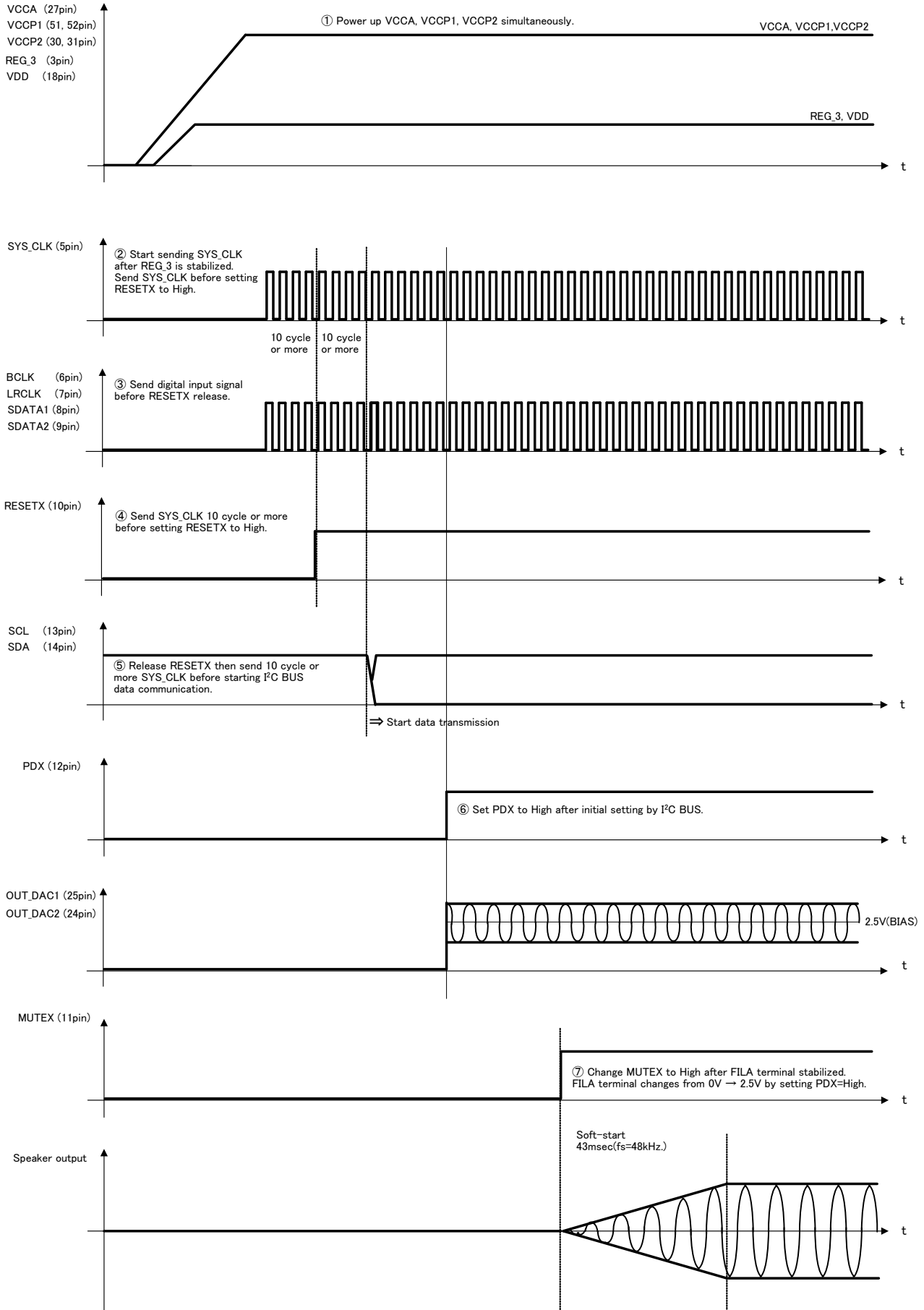

● Power supply shut-down sequence

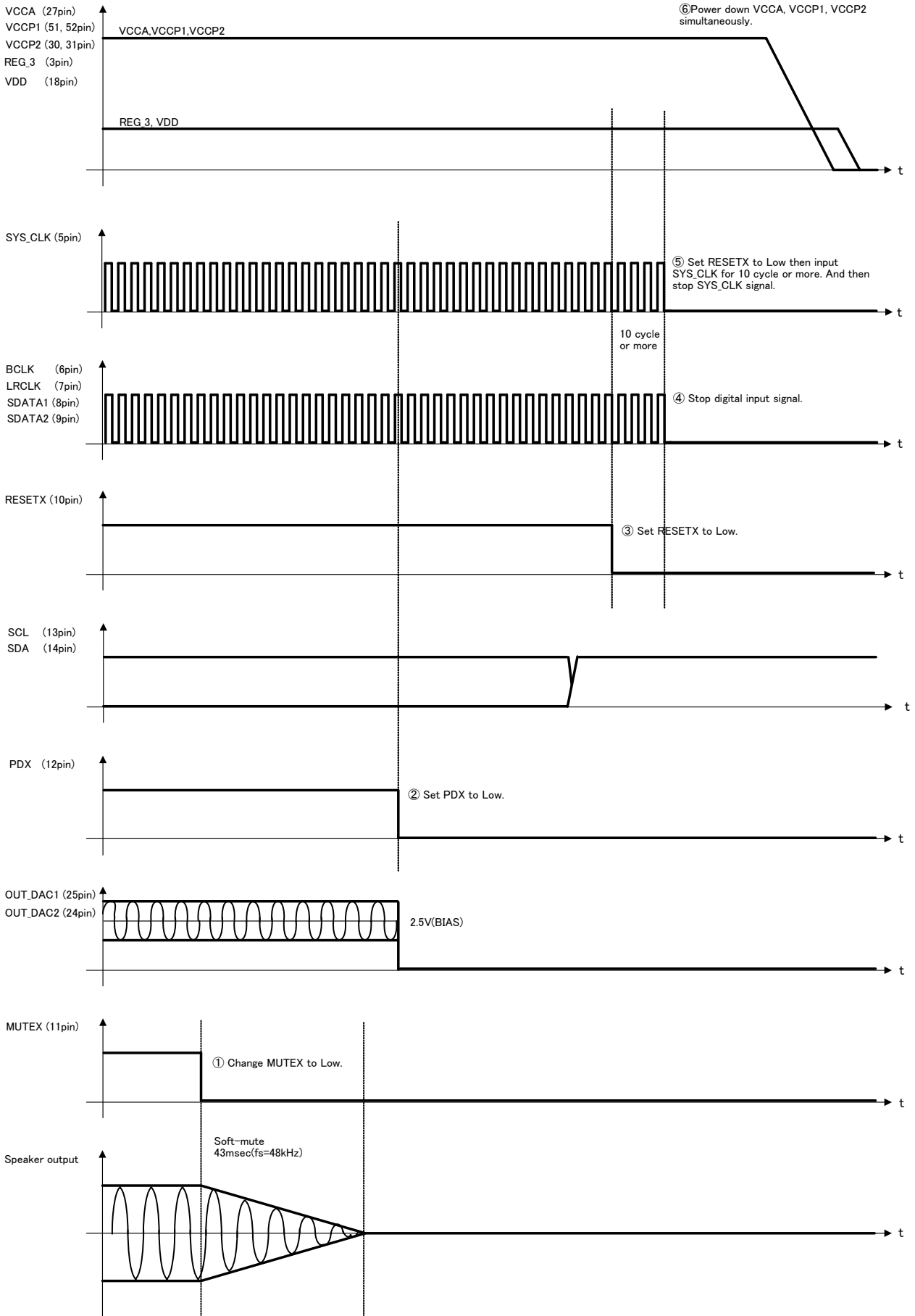

●About the protection function

Protection function	Detecting & Releasing condition		DAC Output	PWM Output	ERROR Output
Output short protection	Detecting condition	Detecting current = 10A (TYP.)	Normal operation	HiZ_Low (Latch)	L (Latch)
DC voltage protection in the speaker	Detecting condition	PWM output Duty=0% or 100% 43msec(fs=48kHz) above fixed		HiZ_Low (Latch)	L (Latch)
High temperature protection	Detecting condition	Chip temperature to be above 150°C (TYP.)	Normal operation	HiZ_Low	H
	Releasing condition	Chip temperature to be below 120°C (TYP.)		Normal operation	
Under voltage protection	Detecting condition	Power supply voltage to be below 8V (TYP.)	Normal operation	HiZ_Low	H
	Releasing condition	Power supply voltage to be above 9V (TYP.)		Normal operation	
Clock stop protection	Detecting condition	No change to SYS_CLK more than 1usec (TYP.)	Irregular output	HiZ_Low	H
	Releasing condition	Input to SYS_CLK	Normal operation	Normal operation	

1) Output short protection(Short to the power supply)

This IC has the output short protection circuit that stops the PWM output when the PWM output is short-circuited to the power supply due to abnormality.

Detecting condition - It will detect when MUTE pin is set High and the current that flows in the PWM output pin becomes 10A(TYP.) or more. The PWM output instantaneously enters the state of HiZ-Low if detected, and IC does the latch.

Releasing method - ①After the MUTE pin is set Low once, the MUTE pin is set High again.
 ②Turning on the power supply again.

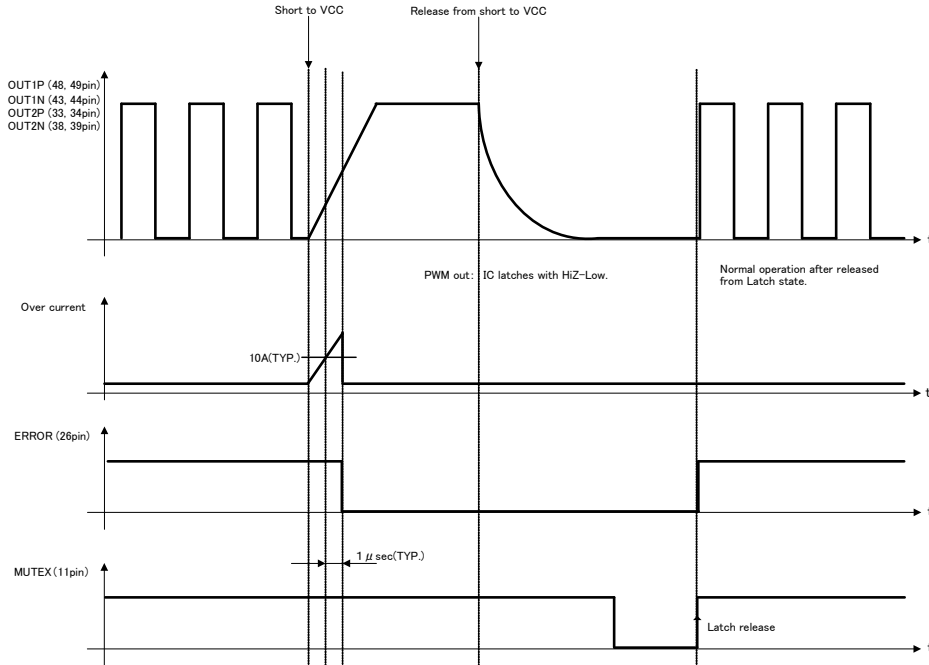

2) Output short protection(Short to GND)

BM5446EFV has the output short protection circuit that stops the PWM output when the PWM output is short-circuited to GND due to abnormality.

Detecting condition - It will detect when MUTE pin is set High and the current that flows in the PWM output terminal becomes 10A(TYP.) or more. The PWM output instantaneously enters the state of HiZ-Low if detected, and IC does the latch.

Releasing method – ①After the MUTE pin is set Low once, the MUTE pin is set High again.
 ②Turning on the power supply again.

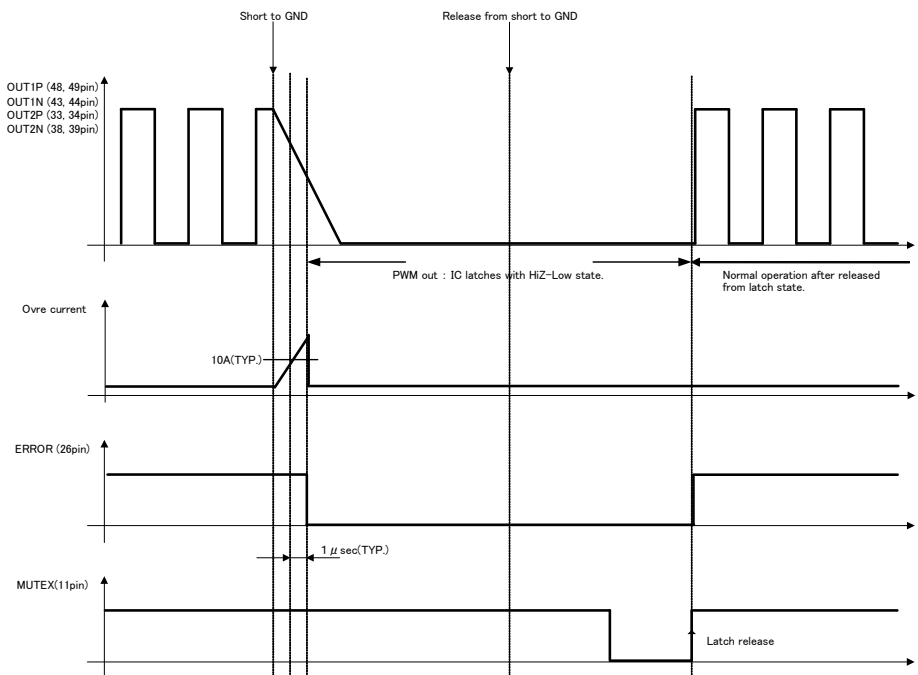

3) DC voltage protection in the speaker

When the DC voltage in the speaker is impressed due to abnormality, this IC has the protection circuit where the speaker is defended from destruction.

Detecting condition - It will detect when MUTE pin is set High and PWM output Duty=0% or 100% , 43msec(fs=48kHz) or above. Once detected, The PWM output instantaneously enters the state of HiZ-Low, and IC does the latch.

Releasing method – ①After the MUTE pin is set Low once, the MUTE pin is set High again.
 ②Turning on the power supply again

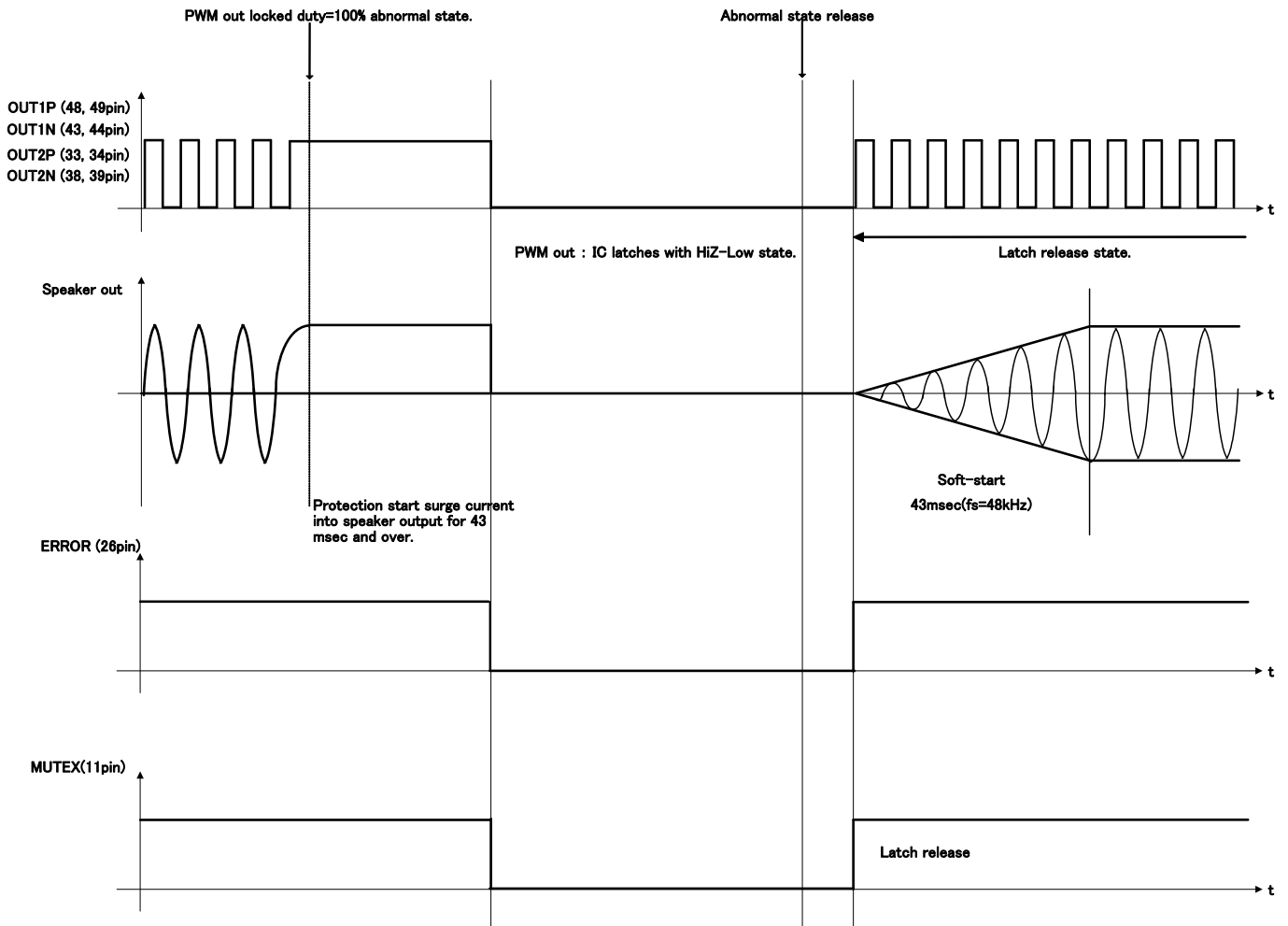

4) High temperature protection

BM5446EFV has the high temperature protection circuit that prevents thermal reckless driving under an abnormal state for the temperature of the chip to exceed $T_{jmax}=150^{\circ}\text{C}$.

Detecting condition - It will detect when MUTE pin is set High and the temperature of the chip becomes 150°C (TYP.) or more. The speaker output is muted through a soft-mute when detected.

Releasing condition - It will release when MUTE pin is set High and the temperature of the chip becomes 120°C (TYP.) or less. The speaker output is outputted through a soft-start when released.

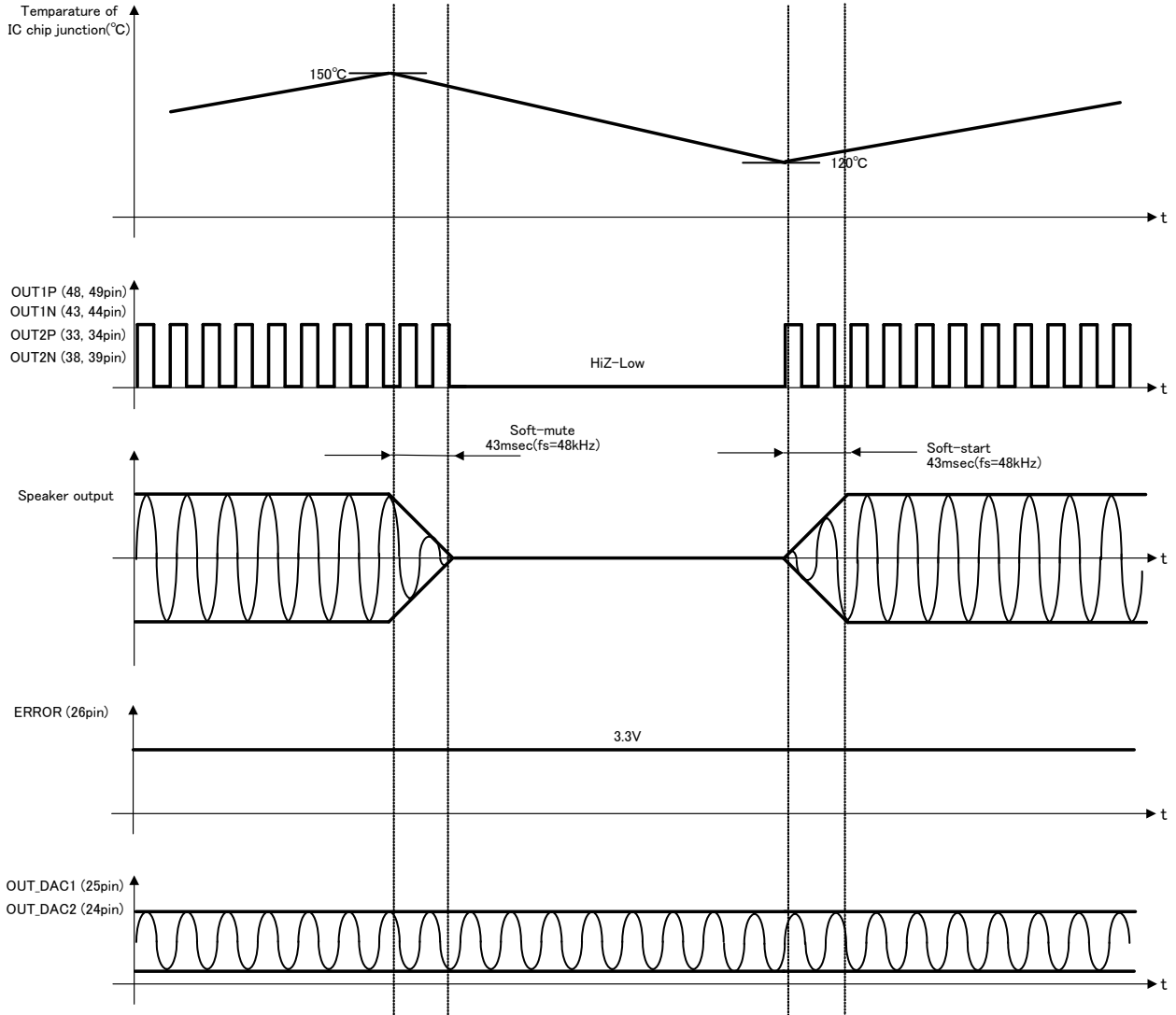

5) Under voltage protection

BM5446EFV has the under voltage protection circuit that make speaker output mute once detecting extreme drop of the power supply voltage.

Detecting condition – It will detect when MUTE pin is set High and the power supply voltage becomes lower than 8V.
The speaker output is muted through a soft-mute when detected.

Releasing condition – It will release when MUTE pin is set High and the power supply voltage becomes more than 9V.
The speaker output is outputted through a soft-start when released.

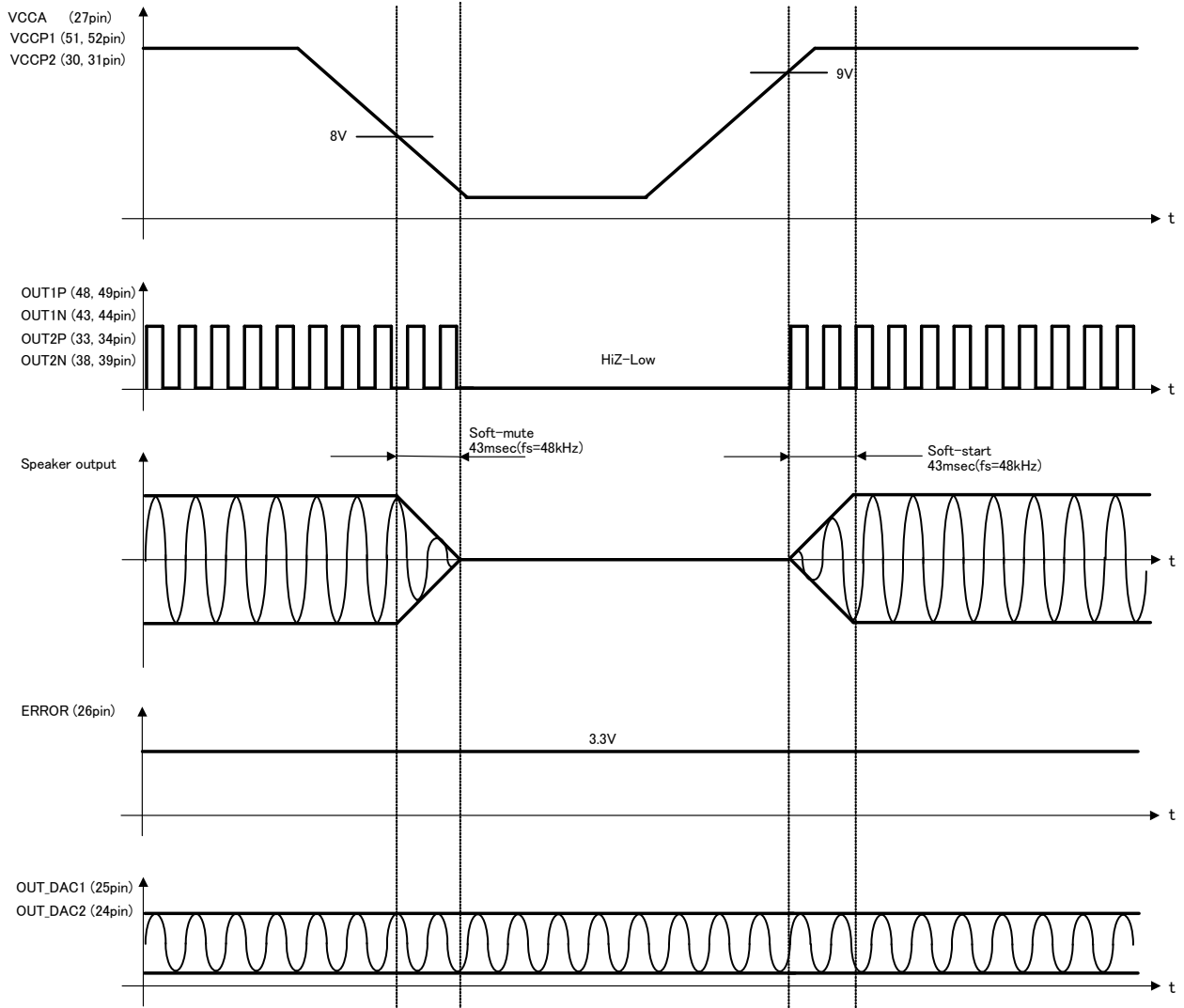

6) Clock stop protection

BM5446EFV has the clock stop protection circuit that make the speaker output mute when the SYS_CLK signal of the digital audio input stops.

Detecting condition - It will detect when MUTE pin is set High and the SYS_CLK signal doesn't change for about 1usec or more. The speaker output is muted through a soft-mute when detected.

Releasing condition - It will release when MUTE pin is set High and the SYS_CLK signal returns to the normal clock operation. The speaker output is outputted through a soft-start when released.

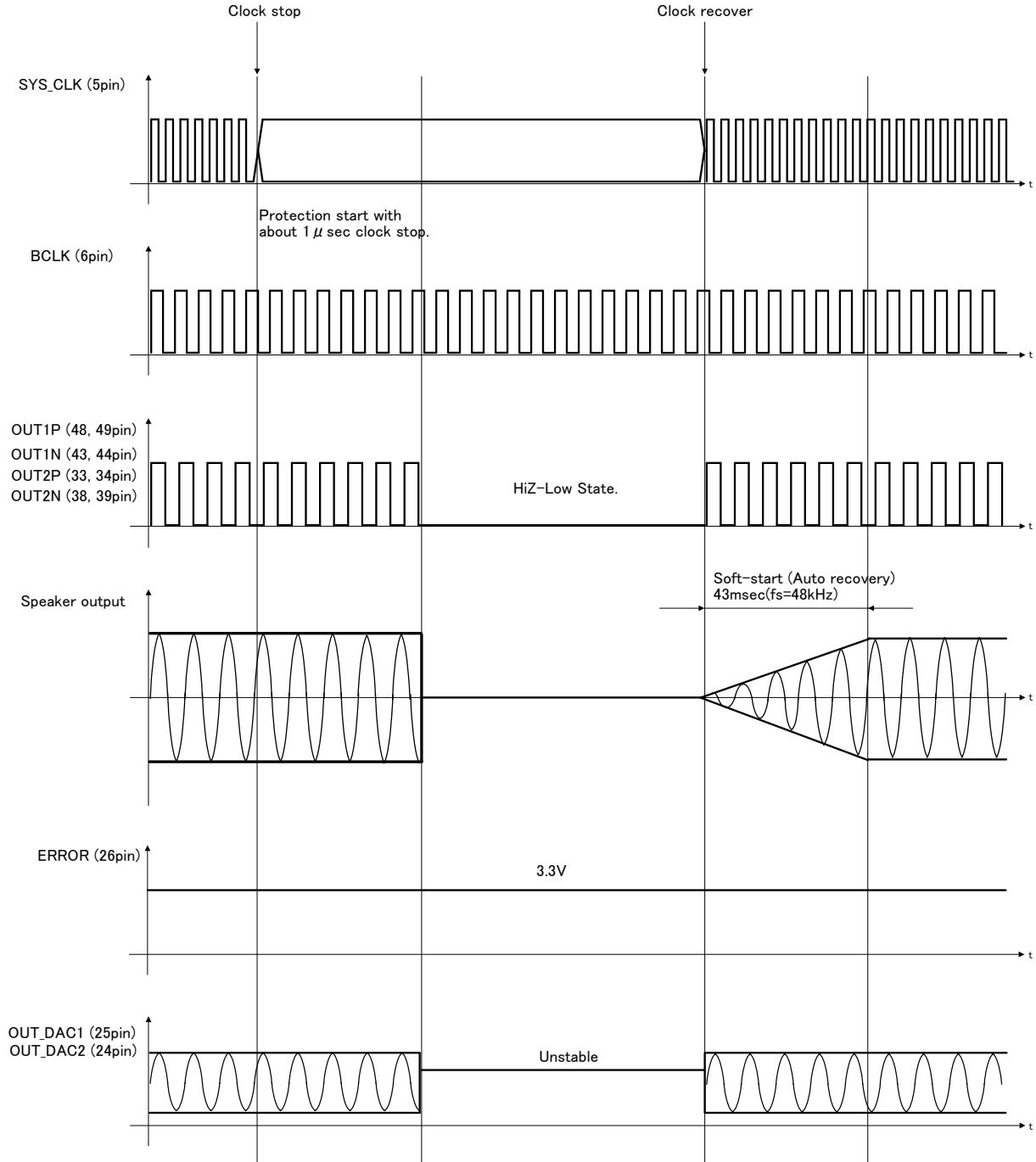

● Application Circuit Example (RL_SP=8Ω)

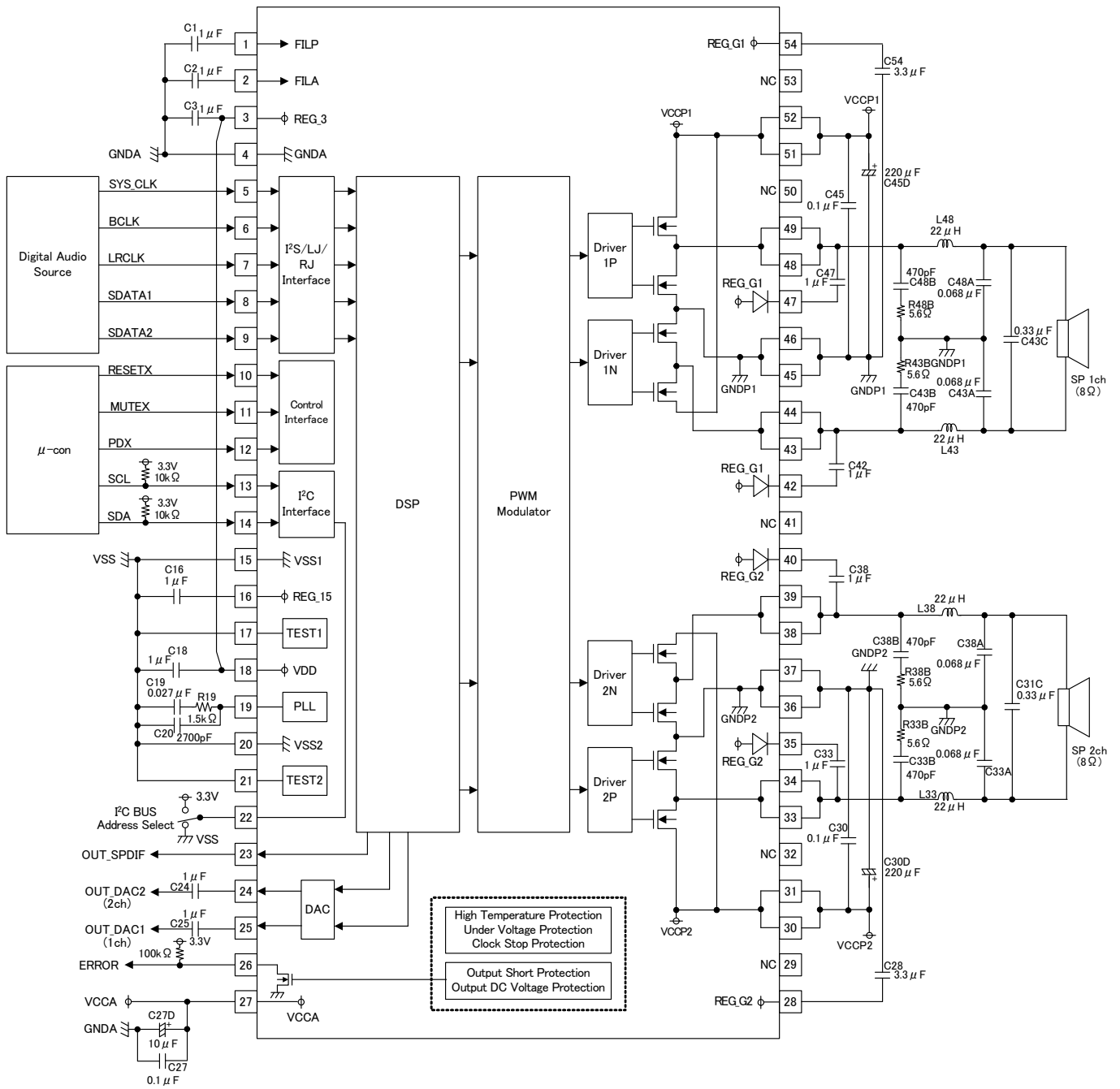

●BOM list(RL_SP =8Ω)

Parts	Parts No.	Value	Company	Product No.	Rated Voltage	Tolerance	Size
IC	U1	-	ROHM	BM5446EFV	-	-	18.5mm×9.5mm
Inductor	L33, L38, L43, L48	22μH	TOKO	1168ER-0001	-	(±20%)	10.3mm×7.6mm
			SAGAMI	DBE7210H-220M	-	(±20%)	10.5mm×6.4mm
Resistor	R33B, R38B R43B, R48B	5.6Ω	ROHM	MCR18PZHFL5R60	1/4W	F(±1%)	3.2mm×1.6mm
	R19	1.5kΩ		MCR01MZPF1501	-	-	1.0mm×0.5mm
Capacitor	C33, C38, C42, C47	1μF	MURATA	GRM185B31C105KE43	16V	B(±10%)	1.6mm×0.8mm
	C27, C30, C45	0.1μF		GRM188B31H104KA92	50V	B(±10%)	1.6mm×0.8mm
	C33A, C38A C43A, C48A	0.068μF		GRM21BB11H683KA01	50V	B(±10%)	2.0mm×1.25mm
	C31C, C43C	0.33μF		GRM219B31H334KA87	50V	B(±10%)	2.0mm×1.25mm
	C28, C54	3.3μF		GRM188B31A335KE15	10V	B(±10%)	1.6mm×0.8mm
	C1, C2, C3 C16, C18, C25, C24	1μF		GRM185B30J105KE25	6.3V	B(±10%)	1.6mm×0.8mm
	C33B, C38B C43B, C48B	470pF		GRM188B11H471KA	50V	B(±10%)	2.0mm×1.2mm
	C19	0.027μF		GRM188B11C273KA01	16V	B(±10%)	1.6mm×0.8mm
	C20	2700pF		GRM188B11E272KA01	25V	B(±10%)	1.6mm×0.8mm
Electrolytic Capacitor	C30D, C45D	220μF	Panasonic	ECA1VMH221	35V	±20%	φ8mm×11.5mm
	C27D	10μF		EEUFC1H100L	50V	±20%	φ5mm×11mm

● Application Circuit Example (RL_SP = 6 Ω)

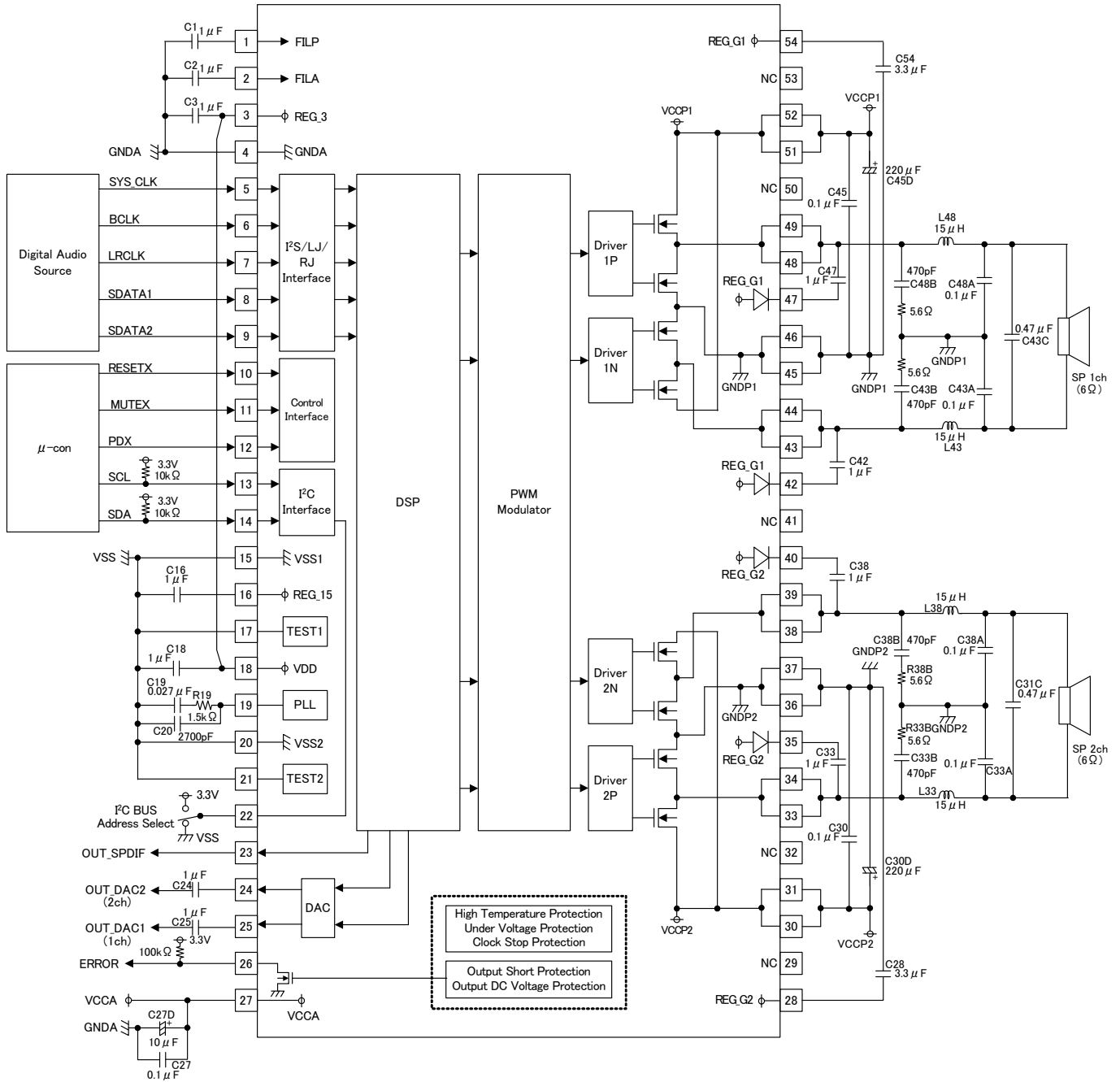

●BOM list(RL_SP =6Ω)

Parts	Parts No.	Value	Company	Product No.	Rated Voltage	Tolerance	Size
IC	U1	—	ROHM	BM5446EFV	—	—	18.5mm×9.5mm
Inductor	L33, L38, L43, L48	15μH	SAGAMI	DBE7210H-150M	—	(±20%)	10.5mm×6.4mm
Resistor	R33B, R38B R43B, R48B	5.6Ω	ROHM	MCR18PZHFL5R60	1/4W	F(±1%)	3.2mm×1.6mm
	R19	1.5kΩ		MCR01MZPF1501			1.0mm×0.5mm
Capacitor	C33, C38, C42, C47	1μF	MURATA	GRM185B31C105KE43	16V	B(±10%)	1.6mm×0.8mm
	C27, C30, C45, C33A, C38A, C43A, C48A	0.1μF		GRM188B31H104KA92	50V	B(±10%)	1.6mm×0.8mm
	C31C, C43C	0.47μF		GRM21BB31H474KA87	50V	B(±10%)	2.0mm×1.2mm
	C28, C54	3.3μF		GRM188B31A335KE15	10V	B(±10%)	1.6mm×0.8mm
	C1, C2, C3 C16, C18, C25, C24	1μF		GRM185B30J105KE25	6.3V	B(±10%)	1.6mm×0.8mm
	C33B, C38B C43B, C48B	470pF		GRM188B11H471KA	50V	B(±10%)	2.0mm×1.2mm
	C19	0.027μF		GRM188B11C273KA01	16V	B(±10%)	1.6mm×0.8mm
	C20	2700pF		GRM188B11E272KA01	25V	B(±10%)	1.6mm×0.8mm
Electrolytic Capacitor	C30D, C45D	220μF	Panasonic	ECA1VMH221	35V	±20%	φ8mm×11.5mm
	C27D	10μF		EEUFC1H100L	50V	±20%	φ5mm×11mm

●Output LC Filter Circuit

An output filter is required to eliminate radio-frequency components exceeding the audio-frequency region supplied to a load (speaker). Because this IC uses sampling clock frequencies from 200kHz to 400kHz in the output PWM signals, the high-frequency components must be appropriately removed.

This section takes an example of an LC type LPF shown in Fig.12, in which coil L and capacitor C compose a differential filter with an attenuation property of -12dB/oct. A large part of switching currents flow to capacitor C, and only a small part of the currents flow to speaker R_L . This filter reduces unwanted emission this way. In addition, coil L and capacitor C_g compose a filter against in-phase components, reducing unwanted emission further.

Filter constants depend on load impedances. The following are formulas to calculate values of L, C, and C_g when $Q=0.707$ is specified.

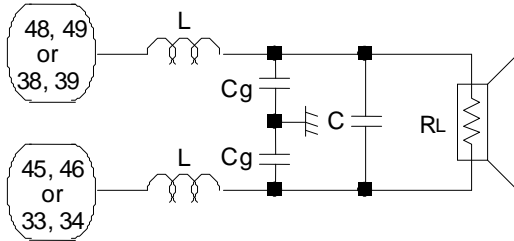

Fig. 12

$$L = \frac{R_L \sqrt{2}}{4 \pi f_c} \text{ (H)}$$

$$C = \frac{1}{2 \pi f_c R_L \sqrt{2}} \text{ (F)}$$

$$C_g = 0.2 C \text{ (F)}$$

R_L : Load impedance (Ω)
 f_c : LPF cut off frequency (Hz)

Following presents output LC filter constants with typical load impedances.

$f_c = 30\text{kHz}$				$f_c = 40\text{kHz}$			
R_L	L	C	C_g	R_L	L	C	C_g
6 Ω	22 μH	0.68 μF	0.15 μF	6 Ω	15 μH	0.47 μF	0.1 μF
8 Ω	33 μH	0.47 μF	0.1 μF	8 Ω	22 μH	0.33 μF	0.068 μF
16 Ω	68 μH	0.22 μF	0.047 μF	16 Ω	47 μH	0.15 μF	0.033 μF

Use coils with a low direct-current resistance and with a sufficient margin of allowable currents. A high direct-current resistance causes power losses. In addition, select a closed magnetic circuit type product in normal cases to prevent unwanted emission.

Use capacitors with a low equivalent series resistance, and good impedance characteristics at high frequency ranges (100kHz or higher). Also, select an item with sufficient withstand voltage because flowing massive amount of high-frequency currents is expected.

●Notes for use

- 1) Absolute maximum ratings
Use of the IC in excess of absolute maximum ratings such as the applied voltage or operating temperature range may result in IC damage. Assumptions should not be made regarding the state of the IC (short mode or open mode) when such damage is suffered. A physical safety measure such as a fuse should be implemented when use of the IC in a special mode where the absolute maximum ratings may be exceeded is anticipated.
- 2) Power supply lines
As return of current regenerated by back EMF of output coil happens, take steps such as putting capacitor between power supply and GND as a electric pathway for the regenerated current. Be sure that there is no problem with each property such as emptied capacity at lower temperature regarding electrolytic capacitor to decide capacity value. If the connected power supply does not have sufficient current absorption capacity, regenerative current will cause the voltage on the power supply line to rise, which combined with the product and its peripheral circuitry may exceed the absolute maximum ratings. It is recommended to implement a physical safety measure such as the insertion of a voltage clamp diode between the power supply and GND pins.
- 3) GND potential (Pin 4, 36, 37, 45, 46), VSS potential (Pin 15, 20)
Any state must become the lowest voltage about GND terminal and VSS terminal.
- 4) Input terminal
The parasitic elements are formed in the IC because of the voltage relation. The parasitic element operating causes the wrong operation and destruction. Therefore, please be careful so as not to operate the parasitic elements by impressing to input terminals lower voltage than GND and VSS. Please do not apply the voltage to the input terminal when the power-supply voltage is not impressed.
- 5) Setting of heat
Use a thermal design that allows for a sufficient margin in light of the power dissipation (Pd) in actual operating conditions. This IC exposes its frame of the backside of package. Note that this part is assumed to use after providing heat dissipation treatment to improve heat dissipation efficiency. Try to occupy as wide as possible with heat dissipation pattern not only on the board surface but also the backside.
Class D speaker amplifier is high efficiency and low heat generation by comparison with conventional Analog power amplifier. However, In case it is operated continuously by maximum output power, Power dissipation (Pdiss) may exceed package dissipation. Please consider about heat design that Power dissipation (Pdiss) does not exceed Package dissipation (Pd) in average power (Poav). (Tjmax : Maximum junction temperature=150 °C, Ta : Peripheral temperature[°C], θja : Thermal resistance of package[°C/W], Poav : Average power[W], η : Efficiency)
Package dissipation : $Pd(W)=(Tjmax - Ta) / \theta ja$
Power dissipation : $Pdiss(W)= Poav \times (1 / \eta - 1)$
- 6) Actions in strong magnetic field
Use caution when using the IC in the presence of a strong magnetic field as doing so may cause the IC to malfunction.
- 7) Thermal shutdown circuit
This product is provided with a built-in thermal shutdown circuit. When the thermal shutdown circuit operates, the output transistors are placed under open status. The thermal shutdown circuit is primarily intended to shut down the IC avoiding thermal runaway under abnormal conditions with a chip temperature exceeding Tjmax = 150°C.
- 8) Shorts between pins and misinstallation
When mounting the IC on a board, pay adequate attention to orientation and placement discrepancies of the IC. If it is misinstalled and the power is turned on, the IC may be damaged. It also may be damaged if it is shorted by a foreign substance coming between pins of the IC or between a pin and a power supply or a pin and a GND.
- 9) Power supply on/off (Pin 27, 30, 31, 51, 52)
In case power supply is started up, RESETX(Pin 10), MUTEX(Pin 11) and PDX (Pin 12) always should be set Low. And in case power supply is shut down, it should be set Low likewise. Then it is possible to eliminate pop noise when power supply is turned on/off. And also, all power supply terminals should start up and shut down together.
- 10) ERROR terminal(Pin 26)
A error flag is outputted when Output short protection and DC voltage protection in the speaker are operated. These flags are the function which the condition of this product is shown in.
- 11) N.C. terminal (Pin 29, 32, 41, 50, 53)
N.C. terminal (Non Connection Pin) does not connect to the inside circuit. Therefore, possible to use open.
- 12) TEST terminal (Pin 17, 21)
TEST terminal connects with ground to prevent the malfunction by external noise.
- 13) Precautions for Spealer-setting
If the impedance characteristics of the speakers at high-frequency range while increase rapidly, the IC might not have stable-operation in the resonance frequency range of the LC-filter. Therefore, consider adding damping-circuit, etc., depending on the impedance of the speaker.

● Allowable Power Dissipation

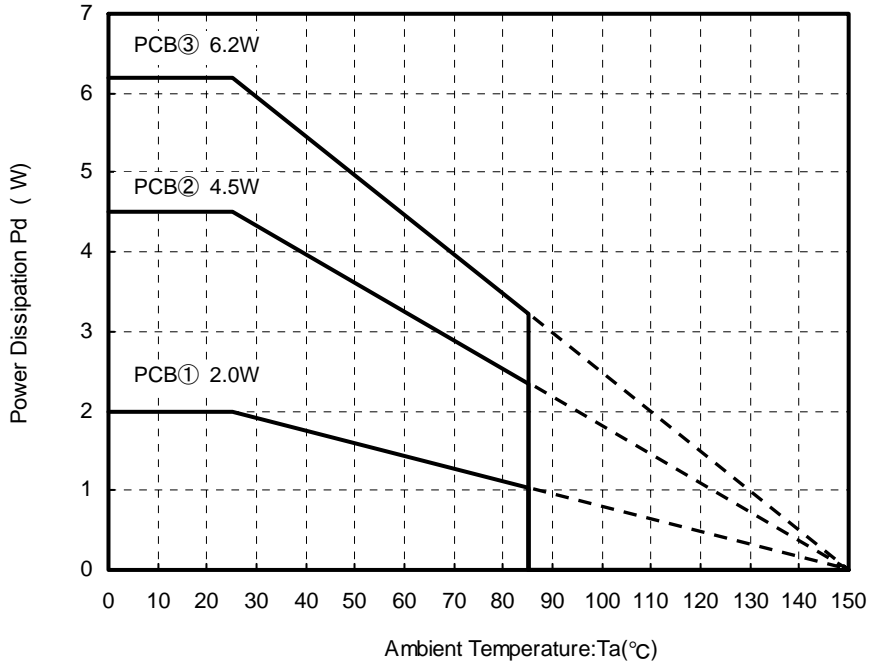

Measuring instrument: TH-156(Shibukawa Kuwano Electrical Instruments Co., Ltd.)

Measuring conditions: Installation on ROHM's board

Board size: 70mm×70mm×1.6mm(with thermal via on board)

Material: FR4

• The board on exposed heat sink on the back of package are connected by soldering.

PCB① : 1-layer board(back copper foil size: 0mm×0mm), $\theta_{ja}=62.5^{\circ}\text{C/W}$

PCB② : 2-layer board(back copper foil size: 70mm×70mm), $\theta_{ja}=27.8^{\circ}\text{C/W}$

PCB③ : 4-layer board(back copper foil size: 70mm×70mm), $\theta_{ja}=20.2^{\circ}\text{C/W}$

● Ordering part number

B	M
---	---

Part No.

5	4	4	6
---	---	---	---

Part No.

E	F	V
---	---	---

Package
EFV : HTSSOP-B54

E	2
---	---

Packaging and forming specification
E2: Embossed tape and reel

HTSSOP-B54

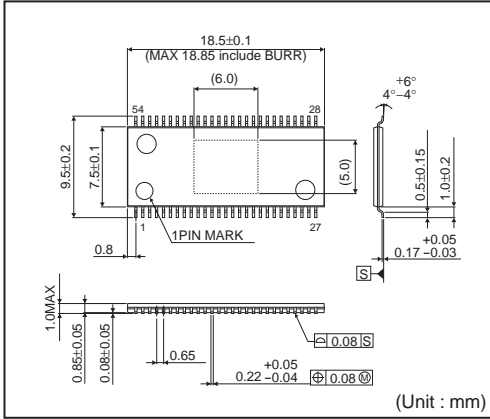

<Tape and Reel information>

Tape	Embossed carrier tape (with dry pack)
Quantity	1500pcs
Direction of feed	E2 (The direction is the 1pin of product is at the upper left when you hold reel on the left hand and you pull out the tape on the right hand)

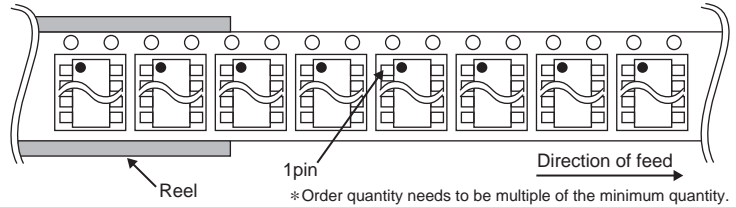

Notice

Precaution on using ROHM Products

- Our Products are designed and manufactured for application in ordinary electronic equipments (such as AV equipment, OA equipment, telecommunication equipment, home electronic appliances, amusement equipment, etc.). If you intend to use our Products in devices requiring extremely high reliability (such as medical equipment ^(Note 1), transport equipment, traffic equipment, aircraft/spacecraft, nuclear power controllers, fuel controllers, car equipment including car accessories, safety devices, etc.) and whose malfunction or failure may cause loss of human life, bodily injury or serious damage to property ("Specific Applications"), please consult with the ROHM sales representative in advance. Unless otherwise agreed in writing by ROHM in advance, ROHM shall not be in any way responsible or liable for any damages, expenses or losses incurred by you or third parties arising from the use of any ROHM's Products for Specific Applications.

(Note1) Medical Equipment Classification of the Specific Applications

JAPAN	USA	EU	CHINA
CLASS III	CLASS III	CLASS II b	CLASS III
CLASS IV		CLASS III	

- ROHM designs and manufactures its Products subject to strict quality control system. However, semiconductor products can fail or malfunction at a certain rate. Please be sure to implement, at your own responsibilities, adequate safety measures including but not limited to fail-safe design against the physical injury, damage to any property, which a failure or malfunction of our Products may cause. The following are examples of safety measures:
 - Installation of protection circuits or other protective devices to improve system safety
 - Installation of redundant circuits to reduce the impact of single or multiple circuit failure
- Our Products are designed and manufactured for use under standard conditions and not under any special or extraordinary environments or conditions, as exemplified below. Accordingly, ROHM shall not be in any way responsible or liable for any damages, expenses or losses arising from the use of any ROHM's Products under any special or extraordinary environments or conditions. If you intend to use our Products under any special or extraordinary environments or conditions (as exemplified below), your independent verification and confirmation of product performance, reliability, etc. prior to use, must be necessary:
 - Use of our Products in any types of liquid, including water, oils, chemicals, and organic solvents
 - Use of our Products outdoors or in places where the Products are exposed to direct sunlight or dust
 - Use of our Products in places where the Products are exposed to sea wind or corrosive gases, including Cl₂, H₂S, NH₃, SO₂, and NO₂
 - Use of our Products in places where the Products are exposed to static electricity or electromagnetic waves
 - Use of our Products in proximity to heat-producing components, plastic cords, or other flammable items
 - Sealing or coating our Products with resin or other coating materials
 - Use of our Products without cleaning residue of flux (even if you use no-clean type fluxes, cleaning residue of flux is recommended); or Washing our Products by using water or water-soluble cleaning agents for cleaning residue after soldering
 - Use of the Products in places subject to dew condensation
- The Products are not subject to radiation-proof design.
- Please verify and confirm characteristics of the final or mounted products in using the Products.
- In particular, if a transient load (a large amount of load applied in a short period of time, such as pulse. is applied, confirmation of performance characteristics after on-board mounting is strongly recommended. Avoid applying power exceeding normal rated power; exceeding the power rating under steady-state loading condition may negatively affect product performance and reliability.
- De-rate Power Dissipation (Pd) depending on Ambient temperature (Ta). When used in sealed area, confirm the actual ambient temperature.
- Confirm that operation temperature is within the specified range described in the product specification.
- ROHM shall not be in any way responsible or liable for failure induced under deviant condition from what is defined in this document.

Precaution for Mounting / Circuit board design

- When a highly active halogenous (chlorine, bromine, etc.) flux is used, the residue of flux may negatively affect product performance and reliability.
- In principle, the reflow soldering method must be used; if flow soldering method is preferred, please consult with the ROHM representative in advance.

For details, please refer to ROHM Mounting specification

Precautions Regarding Application Examples and External Circuits

1. If change is made to the constant of an external circuit, please allow a sufficient margin considering variations of the characteristics of the Products and external components, including transient characteristics, as well as static characteristics.
2. You agree that application notes, reference designs, and associated data and information contained in this document are presented only as guidance for Products use. Therefore, in case you use such information, you are solely responsible for it and you must exercise your own independent verification and judgment in the use of such information contained in this document. ROHM shall not be in any way responsible or liable for any damages, expenses or losses incurred by you or third parties arising from the use of such information.

Precaution for Electrostatic

This Product is electrostatic sensitive product, which may be damaged due to electrostatic discharge. Please take proper caution in your manufacturing process and storage so that voltage exceeding the Products maximum rating will not be applied to Products. Please take special care under dry condition (e.g. Grounding of human body / equipment / solder iron, isolation from charged objects, setting of Ionizer, friction prevention and temperature / humidity control).

Precaution for Storage / Transportation

1. Product performance and soldered connections may deteriorate if the Products are stored in the places where:
 - [a] the Products are exposed to sea winds or corrosive gases, including Cl₂, H₂S, NH₃, SO₂, and NO₂
 - [b] the temperature or humidity exceeds those recommended by ROHM
 - [c] the Products are exposed to direct sunshine or condensation
 - [d] the Products are exposed to high Electrostatic
2. Even under ROHM recommended storage condition, solderability of products out of recommended storage time period may be degraded. It is strongly recommended to confirm solderability before using Products of which storage time is exceeding the recommended storage time period.
3. Store / transport cartons in the correct direction, which is indicated on a carton with a symbol. Otherwise bent leads may occur due to excessive stress applied when dropping of a carton.
4. Use Products within the specified time after opening a humidity barrier bag. Baking is required before using Products of which storage time is exceeding the recommended storage time period.

Precaution for Product Label

QR code printed on ROHM Products label is for ROHM's internal use only.

Precaution for Disposition

When disposing Products please dispose them properly using an authorized industry waste company.

Precaution for Foreign Exchange and Foreign Trade act

Since our Products might fall under controlled goods prescribed by the applicable foreign exchange and foreign trade act, please consult with ROHM representative in case of export.

Precaution Regarding Intellectual Property Rights

1. All information and data including but not limited to application example contained in this document is for reference only. ROHM does not warrant that foregoing information or data will not infringe any intellectual property rights or any other rights of any third party regarding such information or data. ROHM shall not be in any way responsible or liable for infringement of any intellectual property rights or other damages arising from use of such information or data.:
2. No license, expressly or implied, is granted hereby under any intellectual property rights or other rights of ROHM or any third parties with respect to the information contained in this document.

Other Precaution

1. This document may not be reprinted or reproduced, in whole or in part, without prior written consent of ROHM.
2. The Products may not be disassembled, converted, modified, reproduced or otherwise changed without prior written consent of ROHM.
3. In no event shall you use in any way whatsoever the Products and the related technical information contained in the Products or this document for any military purposes, including but not limited to, the development of mass-destruction weapons.
4. The proper names of companies or products described in this document are trademarks or registered trademarks of ROHM, its affiliated companies or third parties.

General Precaution

1. Before you use our Products, you are requested to carefully read this document and fully understand its contents. ROHM shall not be in any way responsible or liable for failure, malfunction or accident arising from the use of any ROHM's Products against warning, caution or note contained in this document.
2. All information contained in this document is current as of the issuing date and subject to change without any prior notice. Before purchasing or using ROHM's Products, please confirm the latest information with a ROHM sales representative.
3. The information contained in this document is provided on an "as is" basis and ROHM does not warrant that all information contained in this document is accurate and/or error-free. ROHM shall not be in any way responsible or liable for any damages, expenses or losses incurred by you or third parties resulting from inaccuracy or errors of or concerning such information.

Mouser Electronics

Authorized Distributor

Click to View Pricing, Inventory, Delivery & Lifecycle Information:

[ROHM Semiconductor:](#)

[BM5446EFV-E2](#)



Стандарт Электрон Связь

Мы молодая и активно развивающаяся компания в области поставок электронных компонентов. Мы поставляем электронные компоненты отечественного и импортного производства напрямую от производителей и с крупнейших складов мира.

Благодаря сотрудничеству с мировыми поставщиками мы осуществляем комплексные и плановые поставки широчайшего спектра электронных компонентов.

Собственная эффективная логистика и склад в обеспечивает надежную поставку продукции в точно указанные сроки по всей России.

Мы осуществляем техническую поддержку нашим клиентам и предпродажную проверку качества продукции. На все поставляемые продукты мы предоставляем гарантию .

Осуществляем поставки продукции под контролем ВП МО РФ на предприятия военно-промышленного комплекса России , а также работаем в рамках 275 ФЗ с открытием отдельных счетов в уполномоченном банке. Система менеджмента качества компании соответствует требованиям ГОСТ ISO 9001.

Минимальные сроки поставки, гибкие цены, неограниченный ассортимент и индивидуальный подход к клиентам являются основой для выстраивания долгосрочного и эффективного сотрудничества с предприятиями радиоэлектронной промышленности, предприятиями ВПК и научно-исследовательскими институтами России.

С нами вы становитесь еще успешнее!

Наши контакты:

Телефон: +7 812 627 14 35

Электронная почта: sales@st-electron.ru

Адрес: 198099, Санкт-Петербург,
Промышленная ул, дом № 19, литера Н,
помещение 100-Н Офис 331