

177-619

April 1983

XB2-B

control and
signalling units $\varnothing 22$

175 451 to 475
~~175~~-501 \rightarrow 509

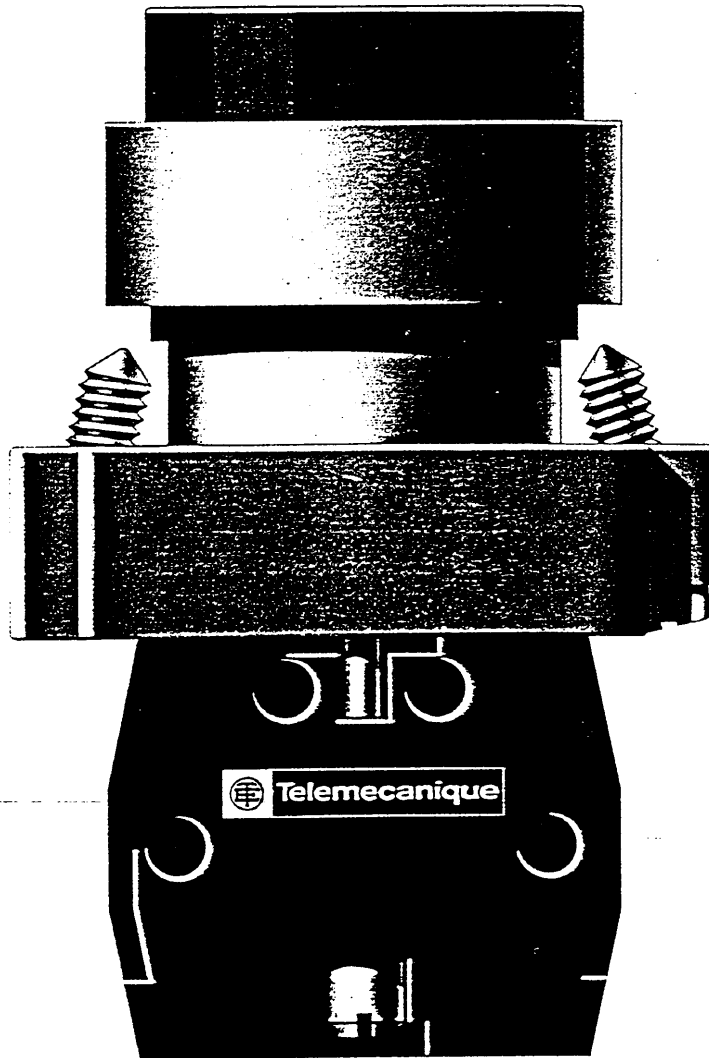

Contents

General characteristics

General	2
Environment, contact block characteristics	3

Control units

Adaptable sub-assemblies	Operating heads for pushbuttons	4
	Operating heads for selector switches	5
	Double-headed pushbutton operators	6
	Double-headed pushbutton operators with pilot light	7
	Body/contact assemblies	8
	Supplementary contact blocks	8
Complete units	Mechanical overload resets	9

Signalling units

Adaptable sub-assemblies	Bodies and lenses for pilot lights	10
	Body/contact assemblies	11
	Operating heads for pilot lights	12
	Operating heads for illuminated selector switches	12
	Operating heads for "push to test" pilot lights	12

Accessories and spare parts

Bulbs, blanking plugs, tools	13
------------------------------	----

Legends

Legend plates for mounting between operating head and panel	13
ISO legends for mounting within operating heads	14, 15

Small joystick controllers

Complete units	2 and 4 position controllers	16
	Legends	16

Dimensions

Control and signalling units	17
Double-headed pushbutton operators	18
Small joystick controllers	19

Telemecanique in Great Britain



*Our company's policy is one of continuous development and improvement and we reserve the right to supply products which may differ from those illustrated in this brochure.
All our products are sold subject to our Standard Conditions of Sale, available on request.*

General characteristics of control and signalling units XB2-B Ø22.2(fixing)

General

This range of Ø22.2 pushbuttons, selector switches, pilot lights, illuminated pushbuttons, illuminated selector switches and small joystick controllers is designed to meet the requirements of an international market.

Aesthetic

Shape and colours.
Metal bezel, nickel plated and chromed.
Alternatively, metal bezel, matt black anodised.

Ergonomic design

Circular operating surface area greater than that of a Ø30.5mm control unit.

Robust

All the parts whose mechanical function is of prime importance are made of zinc alloy. Insulating parts are made of polyamide reinforced with glass fibre.

Safe

-Fixing method unaffected by excessive vibration, unit will not rotate.
-Positive contact opening.
-Very good flame resistance (class VO in accordance to UL94).
-Protection against electrical shock (unit earthed).

Speed and simplicity of fixing

A screwdriver is all that is required.

Operating heads

The operating heads are functionally interchangeable on the different types of body/contact assemblies.

Body/contact assemblies

For pushbuttons and selector switches:
1-6 contact blocks (N/O or N/C), except for push-pull mushroom heads which are 4 maximum.

For pilot lights, illuminated pushbuttons and illuminated selector switches:
Bodies for direct supply, direct supply through resistor or via integral transformer.

Supply voltage: 6-600V, according to body type.

Bulb: incandescent with type BA9s base.

1 or 2 contacts (N/O or N/C) for illuminated pushbuttons and illuminated selector switches.

The same contact blocks are used throughout the range.

They are slow break and self wiping. Contact tips are made of nickel-silver and the moving bridge of copper. Contact blocks are interchangeable and may be stacked on without additional mounting components. They are protected against the penetration of small objects during assembly and wiring.

Gold flashed contacts are also available.

Fixing

XB2-B manual pilot devices can be fixed in any position on panels of thickness 1 to 6mm.

The operating heads lock on to the base unit using a 1/8th turn bayonet fixing which makes for a simple and fast assembly.

Finally, the complete assembly is locked in to position on the mounting plate by two pointed screws Ø4mm, tightened from the rear. These screws also ensure the earthing of the unit.

Small joystick controllers

- Type XD2-P (compact, contacts non interchangeable).
Fixing centres 30 x 85mm (2 position) or 85 x 85mm (4 position).
2 or 4 position, with or without spring return to the zero position.
1 N/O contact per position.

- Type XD2-G
Fixing centres 90 x 90mm (2 and 4 position).
2 or 4 position, with or without spring return.
1 N/O contact per position.
Additional features:
-variable composition to 2, 3 or 4 position.
-controlling 1, 2 or 4 contacts in each position.
-1 or 2 notches per position, stay-put or spring return.
Details on request.

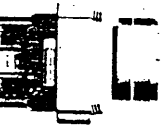





Environment

Conformity to standards	IEC 337-1, IEC 337-2, NFC 63-140, ASE 0119, ASE 1003, BS 4794, VDE 0660 part 2, UL 506, UL 508, CSA C22-2 No. 14, CSA C22-2 No. 66.
Approvals	Demko, Semko, Nemko, Elektriska Inspektoratet, GL Standard version: CSA 300V (AC) heavy duty, (DC) standard duty; Bureau Veritas; ASE; UL (listed) 300V (AC) heavy duty, (DC) standard duty.
Protective treatment	Standard version: "All climates."
Ambient temperature	Operating: -25 to +70°C. Storage: -40 to +70°C.
Altitude	<3000m
Operating position	All positions.
Resistance to vibration	Ø60mm mushroom head: 8g. Other pushbuttons: 15g. Small joystick controllers: 5g. (from 40 to 500Hz) in accordance with IEC 68-2-6.
Resistance to shock	Pushbuttons: 70g. Mushroom head pushbuttons: 15g. Double headed pushbuttons: 50g. Selector switches: 200g. In accordance with IEC 68-2-6.
Protection against electrical shock	Class 1, in accordance with IEC 536 and NF C20-030.
Degree of protection in accordance with IEC 529 and NF C20-010	IP40: basic double-headed pushbutton. IP65: flush and projecting, illuminated and non-illuminated pushbuttons (mounted). IP66: booted and mushroom head pushbuttons, selector switches, pilot lights, and small joystick controllers (mounted).
Mechanical life	Spring return pushbuttons, selector switches and small joystick controllers: 1 million operations. Latching mushroom head pushbuttons: 300,000 operations.

Contact block characteristics

Nominal thermal current	10A in accordance with IEC 337-1, NF C63-140, UL 508, CSA C22-2 No. 14, VDE 0660.
Nominal insulation voltage	500V in accordance with IEC 158-1, NF C20-040, VDE 0110. 300V in accordance with UL 508, CSA C22-2 No. 14.
Insulation category	Group C in accordance with NF C20-040 and VDE 0110.
Contact operation	Slow break N/O or N/C.
Contact resistance (between terminals)	<25mΩ: Standard <14mΩ: Gold flashed
Operating force	Flush and projecting pushbuttons -with 1N/O contact: 10N -with 1N/C contact: 8N. Additional contacts -N/O: +5N -N/C: +3N.
Terminal referencing	According to CENELEC EN 50013. Numbers indicating the function are marked on the contact block, either: 1-2 for a N/C contact or 3-4 for a N/O contact The contact order number is marked on the diecast base, i.e.: First row of contacts: 1 for left hand contact block, 2 for right hand contact block. Second row of contacts: 3 for left hand contact block, 4 for right hand contact block.
Short circuit protection	10A cartridge fuses, g1 or N in accordance with IEC 337-1B.

Making and breaking capacities in accordance with IEC 337-1 and VDE 0660 part 2	Voltage V	AC ~ 50-60Hz Power broken in kVA For 50 operations						DC --- Power broken in W For 20 operations						
		12	24	48	127	220	380	500	12	24	48	110	220	440
Pushbuttons XB2-B and Small joystick controllers XD2-GA		0.8	1.5	4.4	9.6	15.6	24	32	1000	600	870	240	190	130
Small joystick controllers XD2-PA		0.8	1.5	4	9	15	21	24	650	390	260	165	115	85

Rated power in accordance with IEC 337-1 Duty categories AC11 and DC11	Voltage V	AC ~ 50-60Hz Power broken in VA						DC --- Power broken in W							
		12	24	48	127	220	380	500	12	24	48	110	220	440	
For 1 million operations Operating frequency: 3600 ops./hour Load factor: 0.5	Pushbuttons XB2-B and Small joystick controllers XD2-GA		100	200	400	650	700	600	500	95	65	48	40	30	25
	Small joystick controllers XD2-PA		120	240	480	1000	1200	1500	1500	120	240	300	170	110	70
			100	200	400	550	600	500	400	58	40	30	23	20	15
			120	240	475	850	1100	1200	1200	120	240	135	110	70	45

Cabling Screw and captive cable clamp terminals. Capacity: minimum 1 x 0.5mm², maximum, with or without cable end, 2 x 1.5mm² or 1 x 2.5mm². Versions are also available for cable clip connections (to NF C20-120).

circular head, chromium plated metal bezel

Bodies : see page 8
 Legends : see pages 13 to 15
 Dimensions: see page 17

Operating heads for pushbuttons

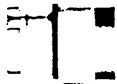

ZB2-BA•



ZB2-BL•

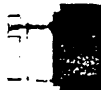

ZB2-BP•

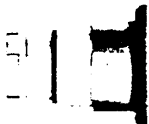

ZB2-BC•

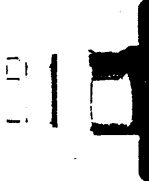

ZB2-BX•



ZB2-BS54



ZB2-BS24

Description	Colour	Reference	For ISO legends	Weight kg
Flush	White	ZB2-BA1	-	0.030
	Black	ZB2-BA2	-	0.030
	Green	ZB2-BA3	ZB2-BA38	0.030
	Red	ZB2-BA4	ZB2-BA48	0.030
	Yellow	ZB2-BA5	ZB2-BA58	0.030
	Blue	ZB2-BA6	ZB2-BA68	0.030
	Clear	ZB2-BA7	ZB2-BA78	0.030
Projecting	White	ZB2-BL1	-	0.030
	Black	ZB2-BL2	-	0.030
	Green	ZB2-BL3	ZB2-BW13	0.030
	Red	ZB2-BL4	ZB2-BW14	0.030
	Yellow	ZB2-BL5	ZB2-BW15	0.030
	Blue	ZB2-BL6	ZB2-BW16	0.030
	Clear	-	ZB2-BW17	0.030
Projecting Push and push to release	Black	ZB2-BH2	-	0.032
	Green	-	ZB2-BH3	0.032
	Red	-	ZB2-BH4	0.032
	Yellow	-	ZB2-BH5	0.032
	Blue	-	ZB2-BH6	0.032
	Clear	-	ZB2-BH7	0.032
	Black	ZB2-BP2	-	0.030
Booted	Green	ZB2-BP3	ZB2-BP38	0.030
	Red	ZB2-BP4	ZB2-BP48	0.030
	Yellow	ZB2-BP5	ZB2-BP58	0.030
	Blue	ZB2-BP6	ZB2-BP68	0.030
	Clear	-	ZB2-BP78	0.030

Mushroom operating heads

Spring return	Ø40mm	Black	ZB2-BC2	0.045
		Green	ZB2-BC3	0.045
		Red	ZB2-BC4	0.045
		Yellow	ZB2-BC5	0.045
		Blue	ZB2-BC6	0.045
			Ø60mm	Black
Green	ZB2-BR3			0.055
Red	ZB2-BR4			0.055
Yellow	ZB2-BR5			0.055
Push-pull stay put	Ø40mm			Black
		Red	ZB2-BT4	0.075
	Ø60mm	Black	ZB2-BX2	0.080
		Red	ZB2-BX4	0.080
Latching turn to release	Ø30mm	Red	ZB2-BS44	0.045
	Ø40mm	Black	ZB2-BS52	0.055
		Red	ZB2-BS54	0.055
		Yellow	ZB2-BS55	0.055
	Ø60mm	Red	ZB2-BS64	0.065
	Latching key release (Ronis key No. 455)	Ø30mm	Red	ZB2-BS74
Ø40mm		Red	ZB2-BS14	0.090
Ø60mm		Red	ZB2-BS24	0.120

+ Other versions

For colours other than those mentioned above...
 For other key numbers...
 Details on request.

When ordering



an operating head.
 Please state the exact reference.
 Example: ZB2-BA2

circular head, chromium plated metal bezel

Bodies : see page 8
Legends : see page 13
Dimensions: see page 17

Operating heads for selector switches



ZB2-BD•

Description			Reference	Weight kg
Standard handle (1)	2 position	stay put	ZB2-BD2	0.040
		spring return from right to left	ZB2-BD4	0.040
	3 position	stay put	ZB2-BD3	0.040
		spring return to centre	ZB2-BD5	0.040
		stay put on left, spring return from right to centre	ZB2-BD8	0.040
		stay put on right, spring return from left to centre	ZB2-BD7	0.040
Long handle (1)	2 position	stay put	ZB2-BJ2	0.040
		spring return from right to left	ZB2-BJ4	0.040
	3 position	stay put	ZB2-BJ3	0.040
		spring return to centre	ZB2-BJ5	0.040
		stay put on left, spring return from right to centre	ZB2-BJ8	0.040
		stay put on right, spring return from left to centre	ZB2-BJ7	0.040



ZB2-BJ•

(1) Standard handle black

For white handle add 01 to reference. Example: ZB2-BD201

For red handle add 04 to reference. Example: ZB2-BD204

Operating heads for key switches (Ronis key No. 455)



ZB2-BG•

Description		Key withdrawal	Reference	Weight
2 position	stay put	left hand position	ZB2-BG2	0.070
		left and right hand positions	ZB2-BG4	0.070
	spring return from right to left	left hand position	ZB2-BG6	0.070
3 position	stay put	all positions	ZB2-BG0	0.070
		centre position	ZB2-BG3	0.070
		left and right hand positions	ZB2-BG5	0.070
		left hand position	ZB2-BG9	0.070
		right hand position	ZB2-BG09	0.070
	spring return to centre	centre position	ZB2-BG7	0.070
	stay put on right, spring return from left to centre	right hand position	ZB2-BG1	0.070

+ Other versions

Operating heads are available with mechanical functions other than those shown above.
Other key numbers. Details on request.

When ordering



an operating head.
Please state the exact reference.
Example: ZB2-BD2

Double-headed, rectangular pushbutton operators with chromium plated metal bezel

Bodies : see page 8
Dimensions: see page 18

Double-headed pushbutton operators IP40

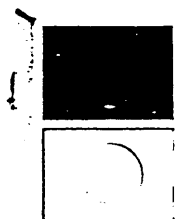

ZB2-BA8224

Description	Colour of operators	Marking	Reference	Weight kg
2 Flush	Black Red	Unmarked	ZB2-BA8124	0.048
		Marked "I" "O"	ZB2-BA8224	0.048
	Green Red	Unmarked	ZB2-BA8134	0.048
		Marked "I" "O"	ZB2-BA8234	0.048
1 Flush 1 Projecting	Black Red	Unmarked	ZB2-BL8324	0.048
		Marked "I" "O"	ZB2-BL8424	0.048
	Green Red	Unmarked	ZB2-BL8334	0.048
		Marked "I" "O"	ZB2-BL8434	0.048



ZB2-BL8334

Double-headed pushbutton operators IP65

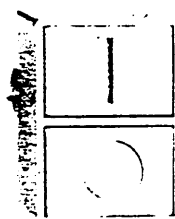

ZB2-BA9234

Description	Colour of operators	Marking	Reference	Weight kg
2 Flush	Black Red	Unmarked	ZB2-BA9124	0.048
		Marked "I" "O"	ZB2-BA9224	0.048
	Green Red	Unmarked	ZB2-BA9134	0.048
1 Flush 1 Projecting	Black Red	Marked "I" "O"	ZB2-BA9234	0.048
		Unmarked	ZB2-BL9324	0.048
	Green Red	Marked "I" "O"	ZB2-BL9424	0.048
		Unmarked	ZB2-BL9334	0.048
Marked "I" "O"		ZB2-BL9434	0.048	

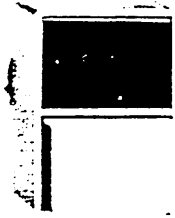

ZB2-BL9324

When ordering



a double-headed pushbutton operator.
Please state the exact reference.
Example: ZB2-BA8124

Double-headed, rectangular pushbutton operators with chromium plated metal bezel

Bodies : see page 11
Dimensions: see page 18



ZB2-BW81254

Operating heads for pushbuttons, with pilot light incorporating yellow lens

Description	Colour of operators	Marking	Reference	Weight kg
2 Flush 1 Pilot light IP40*	Black	Unmarked	ZB2-BW81254	0.043
	Red	Marked "I" "O"	ZB2-BW82254	0.043
	Green	Unmarked	ZB2-BW81354	0.043
	Red	Marked "I" "O"	ZB2-BW82354	0.043
1 Flush 1 Projecting 1 Pilot light IP40*	Black	Unmarked	ZB2-BW83254	0.043
	Red	Marked "I" "O"	ZB2-BW84254	0.043
	Green	Unmarked	ZB2-BW83354	0.043
	Red	Marked "I" "O"	ZB2-BW84354	0.043



ZB2-BW84204

Operating heads for pushbuttons, with pilot light without lens

Description	Colour of operators	Marking	Reference	Weight kg
2 Flush 1 Pilot light IP40*	Black	Unmarked	ZB2-BW81204	0.042
	Red	Marked "I" "O"	ZB2-BW82204	0.042
	Green	Unmarked	ZB2-BW81304	0.042
	Red	Marked "I" "O"	ZB2-BW82304	0.042
1 Flush 1 Projecting 1 Pilot light IP40*	Black	Unmarked	ZB2-BW83204	0.042
	Red	Marked "I" "O"	ZB2-BW84204	0.042
	Green	Unmarked	ZB2-BW83304	0.042
	Red	Marked "I" "O"	ZB2-BW84304	0.042

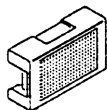

ZB2-BW90.

Lenses for pilot lights



Sold in lots of 10

Colour	Reference	Weight kg
Green	ZB2-BW903	0.001
Red	ZB2-BW904	0.001
Yellow	ZB2-BW905	0.001
Blue	ZB2-BW906	0.001
Clear	ZB2-BW907	0.001

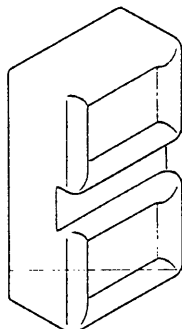

ZB2-BW008

Sealing boot

Silicone clear	ZB2-BW008	0.004
----------------	-----------	-------

*Increased to IP66 by addition of boot ZB2-BW008.

When ordering



a double-headed pushbutton operator.
Please state the exact reference. Example: ZB2-BW81354
a lens and/or a sealing boot.
Please state the exact reference. Example: ZB2-BW905





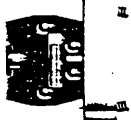

Body/contact assemblies
For use with operating heads shown on pages 4, 5 and 6

Dimensions: see page 17

Complete bodies; screw and captive cable clamp connections



ZB2-BZ10•

Description	Application	Scheme	Reference	Weight kg
With one contact block	Pushbuttons and 2 position selector switches	N/O 	ZB2-BZ101	0.040
		N/C 	ZB2-BZ102	0.040
With two contact blocks	2-way rectangular pushbuttons, pushbuttons and 2 or 3 position selector switches	N/O+N/O 	ZB2-BZ103	0.055
		N/C+N/C 	ZB2-BZ104	0.055
		N/O+N/C 	ZB2-BZ105	0.055
		N/O+N/C 	ZB2-BZ106	0.055
		N/O+N/O 	ZB2-BZ107	0.055
		2 step		

Supplementary contact blocks



ZB2-BE10•

Connections	Application	Type	Reference	Weight kg
Screw and captive cable clamp	For converting body/contact assemblies to 3, 4, 5 or 6 contacts maximum or replacing 1st or 2nd contact blocks	N/O Standard	ZB2-BE101	0.015
		Early make	ZB2-BE201	0.015
		N/C Standard	ZB2-BE102	0.015
	Late break	ZB2-BE202	0.015	
	For low power switching (<20V, <50mA) gold flashed contacts	N/O	ZB2-BE1016	0.015
		N/C	ZB2-BE1026	0.015

→ Other versions

Body/contact assemblies fitted with "faston" connectors (6.3) (conforming to NF C20-120).
Details on request

When ordering



a complete body/contact assembly.
Please state the exact reference. Example: ZB2-BZ101
a supplementary contact block.
Please state the exact reference. Example: ZB2-BE101

Mechanical overload resets Ø22.2 (fixing)

XB2-B

circular head, chromium plated metal bezel

Complete units

Legends: see page 13

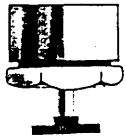

XB2-BA8●●

Description	Adjustable length	Colour	Reference	Weight kg
Flush pushbutton 10mm travel For mounting on plate 1 to 3mm thickness Fixing: secured by nut from rear	6 to 16mm	Black	XB2-BA821	0.030
		Red	XB2-BA841	0.030
		Blue	XB2-BA861	0.030
	16 to 26mm	Black	XB2-BA822	0.035
		Red	XB2-BA842	0.035
		Blue	XB2-BA862	0.035

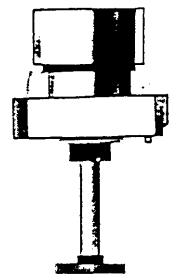

XB2-BA9●●
30 to 82mm

Flush pushbutton 14mm travel For mounting on plate 1 to 6mm thickness Fixing: secured by pointed screws from rear	30 to 57mm	Black	XB2-BA921	0.077
		Red	XB2-BA941	0.077
		Blue	XB2-BA961	0.077
	55 to 82mm	Black	XB2-BA922	0.080
		Red	XB2-BA942	0.080
		Blue	XB2-BA962	0.080
	80 to 107mm	Black	XB2-BA923	0.085
		Red	XB2-BA943	0.085
		Blue	XB2-BA963	0.085

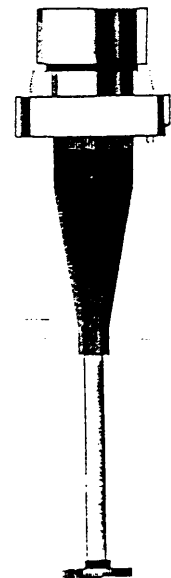

XB2-BA9●●
80 to 257mm

	105 to 132mm	Black	XB2-BA924	0.090
		Red	XB2-BA944	0.090
		Blue	XB2-BA964	0.090
	130 to 157mm	Black	XB2-BA925	0.095
		Red	XB2-BA945	0.095
		Blue	XB2-BA965	0.095
	155 to 182mm	Black	XB2-BA926	0.100
		Red	XB2-BA946	0.100
		Blue	XB2-BA966	0.100
180 to 207mm	Black	XB2-BA927	0.105	
	Red	XB2-BA947	0.105	
	Blue	XB2-BA967	0.105	
205 to 232mm	Black	XB2-BA928	0.110	
	Red	XB2-BA948	0.110	
	Blue	XB2-BA968	0.110	
230 to 257mm	Black	XB2-BA929	0.115	
	Red	XB2-BA949	0.115	
	Blue	XB2-BA969	0.115	

When ordering



a complete unit.
Please state the exact reference.
Example: XB2-BA822

Legends : see pages 13 to 15
Dimensions: see page 17

Heads (lens + bezel)



ZB2-BV0•



ZB2-BV0.3

	Colour	Reference	Weight kg
Standard lenses suitable for use with ISO legends	Green	ZB2-BV03	0.025
	Red	ZB2-BV04	0.025
	Yellow	ZB2-BV05	0.025
	Blue	ZB2-BV06	0.025
	Clear	ZB2-BV07	0.025
High contrast lenses	Green	ZB2-BV033	0.025
	Red	ZB2-BV043	0.025
	Yellow	ZB2-BV053	0.025
	Blue	ZB2-BV063	0.025
	Clear	ZB2-BV073	0.025

Complete body with screw and captive cable clamp connections



ZB2-BV6



ZB2-BV7

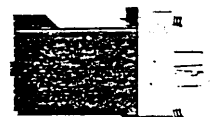

ZB2-BV••

Supply	Typical scheme	Maximum supply voltage	Reference	Weight kg
Direct bulb not supplied to order: see page 13		≤ 130V	ZB2-BV6	0.045
Direct through resistor bulb supplied type BA9s, 130V		220/240V	ZB2-BV7	0.055
Via integral transformer 1.2VA bulb supplied type BA9s, 6V		24V:50Hz	ZB2-BV1	0.110
		48V:50Hz	ZB2-BV2	0.110
		110V:50Hz	ZB2-BV3	0.110
		220/240V:50Hz	ZB2-BV4	0.110
		380V:50Hz	ZB2-BV5	0.110
		415V:50Hz	ZB2-BV93	0.110
		440/480:60Hz	ZB2-BV95	0.110
		500V:50Hz	ZB2-BV8	0.110
		500/600:60Hz	ZB2-BV98	0.110

Flashing pilot light body with screw and captive cable clamp connections

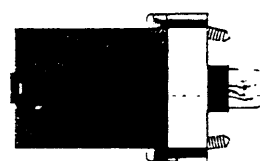

ZB2-BV1••

Description	Supply voltage	Reference	Weight kg
4 terminal output 3 states, off, flashing light and steady light	Bulb supplied type BA9s, 24V	24V:AC → ZB2-BV181	0.070
		24V:DC → ZB2-BV191	0.070
	Bulb supplied type BA9s, 48V	48V:AC → ZB2-BV183	0.070
		48V:DC → ZB2-BV193	0.070
	Bulb supplied type BA9s, 130V	110/127:AC → ZB2-BV184	0.070
		220/240:AC → ZB2-BV185	0.070

Schemes

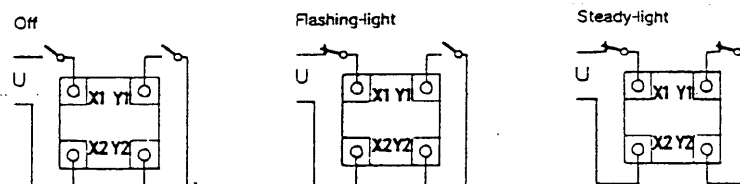

DC: U → - X1
+ X2

By the addition of up to 2 ZB2-BE10• contact blocks, these bodies may be used for flashing illuminated pushbutton and illuminated selector switch applications.

When ordering



a head, a complete body or a flashing pilot light body.
Please state the exact reference.
Examples: ZB2-BV03, ZB2-BV6, ZB2-BV181.

circular head, chromium plated metal bezel

Body/contact assemblies. For use with operator heads shown on pages 4 (ZB2-BH3 to 7 only), 7 and 12

Bulb information: see page 13
Dimensions : see page 17

Complete bodies; screw and captive cable clamp connections

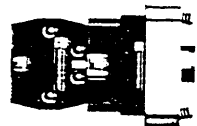

ZB2-BW06•

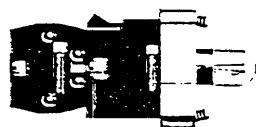

ZB2-BW07•



ZB2-BW0•••

Supply	Typical scheme	Maximum supply voltage	Contact arrangement	Reference	Weight kg
Direct		≤130V	N/O	ZB2-BW061	0.060
			N/C	ZB2-BW062	0.060
			N/O+N/O	ZB2-BW063	0.070
			N/C+N/C	ZB2-BW064	0.070
			N/O+N/C	ZB2-BW065	0.070
Direct through resistor bulb supplied type 8A9s, 130V		220/240	N/O	ZB2-BW071	0.065
			N/C	ZB2-BW072	0.065
			N/O+N/O	ZB2-BW073	0.080
			N/C+N/C	ZB2-BW074	0.080
			N/O+N/C	ZB2-BW075	0.080
Via integral transformer 1.2VA bulb supplied type 8A9s, 6V		24V:50Hz	N/O	ZB2-BW011	0.120
			N/C	ZB2-BW012	0.120
			N/O+N/O	ZB2-BW013	0.135
			N/C+N/C	ZB2-BW014	0.135
			N/O+N/C	ZB2-BW015	0.135
		48V:50Hz	N/O	ZB2-BW021	0.120
			N/C	ZB2-BW022	0.120
			N/O+N/O	ZB2-BW023	0.135
			N/C+N/C	ZB2-BW024	0.135
			N/O+N/C	ZB2-BW025	0.135
		110V:50Hz	N/O	ZB2-BW031	0.120
			N/C	ZB2-BW032	0.120
			N/O+N/O	ZB2-BW033	0.135
			N/C+N/C	ZB2-BW034	0.135
			N/O+N/C	ZB2-BW035	0.135
220/240V:50Hz		N/O	ZB2-BW041	0.120	
		N/C	ZB2-BW042	0.120	
		N/O+N/O	ZB2-BW043	0.135	
		N/C+N/C	ZB2-BW044	0.135	
		N/O+N/C	ZB2-BW045	0.135	
380V:50Hz		N/O	ZB2-BW051	0.120	
		N/C	ZB2-BW052	0.120	
		N/O+N/O	ZB2-BW053	0.135	
		N/C+N/C	ZB2-BW054	0.135	
		N/O+N/C	ZB2-BW055	0.135	
415V:50Hz		N/O	ZB2-BW0931	0.120	
		N/C	ZB2-BW0932	0.120	
		N/O+N/O	ZB2-BW0933	0.135	
		N/C+N/C	ZB2-BW0934	0.135	
		N/O+N/C	ZB2-BW0935	0.135	
440/480V:50Hz		N/O	ZB2-BW0951	0.120	
		N/C	ZB2-BW0952	0.120	
		N/O+N/O	ZB2-BW0953	0.135	
		N/C+N/C	ZB2-BW0954	0.135	
		N/O+N/C	ZB2-BW0955	0.135	
500V:50Hz		N/O	ZB2-BW081	0.120	
		N/C	ZB2-BW082	0.120	
		N/O+N/O	ZB2-BW083	0.135	
		N/C+N/C	ZB2-BW084	0.135	
		N/O+N/C	ZB2-BW085	0.135	
500/600V:60Hz		N/O	ZB2-BW0981	0.120	
		N/C	ZB2-BW0982	0.120	
		N/O+N/O	ZB2-BW0983	0.135	
		N/C+N/C	ZB2-BW0984	0.135	
		N/O+N/C	ZB2-BW0985	0.135	

Assemble units of your choice

by using our wide range of adaptable sub-assemblies.
• Bodies and lenses for pilot lights (see previous page).

When ordering



a complete body.
Please state the exact reference. Example: ZB2-BW061
Add the reference of the head, bulb and legend (if required).

circular head, chromium plated metal bezel

Operating heads (bezel + lens), suitable for use with ISO legends or separate legend plates



ZB2-BW3•



ZB2-BW1•

Type of operator	Colour	Reference	Weight kg	
Flush	Green	ZB2-BW33	0.025	
	Red	ZB2-BW34	0.025	
	Yellow	ZB2-BW35	0.025	
	Blue	ZB2-BW36	0.025	
	Clear	ZB2-BW37	0.025	
Projecting	Green	ZB2-BW13	0.030	
	Red	ZB2-BW14	0.030	
	Yellow	ZB2-BW15	0.030	
	Blue	ZB2-BW16	0.030	
	Clear	ZB2-BW17	0.030	
Flush booted	Green	ZB2-BW53	0.030	
	Red	ZB2-BW54	0.030	
Mushroom head Spring return	Ø40mm	Green	ZB2-BW43	0.030
	Red	ZB2-BW44	0.030	
Mushroom head Push-pull stay put	Ø40mm	Green	ZB2-BW63	0.030
	Red	ZB2-BW64	0.030	

Operating heads for illuminated selector switches



ZB2-BK•••

Description	Colour	Reference	Weight kg	
Standard handle 2 position	stay put	Green	ZB2-BK123	0.035
	Red	ZB2-BK124	0.035	
	Yellow	ZB2-BK125	0.035	
	Blue	ZB2-BK126	0.035	
	Clear	ZB2-BK127	0.035	
spring return right to left	Green	ZB2-BK143	0.035	
	Red	ZB2-BK144	0.035	
	Yellow	ZB2-BK145	0.035	
	Blue	ZB2-BK146	0.035	
	Clear	ZB2-BK147	0.035	
Standard handle 3 position	stay put	Green	ZB2-BK133	0.035
	Red	ZB2-BK134	0.035	
	Yellow	ZB2-BK135	0.035	
	Blue	ZB2-BK136	0.035	
	Clear	ZB2-BK137	0.035	
spring return to centre	Green	ZB2-BK153	0.035	
	Red	ZB2-BK154	0.035	
	Yellow	ZB2-BK155	0.035	
	Blue	ZB2-BK156	0.035	
	Clear	ZB2-BK157	0.035	
stay put on left, spring return from right to centre	Green	ZB2-BK183	0.035	
	Red	ZB2-BK184	0.035	
	Yellow	ZB2-BK185	0.035	
	Blue	ZB2-BK186	0.035	
	Clear	ZB2-BK187	0.035	
stay put on right, spring return from left to centre	Green	ZB2-BK173	0.035	
	Red	ZB2-BK174	0.035	
	Yellow	ZB2-BK175	0.035	
	Blue	ZB2-BK176	0.035	
	Clear	ZB2-BK177	0.035	

Operating heads for "push to test" pilot lights



ZB2-BV0•••

Green	ZB2-BV031	0.030
Red	ZB2-BV041	0.030
Yellow	ZB2-BV051	0.030
Blue	ZB2-BV061	0.030
Clear	ZB2-BV071	0.030

When ordering



an operating head.

Please state the exact reference. Example: ZB2-BW63.

Add the reference of the body, bulb and the legend (if required), see pages 11 and 13.

for XB2-B control and signalling units

Legend plates 30 x 40mm: Not suitable for use with double-headed pushbuttons

"Start" functions: white characters on black. "Stop" functions: white characters on red.

Text	Reference	Weight kg	Text	Reference	Weight kg
Without text					
Red or black background	ZB2-BY2101	0.001	White or yellow background	ZB2-BY4101	0.001
Standard texts					
For pushbuttons					
Start	ZB2-BY2303	0.001	Stop	ZB2-BY2304	0.001
Forward	ZB2-BY2305	0.001	Reverse	ZB2-BY2306	0.001
Up	ZB2-BY2307	0.001	Down	ZB2-BY2308	0.001
Right	ZB2-BY2309	0.001	Left	ZB2-BY2310	0.001
On	ZB2-BY2311	0.001	Off	ZB2-BY2312	0.001
Open	ZB2-BY2313	0.001	Close	ZB2-BY2314	0.001
Auto	ZB2-BY2115	0.001	Hand	ZB2-BY2116	0.001
Reset	ZB2-BY2323	0.001	Emergency stop	ZB2-BY2330	0.001
Power	ZB2-BY2326	0.001	Inch	ZB2-BY2321	0.001
Slow	ZB2-BY2337	0.001	Fast	ZB2-BY2328	0.001
For selector switches					
Auto-Hand	ZB2-BY2364	0.001	Auto-O-Hand	ZB2-BY2385	0.001

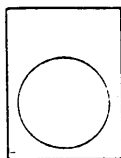

ZB2-BY...

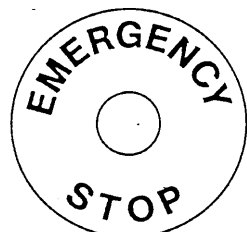

ZB2-BY...330



DL1-C...

Universal symbols

For pushbuttons			For selector switches		
O	ZB2-BY2146	0.001	O-H	ZB2-BY2178	0.001
I	ZB2-BY2147	0.001	I-H	ZB2-BY2179	0.001
II	ZB2-BY2148	0.001	I-O-II	ZB2-BY2186	0.001
III	ZB2-BY2149	0.001			

Special texts. Please state the exact wording required when ordering (2 lines max. 11 charas./line).

Black with white charas.	ZB2-BY2002	0.001	Yellow with black charas.	ZB2-BY4005	0.001
Red with white charas.	ZB2-BY2004	0.001	For a number of legends with the same text, please consult your regional sales office.		
White with black charas.	ZB2-BY4001	0.001			

Large legend plates for use with mushroom heads

Round, Ø60mm. Text: - "Emergency stop", yellow with black charas.	ZB2-BY9330	0.006
Round, Ø90mm. Text: - "Emergency stop", yellow with black charas.	ZB2-BY8330	0.008
Rectangular, 45 x 67.5. Without text, red background.	ZB2-BY5101	0.006

Bulbs

For use in direct supply units: BA9s base fitting. Incandescent bulbs; V ≤ 130V, maximum power 2.6W. Ø11mm maximum, length 28mm maximum.



Sold in lots of 10.

Incandescent bulbs

Voltage	Power	Unit Reference	Weight kg
6V	1.5W	DL1-CB006	0.002
12V	2.6W	DL1-CE012	0.002
24V	2.6W	DL1-CE024	0.002
48V	2.6W	DL1-CE048	0.002
130V	2.6W	DL1-CE130	0.002



ZB2-SZ3

Blanking plug for Ø22.2mm hole (sold singly)

Black insulating material	ZB2-SZ3	0.005
Grey insulating material	ZB2-SZ4	0.005

TOOLS (sold singly)

Bulb extractor for use with types BA9s	XBF-X13	0.025
Lens tool for ISO legend operators	ZB2-BZ8	0.006
Padlockable guard for flush pushbutton operators	ZB2-BZ6	0.090

Other versions

Legend plates with texts in other languages.
Please consult your regional sales office.

When ordering



a standard legend plate.

Please state the exact reference. Example: ZB2-BY2304

a special legend plate.

Please state the exact reference of the legend plate and the text required.

Example: ZB2-BY4001 "Pump 1".

For mounting within the operating heads

- flush pushbuttons
- projecting pushbuttons
- booted pushbuttons
- illuminated pushbuttons
- push to test pilot lights and pilot lights

Without text

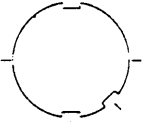

ZB2-BY1101

Universal symbols

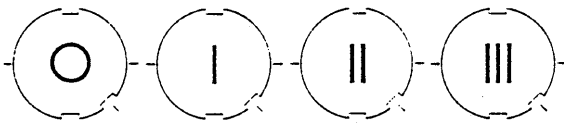

ZB2-BY1146 ZB2-BY1147 ZB2-BY1148 ZB2-BY1149

English texts

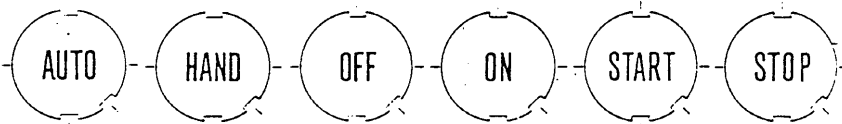







ZB2-BY1115 ZB2-BY1316 ZB2-BY1312 ZB2-BY1311 ZB2-BY1303 ZB2-BY1304

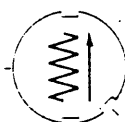
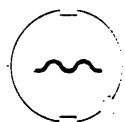
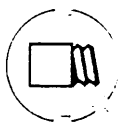
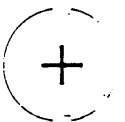

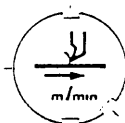
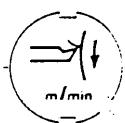
Symbols for motions and speeds

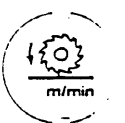
 Direction of continuous linear motion to the right ZB2-BY1912	 Direction of continuous linear motion to the left ZB2-BY1914	 Direction of continuous upward linear motion ZB2-BY1913	 Direction of continuous downward linear motion ZB2-BY1915	 Linear motion in two directions Left-Right ZB2-BY1932
 Linear motion in two directions Up-Down ZB2-BY1931	 Interrupted linear motion ZB2-BY1901	 Limited linear motion ZB2-BY1902	 Limited linear movement and return ZB2-BY1903	 Continuous oscillating linear motion ZB2-BY1904
 Continuous clockwise rotation ZB2-BY1905	 Continuous anti-clockwise rotation ZB2-BY1906	 Rotation in two directions ZB2-BY1907	 Interrupted clockwise rotation ZB2-BY1908	 Interrupted anti-clockwise rotation ZB2-BY1909
 Limited clockwise rotation ZB2-BY1910	 Limited anti-clockwise rotation ZB2-BY1911	 Limited rotary movement and return ZB2-BY1916	 Continuous oscillating movement ZB2-BY1917	 Direction of spindle rotation ZB2-BY1918
 One revolution irrespective of direction ZB2-BY1919	 Number of revolutions per minute /min ZB2-BY1920	 Feed ZB2-BY1921	 Feed, mm/revolution mm/rev ZB2-BY1922	 Feed, mm/minute mm/min ZB2-BY1923
 Reduced feed ZB2-BY1924	 Rapid feed ZB2-BY1925	 Normal feed ZB2-BY1926	 Longitudinal feed ZB2-BY1927	 Transverse feed ZB2-BY1928

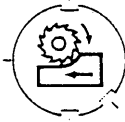

Symbols for motions and speeds (continued)

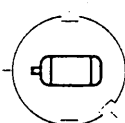
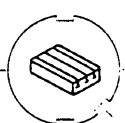
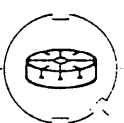
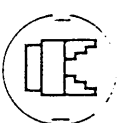
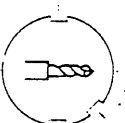
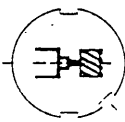
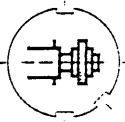
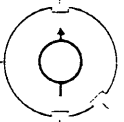
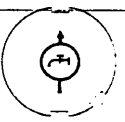
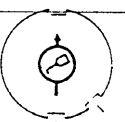
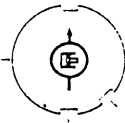
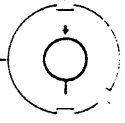
	Vertical feed		Rapid traverse		Threading		Increase of a value		Decrease of a value
ZB2-BY1929		ZB2-BY1930		ZB2-BY1933		ZB2-BY1934		ZB2-BY1935	
	Speed of planing cut		Speed of turning cut		Speed of drilling cut		Speed of milling cut		Conventional milling
ZB2-BY1936		ZB2-BY1937		ZB2-BY1938		ZB2-BY1939		ZB2-BY1940	
	Climb milling								
ZB2-BY1941									

Element symbols

	Electric motor		Rectangular work table or slide element		Round work table or rotating element		Turning spindle		Drilling spindle
ZB2-BY1942		ZB2-BY1943		ZB2-BY1944		ZB2-BY1945		ZB2-BY1946	
	Milling spindle		Grinding spindle		Pump (general symbol)		Coolant pump		Lubricant pump
ZB2-BY1947		ZB2-BY1948		ZB2-BY1949		ZB2-BY1950		ZB2-BY1951	
	Hydraulic pump		Hydraulic motor		Tracer				
ZB2-BY1952		ZB2-BY1953		ZB2-BY1954					

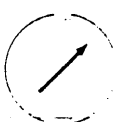
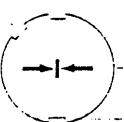
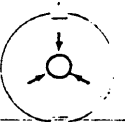
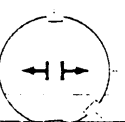
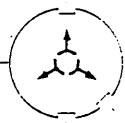
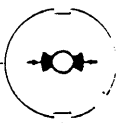
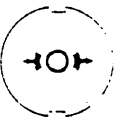
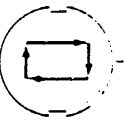
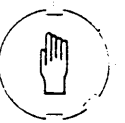
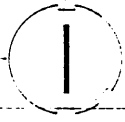
Operational symbols

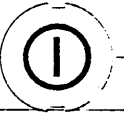
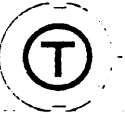
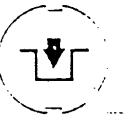
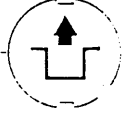
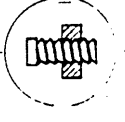
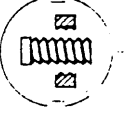
	Continuous regulation		Adjustable		Lock or tighten		Lock or tighten		Unlock, unclamp
ZB2-BY1955		ZB2-BY1956		ZB2-BY1957		ZB2-BY1958		ZB2-BY1959	
	Unlock, unclamp		Brake on		Brake off		Automatic (or semi-automatic) cycle		Hand control
ZB2-BY1960		ZB2-BY1961		ZB2-BY1962		ZB2-BY1963		ZB2-BY1964	
	ON		OFF		ON-OFF		ON, whilst pushbutton depressed		Engaging
ZB2-BY1965		ZB2-BY1966		ZB2-BY1967		ZB2-BY1968		ZB2-BY1969	
	Disengaging		Locknut closed		Locknut open				
ZB2-BY1970		ZB2-BY1971		ZB2-BY1972					

circular head, chromium plated metal bezel

Screw and captive cable clamp connections

(positions A, B, C, D are as viewed from the front of the unit)

Dimensions: see page 19
Schemes : see page 19

Complete units, type XD2-P (compact, contact blocks are not interchangeable)

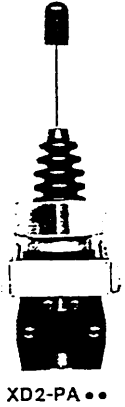

Description		Reference	Weight kg
2 direction Fixing centres 30x85mm	A — o — B	Without spring return to the zero position	XD2-PA12 0.115
		With spring return to the zero position	XD2-PA22 0.115
4 direction Fixing centres 85x85mm	<pre> D A — o — B C </pre>	Without spring return to the zero position	XD2-PA14 0.145
		With spring return to the zero position	XD2-PA24 0.145

Complete units, type XD2-G

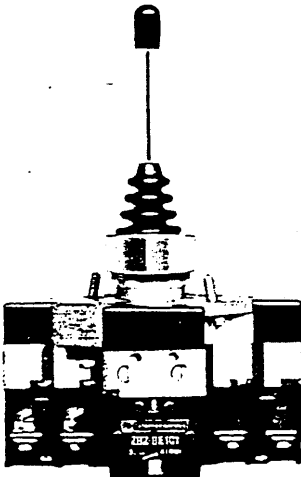

2 direction Fixing centres 90x90mm	A — o — B	2 notches with spring return to the zero position	XD2-GA8241 0.500
		2 notches: 1st notch stayput 2nd notch spring return to 1st notch	XD2-GA8251 0.500
4 direction Fixing centres 90x90mm	<pre> D A — o — B C </pre>	2 notches with spring return to the zero position	XD2-GA8441 0.555
		2 notches: 1st notch stayput 2nd notch spring return to 1st notch	XD2-GA8451 0.555

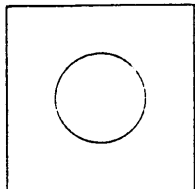
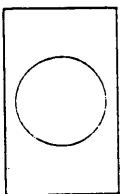

Accessories and spare parts

2 direction legend plates For XD2-PA: 30x48mm For XD2-GA: 40x64mm	Without text, black one	30x48	ZD2-GY2201	0.002
	side - red other	40x64	ZD2-GY5201	0.002
	With text*	30x48	ZD2-GY2002	0.002
	black background	40x64	ZD2-GY5002	0.002
4 direction legend plates For XD2-PA: 48x48mm For XD2-GA: 64x64mm	Without text*	30x48	ZD2-GY2004	0.002
	red background	40x64	ZD2-GY5004	0.002
	Without text, black one	48x48	ZD2-GY4201	0.003
	side - red other	64x64	ZD2-GY6201	0.003
	With text*	48x48	ZD2-GY4002	0.003
	black background	64x64	ZD2-GY6002	0.003
	With text*	48x48	ZD2-GY4004	0.003
	red background	64x64	ZD2-GY6004	0.003

*State exact text required when ordering: 2 lines of 11 characters per line max.

Spare N/O contact blocks	For controllers XD2-PA XD2-GA	Not interchangeable ZB2-BE101	0.015
--------------------------	----------------------------------	----------------------------------	-------

Other versions

Variable composition XD2-GA controllers (1 or 2 notches per direction; 1 or 2 contacts per direction).
Contacts for low power switching.
Please consult your local sales office.

When ordering



a small joystick controller
Please state the exact reference. Example: XD2-PA24.
Add the reference of the legend plate and the text required.

Dimensions of control and signalling units $\varnothing 22.2$ (fixing)

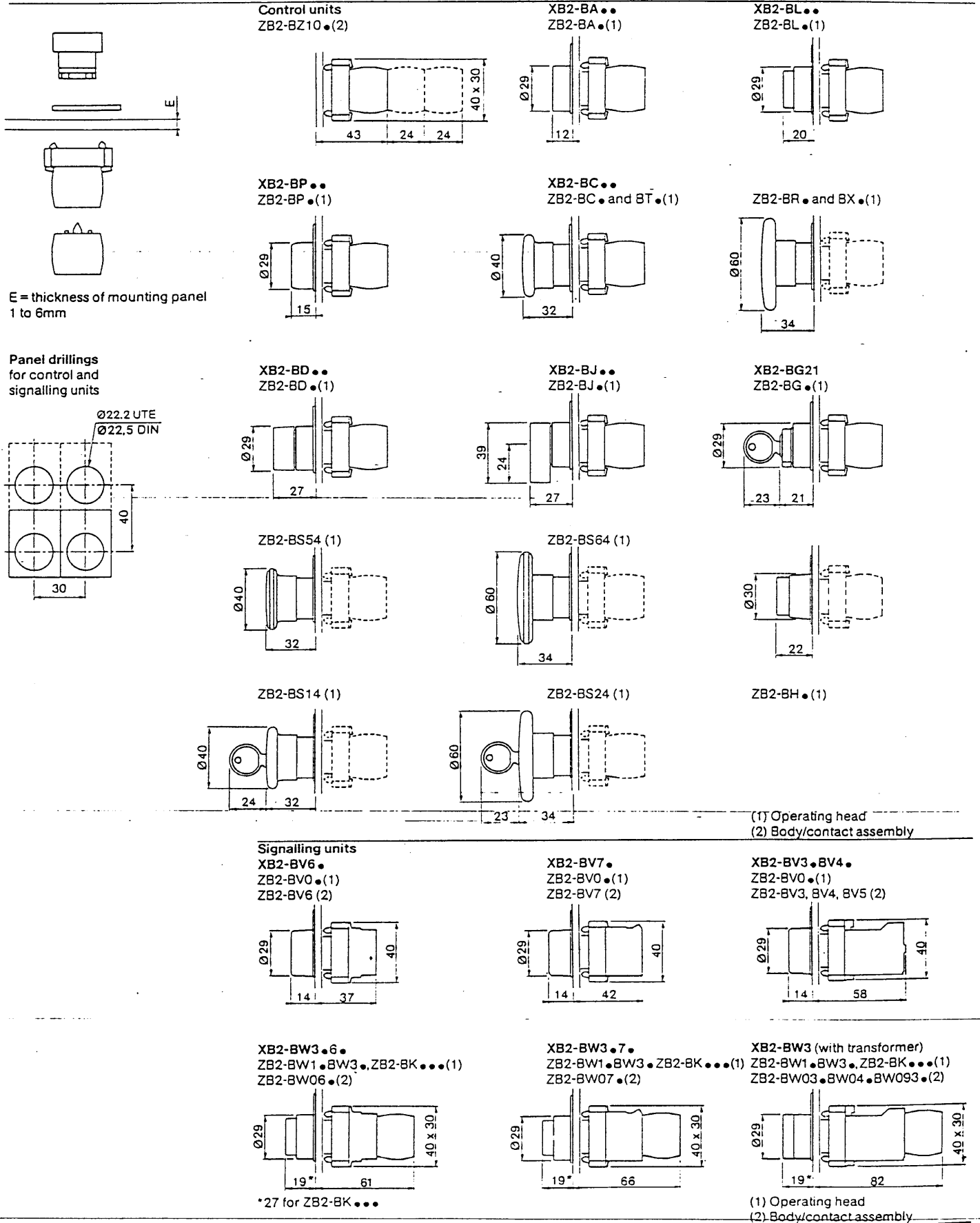

Dimensions

of double-headed pushbutton operators

References: see pages 6,7 and 11

Panel drillings
for double-headed pushbutton
operators, without pilot light

for double-headed pushbutton operators,
with pilot light without boot

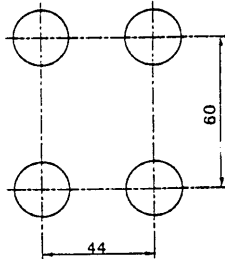
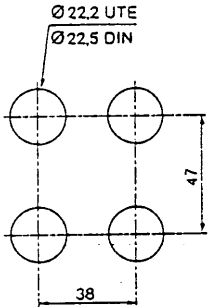

Double-headed pushbutton operators without pilot light

ZB2-BZ10● (2)

ZB2-BA● (1)

XB2-BL●●
ZB2-BL● (1)

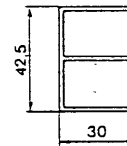
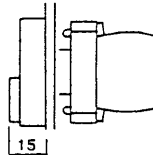
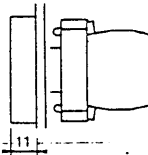
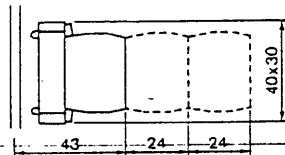

(1) Operating Head (2) Body/contact assembly

Double-headed pushbutton operators with pilot light

XB2-BW9●●● (direct)
ZB2-BW8●●●● (1)
ZB2-BW065 (2)

XB2-BW9●●● (with resistor)
ZB2-BW8●●●● (1)
ZB2-BW075 (2)

XB2-BW9●●● (with transformer)
ZB2-BW8●●●● (1)
ZB2-BW035, BW045, BW055 (2)

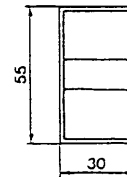
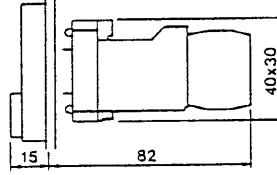
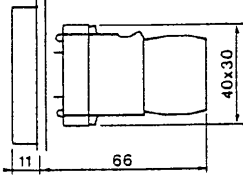
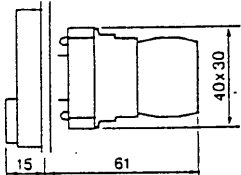

(1) Operating head (2) Body/contact assembly

Sealing boot

for double-headed pushbutton operators with pilot light (supplied fitted)

ZB2-BW008

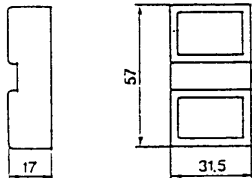

Dimensions and schemes of small joystick controllers Ø22.2 (fixing)

References: see page 16

Panel drillings for controllers XD2-PA (2 direction)

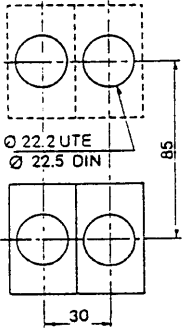

XD2-PA (4 direction)

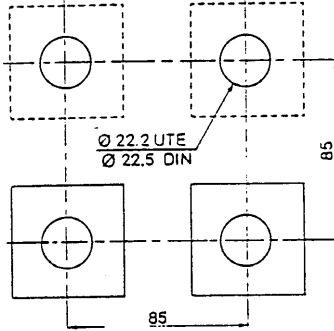

XD2-GA (2 and 4 direction)

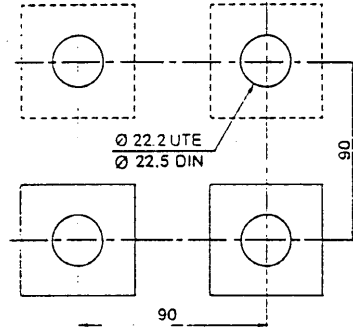

Controllers XD2-PA••

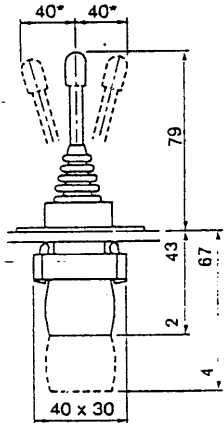

*typical for each of the 4 directions

XD2-PA12 XD2-PA22

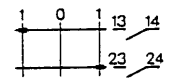
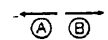
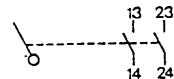
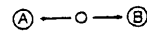

XD2-PA14 XD2-PA24

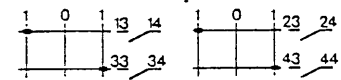
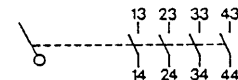
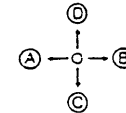

XD2-GA••

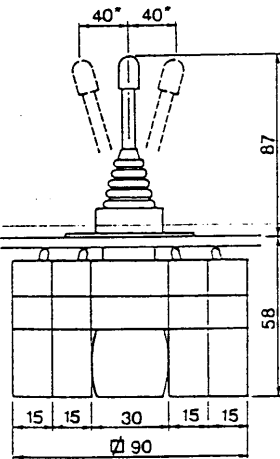

*typical for each of the 4 directions

XD2-GA8241

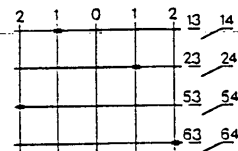
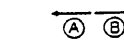
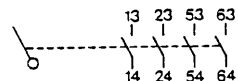
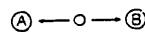

XD2-GA8251

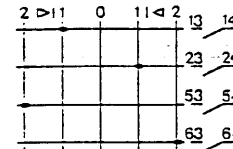
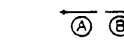
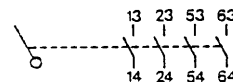
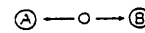

XD2-GA8441

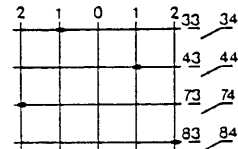
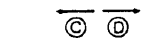
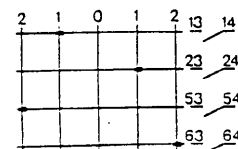
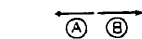
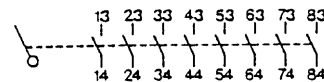
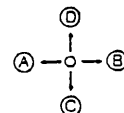

XD2-GA8451

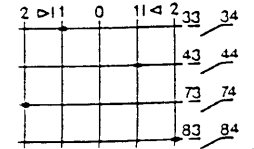
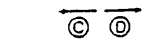
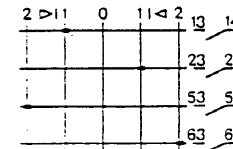
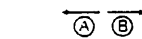
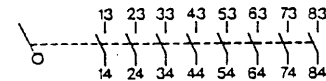
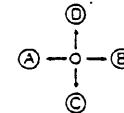



Notes :

X B 2 B | L 4 | 2
FAMILY HEAD CONTACT

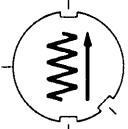
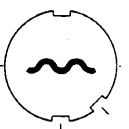
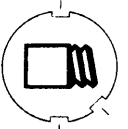
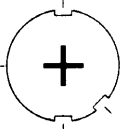
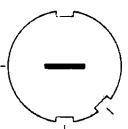
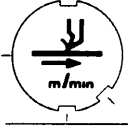
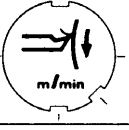
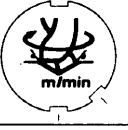
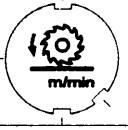
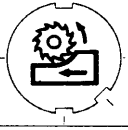

HEAD = ZB2-LB4

BODY } = ZB2-BZ102
+CONTACT }

Symbols for motions and speeds (continued)

	Vertical feed		Rapid traverse		Threading		Increase of a value		Decrease of a value
ZB2-BY1929		ZB2-BY1930		ZB2-BY1933		ZB2-BY1934		ZB2-BY1935	
	Speed of planing cut		Speed of turning cut		Speed of drilling cut		Speed of milling cut		Conventional milling
ZB2-BY1936		ZB2-BY1937		ZB2-BY1938		ZB2-BY1939		ZB2-BY1940	
	Climb milling								
ZB2-BY1941									

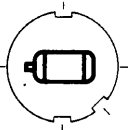
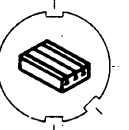
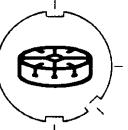
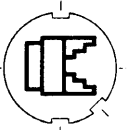
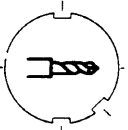
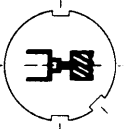
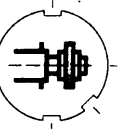
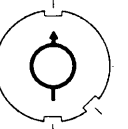
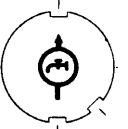
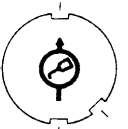
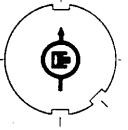
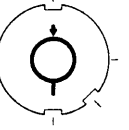
Element symbols

	Electric motor		Rectangular work table or slide element		Round work table or rotating element		Turning spindle		Drilling spindle
ZB2-BY1942		ZB2-BY1943		ZB2-BY1944		ZB2-BY1945		ZB2-BY1946	
	Milling spindle		Grinding spindle		Pump (general symbol)		Coolant pump		Lubricant pump
ZB2-BY1947		ZB2-BY1948		ZB2-BY1949		ZB2-BY1950		ZB2-BY1951	
	Hydraulic pump		Hydraulic motor		Tracer				
ZB2-BY1952		ZB2-BY1953		ZB2-BY1954					

Operational symbols

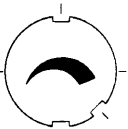
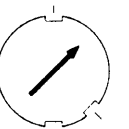
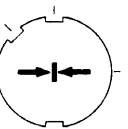
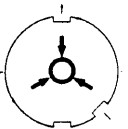
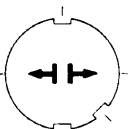
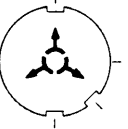
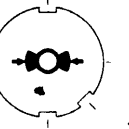
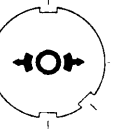
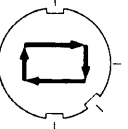
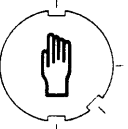
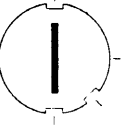
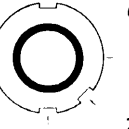
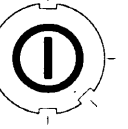
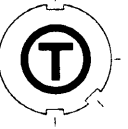
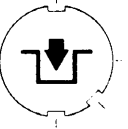
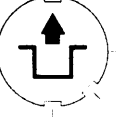
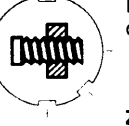
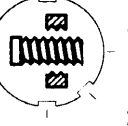
	Continuous regulation		Adjustable		Lock or tighten		Lock or tighten		Unlock, unclamp
ZB2-BY1955		ZB2-BY1956		ZB2-BY1957		ZB2-BY1958		ZB2-BY1959	
	Unlock, unclamp		Brake on		Brake off		Automatic (or semi-automatic) cycle		Hand control
ZB2-BY1960		ZB2-BY1961		ZB2-BY1962		ZB2-BY1963		ZB2-BY1964	
	ON		OFF		ON - OFF		ON, whilst pushbutton depressed		Engaging
ZB2-BY1965		ZB2-BY1966		ZB2-BY1967		ZB2-BY1968		ZB2-BY1969	
	Disengaging		Locknut closed		Locknut open				
ZB2-BY1970		ZB2-BY1971		ZB2-BY1972					

Analogue output joystick controllers Ø 22 mm (fixing)

with circular chromium plated metal bezel

Characteristics :
page 24
Output curves :
page 24
References :
page 25

Dimensions, mounting

Panel cut-out (thickness 1 to 4.5 mm)
Viewed from top of panel

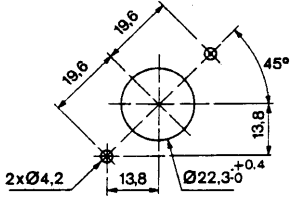

Dimensions
XDA-L11...

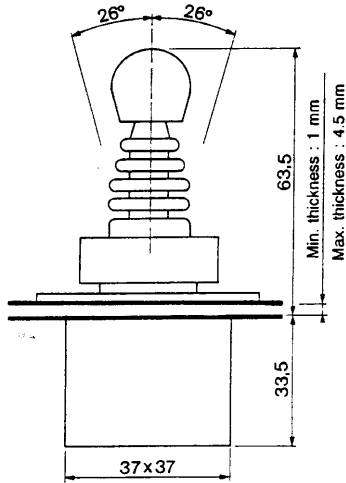

XDA-V11...

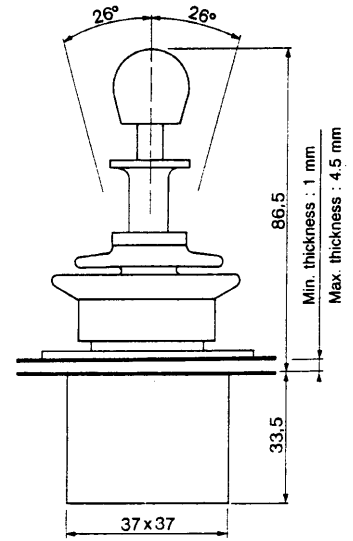

Minimum distance between 2 controllers

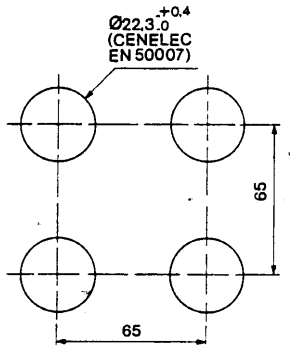

Front plate (48 x 48)

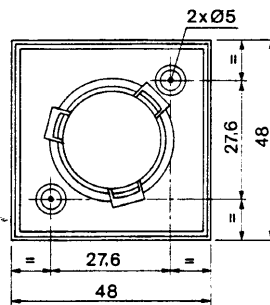

Front plate (48 x 48)

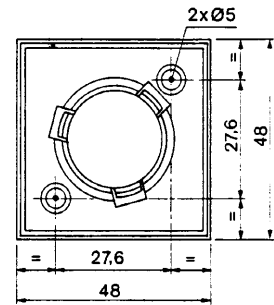

Displacement axes
One 2 direction axis

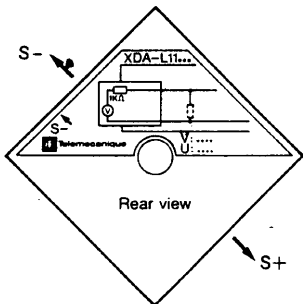

Two all direction axes

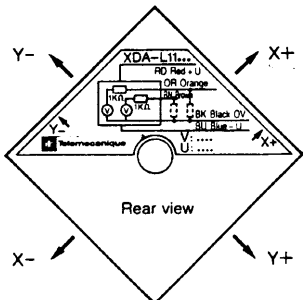

Mounting
XDA-L11...

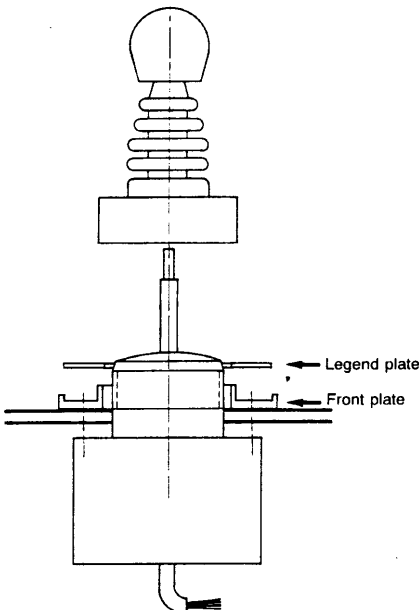

XDA-V11...

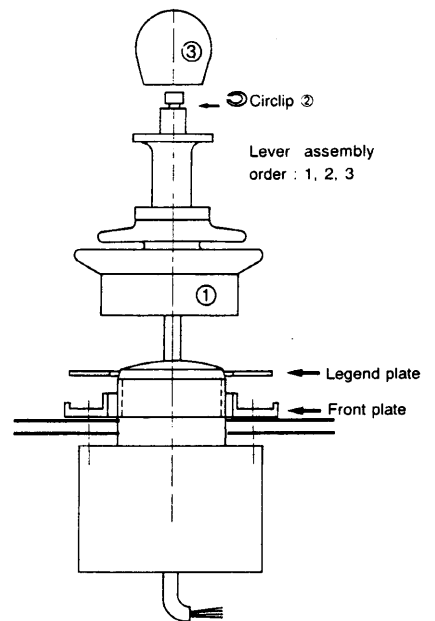



Стандарт Электрон Связь

Мы молодая и активно развивающаяся компания в области поставок электронных компонентов. Мы поставляем электронные компоненты отечественного и импортного производства напрямую от производителей и с крупнейших складов мира.

Благодаря сотрудничеству с мировыми поставщиками мы осуществляем комплексные и плановые поставки широчайшего спектра электронных компонентов.

Собственная эффективная логистика и склад в обеспечивает надежную поставку продукции в точно указанные сроки по всей России.

Мы осуществляем техническую поддержку нашим клиентам и предпродажную проверку качества продукции. На все поставляемые продукты мы предоставляем гарантию .

Осуществляем поставки продукции под контролем ВП МО РФ на предприятия военно-промышленного комплекса России , а также работаем в рамках 275 ФЗ с открытием отдельных счетов в уполномоченном банке. Система менеджмента качества компании соответствует требованиям ГОСТ ISO 9001.

Минимальные сроки поставки, гибкие цены, неограниченный ассортимент и индивидуальный подход к клиентам являются основой для выстраивания долгосрочного и эффективного сотрудничества с предприятиями радиоэлектронной промышленности, предприятиями ВПК и научно-исследовательскими институтами России.

С нами вы становитесь еще успешнее!

Наши контакты:

Телефон: +7 812 627 14 35

Электронная почта: sales@st-electron.ru

Адрес: 198099, Санкт-Петербург,
Промышленная ул, дом № 19, литера Н,
помещение 100-Н Офис 331