

Altech's Eurostrips are safe, economical and meet worldwide standards. They are a cost-effective alternative to barrier strips that require labor-intensive wire lugs and they reduce the number of electrical connections in circuits.

Eurostrips feature tubular screw clamps, wire protectors, and are ready for immediate wire hookup. Eurostrips are ideal in small spaces, which means more room for other components or reduced enclosure size. Free float or mount them onto any panel. They are available in easy-to-cut 12-pole strips or pre-cut.

Feed-Through Eurostrips are supplied with wire protectors. Offered with flat bases or standoff feet, they are molded of self-extinguishing polyamide. Custom imprinting and marking plates are available.

EUROSTRIPS®

EASY MOUNTING SAVES INSTALLATION TIME

Eurostrips are mounted quickly in panels. Use standard screws or mounting pins, offered as accessories in this section, or leave them free floating to completely eliminate mounting.

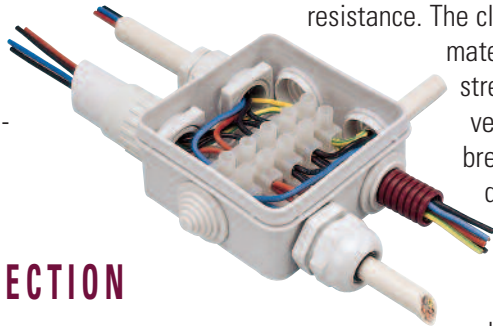

EASY CONNECTION SAVES MONEY

What could be easier? Simply strip the wire insulation, insert the wire and tighten the screw to achieve a gas-tight, electrically efficient connection—every time. Wire lugs are eliminated, saving material cost and installation time.

EASY MODIFICATION REDUCES INVENTORY

Offered in easy to cut 12 pole strips, they can also be ordered pre-cut with the required number of poles. Polyamide housing can be cut with a utility knife or hacksaw, providing flexibility to meet changing needs. Because standard 12 pole strips can be so easily cut to the required number of poles, stocking is simplified and inventory is minimized.

RELIABLE CONNECTION EVERY TIME

The basis for the Eurostrip's reliable connection is a precision machined tubular screw clamp insert made from highly conductive copper alloy which is nickel plated for maximum corrosion resistance. The clamping screw material is high

strength steel to prevent screw head breakage or thread damage. This provides trouble free operation.

Screws are electrogalvanized and

bluechromated to provide corrosion resistance. Optional nickel plated brass screws may be ordered for highly corrosive environments or marine applications.

Standard Eurostrips feature stainless steel wire protectors. Unlike wire protectors found in many competitive products which use copper alloy materials, stainless steel has superior memory characteristics. Accordingly, the wire protector will return to its original position even after repeated use. This means trouble-free wire insertion and quicker reconnections.

HOUSINGS

Eurostrip housings are injection molded from self-extinguishing polyamide 6.6 molding material, possessing high dielectric strength and excellent electrical insulation and temperature resistance. Each housing has been specially designed to provide creepage and clearance distances to achieve ratings up to 600V. Choose low profile, flat base housings for minimum clearance applications (300V) or housings with mounting feet for maximum voltage isolation (600V).

ACCESSORIES

External jumpers bus potentials between poles on Eurostrips, eliminating wire jumpers and reducing wiring time. Isolation partition increases clearance between adjacent poles and provides visual separation for more efficient wiring. Mounting pins simplify installation and mounting of Eurostrips. Simply drill the mounting hole, position and install the pin from underneath the panel. When correct position is reached, pin will retain terminal to panel.

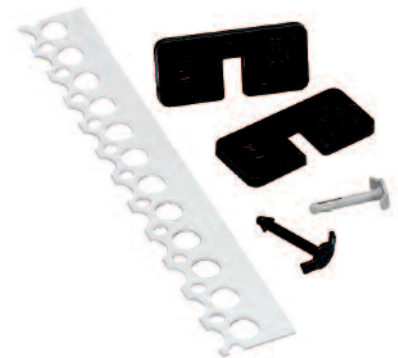

Identify circuits and reduce wiring mistakes with marking plates. Order plates imprinted or blank. Position under or on top of a Eurostrip housing.

Imprinting Eurostrips reduces wiring errors and helps to identify circuits. Use Imprinting to mark individual poles when high quantities are involved or custom imprints are required.

FEED-THROUGH FLAT BASE EUROSTRIPS Panel Mount

For wire-to-wire connections in HVAC, appliance, equipment, power distribution and other industrial applications with strict budget and space requirements. Easy to use double row terminal strips are a cost-effective alternative to barrier strips or other types of terminal blocks. Simply strip the wire, insert and tighten the screw. Eurostrips feature tubular screw clamps, with wire protectors, and recessed metal parts for finger protection. The stainless steel wire protectors exhibit excellent memory and the most effective connection.

Eurostrips described on this and the following page are available with a flat base for minimum clearance applications. They can be panel mounted or left to free float. Offered in easy to cut standard 12 pole strips, they can also be ordered precut with the required number of poles.

- Tubular screw clamp
- Panel mount or free float
- Housing material: polyamide 6.6
- Color: opaque white
- Marking plates or factory imprinted application



Flat base with wire protector



Flat base with wire protector

| | | | | |
|------------------------|-----------------------|-----------|-----------------------|-----------|
| Pole Spacing | 8 mm | | 10 mm | |
| Mounting Hole Diameter | 3 mm | | 3.6 mm | |
| Stripping Length | 5 mm | | 6 mm | |
| Approvals | | | | |
| Wire Range | 1-2.5 mm ² | 24-12 AWG | 2.5-4 mm ² | 24-10 AWG |
| Voltage Rating | 400 V | 300 V | 400V | 300 V |
| Current Rating | 6 A | 20 A | 10 A | 30 A |
| Torque | 0.5 Nm | 4.4 lb-in | 0.8 Nm | 7.0 lb-in |

| No. of Poles | Cat. No. | Std. Pk. | Cat. No. | Std. Pk. |
|--------------|-----------|----------|-----------|----------|
| 2 | HE1WPR/02 | 100 | HE4WPR/02 | 100 |
| 3 | HE1WPR/03 | 100 | HE4WPR/03 | 100 |
| 4 | HE1WPR/04 | 100 | HE4WPR/04 | 100 |
| 5 | HE1WPR/05 | 100 | HE4WPR/05 | 100 |
| 6 | HE1WPR/06 | 50 | HE4WPR/06 | 50 |
| 7 | HE1WPR/07 | 50 | HE4WPR/07 | 50 |
| 8 | HE1WPR/08 | 50 | HE4WPR/08 | 50 |
| 9 | HE1WPR/09 | 50 | HE4WPR/09 | 50 |
| 10 | HE1WPR/10 | 50 | HE4WPR/10 | 50 |
| 11 | HE1WPR/11 | 50 | HE4WPR/11 | 50 |
| 12 | HE1WPR/12 | 50 | HE4WPR/12 | 50 |

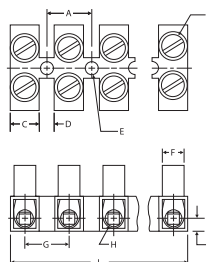

Dimensions mm

| | |
|----------|------------------|
| A = 8.0 | H = Ø2.8 |
| B = M2.6 | I = 2.8 |
| C = 5.2 | J = 6.5 |
| D = 2.8 | K = 6.5 |
| E = Ø3 | L = 94 (12 pole) |
| F = Ø5 | M = 12.2 |
| G = 8.0 | N = 16.2 |

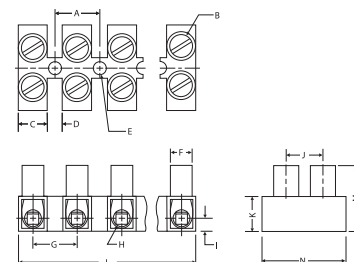

Dimensions mm

| | |
|----------|-------------------|
| A = 10.0 | H = Ø3.6 |
| B = M3 | I = 3.2 |
| C = 6.4 | J = 8.5 |
| D = 3.5 | K = 7.9 |
| E = Ø3.6 | L = 117 (12 pole) |
| F = Ø5.7 | M = 14.9 |
| G = 10.0 | N = 20.0 |

HE6

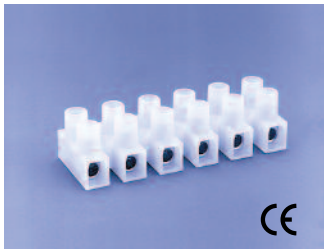

Flat base with wire protector

12 mm

4.2 mm

7 mm



4-6 mm²

20-10 AWG

400V

300 V

16 A

40 A

0.8 Nm

7.0 lb-in

| Cat. No. | Std. Pk. |
|-----------|----------|
| HE6WPR/02 | 100 |
| HE6WPR/03 | 100 |
| HE6WPR/04 | 100 |
| HE6WPR/05 | 100 |
| HE6WPR/06 | 50 |
| HE6WPR/07 | 50 |
| HE6WPR/08 | 50 |
| HE6WPR/09 | 50 |
| HE6WPR/10 | 25 |
| HE6WPR/11 | 25 |
| HE6WPR/12 | 25 |

HE10

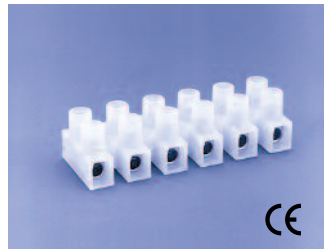

Flat base with wire protector

15 mm

4.3 / 5.7 mm

8.5 mm



6-10 mm²

18-8 AWG

400V

300 V

25 A

50 A

1.2 Nm

10.6 lb-in

| Cat. No. | Std. Pk. |
|------------|----------|
| HE10WPR/02 | 50 |
| HE10WPR/03 | 50 |
| HE10WPR/04 | 50 |
| HE10WPR/05 | 50 |
| HE10WPR/06 | 25 |
| HE10WPR/07 | 25 |
| HE10WPR/08 | 25 |
| HE10WPR/09 | 25 |
| HE10WPR/10 | 10 |
| HE10WPR/11 | 10 |
| HE10WPR/12 | 10 |

HE16

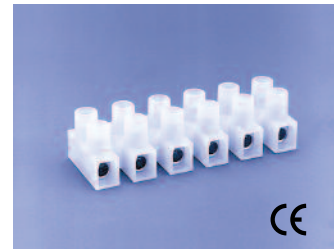

Flat base with wire protector

15 mm

4.3 / 5.7 mm

8.5 mm



10-16 mm²

18-6 AWG

400 V

300 V

35-63 A

63 A

2.0 Nm

17.7 lb-in

| Cat. No. | Std. Pk. |
|------------|----------|
| HE16WPR/02 | 50 |
| HE16WPR/03 | 50 |
| HE16WPR/04 | 50 |
| HE16WPR/05 | 50 |
| HE16WPR/06 | 25 |
| HE16WPR/07 | 25 |
| HE16WPR/08 | 25 |
| HE16WPR/09 | 25 |
| HE16WPR/10 | 10 |
| HE16WPR/11 | 10 |
| HE16WPR/12 | 10 |

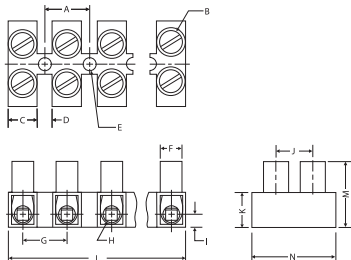

Dimensions mm

| | |
|----------|-------------------|
| A = 12.0 | H = Ø4.1 |
| B = M3.5 | I = 4.0 |
| C = 7.7 | J = 9.5 |
| D = 4.3 | K = 8.9 |
| E = Ø4.2 | L = 140 (12 pole) |
| F = Ø6.3 | M = 16.8 |
| G = 12.0 | N = 22.6 |

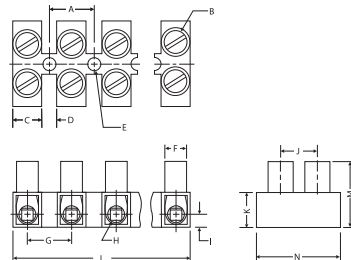

Dimensions mm

| | |
|--------------|-------------------|
| A = 15.0 | H = Ø5.0 |
| B = M4 | I = 4.8 |
| C = 9.3 | J = 11.3 |
| D = 5.7 | K = 11.6 |
| E = Ø4.3/5.7 | L = 175 (12 pole) |
| F = Ø8.2 | M = 21.9 |
| G = 15.0 | N = 25.1 |

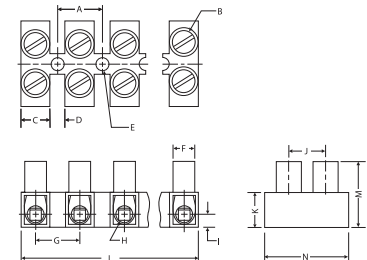

Dimensions mm

| | |
|--------------|-------------------|
| A = 15.0 | H = Ø5.6 |
| B = M5 | I = 4.8 |
| C = 9.3 | J = 11.3 |
| D = 5.7 | K = 11.6 |
| E = Ø4.3/5.7 | L = 175 (12 pole) |
| F = Ø8.2 | M = 21.9 |
| G = 15.0 | N = 25.1 |

FEED THROUGH STANDOFF FEET EUROSTRIPS Panel Mount

For wire-to-wire connections in HVAC, appliance, equipment, power distribution and other industrial applications with restricted budget and space requirements.

Easy to use feed through terminal strips are a cost-effective alternative to barrier strips or other types of terminal blocks. Simply strip the wire, insert, and tighten the screw.

Eurostrips feature tubular screw clamps, with wire protectors, and recessed metal parts for finger protection. The stainless steel wire protectors exhibit excellent memory and the most effective connection.

Eurostrips described on this and the preceding page are available with standoff feet for increased wiring efficiency. They can be panel mounted or left to free float. Offered in easy to cut 12 pole strips, they can also be ordered pre-cut with the required number of poles.

- Tubular screw clamp
- Panel mount or free float
- Housing material: polyamide 6.6
- Color: opaque white
- Marking plates or factory imprinted

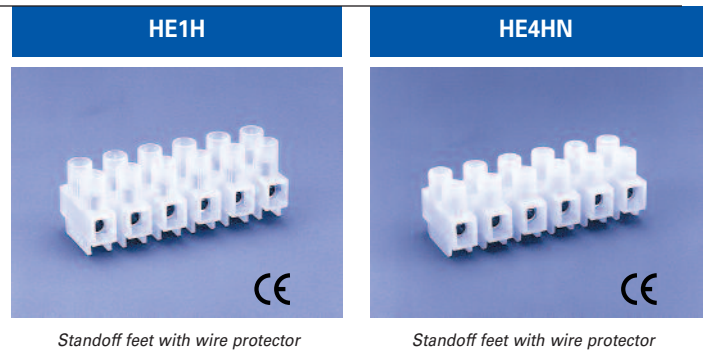

Standoff feet with wire protector

Standoff feet with wire protector

| | | | | |
|------------------------|-----------------------|-----------|-----------------------|-----------|
| Pole Spacing | 8 mm | | 10 mm | |
| Mounting Hole Diameter | 3 mm | | 3.6 mm | |
| Stripping Length | 5 mm | | 6 mm | |
| Approvals | | | | |
| Wire Range | 1-2.5 mm ² | 24-12 AWG | 2.5-4 mm ² | 24-10 AWG |
| Voltage Rating | 400 V | 600 V | 400 V | 600 V |
| Current Rating | 6 A | 20 A | 10 A | 30 A |
| Torque | 0.5 Nm | 4.4 lb-in | 0.8 Nm | 7.0 lb-in |

| No. of Poles | Cat. No. | Std. Pk. | Cat. No. | Std. Pk. |
|--------------|------------|----------|-------------|----------|
| 2 | HE1HWPR/02 | 100 | HE4HNWPR/02 | 100 |
| 3 | HE1HWPR/03 | 100 | HE4HNWPR/03 | 100 |
| 4 | HE1HWPR/04 | 100 | HE4HNWPR/04 | 100 |
| 5 | HE1HWPR/05 | 100 | HE4HNWPR/05 | 100 |
| 6 | HE1HWPR/06 | 50 | HE4HNWPR/06 | 50 |
| 7 | HE1HWPR/07 | 50 | HE4HNWPR/07 | 50 |
| 8 | HE1HWPR/08 | 50 | HE4HNWPR/08 | 50 |
| 9 | HE1HWPR/09 | 50 | HE4HNWPR/09 | 50 |
| 10 | HE1HWPR/10 | 50 | HE4HNWPR/10 | 50 |
| 11 | HE1HWPR/11 | 50 | HE4HNWPR/11 | 50 |
| 12 | HE1HWPR/12 | 50 | HE4HNWPR/12 | 50 |

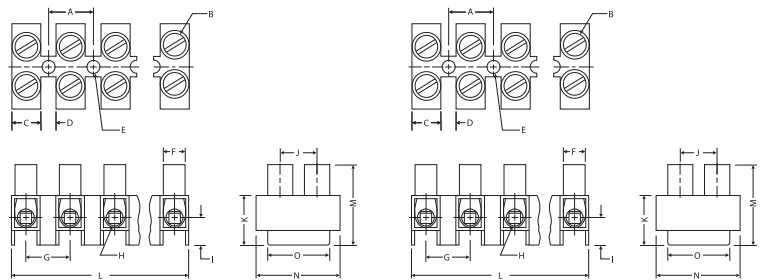

Dimensions mm

Dimensions mm

| | |
|----------|------------------|
| A = 8.0 | I = 6.6 |
| B = M2.6 | J = 6.5 |
| C = 5.2 | K = 10.3 |
| D = 2.8 | L = 94 (12 pole) |
| E = Ø3 | M = 16 |
| F = Ø5 | N = 16.2 |
| G = 8.0 | O = 10.1 |
| H = Ø2.8 | |

| | |
|----------|-------------------|
| A = 10.0 | I = 6.7 |
| B = M3 | J = 8.5 |
| C = 6.4 | K = 12.1 |
| D = 3.5 | L = 117 (12 pole) |
| E = Ø3.6 | M = 19.1 |
| F = Ø5.7 | N = 20 |
| G = 10.0 | O = 14.0 |
| H = Ø3.6 | |

HE6H

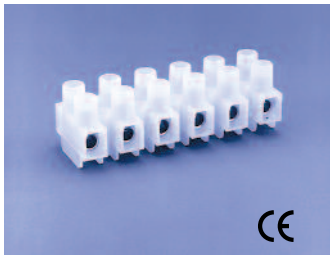

Standoff feet with wire protector

12 mm

4.2 mm

7 mm



4-6 mm²

20-10 AWG

400 V

600 V

16 A

40 A

0.8 Nm

7.0 lb-in

HE10H

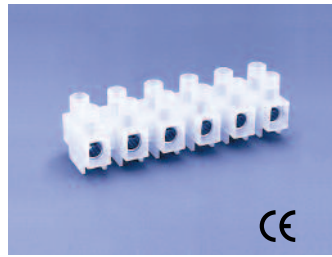

Standoff feet with wire protector

15 mm

4.3/5.7 mm

8.5 mm



6-10 mm²

18-8 AWG

400 V

600 V

25 A

50 A

1.2 Nm

10.6 lb-in

HE16H

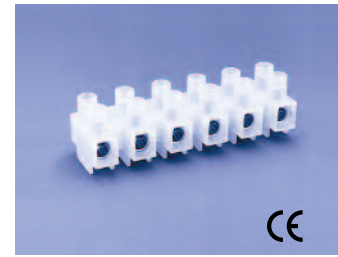

Standoff feet with wire protector

15 mm

4.3/5.7 mm

8.5 mm



10-16 mm²

18-6 AWG

400 V

600 V

35-63 A

63 A

2.0 Nm

17.7 lb-in

| Cat. No. | Std. Pk. |
|------------|----------|
| HE6HWPR/02 | 100 |
| HE6HWPR/03 | 100 |
| HE6HWPR/04 | 100 |
| HE6HWPR/05 | 100 |
| HE6HWPR/06 | 50 |
| HE6HWPR/07 | 50 |
| HE6HWPR/08 | 50 |
| HE6HWPR/09 | 50 |
| HE6HWPR/10 | 25 |
| HE6HWPR/11 | 25 |
| HE6HWPR/12 | 25 |

| Cat. No. | Std. Pk. |
|-------------|----------|
| HE10HWPR/02 | 40 |
| HE10HWPR/03 | 40 |
| HE10HWPR/04 | 40 |
| HE10HWPR/05 | 40 |
| HE10HWPR/06 | 20 |
| HE10HWPR/07 | 20 |
| HE10HWPR/08 | 20 |
| HE10HWPR/09 | 10 |
| HE10HWPR/10 | 10 |
| HE10HWPR/11 | 10 |
| HE10HWPR/12 | 10 |

| Cat. No. | Std. Pk. |
|-------------|----------|
| HE16HWPR/02 | 40 |
| HE16HWPR/03 | 40 |
| HE16HWPR/04 | 40 |
| HE16HWPR/05 | 40 |
| HE16HWPR/06 | 20 |
| HE16HWPR/07 | 20 |
| HE16HWPR/08 | 20 |
| HE16HWPR/09 | 10 |
| HE16HWPR/10 | 10 |
| HE16HWPR/11 | 10 |
| HE16HWPR/12 | 10 |

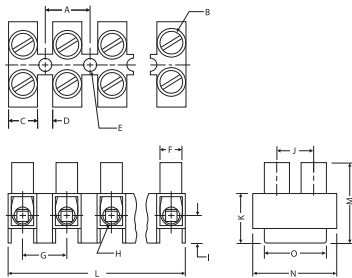

Dimensions mm

A = 12.0
B = M3.5
C = 7.7
D = 4.3
E = Ø4.2
F = Ø6.3
G = 12.0
H = Ø4.1
I = 9
J = 9.6
K = 13.9
L = 140 (12 pole)
M = 21.8
N = 22.6
O = 15

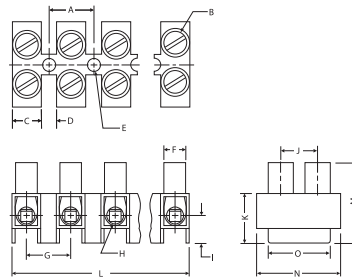

Dimensions mm

A = 15.0
B = M4
C = 9.3
D = 5.7
E = Ø4.3/5.7
F = Ø8.2
G = 15.0
H = Ø5.0
I = 10.7
J = 11.3
K = 17.5
L = 175 (12 pole)
M = 27.8
N = 25.1
O = 16

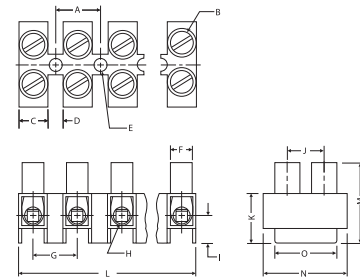

Dimensions mm

A = 15.0
B = M5
C = 9.3
D = 5.7
E = Ø4.3/5.7
F = Ø8.2
G = 15.0
H = Ø5.6
I = 10.7
J = 11.3
K = 17.5
L = 175 (12 pole)
M = 27.8
N = 25.1
O = 16

PLUGGABLE EUROSTRIPS Panel Mount

For wire-to-wire connections in HVAC, appliance, equipment, power and other distribution applications. Pluggable Eurostrips® speed and simplify replacement of subassemblies, etc. They reduce downtime and misconnections.

Two-piece pluggable terminal strips feature tubular screw clamps, with recessed metal parts for finger protection. A spring loaded contact prevents inadvertent unplugging.

The headers and plugs are available with flat base or standoff feet and can be panel mounted or free float. Offered in easy to cut 12 pole strips, they can also be orderd precut with the required number of poles.

- Tubular Screw Clamp
- Panel Mount or Free Float
- Housing Material: Polyamide 6.6
- Color: Opaque White

FLAT BASE

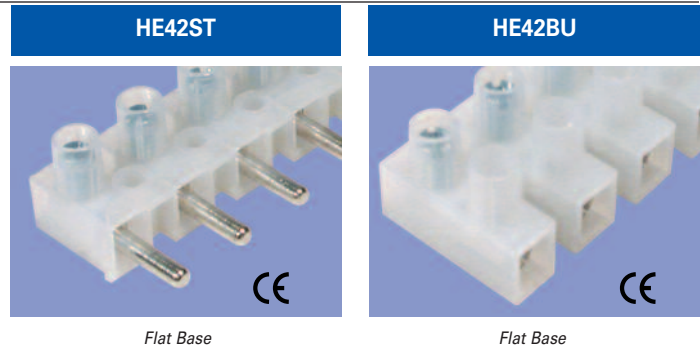

Flat Base

Flat Base

| | | | | |
|------------------------|--|----------|---|----------|
| Pole Spacing | 10 mm | | 10 mm | |
| Mounting Hole Diameter | 3.5 mm | | 3.5 mm | |
| Stripping Length | 3.6 mm | | 3.6 mm | |
| Approvals |  | |  | |
| Wire Range | 2.5-4mm ² | 24-10AWG | 2.5-4mm ² | 24-10AWG |
| Voltage Rating | 400V | 300V | 400V | 300V |
| Current Rating | 10A | 20A | 10A | 20A |
| Torque | 0.8Nm | 7.2lb | 0.8Nm | 7.2lb |

| No. of Poles | Cat. No. | Std. Pk. | Cat. No. | Std. Pk. |
|--------------|-----------|----------|-----------|----------|
| 2 | HE42ST/02 | 100 | HE42BU/02 | 100 |
| 3 | HE42ST/03 | 100 | HE42BU/03 | 100 |
| 4 | HE42ST/04 | 100 | HE42BU/04 | 100 |
| 5 | HE42ST/05 | 100 | HE42BU/05 | 100 |
| 6 | HE42ST/06 | 50 | HE42BU/06 | 50 |
| 7 | HE42ST/07 | 50 | HE42BU/07 | 50 |
| 8 | HE42ST/08 | 50 | HE42BU/08 | 50 |
| 9 | HE42ST/09 | 50 | HE42BU/09 | 50 |
| 10 | HE42ST/10 | 50 | HE42BU/10 | 50 |
| 11 | HE42ST/11 | 50 | HE42BU/11 | 50 |
| 12 | HE42ST/12 | 50 | HE42BU/12 | 50 |

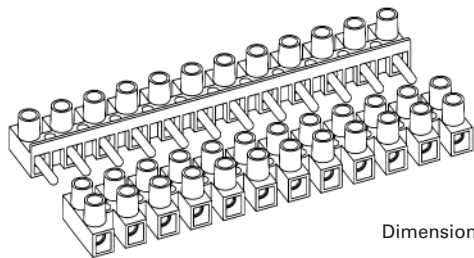

Dimensions mm

| | |
|----------|----------|
| A = 10.0 | J = 15.2 |
| B = M3 | K = 7.9 |
| C = 6.4 | L = 117 |
| D = 3.6 | M = 14.9 |
| E = Ø3.5 | N = 34.4 |
| F = Ø5.7 | O = 9.2 |
| G = 10.0 | P = 20 |
| H = Ø3.5 | Q = 14.4 |
| I = 3.2 | R = 7 |

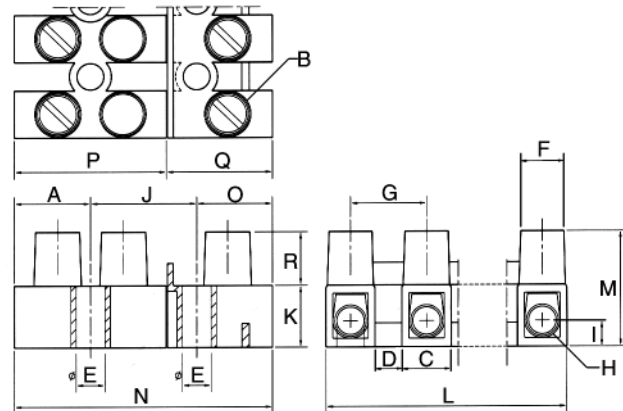

STANDOFF FEET

HE42SST

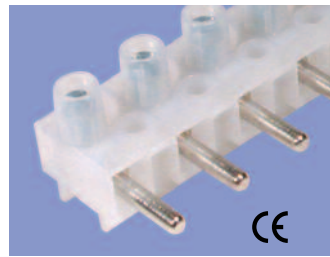

Standoff feet

HE42SBU



Standoff feet

| | | |
|------------------------|---|---|
| Pole Spacing | 10 mm | 10 mm |
| Mounting Hole Diameter | 3.5 mm | 3.5 mm |
| Stripping Length | 3.6 mm | 3.6 mm |
| Approvals |   |   |
| Wire Range | 2.5-4mm ² 24-10AWG | 2.5-4mm ² 24-10AWG |
| Voltage Rating | 400V 600V | 400V 600V |
| Current Rating | 10A 20A | 10A 20A |
| Torque | 0.8Nm 7.2lb | 0.8Nm 7.2lb |

| No. of Poles | Cat. No. | Std. Pk. | Cat. No. | Std. Pk. |
|--------------|------------|----------|------------|----------|
| 2 | HE42SST/02 | 100 | HE42SBU/02 | 100 |
| 3 | HE42SST/03 | 100 | HE42SBU/03 | 100 |
| 4 | HE42SST/04 | 100 | HE42SBU/04 | 100 |
| 5 | HE42SST/05 | 100 | HE42SBU/05 | 100 |
| 6 | HE42SST/06 | 50 | HE42SBU/06 | 50 |
| 7 | HE42SST/07 | 50 | HE42SBU/07 | 50 |
| 8 | HE42SST/08 | 50 | HE42SBU/08 | 50 |
| 9 | HE42SST/09 | 50 | HE42SBU/09 | 50 |
| 10 | HE42SST/10 | 50 | HE42SBU/10 | 50 |
| 11 | HE42SST/11 | 50 | HE42SBU/11 | 50 |
| 12 | HE42SST/12 | 50 | HE42SBU/12 | 50 |

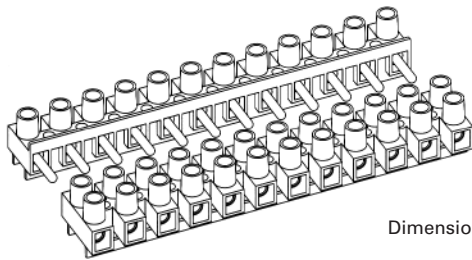

Dimensions mm

| | |
|----------|----------|
| A = 10.0 | J = 15.2 |
| B = M3 | K = 11.5 |
| C = 6.4 | L = 117 |
| D = 3.6 | M = 18.5 |
| E = Ø3.5 | N = 34.4 |
| F = Ø5.7 | O = 9.2 |
| G = 10.0 | P = 20 |
| H = Ø3.5 | Q = 14.4 |
| I = 6.8 | R = 7 |

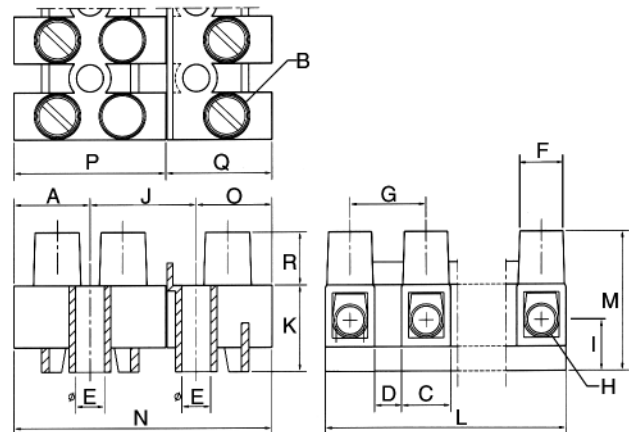

EUROSTRIP ACCESSORIES

Convenient options that facilitate installation and wire termination.

External Jumpers

Bus potentials between poles on Eurostrip Terminal Strips reducing wiring time and eliminating wire jumpers.

Jumper Pole positions may be removed to provide selective jumpering. When using external jumpers, the terminal's rated cross section is usually reduced one wire size. For jumper maximum current ratings, refer to the corresponding Eurostrip IEC/VDE current rating.

- Material: copper alloy, nickel plated
- Insulation: polyamide 6.6
- Color: black.

EXTERNAL JUMPERS



| External Jumper | HCL8 | HCL10 | HCL12 | HCL15 | | | | |
|----------------------|------------|------------------|--------------|------------------|----------|----------|----------|----------|
| Eurostrip | HE1 | HE4 | HE6 | HE10, HE16 | | | | |
| Pole Spacing | 8mm (.315) | 10 mm (.394 in.) | 12 mm (.472) | 15 mm (.591 in.) | | | | |
| Ordering Information | Cat. No. | Std. Pk. | Cat. No. | Std. Pk. | Cat. No. | Std. Pk. | Cat. No. | Std. Pk. |
| 2 pole | HCL8-2 | 100 | HCL10-2 | 100 | HCL12-2 | 100 | HCL15-2 | 100 |
| 3 pole | HCL8-3 | 100 | HCL10-3 | 100 | HCL12-3 | 100 | HCL15-3 | 100 |
| 4 pole | HCL8-4 | 100 | HCL10-4 | 100 | HCL12-4 | 100 | HCL15-4 | 100 |
| 12 pole | HCL8-12 | 25 | HCL10-12 | 25 | HCL12-12 | 25 | HCL15-12 | 25 |

Isolation Partitions

Isolation Partition KA provides separation between adjacent poles of different potentials on 600V Eurostrips with standoff feet. Visual separation between poles is also provided by an isolation partition, assisting circuit identification and increasing wiring efficiency

- Material: polyamide 6.6
- Color: black

ISOLATION PARTITION

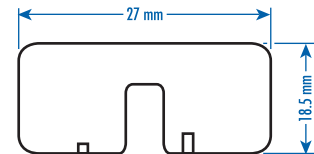
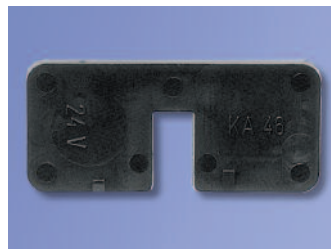

| Isolation Partition | KA46 | |
|----------------------|-------------------|----------|
| Eurostrip | HE4HN, HE6H | |
| Thickness | 3.4 mm (.134 in.) | |
| Ordering Information | Cat. No. | Std. Pk. |
| | HEP4/6H | 5 |

EUROSTRIP ACCESSORIES

Convenient options that facilitate installation and wire termination.

Mounting Pins

Speed panel mounting of Eurostrips with Mounting Pins. Simply match drill clearance hole in panel, position Eurostrip and install Mounting Pin through hole and into mounting hole in Eurostrip housing. Once pin passes beyond Eurostrip housing, it automatically expands, securing housing to panel. Use two or more mounting pins per Eurostrip.

- Material: polycarbonate
- Color: gray.

Marking Plates

Install Marking Plate MP under or on top of Eurostrip housing to identify individual pole positions to increase wiring efficiency, save installation time and facilitate wire hook-up, system modification and trouble shooting. Select blank marking plate for hand marking or imprinted.

- Material: self-extinguishing PVC
- Color: white with black imprint.

Imprinting

Mark individual pole positions to save installation time and facilitate wire hook-up, system modification and trouble shooting. Choose turret marking for optimum identification. To order imprinting specify consecutive, identical or custom character imprints.

- Imprints: rub-resistant, black ink.

MOUNTING PINS

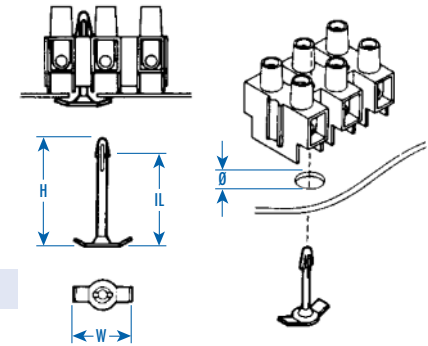

| | | | | |
|----------------------|------------|------------|----------|----------|
| Mounting Pins | H4 | H6 | | |
| Eurostrip | HE4HN | HE6H | | |
| Panel Thickness | 0.5-1.5 mm | 0.8-1.8 mm | | |
| Ordering Information | Cat. No. | Std. Pk. | Cat. No. | Std. Pk. |
| | H4 | 50 | H6 | 50 |

| Mounting Pin Type | Dimensions mm (in.) | | | |
|-------------------|---------------------|-----------------------|-----------------|-----------|
| | Pin Height (H) | Insertion Length (IL) | Panel Hole Dia. | Width (W) |
| H4 | 21 | 12.6 | 4.2 | 8.5 |
| H6 | 24 | 14.7 | 5.2 | 11 |

MARKING PLATES



| Eurostrip | HE4, HE4HN | | | HE6, HE6H | | | HE10, HE10H, HE16, HE16H | | |
|----------------------|-------------|-----------|----------|-------------|-----------|----------|--------------------------|-----------|----------|
| Ordering Information | Cat. No. | Desc. | Std. Pk. | Cat. No. | Desc. | Std. Pk. | Cat. No. | Desc. | Std. Pk. |
| | BS24E | Blank | 25 | BS60E | Blank | 25 | BS1016E | Blank | 25 |
| | BS24EM1-12 | No. 1-12 | 25 | BS60EM1-12 | No. 1-12 | 25 | BS1016EM1-12 | No. 1-12 | 25 |
| | BS24EM13-24 | No. 13-24 | 25 | BS60EM13-24 | No. 13-24 | 25 | BS1016EM13-24 | No. 13-24 | 25 |

IMPRINTING



Turret Location

| | | |
|---------------------|--|----------|
| Imprint | Turret Location | |
| Marking Instruction | Consecutive, imprint 1 through 12, Turret Location | |
| Ordering Example | Cat. No. | Std. Pk. |
| | HE4WPR/1211-12 | 1000 |



Стандарт Электрон Связь

Мы молодая и активно развивающаяся компания в области поставок электронных компонентов. Мы поставляем электронные компоненты отечественного и импортного производства напрямую от производителей и с крупнейших складов мира.

Благодаря сотрудничеству с мировыми поставщиками мы осуществляем комплексные и плановые поставки широчайшего спектра электронных компонентов.

Собственная эффективная логистика и склад в обеспечивает надежную поставку продукции в точно указанные сроки по всей России.

Мы осуществляем техническую поддержку нашим клиентам и предпродажную проверку качества продукции. На все поставляемые продукты мы предоставляем гарантию .

Осуществляем поставки продукции под контролем ВП МО РФ на предприятия военно-промышленного комплекса России , а также работаем в рамках 275 ФЗ с открытием отдельных счетов в уполномоченном банке. Система менеджмента качества компании соответствует требованиям ГОСТ ISO 9001.

Минимальные сроки поставки, гибкие цены, неограниченный ассортимент и индивидуальный подход к клиентам являются основой для выстраивания долгосрочного и эффективного сотрудничества с предприятиями радиоэлектронной промышленности, предприятиями ВПК и научно-исследовательскими институтами России.

С нами вы становитесь еще успешнее!

Наши контакты:

Телефон: +7 812 627 14 35

Электронная почта: sales@st-electron.ru

Адрес: 198099, Санкт-Петербург,
Промышленная ул, дом № 19, литера Н,
помещение 100-Н Офис 331