

## MAX14748

## USB Type-C Charger

### General Description

The MAX14748 USB battery charger integrates a charger detector, boost/buck converter, and Li+ battery charger with smart power selector to provide fast and safe charging of 2s Li+ battery packs.

The MAX14748 provides support for devices functioning as a UFP/DRP per the USB Type-C 1.1 standard, while also providing detection of legacy USB Battery Charging Specification, Revision 1.2 (BC1.2) compliant chargers in addition to other nonstandard chargers. The programmable Automatic Input Current Limiting (AICL) feature ensures that maximum safe current is drawn from the charging adapter.

The Li+ charger includes an automatic Smart Power Selector™ to simultaneously charge the battery and provide power to the system load. The Smart Power Selector function will supplement the system power with the battery if power from the charging adapter is insufficient. The Li+ charger features JEITA thermal monitoring and charger voltage/current reduction or charger disable.

The MAX14748 is available in a 54-bump, 0.4mm pitch, 3.97mm x 2.77mm x 0.64mm wafer-level package (WLP) and operates over the -40°C to +85°C extended temperature range.

### Applications

- Digital Imaging (DSC, DVC)
- Wireless Speakers
- Handheld Barcode Readers

**Ordering Information** appears at end of data sheet.

### Benefits and Features

- Minimize Power Management Footprint Through High Integration
  - 13mΩ (typ) Integrated Battery To System Switch
  - Thermal Current Limiting
  - DC-DC Converter with Boost and Reverse Buck
  - High Efficiency
    - 92% in Boost Mode at 1A Output Current and 7.4V Battery Voltage
    - 94% in Reverse Buck Mode at 500mA Output
  - Internal USB Switch for USB D+/D- Data Lines
- Easy-to-Implement Li+ Battery Charging
  - Charges 2s Li-Ion Batteries from Legacy 5V USB Adapters
    - 15W Input Power with 3A Type-C Adapter
    - 7.5W Input Power with DCP Adapter
    - 1A System/Charge Current From DCP Adapter
    - 2A System/Charge Current From 3A Type-C Adapter
  - DRP Mode USB Type-C Specification, Rev 1.1 Compliant
  - UFP Mode USB Type-C Specification, Rev 1.1 Support
  - VCONN and Super-Speed Multiplexer Logic Controls
  - Non-Standard DCP Detection
  - USB Battery Charging Specification, Rev 1.2 Compliant
- Automatic Input Current Limit (AICL) Power Management
- Support Weak/Dead Batteries Detection
  - Smart Power Selector
  - Thermistor Monitor
- Various Protection Features
  - 28V Integrated Overvoltage Protection
  - JEITA Charge Protection
  - ±15kV ESD Protection on USB Adapter Pins

*Smart Power Selector is a trademark of Maxim Integrated Products, Inc.*

### Absolute Maximum Ratings

Voltages Referenced to GND

|   |                                    |
|---|------------------------------------|
| CHGIN .....   | -0.3V to +30V                      |
| BST .....   | -0.3V to +16V                      |
| SYS to BAT .....  | -0.3V to +12V                      |
| BAT, SYS .....  | -0.3V to +12V                      |
| BYP to CHGIN .....  | -30V to +0.3V                      |
| BYP, THM, INT, SYSOK, FLTIN, FSUS,<br>LED, SDA, SCL .....   | -0.3V to 6V                        |
| COMP, SET .....   | -0.3V to V <sub>CCINT</sub> + 0.3V |
| CC1, CC2, TDN, TDP, CDN, CDP, V <sub>CONN</sub> .....       | -0.3V to +6V                       |
| CC1, CC2, in fault mode through a 10k resistor ..           | -0.3V to +20V                      |
| CDIR .....  | -0.3V to +6V                       |
| VTPU (VTPU-TPU switch open) .....                           | -0.3V to V <sub>CCINT</sub> + 0.3V |
| TPU (VTPU-TPU switch open) .....                            | -0.3V to 6 or VTPU + 0.3V          |
| VTPU, TPU Maximum Current<br>(VTPU-TPU switch closed) ..... | -100mA to +100mA                   |
| BVCEN .....   | -0.3V to V <sub>CCINT</sub> + 0.3V |

|   |   |
|---|---|
| SFOUT, V <sub>CCINT</sub> , BREG .....  | -0.3V to min ((V <sub>CHGIN</sub> + 0.3), 6)V |
| LX .....  | -0.3V to V <sub>SYS</sub> + 0.3V              |
| NVP .....   | -0.3V to +30V                                 |
| AGND, DGND, PGND, GND .....   | -0.3V to +0.3V                                |
| Continuous Current into   |   |
| CHGIN, SYS .....  | +6.4A   |
| BAT .....   | +4.8A   |
| Any Other Terminal.....   | +100mA  |
| Continuous Power Dissipation<br>(multilayer board at +70°C): 9 x 6 Array 54-Bump,<br>3.97mm x 2.77mm 0.4mm Pitch WLP<br>(derate 24.46mW/°C) ..... | 1.957W  |
| Operating Temperature Range .....   | -40°C to +85°C                                |
| Junction Temperature .....  | +150°C  |
| Storage Temperature Range .....   | -65°C to +150°C                               |
| Lead Temperature (soldering, 10s) .....   | +300°C  |
| Soldering Temperature (reflow) .....  | +260°C  |

Stresses beyond those listed under "Absolute Maximum Ratings" may cause permanent damage to the device. These are stress ratings only, and functional operation of the device at these or any other conditions beyond those indicated in the operational sections of the specifications is not implied. Exposure to absolute maximum rating conditions for extended periods may affect device reliability.

### Package Information

|  |  |
|--|--|
| <b>PACKAGE TYPE: 54 WLP</b>                |  |
| Package Code                               | W151G2+1                                       |
| Outline Number                             | <a href="#">21-100122</a>                      |
| Land Pattern Number                        | Refer to <a href="#">Application Note 1891</a> |
| <b>THERMAL RESISTANC, FOUR-LAYER BOARD</b> |  |
| Junction to Ambient (θ <sub>JA</sub> )     | 40.88°C/W                                      |

For the latest package outline information and land patterns (footprints), go to [www.maximintegrated.com/packages](http://www.maximintegrated.com/packages). Note that a "+", "#", or "-" in the package code indicates RoHS status only. Package drawings may show a different suffix character, but the drawing pertains to the package regardless of RoHS status.

Package thermal resistances were obtained using the method described in JEDEC specification JESD51-7, using a four-layer board. For detailed information on package thermal considerations, refer to [www.maximintegrated.com/thermal-tutorial](http://www.maximintegrated.com/thermal-tutorial).

## Electrical Characteristics

( $V_{BAT} = 8.3V$ ,  $T_A = -40^{\circ}C$  to  $+85^{\circ}C$ , all registers in their default state, unless otherwise noted. Typical values are at  $V_{CHGIN} = 5.0V$ ,  $V_{BAT} = 7.4V$ ,  $T_A = +25^{\circ}C$ .) (Note 1)

| PARAMETER                             | SYMBOL            | CONDITIONS   | MIN  | TYP  | MAX  | UNITS     |
|---------------------------------------|-------------------|--|------|------|------|-----------|
| <b>SUPPLY CURRENT</b>                 |                   |  |      |      |      |           |
| BAT Supply Current                    | $I_{BAT}$         | $V_{CHGIN} = 0V$ or Floating, Type-C detection active  |      | 140  |      | $\mu A$   |
|                                       |                   | Low Power mode   |      | 25   |      | $\mu A$   |
| CHGIN Supply Current                  | $I_{CHG}$         | $V_{CHGIN} = +5V$ , $T_A +25^{\circ}C$ , ChgEn = 0   |      | 5.3  |      | mA        |
|                                       |                   | $V_{CHGIN} = +5V$ , $T_A +25^{\circ}C$ , Suspend Mode (FSUS = High)  |      | 0.98 |      | mA        |
| <b>CHGIN TO BYP PATH</b>              |                   |  |      |      |      |           |
| Allowed CHGIN Input Voltage Range     | $V_{CHGIN\_RNG}$  |  | 0    |      | 28   | V         |
| CHGIN Detect Threshold                | $V_{BDET}$        | Rising   | 3.8  | 3.9  | 4.0  | V         |
|                                       | $V_{BDET\_F}$     | Falling  | 3.6  | 3.7  | 3.8  |           |
| CHGIN Overvoltage Threshold           | $V_{OVP}$         | Rising   | 5.59 | 5.66 | 5.72 | V         |
|                                       | $V_{OVP\_F}$      | Falling  | 5.56 |      |      | V         |
|                                       | $V_{OVP\_H}$      | Hysteresis   |      | 28   |      | mV        |
| CHGIN-BYP Resistance                  | $R_{CHGIN\_BYP}$  | $V_{CHGIN} = 5V$   |      | 45   |      | $m\Omega$ |
| CHGIN-BYP Soft-Start Timeout          | $t_{BYP\_SFTTO}$  | If $V_{BYP}$ has not reached within 50mV of $V_{CHGIN}$ at timeout, a fault is flagged by SysFlt of register 0x02. |      | 100  |      | ms        |
| CHGIN-BYP Soft-Start Current          | $I_{BYP\_SFT}$    |  |      | 60   |      | mA        |
| CHGIN-BYP Soft-Start End Comparator   | $V_{BYP\_SFTEND}$ |  | 15   | 50   | 80   | mV        |
| CHGIN-BYP Overload Comparator         | $V_{BYP\_OVL}$    |  | 290  | 360  | 420  | mV        |
| Input Current Limit                   | $I_{LIM}$         | SpvChgILim[4:0] = 00100  |      | 0.4  |      | A         |
|                                       |                   | SpvChgILim[4:0] = 01110  |      | 1.5  |      |           |
|                                       |                   | SpvChgILim[4:0] = 11101  |      | 3    |      |           |
| Input Current Limit Programming Range | $I_{LIM\_RNG}$    |  | 0.1  |      | 3    | A         |
| Input Current Limit Programming Step  | $I_{LIM\_STEP}$   |  |      | 100  |      | mA        |
| <b>INTERNAL SUPPLIES</b>              |                   |  |      |      |      |           |
| Internal $V_{CCINT}$ Regulator        | $V_{CCINT}$       | $V_{CHGIN} = 5V$ , boost off   | 4.0  | 4.3  | 4.6  | V         |
| Boost Regulator BREG                  | $V_{BREG}$        |  |      | 4.3  |      | V         |
| $V_{CCINT}$ UVLO Threshold            | $V_{UVLO}$        | $V_{CCINT}$ rising   | 3.1  | 3.4  | 3.7  | V         |
|                                       |                   | $V_{CCINT}$ falling  | 3.0  | 3.3  | 3.6  |           |

### Electrical Characteristics (continued)

( $V_{BAT} = 8.3V$ ,  $T_A = -40^{\circ}C$  to  $+85^{\circ}C$ , all registers in their default state, unless otherwise noted. Typical values are at  $V_{CHGIN} = 5.0V$ ,  $V_{BAT} = 7.4V$ ,  $T_A = +25^{\circ}C$ .) (Note 1)

| PARAMETER                             | SYMBOL            | CONDITIONS   | MIN  | TYP  | MAX  | UNITS       |
|---------------------------------------|-------------------|--|------|------|------|-------------|
| $V_{CCINT}$ UVLO Threshold Hysteresis | $V_{UVLO\_HYS}$   | Hysteresis   |      | 100  |      | mV          |
| SFOUT LDO Voltage                     | $V_{SFOUT}$       | SfOutLvl = 1, $V_{CHGIN} = 6V$ ,<br>$I_{SFOUT} = 0$    | 3.15 | 3.3  | 3.45 | V           |
|                                       |                   | SfOutLvl = 1, $V_{CHGIN} = 6V$ ,<br>$I_{SFOUT} = 15mA$ |      | 2.95 |      |             |
|                                       |                   | SfOutLvl = 0, $V_{CHGIN} = 6V$ ,<br>$I_{SFOUT} = 0$    | 5.0  | 5.25 | 5.5  |             |
|                                       |                   | SfOutLvl = 0, $V_{CHGIN} = 6V$ ,<br>$I_{SFOUT} = 15mA$ |      | 4.9  |      |             |
| SFOUT Maximum Current                 | $I_{SFOUT\_MAX}$  |  | 15   |      |      | mA          |
| Current Reduce Temperature            | $T_{CHG\_LIM}$    |  |      | 120  |      | $^{\circ}C$ |
| Thermal Shutdown Temperature          | $T_{SHUTDOWN}$    |  |      | 150  |      | $^{\circ}C$ |
| Thermal Shutdown Hysteresis           | $T_{SHUTDOWN\_H}$ |  |      | 20   |      | $^{\circ}C$ |
| BYP UVLO Threshold                    | $V_{BYPUVLO}$     | BYPUVLO[2:0] = 000, $V_{BYP}$ falling                  |      | 3.8  |      | V           |
|                                       |                   | BYPUVLO[2:0] = 001, $V_{BYP}$ falling                  |      | 3.9  |      |             |
|                                       |                   | BYPUVLO[2:0] = 010, $V_{BYP}$ falling                  |      | 4.0  |      |             |
|                                       |                   | BYPUVLO[2:0] = 011, $V_{BYP}$ falling                  |      | 4.1  |      |             |
|                                       |                   | BYPUVLO[2:0] = 100, $V_{BYP}$ falling                  |      | 4.2  |      |             |
|                                       |                   | BYPUVLO[2:0] = 101, $V_{BYP}$ falling                  |      | 4.3  |      |             |
|                                       |                   | BYPUVLO[2:0] = 110, $V_{BYP}$ falling                  |      | 4.4  |      |             |
|                                       |                   | BYPUVLO[2:0] = 111, $V_{BYP}$ falling                  |      | 4.5  |      |             |
| BYP UVLO Threshold Hysteresis         | $V_{BYPUVLO\_H}$  |  |      | 25   |      | mV          |
| SYS UVLO (SYSOK) Threshold            | $V_{SYSUVLO}$     | VPChg[2:0] = 000, $V_{SYS}$ rising                     |      | 5.9  |      | V           |
|                                       |                   | VPChg[2:0] = 001, $V_{SYS}$ rising                     |      | 6.0  |      |             |
|                                       |                   | VPChg[2:0] = 010, $V_{SYS}$ rising                     |      | 6.1  |      |             |
|                                       |                   | VPChg[2:0] = 011, $V_{SYS}$ rising                     |      | 6.2  |      |             |
|                                       |                   | VPChg[2:0] = 100, $V_{SYS}$ rising                     |      | 6.3  |      |             |
|                                       |                   | VPChg[2:0] = 101, $V_{SYS}$ rising                     |      | 6.4  |      |             |
|                                       |                   | VPChg[2:0] = 110, $V_{SYS}$ rising                     |      | 6.5  |      |             |
|                                       |                   | VPChg[2:0] = 111, $V_{SYS}$ rising                     |      | 6.6  |      |             |
| SYS UVLO Threshold Hysteresis         | $V_{SYSUVLO\_H}$  |  |      | 500  |      | mV          |

**Electrical Characteristics (continued)**

(V<sub>BAT</sub> = 8.3V, T<sub>A</sub> = -40°C to +85°C, all registers in their default state, unless otherwise noted. Typical values are at V<sub>CHGIN</sub> = 5.0V, V<sub>BAT</sub> = 7.4V, T<sub>A</sub> = +25°C.) (Note 1)

| PARAMETER                  | SYMBOL                  | CONDITIONS  | MIN   | TYP  | MAX | UNITS |
|----------------------------|-------------------------|---|-------|------|-----|-------|
| <b>BYP-SYS BOOST PATH</b>  |                         |   |       |      |     |       |
| Switching Frequency        | f <sub>BST_SW</sub>     |   |       | 0.8  |     | MHz   |
| Maximum Input Current      | I <sub>BST_MAX</sub>    | L = 2.2μH   | 3     |      |     | A     |
| Input Peak Current Limit   | I <sub>BST_LIM_PK</sub> |   |       | 4.5  |     | A     |
| Forced Input Current Limit | I <sub>LIM_F</sub>      | CurLim1Frc = 1 ,<br>CurLim1Set[4:0] =   | 0000  | 100  |     | mA    |
|                            |                         |   | 00001 | 200  |     |       |
|                            |                         |   | 00010 | 300  |     |       |
|                            |                         |   | 00011 | 400  |     |       |
|                            |                         |   | 00100 | 405  | 495 |       |
|                            |                         |   | 00101 | 600  |     |       |
|                            |                         |   | 00110 | 700  |     |       |
|                            |                         |   | 00111 | 800  |     |       |
|                            |                         |   | 01000 | 900  |     |       |
|                            |                         |   | 01001 | 1000 |     |       |
|                            |                         |   | 01010 | 1100 |     |       |
|                            |                         |   | 01011 | 1200 |     |       |
|                            |                         |   | 01100 | 1300 |     |       |
|                            |                         |   | 01101 | 1400 |     |       |
|                            |                         |   | 01110 | 1500 |     |       |
|                            |                         |   | 01111 | 1600 |     |       |
|                            |                         |   | 10000 | 1700 |     |       |
|                            |                         |   | 10001 | 1800 |     |       |
|                            |                         |   | 10010 | 1900 |     |       |
|                            |                         |   | 10011 | 2000 |     |       |
| 10100                      | 2100                    |   |       |      |     |       |
| 10101                      | 2200                    |   |       |      |     |       |
| 10110                      | 2300                    |   |       |      |     |       |
| 10111                      | 2400                    |   |       |      |     |       |
| 11000                      | 2500                    |   |       |      |     |       |
| 11001                      | 2600                    |   |       |      |     |       |
| 11010                      | 2700                    |   |       |      |     |       |
| 11011                      | 2800                    |   |       |      |     |       |
| 11100                      | 2900                    |   |       |      |     |       |
| 11101                      | 3000                    |   |       |      |     |       |
| 11110                      | 3100                    |   |       |      |     |       |
| 11111                      | 3200                    |   |       |      |     |       |
| Efficiency                 | EFF <sub>BST</sub>      | I <sub>SYS</sub> = 1000mA, V <sub>BAT</sub> = 7.4V,<br>L1 = Bourns SRP4012TA-2R2M |       | 91.6 |     | %     |

## Electrical Characteristics (continued)

( $V_{BAT} = 8.3V$ ,  $T_A = -40^{\circ}C$  to  $+85^{\circ}C$ , all registers in their default state, unless otherwise noted. Typical values are at  $V_{CHGIN} = 5.0V$ ,  $V_{BAT} = 7.4V$ ,  $T_A = +25^{\circ}C$ .) (Note 1)

| PARAMETER                                | SYMBOL              | CONDITIONS  | MIN  | TYP                  | MAX  | UNITS        |
|--|---------------------|---|------|----------------------|------|--------------|
| SYS Regulation Voltage                   | $V_{SYS\_REG}$      | Charger disabled  |      | $V_{BAT} + 0.4$      |      | V            |
|  |                     | Charger in precharge, $V_{BAT} = 5V$  |      | $V_{PCHG} + 0.4$     |      | V            |
| SYS Regulation Voltage Limit             | $V_{SYS\_LIM}$      | See Battery Charger State Diagram   |      | $V_{SYS\_REG} - 0.2$ |      | V            |
| <b>BYP-SYS BUCK PATH</b>                 |                     |   |      |                      |      |              |
| Switching Frequency                      | $f_{BK\_SW}$        |   |      | 0.8                  |      | MHz          |
| Maximum Output Current                   | $I_{BK\_MAX}$       | $L = 2.2\mu H$  | 500  |                      |      | mA           |
| Short-Circuit Peak Current Limit         | $I_{BK\_LIM}$       |   |      | 1.3                  |      | A            |
| Efficiency                               | $EFF_{BK}$          | $I_{CHGIN} = 500mA$ , $V_{BAT} = 7.4V$ ,<br>$L1 = \text{Bourns SRP4012TA-2R2M}$ |      | 94                   |      | %            |
| Output Voltage Range                     | $V_{BK\_OUT\_RNG}$  |   | 4    |                      | 5.5  | V            |
| Output Accuracy                          | $V_{BK\_OUT\_ACC}$  |   | -1.5 |                      | +1.5 | %            |
| <b>SYS-BAT CHARGER/SWITCH CONTROLLER</b> |                     |   |      |                      |      |              |
| BAT-to-SYS Regulation Voltage            | $V_{BAT\_SYS\_ON}$  | MAX14748  |      | -20                  |      | mV           |
|  |                     | MAX14748B   |      | -40                  |      |              |
| BAT-to-SYS Switch Fast Turn-On Threshold | $V_{BAT\_SYS\_OFF}$ | $V_{SYS}$ falling   |      | -100                 |      | mV           |
| BAT-to-SYS Switch On-Resistance          | $R_{BAT\_SYS}$      | $I_{BAT} = 1A$  |      | 13                   |      | m $\Omega$   |
| Charger Current Soft-Start Time          | $t_{CHG\_SOFT}$     |   |      | 1                    |      | ms           |
| <b>PRECHARGE</b>                         |                     |   |      |                      |      |              |
| Precharge Current                        | $I_{PCHG}$          | $IPChg[1:0] = 00$   |      | 5                    |      | % $I_{FCHG}$ |
|  |                     | $IPChg[1:0] = 01$   |      | 10                   |      |              |
|  |                     | $IPChg[1:0] = 10$   |      | 20                   |      |              |
|  |                     | $IPChg[1:0] = 11$ , $R_{SET} = 20k\Omega$                                       | 27   | 30                   | 33   |              |
| Prequalification Threshold               | $V_{PCHG}$          | $VPChg[2:0] = 000$  |      | 5.7                  |      | V            |
|  |                     | $VPChg[2:0] = 001$  |      | 5.8                  |      |              |
|  |                     | $VPChg[2:0] = 010$  |      | 5.9                  |      |              |
|  |                     | $VPChg[2:0] = 011$  |      | 6.0                  |      |              |
|  |                     | $VPChg[2:0] = 100$  |      | 6.1                  |      |              |
|  |                     | $VPChg[2:0] = 101$  |      | 6.2                  |      |              |
|  |                     | $VPChg[2:0] = 110$  |      | 6.3                  |      |              |
|  |                     | $VPChg[2:0] = 111$  |      | 6.4                  |      |              |
| Prequalification Threshold Hysteresis    | $V_{PCHG\_H}$       |   |      | 100                  |      | mV           |

### Electrical Characteristics (continued)

( $V_{BAT} = 8.3V$ ,  $T_A = -40^{\circ}C$  to  $+85^{\circ}C$ , all registers in their default state, unless otherwise noted. Typical values are at  $V_{CHGIN} = 5.0V$ ,  $V_{BAT} = 7.4V$ ,  $T_A = +25^{\circ}C$ .) (Note 1)

| PARAMETER                                    | SYMBOL          | CONDITIONS  | MIN   | TYP   | MAX   | UNITS        |
|--|-----------------|---|-------|-------|-------|--------------|
| <b>FAST CHARGE</b>                           |                 |   |       |       |       |              |
| SET Current Gain Factor                      | $K_{SET}$       |   |       | 10000 |       | A/A          |
| SET Regulation Voltage                       | $V_{SET}$       |   |       | 1     |       | V            |
| Fast-Charge Current                          | $I_{FCHG}$      | $R_{SET} = 20k\Omega$                                       | 0.43  | 0.5   | 0.57  | A            |
|  |                 | $R_{SET} = 20k\Omega$ , $T = 25^{\circ}C$                   | 0.475 | 0.5   | 0.525 |              |
|  |                 | $R_{SET} = 10k\Omega$                                       |       | 1     |       |              |
|  |                 | $R_{SET} = 4k\Omega$  |       | 2.5   |       |              |
| Fast-Charge Current Scaling                  | $I_{FCHG\_T}$   | $T\_T\_IFChg[2:0] = 000$                                    |       | 20    |       | % $I_{FCHG}$ |
|  |                 | $T\_T\_IFChg[2:0] = 001$                                    |       | 30    |       |              |
|  |                 | $T\_T\_IFChg[2:0] = 002$                                    |       | 40    |       |              |
|  |                 | $T\_T\_IFChg[2:0] = 003$                                    |       | 50    |       |              |
|  |                 | $T\_T\_IFChg[2:0] = 004$                                    |       | 60    |       |              |
|  |                 | $T\_T\_IFChg[2:0] = 005$                                    |       | 70    |       |              |
|  |                 | $T\_T\_IFChg[2:0] = 006$                                    |       | 80    |       |              |
|  |                 | $T\_T\_IFChg[2:0] = 007$                                    |       | 100   |       |              |
| 1/2 Fast-Charge Current Comparator Threshold | $I_{FC\_HALF}$  |   |       | 50    |       | % $I_{FCHG}$ |
| 1/5 Fast-Charge Current Comparator Threshold | $I_{FC\_FIFTH}$ |   |       | 20    |       | % $I_{FCHG}$ |
| <b>MAINTAIN CHARGE</b>                       |                 |   |       |       |       |              |
| Charge Done Qualification                    | $I_{CHG\_DONE}$ | $ChgDone[1:0] = 00$   |       | 5     |       | % $I_{FCHG}$ |
|  |                 | $ChgDone[1:0] = 01$   |       | 10    |       |              |
|  |                 | $ChgDone[1:0] = 10$ , $R_{SET} = 20k\Omega$                 | 18    | 20    | 22    |              |
| BAT Regulation Voltage                       | $V_{BATREG}$    | $BatReg[1:0] = 00$ , $T_A = +25^{\circ}C$                   | 8.258 | 8.3   | 8.342 | V            |
|  |                 | $BatReg[1:0] = 00$ , $T_A = -40^{\circ}C$ to $+85^{\circ}C$ | 8.217 | 8.3   | 8.383 |              |
|  |                 | $BatReg[1:0] = 01$  |       | 8.4   |       |              |
|  |                 | $BatReg[1:0] = 10$  |       | 8.5   |       |              |
|  |                 | $BatReg[1:0] = 11$  |       | 8.6   |       |              |
| BAT Recharge Threshold                       | $V_{BATRECHG}$  | $BatReChg[1:0] = 00$  |       | 200   |       | mV           |
|  |                 | $BatReChg[1:0] = 01$  |       | 300   |       |              |
|  |                 | $BatReChg[1:0] = 10$  |       | 400   |       |              |
|  |                 | $BatReChg[1:0] = 11$  |       | 500   |       |              |

## Electrical Characteristics (continued)

( $V_{BAT} = 8.3V$ ,  $T_A = -40^{\circ}C$  to  $+85^{\circ}C$ , all registers in their default state, unless otherwise noted. Typical values are at  $V_{CHGIN} = 5.0V$ ,  $V_{BAT} = 7.4V$ ,  $T_A = +25^{\circ}C$ .) (Note 1)

| PARAMETER                                   | SYMBOL            | CONDITIONS   | MIN  | TYP  | MAX  | UNITS       |
|---|-------------------|--|------|------|------|-------------|
| <b>CHARGE TIMER</b>                         |                   |  |      |      |      |             |
| Maximum Prequalification Time               | $t_{PCHG}$        | PChgTmr[1:0] = 00  |      | 30   |      | min         |
|   |                   | PChgTmr[1:0] = 01  |      | 60   |      |             |
|   |                   | PChgTmr[1:0] = 10  |      | 120  |      |             |
|   |                   | PChgTmr[1:0] = 11  |      | 240  |      |             |
| Maximum Fast-Charge Time                    | $t_{FCHG}$        | FChgTmr[1:0] = 00  |      | 75   |      | Min         |
|   |                   | FChgTmr[1:0] = 01  |      | 150  |      |             |
|   |                   | FChgTmr[1:0] = 10  |      | 300  |      |             |
|   |                   | FChgTmr[1:0] = 11  |      | 600  |      |             |
| Maintain Charge Time                        | $t_{TOCHG}$       | MtChgTmr[1:0] = 00   |      | 0    |      | Min         |
|   |                   | MtChgTmr[1:0] = 01   |      | 15   |      |             |
|   |                   | MtChgTmr[1:0] = 10   |      | 30   |      |             |
|   |                   | MtChgTmr[1:0] = 11   |      | 60   |      |             |
| Timer Accuracy                              | $t_{ACC}$         |  | -10  |      | +10  | %           |
| Timer Extend Threshold                      | $P_{TIMERX}$      | If charge current is reduced due to $I_{LIM}$ or $T_{DIE}$ , this is the percentage of charge current below which timer clock operates at half speed |      | 50   |      | %           |
| Timer Suspend Threshold                     | $P_{TIMERSUS}$    | If charge current is reduced due to $I_{LIM}$ or $T_{DIE}$ , this is the percentage of charge current below which timer clock pauses                 |      | 20   |      | %           |
| <b>THERMISTOR MONITOR AND NTC DETECTION</b> |                   |  |      |      |      |             |
| THM Hot Threshold                           | T4                | $V_{THM}$ falling, WarmCoolSel = 0   | 21.3 | 23.3 | 25.3 | % $V_{TPU}$ |
|   |                   | $V_{THM}$ falling, WarmCoolSel = 1   | 30.9 | 32.9 | 34.9 |             |
| THM Warm Threshold                          | T3                | $V_{THM}$ falling, WarmCoolSel = 0   | 30.9 | 32.9 | 34.9 | % $V_{TPU}$ |
|   |                   | $V_{THM}$ falling, WarmCoolSel = 1   | 46.5 | 50   | 53.5 |             |
| THM Cool Threshold                          | T2                | $V_{THM}$ rising, WarmCoolSel = 0 or 1   | 62.5 | 64.5 | 66.5 | % $V_{TPU}$ |
| THM Cold Threshold                          | T1                | $V_{THM}$ rising, WarmCoolSel = 0 or 1   | 71.9 | 73.9 | 75.9 | % $V_{TPU}$ |
| THM Disable Threshold                       | $V_{THM\_DIS}$    | $V_{THM}$ rising   | 91.0 | 93.0 | 95.0 | % $V_{TPU}$ |
| THM Threshold Hysteresis                    | $V_{THM\_DIS\_H}$ |  |      | 60   |      | mV          |
| JEITA BAT Voltage Reduction                 | $V_{BAT\_JEITA}$  |  |      | 300  |      | mV          |
| THM Input Leakage                           | $I_{THM\_LK}$     |  | -1   |      | +1   | $\mu A$     |
| THM Detection Time                          | $t_{THM\_DET}$    |  |      | 0.4  |      | ms          |



## Electrical Characteristics (continued)

( $V_{BAT} = 8.3V$ ,  $T_A = -40^{\circ}C$  to  $+85^{\circ}C$ , all registers in their default state, unless otherwise noted. Typical values are at  $V_{CHGIN} = 5.0V$ ,  $V_{BAT} = 7.4V$ ,  $T_A = +25^{\circ}C$ .) (Note 1)

| PARAMETER   | SYMBOL                     | CONDITIONS                   | MIN  | TYP  | MAX | UNITS     |
|---|----------------------------|------------------------------|------|------|-----|-----------|
| <b>DIGITAL I/O (SDA, SCL, <math>\overline{FLTIN}</math>, <math>\overline{INT}</math>, SYSOK, FSUS, LED, CDIR)</b> |                            |                              |      |      |     |           |
| Leakage Current   | $I_{IO\_LK}$               |                              | -1   |      | +1  | $\mu A$   |
| Logic Input High-Voltage  | $V_{IO\_IH}$               |                              | 1.4  |      |     | V         |
| Logic Input Low-Voltage   | $V_{IO\_IL}$               |                              |      |      | 0.5 | V         |
| Logic Output Low-Voltage  | $V_{IO\_OL}$               | $I_{OL} = 4mA$               |      |      | 0.4 | V         |
| FSUS Input Pulldown Resistance  | $R_{FSUS\_PD}$             |                              |      | 470  |     | $k\Omega$ |
| SDA, SCL Bus Low-Detection Current  | $I_{PD}$                   | $V_{SDA} = V_{SCL} = 0.4V$   |      | 0.2  | 0.4 | $\mu A$   |
| SCL Clock Frequency   | $f_{SCL}$                  | Note 2                       | 0    |      | 400 | kHz       |
| Bus Free Time Between a STOP and START Condition  | $t_{BUF}$                  |                              | 1.3  |      |     | $\mu s$   |
| START Condition (Repeated) Hold Time  | $t_{HD\_SDA}$              | Note 2                       | 0.6  |      |     | $\mu s$   |
| Low Period of SCL Clock   | $t_{LOW}$                  |                              | 1.3  |      |     | $\mu s$   |
| High Period of SCL Clock  | $t_{HIGH}$                 |                              | 0.6  |      |     | $\mu s$   |
| Setup Time for a Repeated START Condition   | $t_{SU\_STA}$              |                              | 0.6  |      |     | $\mu s$   |
| Data Hold Time  | $t_{HD\_DAT}$              | Note 3                       | 0    |      | 0.9 | $\mu s$   |
| Data Setup Time   | $t_{SU\_DAT}$              | Note 3                       | 100  |      |     | ns        |
| Setup Time for STOP Condition   | $t_{SU\_STO}$              |                              | 0.6  |      |     | $\mu s$   |
| Spike Pulse Widths Suppressed by Input Filter   | $t_{SP}$                   | Note 4                       |      | 50   |     | ns        |
| <b>BC1.2 DETECTION</b>  |                            |                              |      |      |     |           |
| $V_{DP\_SRC}$ Voltage   | $V_{DP\_SRC}/V_{SRC06}$    | $I_{LOAD} = 0$ to $200\mu A$ | 0.5  | 0.6  | 0.7 | V         |
| $V_{DM\_SRC}$ Voltage   | $V_{DM\_SRC}/V_{SRC06}$    | $I_{LOAD} = 0$ to $200\mu A$ | 0.5  | 0.6  | 0.7 | V         |
| $V_{D33}$ Voltage   | $V_{SRC33}$                | $I_{LOAD} = 0$ to $365\mu A$ | 2.6  |      | 3.4 | V         |
| $V_{DAT\_REF}$ Voltage  | $V_{DAT\_REF}$             |                              | 0.25 | 0.32 | 0.4 | V         |
| $V_{LGC}$ Voltage   | $V_{LGC}$                  |                              | 1.5  | 1.7  | 1.9 | V         |
| $I_{DM\_SINK}$ Current  | $I_{DM\_SINK}/I_{DATSINK}$ | 0.15V to 3.6V                | 55   | 80   | 105 | $\mu A$   |
| $I_{DP\_SRC}$ Current   | $I_{DP\_SRC}/I_{DCD}$      | 0V to 2.5V                   | 7    | 10   | 13  | $\mu A$   |

### Electrical Characteristics (continued)

( $V_{BAT} = 8.3V$ ,  $T_A = -40^{\circ}C$  to  $+85^{\circ}C$ , all registers in their default state, unless otherwise noted. Typical values are at  $V_{CHGIN} = 5.0V$ ,  $V_{BAT} = 7.4V$ ,  $T_A = +25^{\circ}C$ .) (Note 1)

| PARAMETER                                 | SYMBOL                  | CONDITIONS   | MIN   | TYP | MAX   | UNITS      |
|---|-------------------------|--|-------|-----|-------|------------|
| $R_{DM\_DWN}$ Resistor                    | $R_{DM\_DWN}/R_{DWN15}$ |  | 12    | 20  | 24    | k $\Omega$ |
| $I_{WEAK}$ Current                        | $I_{WEAK}$              |  | 0.01  | 0.1 | 0.5   | $\mu A$    |
| $V_{BUS31}$ Threshold                     | $V_{BUS31}$             | DP and DN pins. Threshold in percent of $V_{BUS}$ voltage<br>$4V < V_{BUS} < 5.5V$ | 26    | 31  | 36    | %          |
| $V_{BUS47}$ Threshold                     | $V_{BUS47}$             | DP and DN pins. Threshold in percent of $V_{BUS}$ voltage<br>$4V < V_{BUS} < 5.5V$ | 43.3  | 47  | 51.7  | %          |
| $V_{BUS64}$ Threshold                     | $V_{BUS64}$             | DP and DN pins. Threshold in percent of $V_{BUS}$ voltage<br>$4V < V_{BUS} < 5.5V$ | 57    | 64  | 71    | %          |
| Charger Detection Debounce                | $t_{CDDEB}$             |  | 45    | 50  | 55    | ms         |
| Primary-to-Secondary Timer                | $t_{PDSWAIT}$           |  | 27    | 35  | 39    | ms         |
| Proprietary Charger Debounce              | $t_{PRDEB}$             |  | 5     | 7.5 | 10    | ms         |
| Data Contact Detect Timeout               | $t_{DCDTMO}$            | DCD2s = 0  | 700   | 800 | 900   | ms         |
|   |                         | DCD2s = 1  | 1.8   | 2.0 | 2.2   |            |
| DP/DN Overvoltage Debounce                | $t_{OVDXDEB}$           |  | 90    | 100 | 110   | $\mu s$    |
| OVDX Comparator                           | $OVDX_{THRESHOLD}$      | Rising   | 0     |     | 0.15  | V          |
|   |                         | Falling  | -0.04 |     | +0.08 |            |
| CDP/CDN Pulldown Resistor                 | $R_{CDP/CDN\_PD}$       |  | 3     | 6   | 12    | m $\Omega$ |
| <b>TYPE-C DETECTION</b>                   |                         |  |       |     |       |            |
| $V_{CONN}$ Switch Voltage Drop            | $V_{CONN\_REQ}$         | $V_{CONN} = 5.5V$ , $I_{CC\_LOAD} = 20mA$  | 5.5   |     | 5.6   | V          |
| $V_{CONN}$ Bulk Capacitance               | $C_{VCONN}$             |  | 10    |     | 220   | $\mu F$    |
| CC Pin Operational Voltage Range          | $V_{CONN\_RNG}$         |  |       |     | 5.5   | V          |
| CC Pin Voltage in DFP 3.0A Mode           | $V_{CC\_PIN30}$         |  | 3.1   |     |       | V          |
| CC Pin Voltage in DFP 1.5A Mode           | $V_{CC\_PIN15}$         |  | 1.85  |     |       | V          |
| CC Pin Low-Power Mode Pulldown Resistance | $R_{LPPD\_CC\_}$        |  |       | 170 |       | k $\Omega$ |

### Electrical Characteristics (continued)

( $V_{BAT} = 8.3V$ ,  $T_A = -40^{\circ}C$  to  $+85^{\circ}C$ , all registers in their default state, unless otherwise noted. Typical values are at  $V_{CHGIN} = 5.0V$ ,  $V_{BAT} = 7.4V$ ,  $T_A = +25^{\circ}C$ .) (Note 1)

| PARAMETER                                    | SYMBOL               | CONDITIONS  | MIN   | TYP   | MAX   | UNITS      |
|--|----------------------|---|-------|-------|-------|------------|
| CC Pin Low-Power Mode Voltage Threshold      | $V_{LP\_CC\_}$       | Rising  |       | 0.7   |       | V          |
| CC Pin Clamp Requirements                    | $V_{CC\_PIN\_CLAMP}$ | $60\mu A \leq I_{CC\_} \leq 600\mu A$   |       | 1.1   | 1.32  | V          |
| CC UFP Pulldown Resistance                   | $R_{DUFP\_CC\_}$     |   | 4.59  | 5.1   | 5.61  | k $\Omega$ |
| CC DFP 0.5A Current Source                   | $I_{DFP0.5\_CC\_}$   |   | 72    | 80    | 88    | $\mu A$    |
| CC DFP 1.5A Current Source                   | $I_{DFP1.5\_CC\_}$   |   | 165.6 | 180   | 194.4 | $\mu A$    |
| CC DFP 3.0A Current Source                   | $I_{DFP3.0\_CC\_}$   |   | 303.6 | 330   | 356.4 | $\mu A$    |
| CC $R_A$ and $R_D$ Threshold                 | $V_{RA\_RD0.5}$      | Rising  | 0.16  | 0.2   | 0.25  | V          |
|  |                      | Falling   | 0.15  |       |       |            |
| CC UFP 0.5A $R_D$ Threshold                  | $V_{UFP\_RD0.5}$     | Rising  | 0.62  | 0.66  | 0.7   | V          |
|  |                      | Falling   | 0.61  |       |       |            |
| CC UFP 1.5A $R_D$ Threshold                  | $V_{UFP\_RD1.5}$     | Rising  | 1.17  | 1.23  | 1.31  | V          |
|  |                      | Falling   | 1.16  |       |       |            |
| CC $V_{CONN}$ Detect Threshold               | $V_{VCONN\_DET}$     | Rising  | 2.11  | 2.25  | 2.4   | V          |
|  |                      | Falling   | 2.1   |       |       |            |
| CC DFP $V_{OPEN}$ Detect Threshold           | $V_{DFP\_VOPEN}$     | Rising  | 1.51  | 1.575 | 1.65  | V          |
|  |                      | Falling   | 1.5   |       |       |            |
| CC DFP $V_{OPEN}$ with 3.0A Detect Threshold | $V_{DFP\_VOPEN3A}$   | Rising  | 2.46  | 2.6   | 2.75  | V          |
|  |                      | Falling   | 2.45  |       |       | V          |
| $V_{BUS}$ Valid                              | $V_{BDET}$           | Rising  | 3.8   | 4.12  | 4.4   | V          |
| $V_{BUS}$ Valid Hysteresis                   | $V_{BDET\_H}$        | Falling hysteresis  |       | 0.7   |       | V          |
| $V_{BUS}$ Discharge Value                    | $V_{SAFE0V}$         | Falling. Voltage level where a connected UFP will find $V_{BUS}$ removed.                 | 0.6   | 0.7   | 0.84  | V          |
|  |                      | Rising hysteresis   |       | 100   |       | mV         |
| CC Pin Power-Up Time                         | $t_{CLAMPSWAP}$      | The maximum time allowed from removal of voltage clamp to attachment of the 5.1k resistor |       |       | 15    | ms         |
| Type-C CC Pin Detection Debounce             | $t_{CCDEB}$          |   | 100   |       | 200   | ms         |
| Type-C Debounce                              | $t_{PDDEB}$          |   | 10    |       | 20    | ms         |

## Electrical Characteristics (continued)

( $V_{BAT} = 8.3V$ ,  $T_A = -40^{\circ}C$  to  $+85^{\circ}C$ , all registers in their default state, unless otherwise noted. Typical values are at  $V_{CHGIN} = 5.0V$ ,  $V_{BAT} = 7.4V$ ,  $T_A = +25^{\circ}C$ .) (Note 1)

| PARAMETER                   | SYMBOL              | CONDITIONS  | MIN                 | TYP | MAX | UNITS |
|-----------------------------|---------------------|---|---------------------|-----|-----|-------|
| Type-C Quick Debounce       | $t_{QDEB}$          |   | 0.9                 | 1   | 1.9 | ms    |
| $V_{BUS}$ Debounce          | $t_{VBDEB}$         |   | 9                   | 10  | 11  | ms    |
| $V_{SAFE0V}$ Debounce       | $t_{VSAFE0VDEB}$    |   | 9                   | 10  | 11  | ms    |
| Type-C Error Recovery Delay | $t_{ERRORRECOVERY}$ |   | 25                  |     |     | ms    |
| Type-C DRP Toggle Time      | $t_{DRP}$           |   | 50                  |     | 100 | ms    |
| Duty Cycle of DRP Swap      | $D_{DRP}$           | Duty cycle of UFP to DFP role swap  | 30                  |     | 70  | %     |
| DRP Transition Time         | $t_{DRPTRAN}$       | Time a role swap from DFP to UFP or reverse is completed                                      |                     |     | 1   | ms    |
| DRP Lock Time               | $t_{DRPLOCK}$       | DRP Lock wait time before transition to unattached state                                      | 100                 |     | 150 | ms    |
| $V_{CONN}$ Enable Time      | $t_{VCONNON}$       | Time from when $V_{BUS}$ is supplied in DFP mode in state Attach.DFP. DRPWait                 |                     |     | 10  | ms    |
| $V_{CONN}$ Disable Time     | $t_{VCONNOFF}$      | Time from UFP detached or as directed by I <sup>2</sup> C command until $V_{CONN}$ is removed |                     |     | 35  | ms    |
| CC Pin Current Change Time  | $t_{SINKADJ}$       | Time from CC pin changes state in UFP mode until current drawn from DFP reaches new value     |                     |     | 60  | ms    |
| $V_{BUS}$ On-Time           | $t_{VBUSON}$        | Time from UFP is attached until $V_{BUS}$ On  |                     |     | 275 | ms    |
| $V_{BUS}$ Off-Time          | $t_{VBUSOFF}$       | Time from UFP is detached until $V_{BUS}$ reaches $V_{SAFE0V}$                                |                     |     | 650 | ms    |
| BVCEN Output Low-Voltage    | $V_{BVCEN\_OL}$     | $I_{SINK} = 1mA$  |                     |     | 0.4 | V     |
| BVCEN Output High-Voltage   | $V_{BVCEN\_OH}$     | $I_{SOURCE} = 1mA$  | $V_{CCINT}$<br>-0.4 |     |     | V     |

**Note 1:** All devices are 100% production tested at  $T_A = +25^{\circ}C$ . Limits over the operating temperature range are guaranteed by design and characterization.

**Note 2:**  $f_{SCL}$  must meet the minimum clock low time plus the rise/fall times.

**Note 3:** The maximum  $t_{HD:DAT}$  has to be met only if the device does not stretch the low period ( $t_{LOW}$ ) of the SCL signal.

**Note 4:** Filters on SDA and SCL suppress noise spikes at the input buffers and delay the sampling instant.

### Typical Operating Characteristics

( $V_{BAT} = 8.5V$ ,  $T_A = -20^{\circ}C$  to  $+70^{\circ}C$ , all registers in their default state, unless otherwise noted. Typical values are at  $V_{CHGIN} = 5.0V$ ,  $V_{BAT} = 7.4V$ ,  $T_A = +25^{\circ}C$ .)

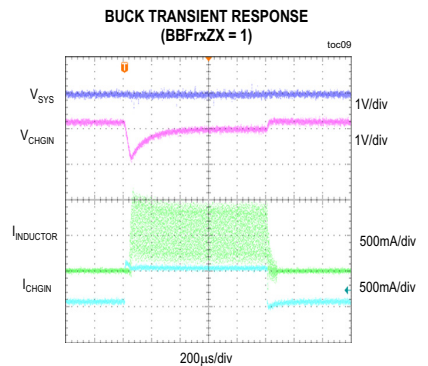
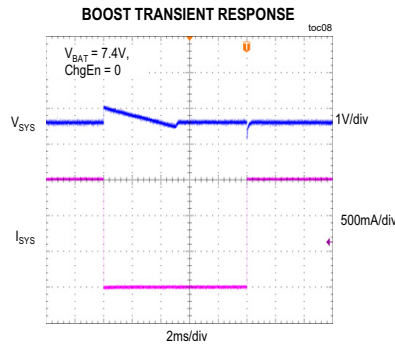
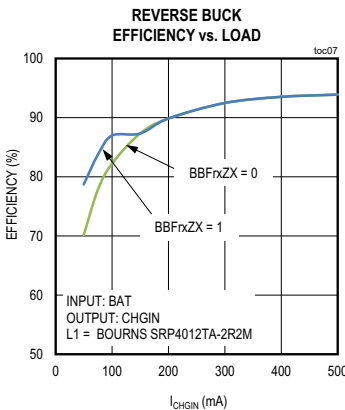
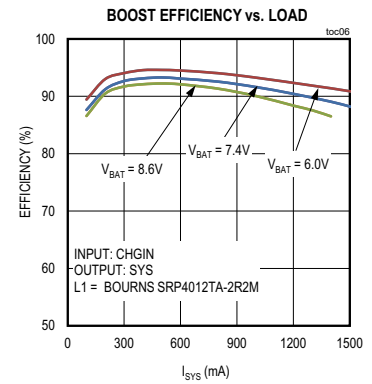
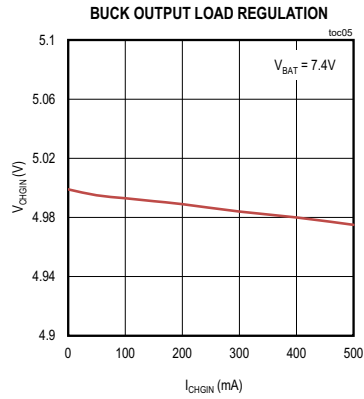
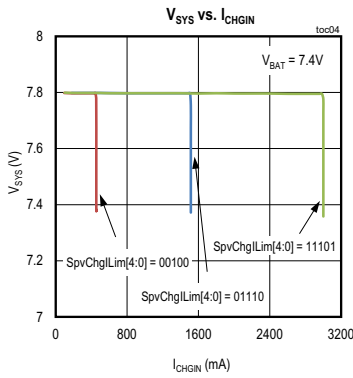
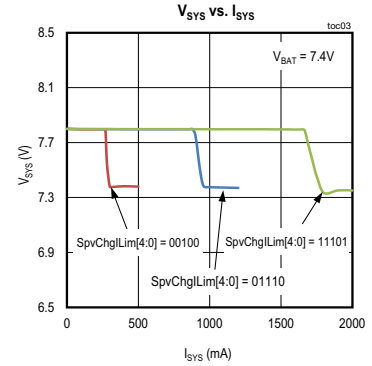
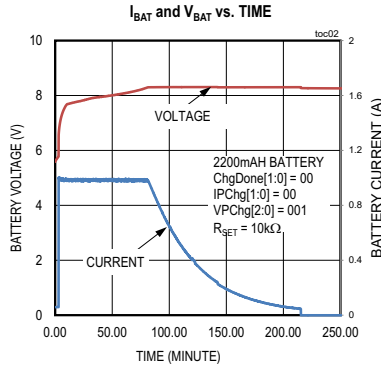
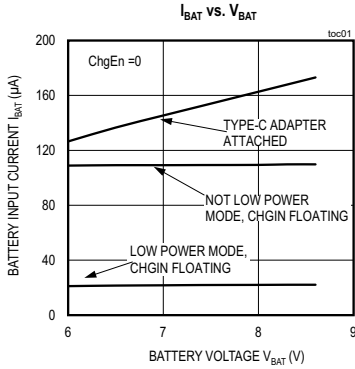

Typical Operating Characteristics (continued)

( $V_{BAT} = 8.5V$ ,  $T_A = -20^{\circ}C$  to  $+70^{\circ}C$ , all registers in their default state, unless otherwise noted. Typical values are at  $V_{CHGIN} = 5.0V$ ,  $V_{BAT} = 7.4V$ ,  $T_A = +25^{\circ}C$ .)

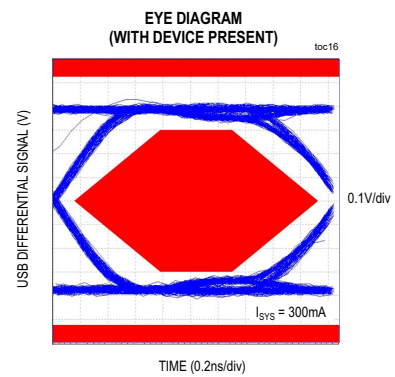
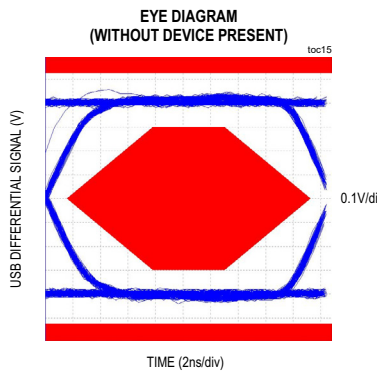
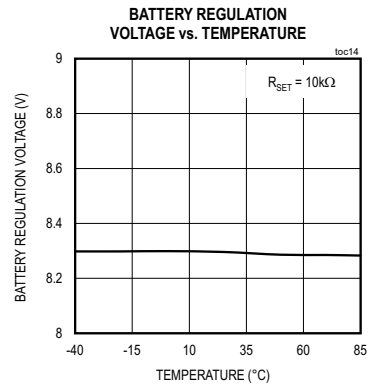
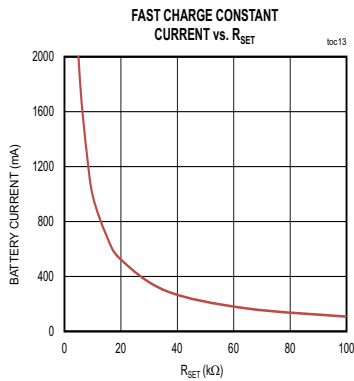
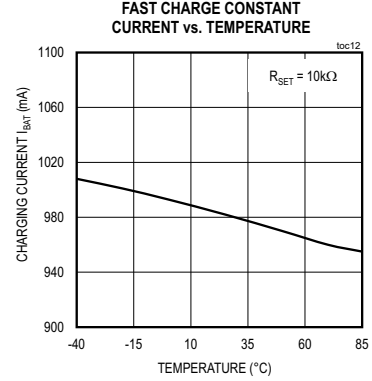
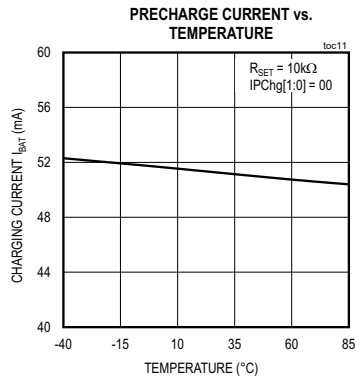
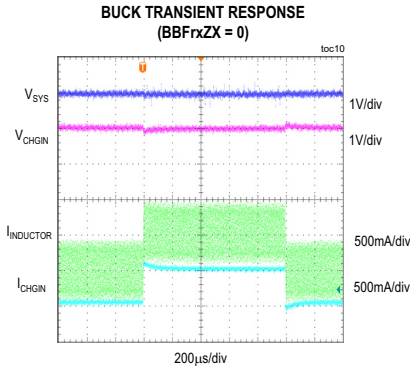

**Bump Configuration**

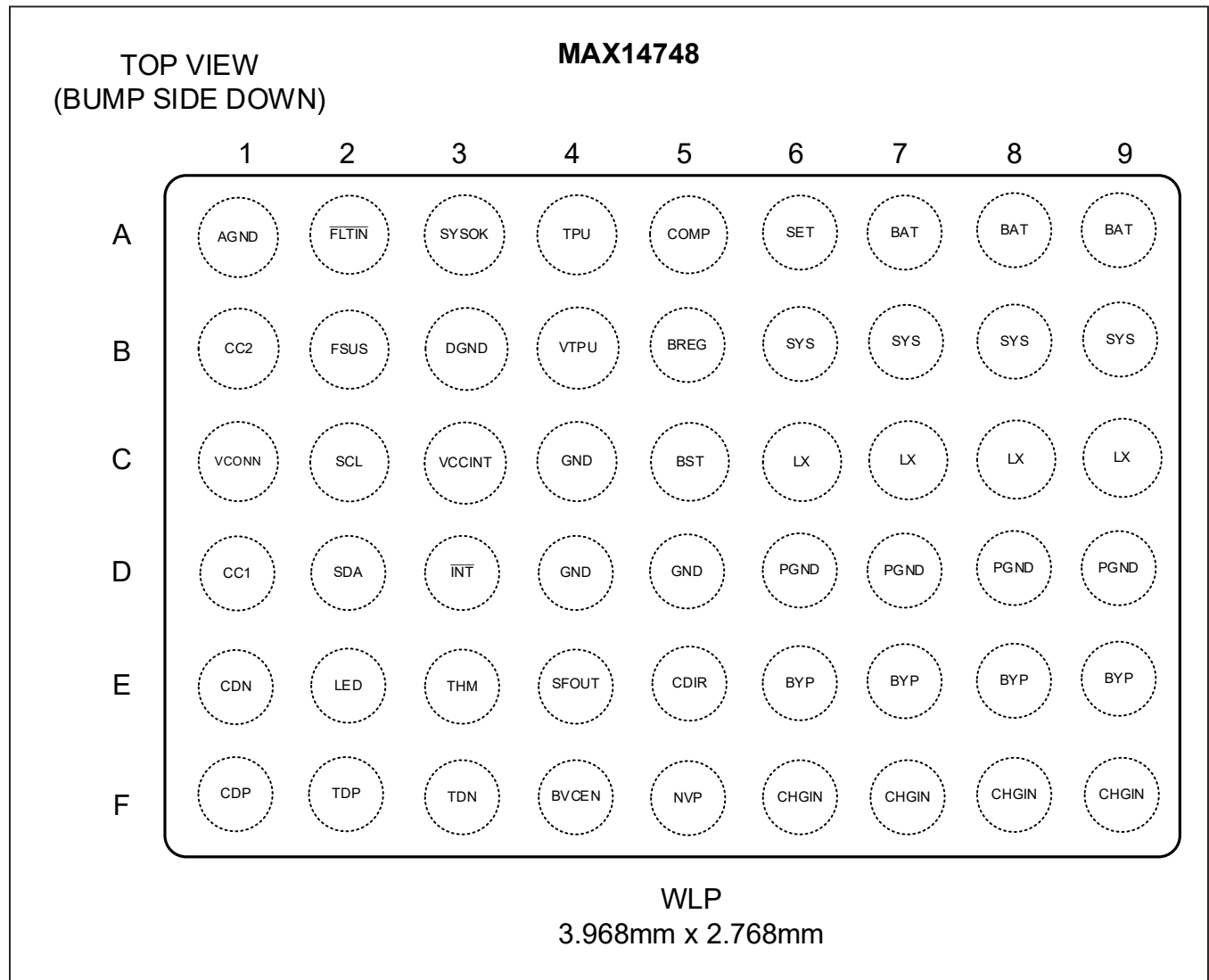

## Bump Descriptions

| BUMP           | NAME                      | FUNCTION   |
|----------------|---------------------------|--|
| A1             | AGND                      | Analog Ground.   |
| A2             | $\overline{\text{FLTIN}}$ | Charger Fault Input. Logic-low on this pin forces the charger into a fault state and generates an interrupt. See Register 0x35 description for more information. Connect to digital I/O supply if not used.  |
| A3             | SYSOK                     | Open-Drain Status Output of SYS Regulation. When $V_{\text{SYS}}$ is above the SYS UVLO threshold and Boost is active, this output is high-impedance. When $V_{\text{SYS}}$ is below the SYS UVLO threshold, this output is low. Leave unconnected if not used.  |
| A4             | TPU                       | High-Side of Internal Resistor for THM Detection. Connect a 10k resistor between this pin and THM.   |
| A5             | COMP                      | Buck/Boost Converter Compensation Connection. Connect a 3.9nF capacitor for internal Buck/Boost compensation   |
| A6             | SET                       | External Resistor Connection for Fast Charge Current Setting. Connect a resistor to this pin to set the fast charge current. Other charge currents are set as a proportion of fast charge current based on I <sup>2</sup> C register settings.   |
| A7–A9          | BAT                       | Battery Connection. Connect a 2s Li-ion+ battery from BAT to GND. Bypass to PGND with a parallel combination of a 0.1 $\mu$ F capacitor and an effective 10 $\mu$ F - 30 $\mu$ F capacitor. Keep the capacitors as close to BAT as possible and keep the stray inductance and resistance of the trace from BAT to the battery terminal as low as possible. |
| B1             | CC2                       | USB Type-C CC2. Connect to CC2 on USB Type-C connector.  |
| B2             | FSUS                      | Force Suspend Input. Logic-high on this pin causes the input limiter to open and input current from CHGIN is reduced to zero. This pin is internally pulled to GND through a 470k $\Omega$ (typ) resistor and has no effect if FSUSMsk = 1.  |
| B3             | DGND                      | Digital Ground.  |
| B4             | V <sub>TPU</sub>          | External Voltage Input for TPU connection. Connect to external supply or V <sub>CCINT</sub> .  |
| B5             | BREG                      | Bypass for Internal Switching Converter Supply. Bypass with 1 $\mu$ F capacitor to AGND.   |
| B6–B9          | SYS                       | System Load Connection. Connect SYS to the system load. Bypass to PGND with a parallel combination of a 0.1 $\mu$ F capacitor and an effective 22 $\mu$ F capacitor. (Note: there is a diode between SYS and BAT)  |
| C1             | V <sub>CONN</sub>         | External V <sub>CONN</sub> Supply Input. Leave unconnected if not used.  |
| C2             | SCL                       | I <sup>2</sup> C Serial Clock Input. Connect an external pull-up resistor.   |
| C3             | V <sub>CCINT</sub>        | Bypass For Internal Analog Supply. Bypass with 1 $\mu$ F capacitor to GND.   |
| C4, D4, D5     | GND                       | Ground.  |
| C5             | BST                       | Charge Pump Connection. Connect a 0.1 $\mu$ F capacitor between BST and LX.  |
| C6, C7, C8, C9 | LX                        | Switching Node of Boost Converter. Connect a 1.5 $\mu$ H or 2.2 $\mu$ H inductor between LX and BYP. See <i>Applications Information</i> section for more details.   |
| D1             | CC1                       | USB Type-C CC1. Connect to CC1 on USB Type-C connector.  |
| D2             | SDA                       | I <sup>2</sup> C Serial Data Input/Output. Connect an external pullup resistor.  |
| D3             | $\overline{\text{INT}}$   | Active-Low, Open-Drain Interrupt Output. Connect an external pullup resistor.  |
| D6, D7, D8, D9 | PGND                      | Power Ground.  |



## Bump Descriptions (continued)

| BUMP  | NAME  | FUNCTION   |
|-------|-------|--|
| E1    | CDN   | USB Connector D-Input. Leave unconnected if not used.  |
| E2    | LED   | LED Charging Status Indicator. Open-drain output indicating battery charging status. When LEDAuto = 1 and a temperature fault is detected, the output is pulsed at 50% duty cycle for a period of 1.5s. When a charge timer expires or SysFlt fault occurs, LED is pulsed at 50% for a period of 0.15s. When LEDAuto = 0, the open-drain output is controlled by the LEDCtrl bit. Connect this pin to GND if unused. |
| E3    | THM   | Battery Temperature Thermistor Measurement Connection. This pin is used for NTC thermistor presence detection and JEITA compliant temperature control.   |
| E4    | SFOUT | Output of overvoltage protected LDO powered from CHGIN. Bypass SFOUT with a 1µF ceramic capacitor to GND.  |
| E5    | CDIR  | USB Cable Orientation Open-drain Output. When CC1 is active, this output is pulled low. Otherwise, this output is high-impedance. Leave unconnected if not used.   |
| E6–E9 | BYP   | Bypass Connection. Bypass to PGND with a parallel combination of a 0.1µF capacitor and an effective 10µF capacitor.  |
| F1    | CDP   | USB Connector D+ Input. Leave unconnected if not used.   |
| F2    | TDP   | USB Transceiver D+ Connection. Connect TDP to device microprocessor USB transceiver D+ line. Leave unconnected if not used.  |
| F3    | TDN   | USB Transceiver D- Connection. Connect TDN to device microprocessor USB transceiver D- line. Leave unconnected if not used.  |
| F4    | BVCEN | External V <sub>CONN</sub> Supply Enable Output. Push-pull output between V <sub>CCINT</sub> and GND. Leave unconnected if not used.   |
| F5    | NVP   | Negative Voltage PFET Gate Control. Leave unconnected if not used.   |
| F6–F9 | CHGIN | USB Charger Input. Bypass this pin with a 1µF capacitor to PGND.   |

**Note:** All capacitance values listed in this document refer to effective capacitance. Be sure to specify capacitors that will meet these requirements under typical system operating conditions taking into consideration the effects of voltage and temperature.

Block Diagram

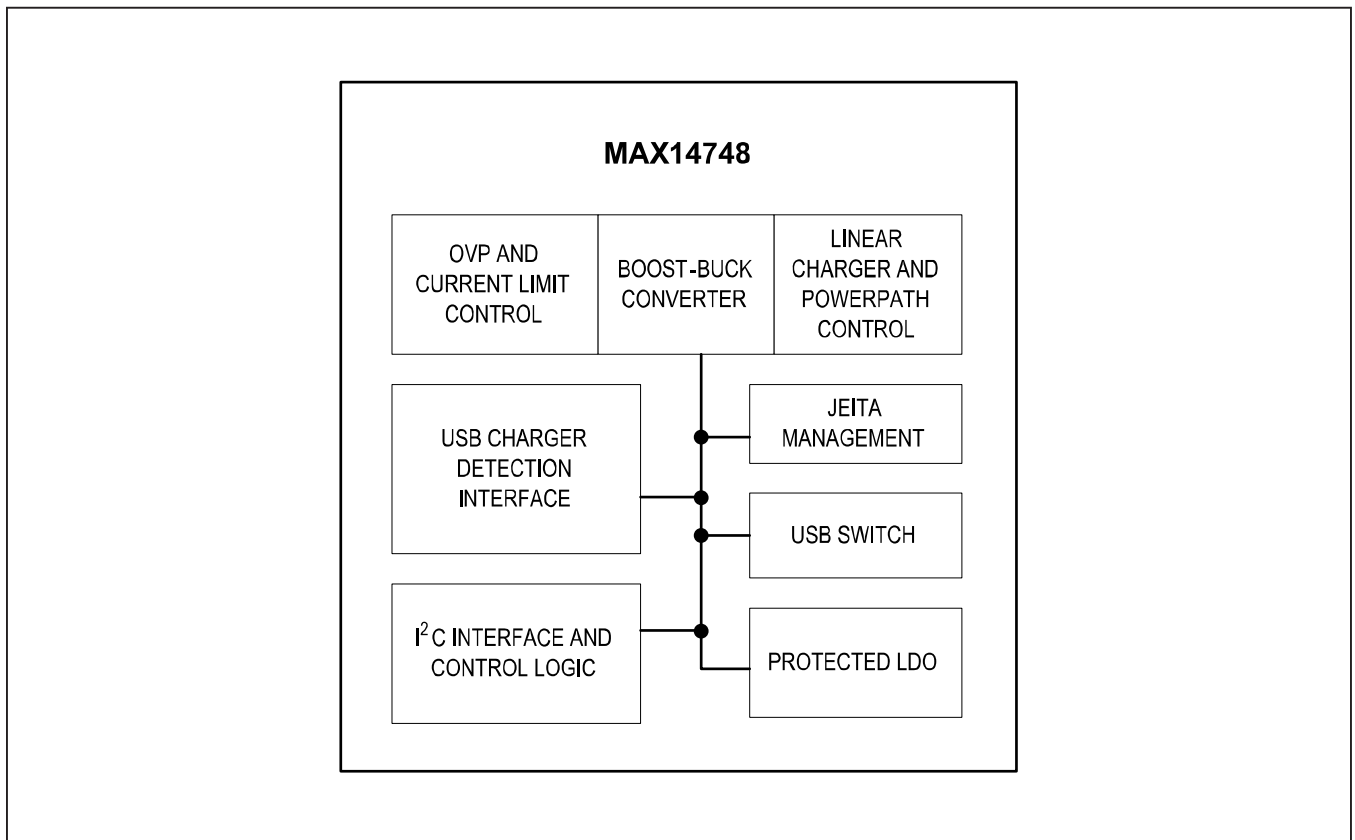

## Detailed Description

The MAX14748 is a battery charger with a Smart Power Selector that safely charges two Li+ cell in accordance with JEITA specifications\*.

### Input OVP

The MAX14748 CHGIN input is protected by an internal N-channel FET. The device monitors the voltage at CHGIN and, if CHGIN is greater than  $V_{OVP}$ , switches off the internal FET to prevent damage to the device. If  $V_{CHGIN}$  is above the overvoltage threshold or below the USB valid voltage threshold, the MAX14748 enters overvoltage lockout (OVLO). During OVLO, the internal circuits remain powered, the SYSOK pin is high-impedance, and an interrupt is asserted. During OVLO, the charger turns off and the system load switch closes, allowing the battery to power SYS.

### Negative Voltage Protection (NVP)

The MAX14748 provides a gate protection circuit for an external PFET that protects against negative voltages on  $V_{BUS}$ . NVP pin drives the gate of the external PFET. If a negative voltage is present on  $V_{BUS}$  (e.g., by a backwards connector) the NVP turns off the external PFET, therefore providing negative voltage protection.

### Low Power Mode

The MAX14748 features a Low Power mode, which reduces the battery current consumption from 25 $\mu$ A to 140 $\mu$ A. To enter Low Power mode, write 1 to LowPowEn (Register 0x33[7]). To manually exit Low Power mode, set LowPowAbort (Register 0x33[1]) to 1. If a DFP pullup connect to CC1/CC2 is detected, the device automatically exits Low Power mode and resumes normal operations.

### Input Current Limiter

The primary function of the input limiter is supplying power from the external adapter at CHGIN to the system load and battery charger. In addition, it performs several other functions to optimize use of the available power efficiently and safely, including:

- 1) CHGIN Input Current Limiting: The CHGIN input current is limited to prevent input overload. The current limit can be automatically selected through charger detection to match the capabilities of the source. The result is indicated by SpvChgLim[4:0] in register 0x22. See [Table 1a](#) for more details. It can also be manually set through CurLim1Frc and CurLim1Set[4:0] in register 0x21. [Figure 1](#) illustrates how the current limit setting is selected.
- 2) Thermal Limiting: In case the die temperature exceeds the normal limit ( $T_{CHG\_LIM}$ ), the MAX14748 will attempt to limit temperature increase by reducing the input current at CHGIN. In this condition, the system load has priority over charger current, so the input current is first reduced by lowering the charge current. If the junction temperature continues to rise and reaches the maximum operating limit ( $T_{BUS\_LIM}$ ), no input current is drawn from CHGIN and the battery powers the entire system load.
- 3) Adaptive Battery Charging: While the system is powered from CHGIN, the charger draws power from SYS to charge the battery. If the total load exceeds the input current limit, the battery supplies supplemental current to the load.
- 4) Adaptive Input Current Limiting: If the MAX14748 input current limit is programmed in such a way that the adapter voltage collapses due to resistive drop, current limiting, or poor load transient response, the AICL loop allows the MAX14748 to regulate the input voltage above a value needed to ensure proper operation. [Figure 2](#) illustrates high-level operation of the AICL block and associated parameters are found in the registers 0x2C to 0x2E.

\*JEITA (Japan Electronics and Information Technology Industries Association) Standard, A Guide to the Safe Use of Secondary Lithium Ion Batteries on Notebook-Type Personal Computers, April 20, 2007.

Table 1a. Automatic Input Current Limit Control

| ChgTyp[1:0]  | PrChgTyp[2:0]                              | CCiStat[1:0]                              | SDPMaxCur[1:0] | CDPMaxCur[1:0] | I <sub>LIM</sub> | SpvChgIlim[4:0] |
|--------------|--|---|----------------|----------------|------------------|-----------------|
| "xx"         | "xxx"                                      | "11 = 3A"                                 | "00"           | "0"            | 3A               | 0x1D            |
| "11 = 1.5A"  | "xxx"                                      | "11 = 3A"                                 | "xx"           | "x"            | 3A               | 0x1D            |
| "xx"         | "110 = 3A"                                 | "xx"                                      | "xx"           | "x"            | 3A               | 0x1D            |
| "xx"         | "101 = 2.4A"                               | "00" or<br>"01 = 500mA" or<br>"10 = 1.5A" | "xx"           | "x"            | 2.4A             | 0x17            |
| "xx"         | "100 = 2A" or<br>"001 = 2A"                | "00" or<br>"01 = 500mA" or<br>"10 = 1.5A" | "xx"           | "x"            | 2A               | 0x13            |
| "1x = 1.5A"  | "000" or<br>"010 = 500mA"                  | "00" or<br>"01 = 500mA" or<br>"10 = 1.5A" | "xx"           | "x"            | 1.5A             | 0x0E            |
| "1x = 1.5A"  | "000" or<br>"010 = 500mA"<br>or "011 = 1A" | "10 = 1.5A"                               | "xx"           | "x"            | 1.5A             | 0x0E            |
| "xx"         | "011 = 1A"                                 | "00" or<br>"01 = 500mA"                   | "xx"           | "x"            | 1A               | 0x09            |
| "01 = 500mA" | "000" or "010 =<br>500mA"                  | "00" or<br>"01 = 500mA"                   | "xx"           | "x"            | 0.5A             | 0x04            |
| "01 = 500mA" | "000"                                      | "10 = 1.5A" or<br>"11 = 3A"               | 01             | "x"            | 0.5A             | 0x04            |
| "01 = 500mA" | "000"                                      | "10 = 1.5A" or<br>"11 = 3A"               | 10             | "X"            | 1.0A             | 0x09            |
| "01 = 500mA" | "000"                                      | "10 = 1.5A" or<br>"11 = 3A"               | 11             | "x"            | 1.5A             | 0x0E            |
| "10 = 1.5A"  | "000"                                      | "11 = 3A"                                 | xx             | "1"            | 1.5A             | 0x0E            |
| "00"         | "xxx"                                      | "xx"                                      | "xx"           | "x"            | NA               | NA              |

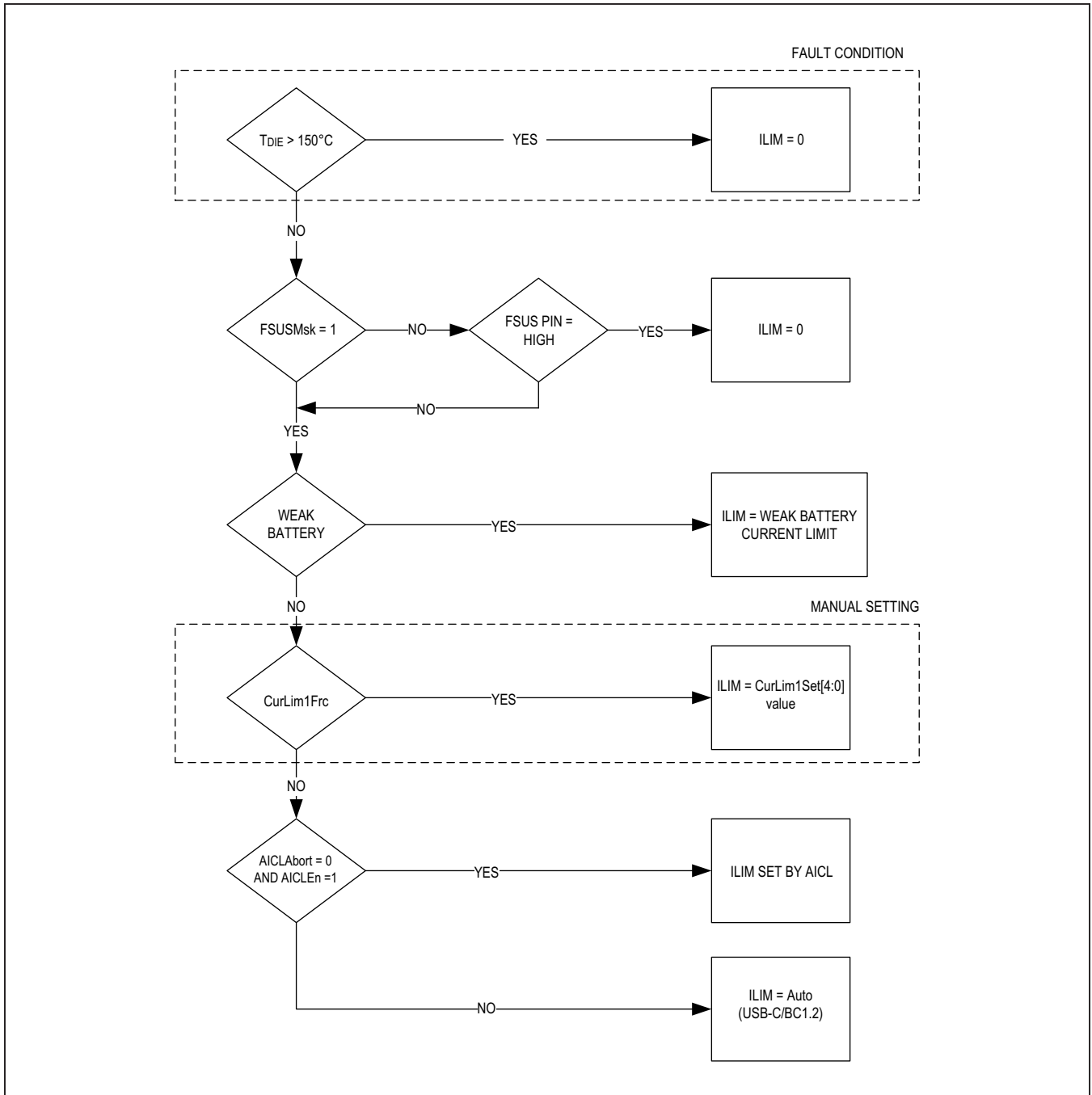

Figure 1. Input Current Limit Settings Flow Diagram

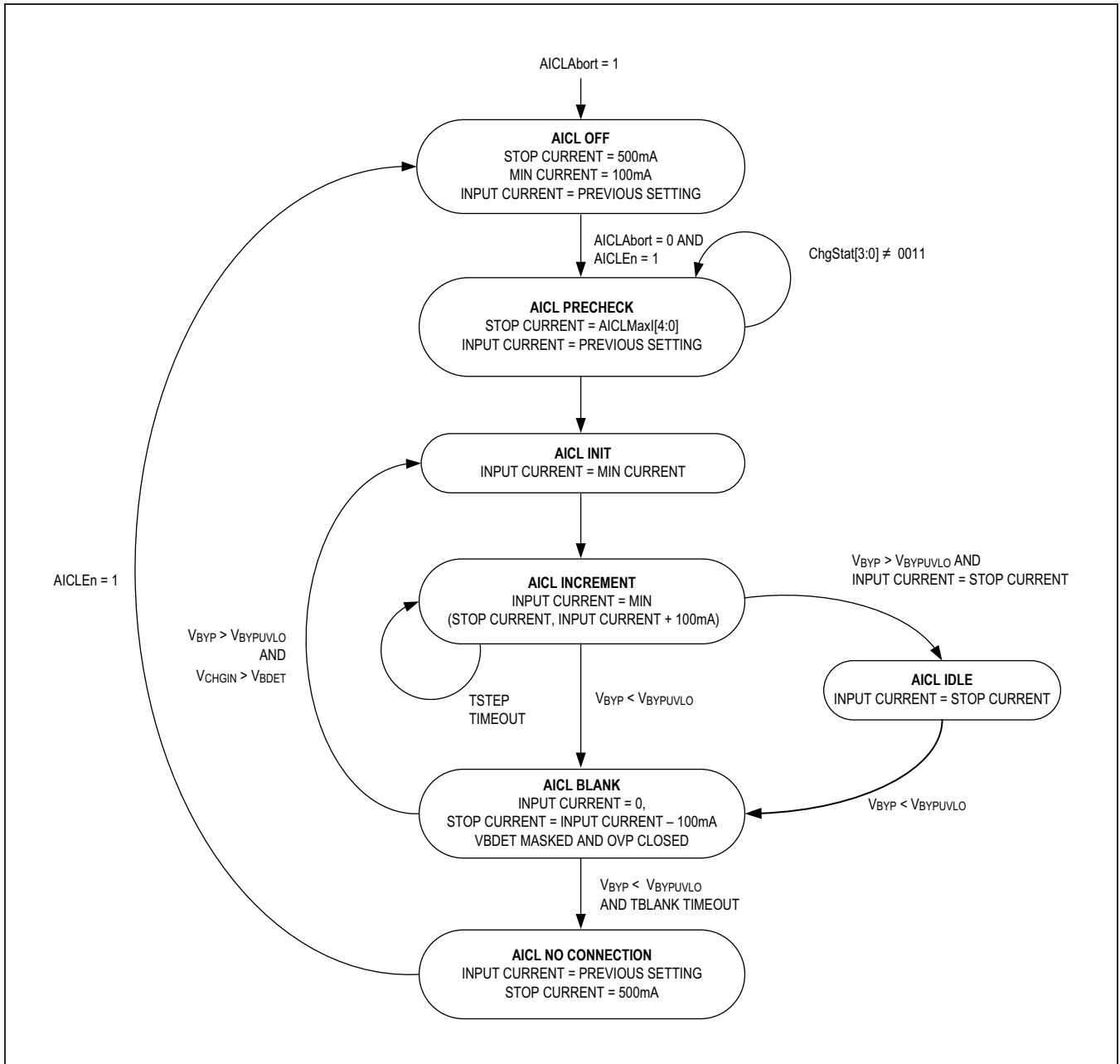

Figure 2. AICL Operation Flow Diagram

## Boost Converter with Reverse Buck

### Boost Mode

The MAX14748 boost converter operates as either a current-limited voltage source, or current source, depending on the charger operational state. When a valid USB voltage is present at CHGIN, and the charger is disabled,  $V_{SYS}$  is regulated to  $V_{BAT} + 400mV$ . If the charger is in precharge mode,  $V_{SYS}$  is regulated to  $V_{PCHG} + 400mV$ . When the system is in fast-charge mode, the boost converter operates as a current source, delivering current into the SYS node that is shared by the battery and system loads.

The boost converter current limit may be acted upon by multiple system blocks, including the programmed input current limit, thermal status, charging current, SYS regulation voltage block, and battery termination voltage block. The minimum requested current from these blocks at any given time determines the active current limit in the boost.

### Reverse Buck Mode

The CHGIN-SYS switching converter may operate as a buck converter when needed to supply a load attached to CHGIN. The load may be a Type-C sink or some other proprietary device.

If Type-C DRP operation is enabled, the buck converter can be enabled by the Type-C state machine. The output voltage of the buck can be programmed from 4V to 5.5V in 0.1V steps by writing to BuckVSet[3:0], however, it is not recommended to change the output voltage when the buck is active.

The output of the buck converter turns off when a fault occurs. The specific fault occurred is indicated by DCDCILim, DCDCRunAway, DCDCPGood status bits (register 0x04). See [I2C Register Descriptions](#) for more details. When the buck is disabled due to a fault, both VBUSDet (register 0x07) and VSAFE0V (register 0x0A) change to 0. After the fault condition is removed, the buck converter can be restarted by writing 1 to CCSnkRst, CCSrcRst, CCForceError, or USBCRset auto-reset bits.

### Smart Power Selector

The Smart Power Selector seamlessly distributes power between CHGIN, battery (BAT) and the system (SYS). The basic modes of operation of the smart power selector are:

1. With a valid external power source:
  - a. The external power source at CHGIN is the primary source of energy.
  - b. The battery is the secondary source of energy.
  - c. Energy delivery to SYS is the highest priority.
  - d. Any energy that is not required by SYS is available to the battery.
2. With no power source available at CHGIN:
  - a. The battery is the primary source of energy.
  - b. Energy delivery to SYS has the highest priority.
3. With a Type-C Sink or other load present at CHGIN:
  - a. The battery is the primary source of energy.
  - b. Energy delivery to SYS is the highest priority.
  - c. Energy delivery to BYP is the second highest priority.

4. SYS Regulation Voltage:
  - a. When the charger path is enabled and the charger is disabled,  $V_{SYS}$  is regulated to  $V_{BAT} + 400mV$  and BAT switch is off.
  - b. When the charger is enabled but in a non-charging state such as maintain charge done, thermistor suspend, or timer fault,  $V_{SYS}$  is regulated to  $V_{BAT} + 400mV$  and BAT switch is off.
  - c. When the input charger path is enabled and the battery is charging in prequalification,  $V_{SYS}$  is regulated to  $V_{PCHG} + 400mV$ . Charge current is reduced when  $V_{SYS}$  approaches  $V_{PCHG} + 200mV$ .
  - d. When the input charger path is enabled and the battery is charging in fast-charge or maintain charge done, the BAT switch is closed and  $V_{SYS} = V_{BAT}$ . In maintain charge done state, the connection between SYS and BAT acts as an ideal diode. Therefore, when  $V_{SYS}$  drops below  $V_{BAT}$ , the BAT switch is turned fully on and the battery supplements the SYS load along with the current from CHGIN.
  - e. When the switching converter is enabled as a reverse buck, the BAT switch is closed and  $V_{SYS} = V_{BAT}$ .

### Short-Circuit Protection

The MAX14748 provides short-circuit protection to the power nodes. When SYS is shorted to ground, input current from CHGIN is limited by boost converter current limit. Note in this case, FET diode from BAT-SYS prevents control of FET BAT-SYS current. Battery current is not limited by the MAX14748 and a pack protector is needed to limit the battery current.

When either BYP or CHGIN is shorted to ground, the current from BAT is limited by the reverse buck converter.

### USB Type-C 1.1

#### USB Type-C 1.1 UFP and DRP Support

The MAX14748 provides support for devices functioning as a Upstream Facing Port (UFP) or Dual Role Port (DRP) per the current USB Type-C 1.1 specification. When acting as a power source in DRP mode, the MAX14748 can provide a 5V  $V_{BUS}$  on the CHGIN pin through operation of the reverse buck converter. The USB Type-C  $V_{CONN}$  supply is provided externally via the  $V_{CONN}$  pin, and switched internally onto one of the CC pins. An open-drain output pin, BVCEN, is provided to enable the external  $V_{CONN}$  supply based on the Type-C state machine output. BVCEN is a push-pull output between GND and  $V_{CCINT}$ .

#### USB BC1.2 Compliant and Nonstandard Charger Support

The BC1.2 charger detection and special charger detection routine is embedded within the Type-C state machine. The BC1.2 and Special Charger detection routine runs always when the state machine enters the 'AttachWait.SNK' state of the USB Type-C 1.1 state-machine.

#### USB Type-C Adapter Insertion

[Figure 3a](#) and [Figure 3b](#) depict the general timings when a USB Type-C adapter is attached. For more information on the behavior and timings of the USB Type-C 1.1 state-machine, please refer to the USB Type-C specification.



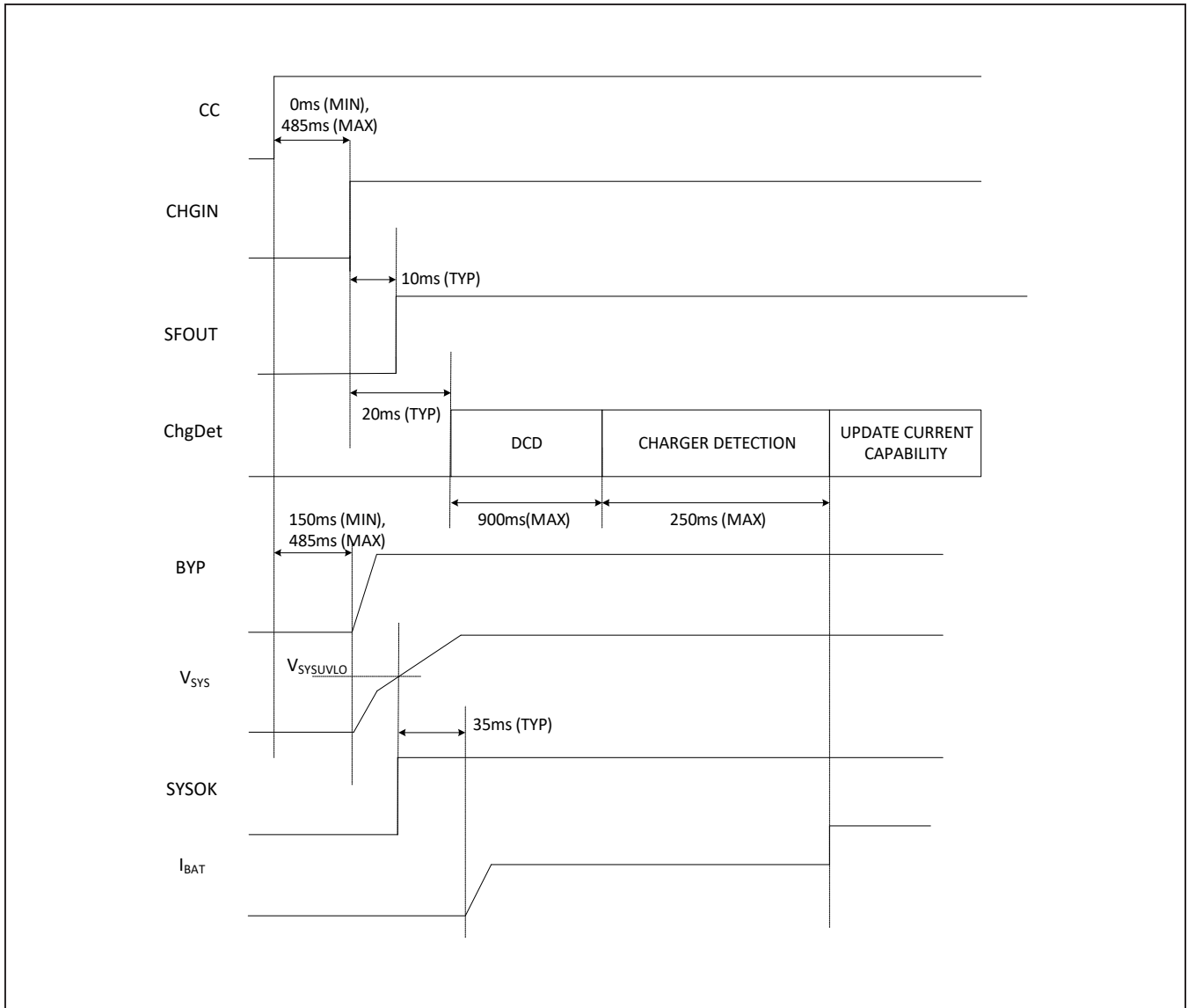

Figure 3a. Type-C Adapter Insertion (CHGINILimGate = 0)

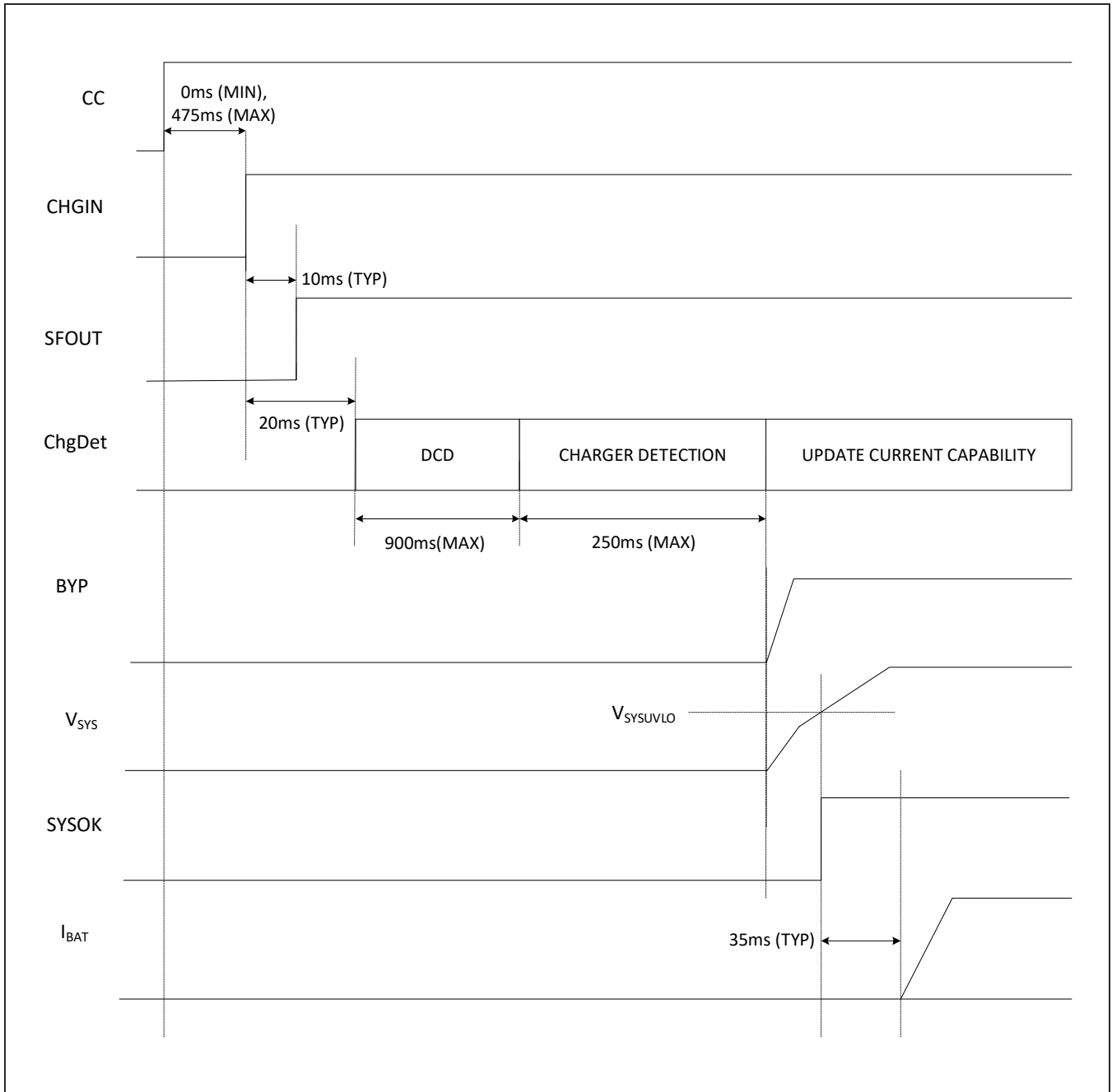

Figure 3b. Type-C Adapter Insertion (CHGINLimGate = 1)

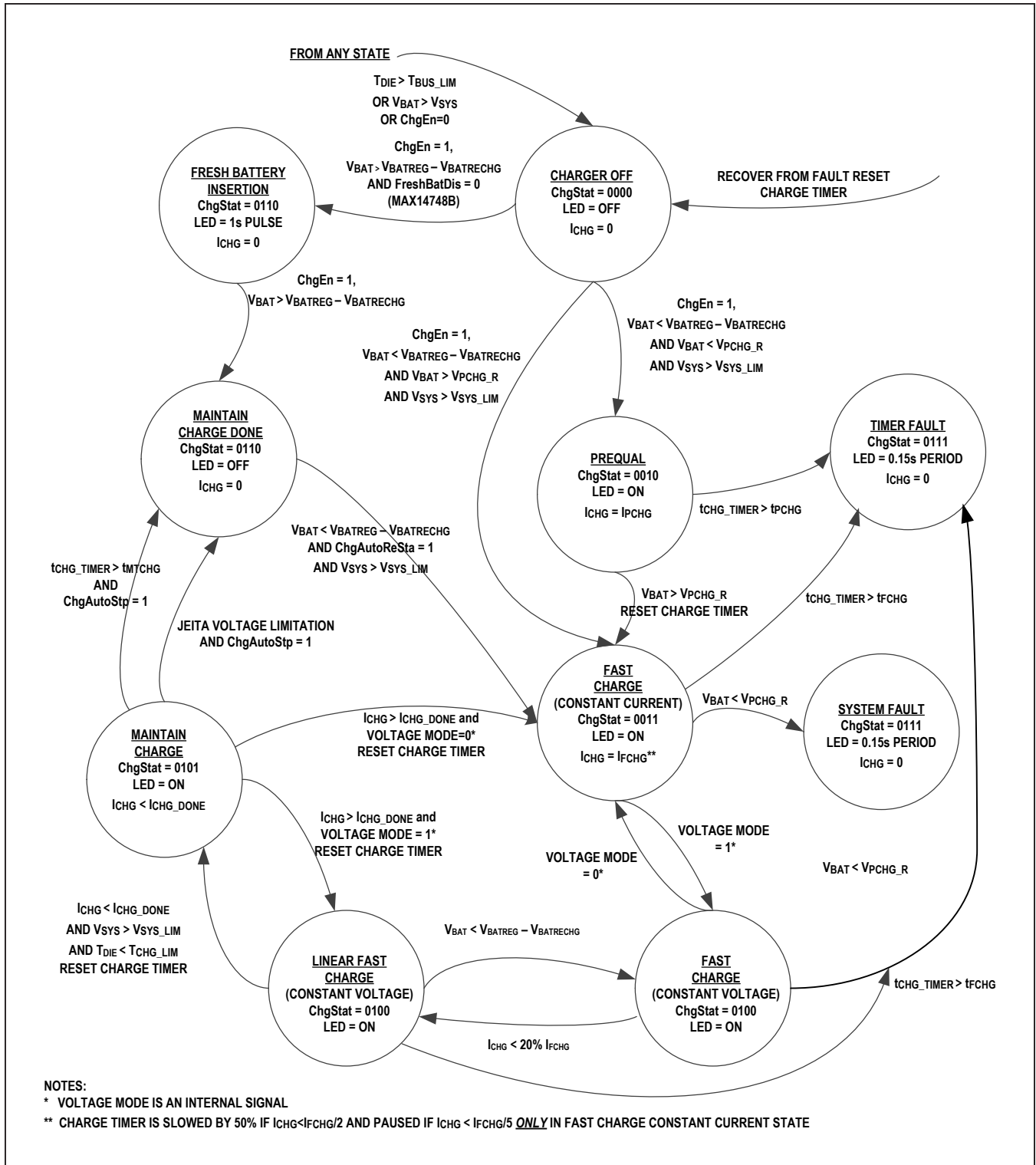

Figure 4. Battery Charger State Diagram

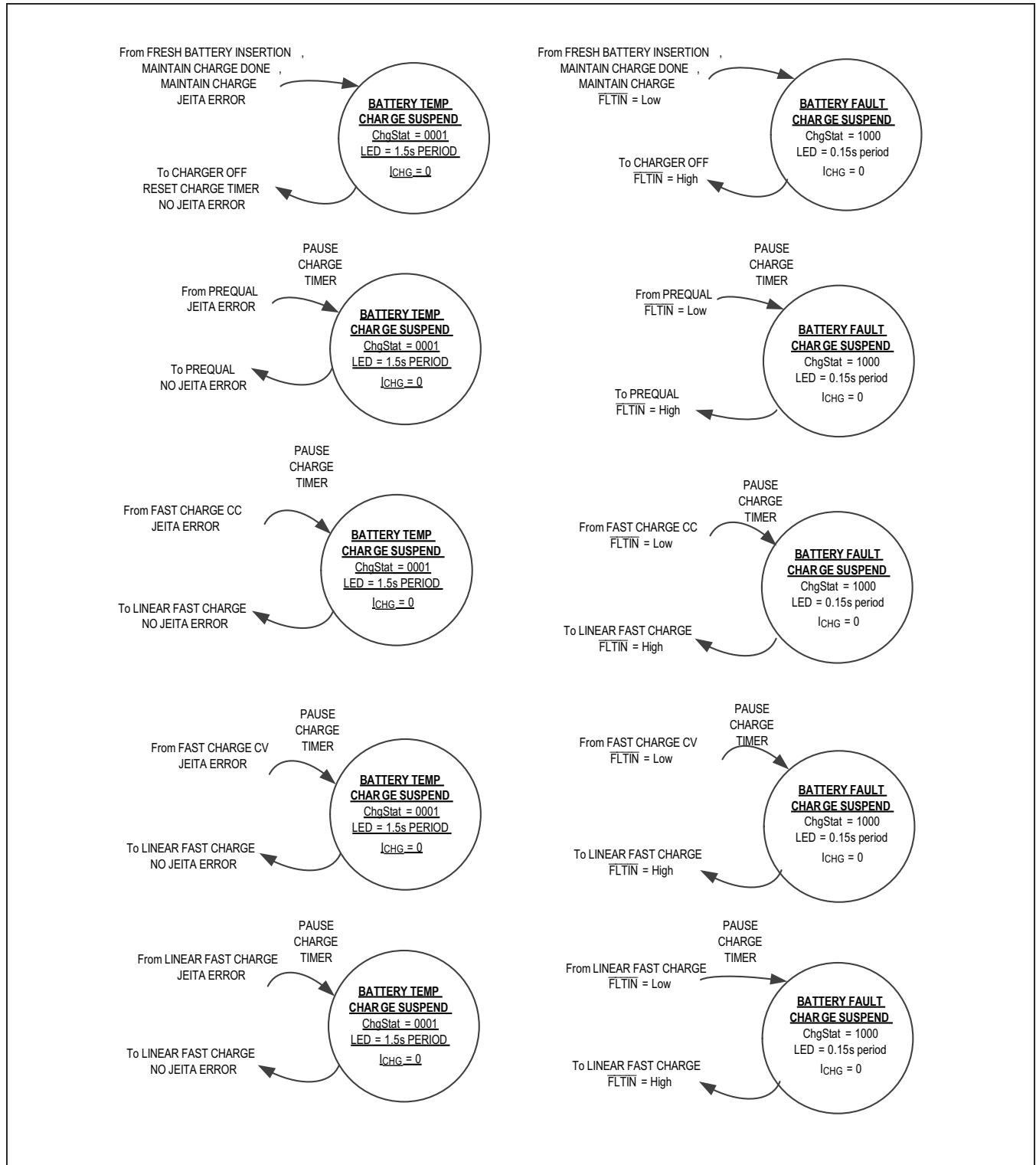

Figure 5. Battery Charger State Diagram (continued)

## Li-ion Battery Charger

### Charger Overview

The MAX14748 utilizes a boost converter to generate the necessary voltage to charge a 2s Li-ion battery from a nominal 5V USB charger input. Depending on the charging phase, the boost converter will operate as either a current-limited voltage source or current source. The charger is configured through a combination of external components and I<sup>2</sup>C registers settings. See [Figure 4](#) and [Figure 5](#) for the *Battery Charger State Diagram*. Note, for MAX14748, do not remove the battery while the charger is enabled (ChgEn=1).

### Precharge

In precharge and charge termination phases, the boost converter functions as a current-limited voltage source and regulates V<sub>sys</sub> to V<sub>PCHG</sub> +400mV. The battery is charged through an internal linear charging path with a maximum precharge current of 500mA (subject to thermal limitations), programmable through I<sup>2</sup>C. The precharge/fast-charge thresholds can be configured through register 0x1E and may not be less than the V<sub>OVP</sub> (max).

### Fast Charge

In the fast-charge phase, the boost converter functions as a current source delivering current into the SYS node. The SYS and BAT nodes are shorted together through the BAT-SYS FET, with a nominal resistance of 13mΩ (typ). The fast-charge current is set by an external resistor, but may be modified by the T\_T\_IFchg[2:0] bits in registers 0x1A and 0x1B. The fast-charge current resistor can be calculated as  $R_{SET} = K_{SET}/I_{FCHG}$ , where K<sub>SET</sub> has a typical value of 10000A/A. The range of acceptable resistors for R<sub>SET</sub> is 3.3kΩ to 100kΩ.

### Charge Termination

During the charge termination phase, the battery current is monitored across the BAT-SYS FET. To prevent a 'false' termination of charge, the charge done condition is qualified by the state of the input current limit; if the input current limit is currently active, the charge done condition is not triggered. The charge done condition is also debounced for 140μs in order to prevent transient system currents from triggering an incorrect done condition.

### Thermistor Monitoring

The MAX14748 provides highly programmable thermal/ JEITA charge management. All thermal/JEITA charge

configuration parameters are set via the ThermCfg registers 0x1A - 0x1C. The charger is managed by thermal information only if JEITACtrSet = 1.

The battery pack temperature is measured from a divider formed by a pull-up resistor, an optional parallel resistor, and the battery pack thermistor. When required, the pullup resistor is connected to an internal supply through the TPU input, and the voltage on the THM pin is compared to an internal threshold. The supply voltage for the divider is applied to the V<sub>TPU</sub> pin and may be connected to an external supply or to V<sub>CCINT</sub>. The pullup resistor may be complemented with an additional parallel resistor to allow matching to different thermistor nominal values and charging cutoff temperatures, T1, T2, T3, and T4. There are two sets of cutoff temperatures optimized for a thermistor with Beta = 3380 (0°C/10°C/45°C/60°C or 0°C/10°C/25°C/45°C) which can be selected as factory default options. These cutoff temperatures divide the temperature range into three zones, T1\_T2, T2\_T3, and T3\_T4. The charger is always turned off at temperatures outside these zones when any thermal monitoring mode is enabled. If the system needs to measure the THM temperature when not charging, the internal pullup switch may be enabled through the JeitaCfgR[1:0] bits.

Charging may be optionally disabled in the T1\_T2 and T3\_T4 zones through the T\_T\_EnSet bits. The charge current in each zone may be modified through T\_T\_IFchg[2:0]. Battery-voltage termination reduction may also be selectively applied through the T\_T\_VFset bits. See [Figure 6](#) for more details.

### Weak Battery Operation

The MAX14748 supports the weak battery provision of the USB 2.0 specification. If an SDP adapter is detected and the battery voltage is less than the precharge threshold, the input current limit is set to 500mA and a 2-minute timer starts. After the 2-minute timer expires, the input current limit is set to zero. Any time during the 2-minute countdown, the system may turn off the weak battery state machine and assert control of the input current limit by setting WeakBatEn to 0.

### Battery Detection

The MAX14748 offers battery detection by detecting the presence of the battery thermistor. If the thermistor is not present, THM is pulled high by the external pullup resistor, and BatDet is set to 0 indicating that the battery is not connected.

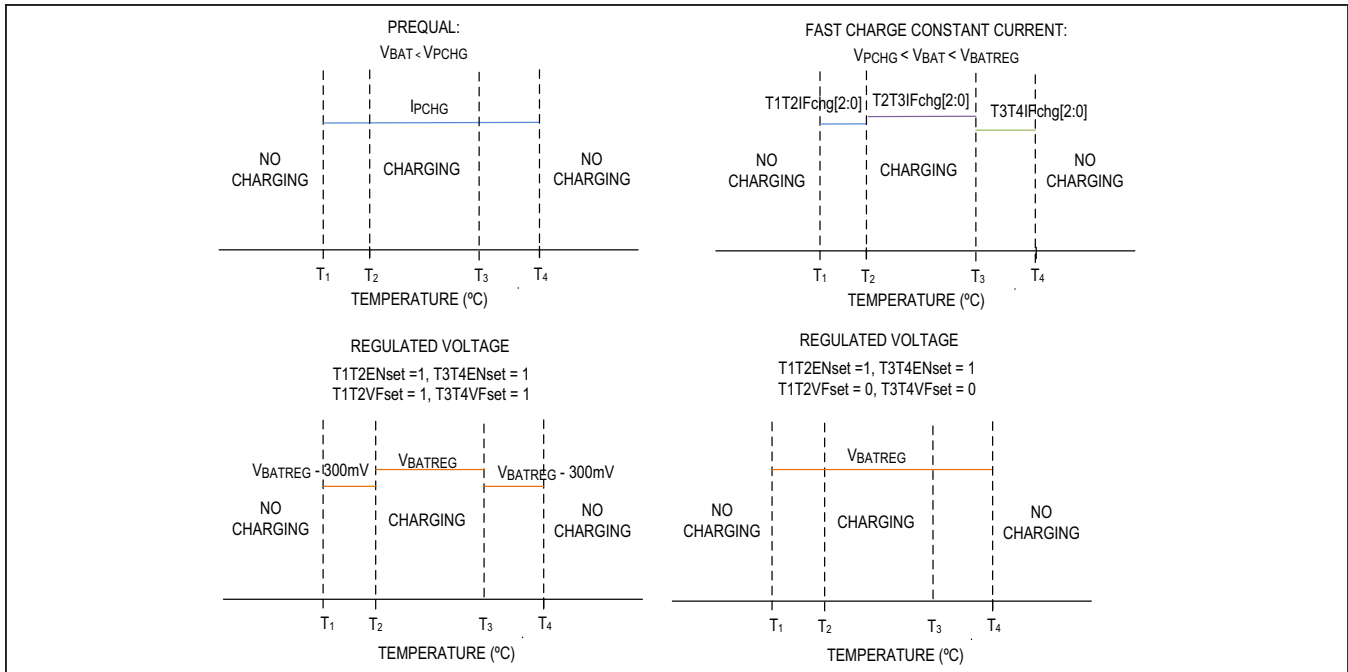

Figure 6. Thermistor Monitoring

### Deeply Discharged Battery

Pack protectors that have a diode in series with the battery cell during recovery can cause the BAT voltage to rise above the precharge threshold of the charger. In the battery recovery state, if  $V_{CELL} + 0.6V > V_{PCHG}$ , the fast-charge state can be entered prematurely, eventually triggering a system fault. To avoid this issue in these pack protectors, ChgEn bit of ChargerCtr1 register (0x1D) can be controlled by the application processor in a manner such that charger does not enter fast charge mode until the battery pack successfully recovers from the deeply discharged state. The recommendation is to set ChgEn to 1 for 60ms to charge the battery in precharge mode followed by resetting ChgEn to 0 for 1ms to prevent the charger from entering fast-charge mode prematurely. This 60ms/1ms combination should be repeated until the battery pack successfully recovers. The total time to a successful recovery can be shortened by using a higher fast-charge current level IFCHG and a higher precharge current setting IPCHG. It is also recommended to use the highest setting for the prequalification threshold VPCHG.

### Integrated USB 2.0 Analog Switch

A high-speed USB switch is integrated to provide the host data access to the connected USB device when an SDP or CDP port is detected. The analog switch may

be controlled manually or automatically by configuring the AnSwCntl[1:0] bits in register 0x2F. When the analog switch control is set to the auto control setting then the CDN/CDP pins are connected to TDN/TDP only when a SDP or CDP port is detected. (See [I2C Register Descriptions](#) for further details.)

### SFOUT LDO

The SFOUT LDO is powered directly from the CHGIN input and may be used to power a USB transceiver, or as an indicator signal that a SDP/CDP port is present. The LDO will operate with CHGIN voltages greater than  $V_{BDET}$ . The output voltage of SFOUT is selectable as either 5V or 3.3V through the SfOutLvl bit, depending on the system preference. SFOUT may be programmed to turn on automatically when an SDP or CDP is detected, or placed in manual mode and turned on through an I2C command. This supply is always available when CHGIN is present.

### Internal Supplies and Regulators

The MAX14748 has two internal power supplies: VCCINT and BREG. VCCINT and BREG are always present when CHGIN or BAT is present. These supplies share a common source, but bypassed separately. The VCCINT and BREG supplies require external bypass capacitors and are regulated to a nominal value of 4.3V (typ).

### Device Control Interface

While the MAX14748 is primarily controlled by I<sup>2</sup>C, GPIO control is also offered for specific functions. The following GPIO control signals are provided (note that these signals only apply when CHGIN is present):

- 1) FSUS (Input): Force Suspend. This pin enables the host microcontroller to force the input current limit to zero. When CHGIN is present, a logic-high on the pin causes the input OVP FET at CHGIN to open and the input current to MAX14748 is reduced to less than 2mA. This pin has no effect if FSUSMsk = 1.
- 2) FLTIN (Input): Battery Fault Input. This pin allows the system or battery pack to place the charger into a fault condition using a GPIO pin. See Register 0x35 description for more details.
- 3) CDIR (Open-Drain Output): USB Superspeed MUX control. In USB Type-C plug configurations, it is necessary to detect the orientation of the connector and route the Superspeed lines accordingly. The pin can be used to automatically configure a USB Superspeed MUX according to the orientation information contained in the integrated Type-C detection block. (This information is also available through I<sup>2</sup>C) The

CDIR output is pulled to GND when the CC1 pin is active on the Type-C connector, otherwise it is high-impedance.

- 4) SYSOK (Open-Drain Output): With CHGIN present, the SYSOK output is asserted if the boost regulator generates a V<sub>SYS</sub> greater than SYS UVLO threshold, V<sub>SYSUVLO</sub>. Otherwise, the output is high-impedance. This pin can be used as wake up the host system from a dead-battery. Note that when V<sub>SYS</sub> falls below the SYS UVLO falling threshold, the input OVP switch is opened as the boost converter cannot operate in this state.
- 5) BVCEN (Open-Drain Output): When CHGIN is present and a Type-C device that requires V<sub>CONN</sub> is found, this pin is asserted. This pin should be connected to the enable pin of the V<sub>CONN</sub> power supply enable. The output of BVCEN is push-pull between GND and V<sub>CCINT</sub>.

### System Faults

The MAX14748 monitors the system for faults including OVP Soft Start Timeout, SYS UVLO, Direct Charging Fault, Charger Timeout, Forced Charger Fault, Dead Battery, CHGIN OVP. See [Table 1b](#) for more details.

**Table 1b. System Faults Summary**

| FAULT NAME             | EFFECT  | CAUSE DESCRIPTION   | HOW TO RECOVER  | STAUS BIT               |
|------------------------|---|---|---|-------------------------|
| OVP Soft-Start TimeOut | System Fault Condition Latched. OVP/Boost/Charger Off | UFP: V <sub>BYP</sub> is not within 50mV of V <sub>CHGIN</sub> at Soft Start TimeOut (100ms typ)  | Unplug/Replug Type-C cable or reset device via USBCRSet of Reg 0x30 | SysFlt (Reg 0x02)       |
| SYS UVLO               | System Fault Condition Latched. OVP/Boost/Charger Off | UFP: V <sub>SYS</sub> falls below SYS UVLO threshold while in Boost mode or V <sub>SYS</sub> fails to reach above SYS UVLO threshold within 20ms after V <sub>BYP</sub> rises | Unplug/Replug Type-C cable or reset device via USBCRSet of Reg 0x30 | SysFlt (Reg 0x02)       |
| Direct Charging Fault  | Charger Fault Condition Latched. Charger Off          | UFP: V <sub>BAT</sub> falls below V <sub>PCHG</sub> while in Fast Charge mode   | Cycle ChgEn or treat as System Fault                                | DirChgFault (Reg 0x05)  |
| Charger Timeout        | Charger Fault Condition Latched. Charger Off          | UFP: Pre-charge or Fast-charge Timer expires  | Cycle ChgEn or treat as System Fault                                | ChgStat[3:0] (Reg 0x05) |
| Forced Charger Fault   | Charger Off   | UFP: Logic-low applied on FLTIN pin   | Logic-high applied on FLTIN pin                                     | ChgStat[3:0] (Reg 0x05) |
| Dead Battery           | System Fault Condition Latched. OVP/Boost/Charger Off | UFP: DeadBattery detection enabled and SDP detected: V <sub>BAT</sub> fails to reach above V <sub>PCHG</sub> within 2min  | Treat as System Fault or disable DeadBattery                        | WbChg (Reg 0x02)        |
| CHGIN OVP              | OVP/Boost/Charger OFF                                 | V <sub>CHGIN</sub> rises above V <sub>OVP</sub>   | Reduce V <sub>CHGIN</sub> below V <sub>OVP_F</sub>                  | ChginOVP (Reg 0x02)     |

### I<sup>2</sup>C Interface

The MAX14748 contains an I<sup>2</sup>C-compatible interface for data communication with a host controller (SCL and SDA). The interface supports a clock frequency of up to 400kHz. SCL and SDA require pullup resistors that are connected to a positive supply.

### Start, Stop, And Repeated Start Conditions

When writing to the MAX14748 using I<sup>2</sup>C, the master sends a START condition (S) followed by the MAX14748 I<sup>2</sup>C address. After the address, the master sends the register address of the register that is to be programmed. The master then ends communication by issuing a STOP condition (P) to relinquish control of the bus, or a REPEATED START condition (Sr) to communicate to another I<sup>2</sup>C slave. See [Figure 7](#).

**Table 2. I<sup>2</sup>C Slave Addresses**

| ADDRESS FORMAT | HEX  | BINARY   |
|----------------|------|----------|
| 7-Bit Slave ID | 0x0A | 0001010  |
| Write Address  | 0x14 | 00010100 |
| Read Address   | 0x15 | 00010101 |

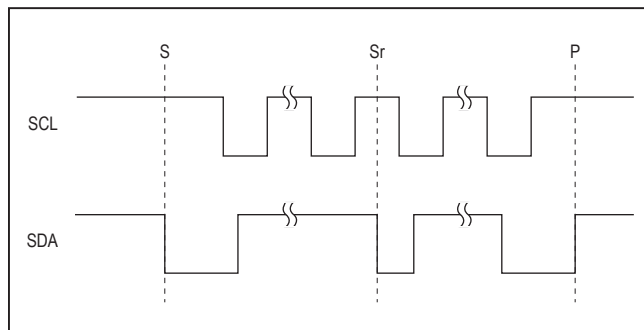

Figure 7. I<sup>2</sup>C START, STOP and REPEATED START Conditions

### Slave Address

Set the Read/Write bit high to configure the MAX14748 to read mode ([Table 2](#)). Set the Read/Write bit low to configure the MAX14748 to write mode. The address is the first byte of information sent to the MAX14748 after the START condition.

### Bit Transfer

One data bit is transferred on the rising edge of each SCL clock cycle. The data on SDA must remain stable during the high period of the SCL clock pulse. Changes in SDA while SCL is high and stable are considered control signals (see the [Start, Stop, And Repeated Start Conditions](#) section). Both SDA and SCL remain high when the bus is not active.

### Single-Byte Write

In this operation, the master sends an address and two data bytes to the slave device ([Figure 8](#)). The following procedure describes the single byte write operation:

- 1) The master sends a START condition
- 2) The master sends the 7-bit slave address plus a write bit (low)
- 3) The addressed slave asserts an ACK on the data line
- 4) The master sends the 8-bit register address
- 5) The slave asserts an ACK on the data line only if the address is valid (NAK if not)
- 6) The master sends 8 data bits
- 7) The slave asserts an ACK on the data line
- 8) The master generates a STOP condition

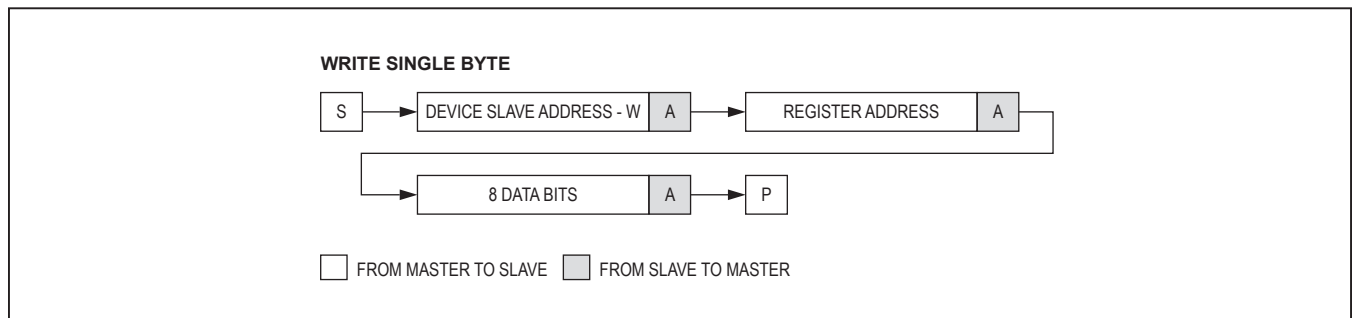

Figure 8. Write Byte Sequence



**Burst Write**

In this operation, the master sends an address and multiple data bytes to the slave device (Figure 9). The slave device automatically increments the register address after each data byte is sent. The following procedure describes the burst write operation:

- 1) The master sends a START condition.
- 2) The master sends the 7-bit slave address plus a write bit (low).
- 3) The addressed slave asserts an ACK on the data line.
- 4) The master sends the 8-bit register address.
- 5) The slave asserts an ACK on the data line only if the address is valid (NAK if not).
- 6) The master sends eight data bits.
- 7) The slave asserts an ACK on the data line.
- 8) Repeat 6 and 7 N-1 times.
- 9) The master generates a STOP condition.

**Single-Byte Read**

In this operation, the master sends an address plus two data bytes and receives one data byte from the slave device (Figure 10). The following procedure describes the single byte read operation:

- 1) The master sends a START condition.
- 2) The master sends the 7-bit slave address plus a write bit (low).
- 3) The addressed slave asserts an ACK on the data line.
- 4) The master sends the 8-bit register address.
- 5) The slave asserts an ACK on the data line only if the address is valid (NAK if not).
- 6) The master sends a REPEATED START condition.
- 7) The master sends the 7-bit slave address plus a read bit (high).
- 8) The addressed slave asserts an ACK on the data line.
- 9) The slave sends eight data bits.
- 10) The master asserts a NACK on the data line.
- 11) The master generates a STOP condition.

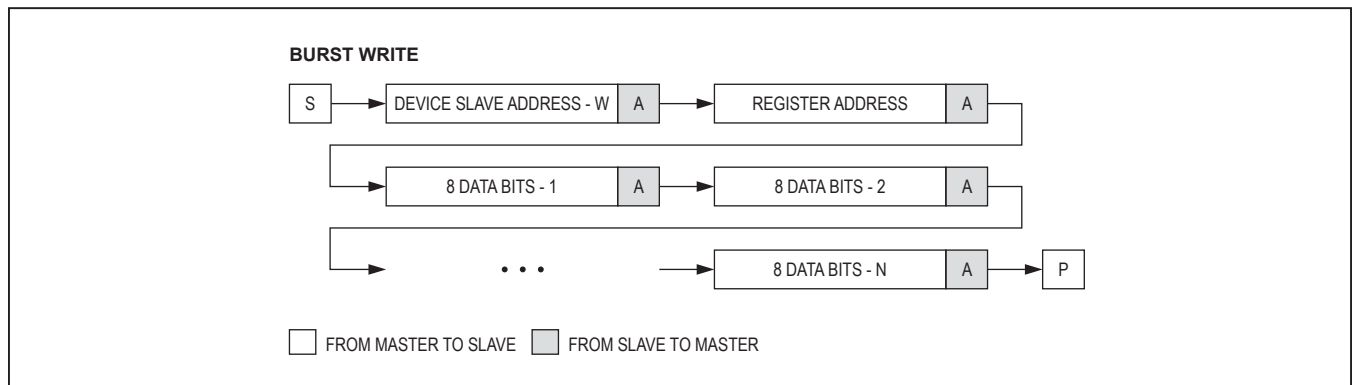

Figure 9. Burst Write Sequence

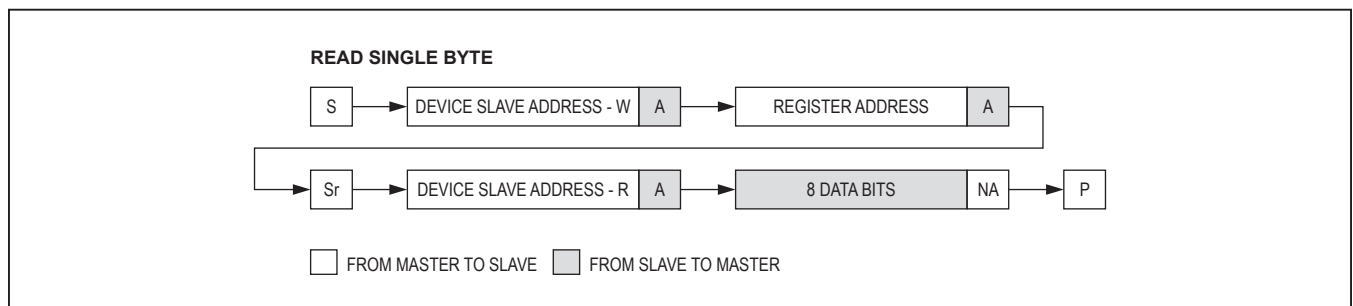

Figure 10. Read Byte Sequence

**Burst Read**

In this operation, the master sends an address plus two data bytes and receives multiple data bytes from the slave device (Figure 11). The following procedure describes the burst byte read operation:

- 1) The master sends a START condition.
- 2) The master sends the 7-bit slave address plus a write bit (low).
- 3) The addressed slave asserts an ACK on the data line.
- 4) The master sends the 8-bit register address.
- 5) The slave asserts an ACK on the data line only if the address is valid (NAK if not).
- 6) The master sends a REPEATED START condition.
- 7) The master sends the 7-bit slave address plus a read bit (high).
- 8) The slave asserts an ACK on the data line.

- 9) The slave sends eight data bits.
- 10) The master asserts an ACK on the data line.
- 11) Repeat 9 and 10 N-2 times.
- 12) The slave sends the last eight data bits.
- 13) The master asserts a NACK on the data line.
- 14) The master generates a STOP condition.

**Acknowledge Bits**

Data transfers are acknowledged with an acknowledge bit (ACK) or a not-acknowledge bit (NACK). Both the master and the MAX14748 generate ACK bits. To generate an ACK, pull SDA low before the rising edge of the ninth clock pulse and hold it low during the high period of the ninth clock pulse (see Figure 12). To generate a NACK, leave SDA high before the rising edge of the ninth clock pulse and leave it high for the duration of the ninth clock pulse. Monitoring for NACK bits allows for detection of unsuccessful data transfers.

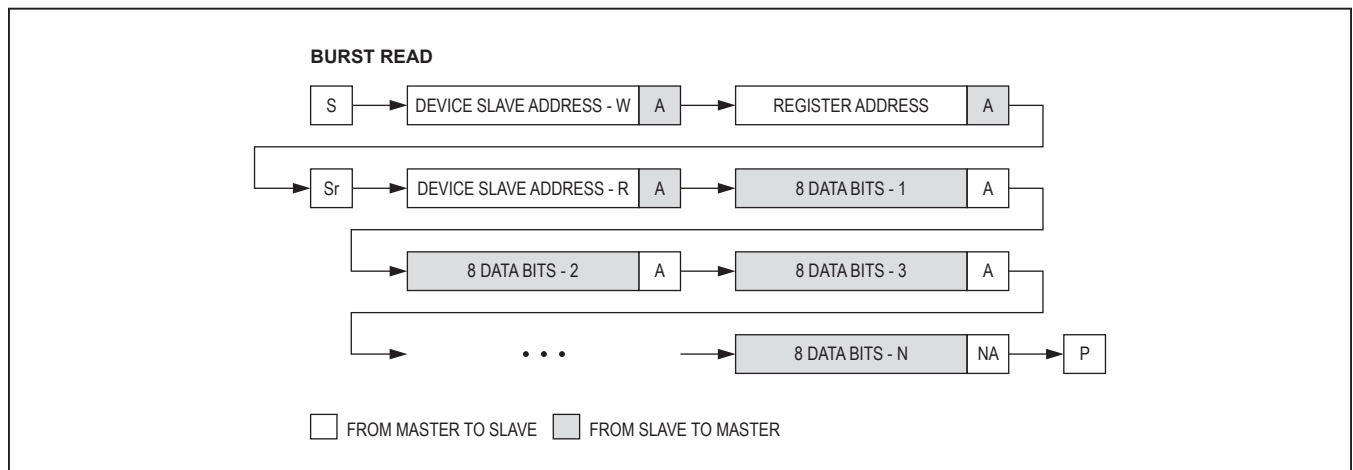

Figure 11. Burst Read Sequence

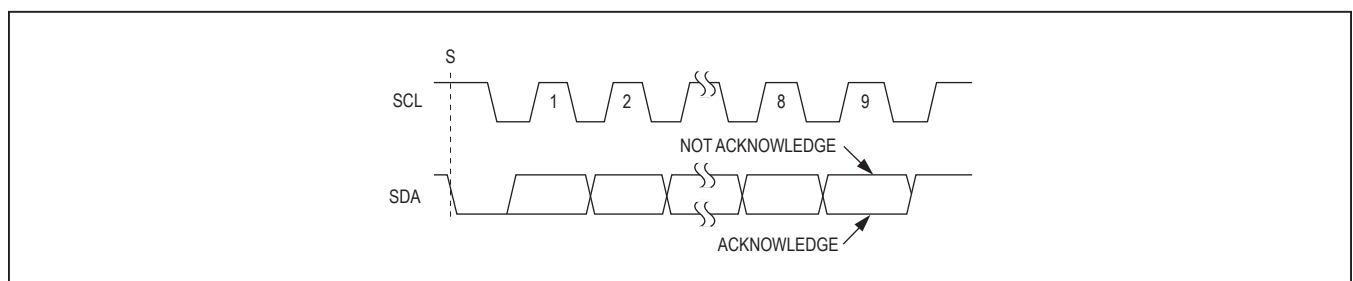

Figure 12. Acknowledge

Table 3. I<sup>2</sup>C Register Map

| REGISTER ADDRESS | REGISTER NAME | R/W   | B7              | B6            | B5                      | B4              | B3              | B2               | B1            | B0            |
|------------------|---------------|-------|-----------------|---------------|-------------------------|-----------------|-----------------|------------------|---------------|---------------|
| 0x00             | ChipID        | R     | ChipID[7:0]     |               |                         |                 |                 |                  |               |               |
| 0x01             | ChipRev       | R     | ChipRevH[3:0]   |               |                         |                 |                 |                  |               |               |
| 0x02             | DevStatus1    | R     | SysFlt          | ChgInOVP      | ILim                    | VSysReg         | ThrmSd150       | ThrmSd120        | BatDet        | WbChg         |
| 0x03             | AICLStatus    | R     | AICLStatus[2:0] |               |                         |                 |                 |                  |               |               |
| 0x04             | DevStatus2    | R     | -               | BattPREQB     | -                       | BypUVLO         | SysUVLOB        | DCDCILim         | DCDCRunAway   | DCDCPGood     |
| 0x05             | ChgStatus     | R     | DirChgFault     | -             | LowPow                  | -               | -               | ChgStat[3:0]     |               |               |
| 0x06             | JEITASStatus  | R     | -               | -             | -                       | ChgThrmRegCur   | ChgThrmRegVlt   | ChgThrmStat[2:0] |               |               |
| 0x07             | BCStatus      | R     | VBUSDet         | ChgTypRun     | -                       | PrChgTyp[2:0]   | -               | DCDTrmo          | ChgTyp[1:0]   | -             |
| 0x08             | Reserved      | R     | -               | -             | -                       | -               | -               | -                | -             | -             |
| 0x09             | CCStatus1     | R     | CCPinStat[1:0]  |               |                         |                 |                 |                  |               |               |
| 0x0A             | CCStatus2     | R     | -               | -             | -                       | -               | CCVcnStat       | CCStat[2:0]      | -             | -             |
| 0x0B             | DevInt1       | COR   | SysFlt          | ChgInOVPI     | ILim                    | VSysRegI        | ThrmSd150I      | ThrmSd120I       | BatDetI       | WbChgI        |
| 0x0C             | AICLInt       | COR   | -               | AICLI         | -                       | -               | -               | -                | -             | -             |
| 0x0D             | DevInt2       | COR   | -               | BattPREQI     | -                       | BypUVLOI        | SysUVLOI        | -                | -             | DCDCPGoodI    |
| 0x0E             | ChgInt        | COR   | DirChgFaultI    | LowPowRI      | LowPowFI                | -               | -               | -                | -             | ChgStatI      |
| 0x0F             | JEITAIInt     | COR   | -               | -             | -                       | ChgThrmRegCurl  | ChgThrmRegVltI  | -                | -             | ChgThrmStatI  |
| 0x10             | BCInt         | COR   | VBUSDetI        | -             | -                       | ChgTypRunFI     | ChgTypRunRI     | PrChgTypI        | DCDTrmol      | ChgTypI       |
| 0x11             | CCInt         | COR   | -               | VSAFE0VI      | DetAbrtI                | -               | CCPinStatI      | CCStatI          | CCVcnStatI    | CCStatI       |
| 0x12             | DevInt1Mask   | R/W   | SysFltIM        | ChgInOVPIM    | ILimIM                  | VSysRegIM       | ThrmSd150IM     | ThrmSd120IM      | BatDetIM      | WbChgIM       |
| 0x13             | AICLIntMask   | R/W   | -               | AICLIM        | -                       | -               | -               | -                | -             | -             |
| 0x14             | DevInt2Mask   | R/W   | -               | BattPREQIM    | -                       | BypUVLOIM       | SysUVLOIM       | DCDCILimIM       | DCDCRunAwayIM | DCDCPGoodIM   |
| 0x15             | ChgIntMask    | R/W   | DirChgFaultIM   | LowPowRIM     | LowPowFIM               | -               | -               | -                | -             | ChgStatIM     |
| 0x16             | JEITAIIntMask | R/W   | -               | -             | -                       | ChgThrmRegCurlM | ChgThrmRegVltIM | -                | -             | ChgThrmStatIM |
| 0x17             | BCIntMask     | R/W   | VBUSDetIM       | -             | -                       | ChgTypRunFIM    | ChgTypRunRIM    | PrChgTypIM       | DCDTrmolIM    | ChgTypIM      |
| 0x18             | CCIntMask     | R/W   | -               | VSAFE0VIM     | DetAbrtIM               | -               | CCPinStatIM     | CCStatIM         | CCVcnStatIM   | CCStatIM      |
| 0x19             | LED_CTRL      | R/W   | -               | -             | -                       | -               | -               | LEDCtrl          | LEDManual     | -             |
| 0x1A             | ThermaCfg1    | R/W   | T1T2IFchg[2:0]  |               |                         |                 |                 |                  |               |               |
| 0x1B             | ThermaCfg2    | R/W   | T3T4IFchg[2:0]  |               |                         |                 |                 |                  |               |               |
| 0x1C             | ThermaCfg3    | R/W   | -               | -             | -                       | -               | T3T4ENset       | T1T2ENset        | T3T4VFset     | T1T2VFset     |
| 0x1D             | ChargerCtrl1  | R/W** | ChgAutoStp      | BatReChg[1:0] | FreshBatDis (MAX14748B) | -               | -               | BatReg[1:0]      | ChgEn         | -             |
| 0x1E             | ChargerCtrl2  | R/W** | -               | VPchg[2:0]    | IPChg[1:0]              | -               | -               | ChgDone[1:0]     | -             | -             |

**Table 3. I<sup>2</sup>C Register Map (continued)**

| REGISTER ADDRESS | REGISTER NAME | R/W   | B7             | B6                | B5            | B4          | B3             | B2              | B1             | B0             |  |
|------------------|---------------|-------|----------------|-------------------|---------------|-------------|----------------|-----------------|----------------|----------------|--|
| 0x1F             | ChargerCtrl3  | R/W** | -              | ChgAutoSta        | MtChgTmr[1:0] | -           | FChgTmr[1:0]   | WeakBatEn       | PCChgTmr[1:0]  | -              |  |
| 0x20             | ChargerCtrl4  | R/W** | -              | WeakBatStat[2:0]* | -             | -           | -              | WeakBatEn       | -              | -              |  |
| 0x21             | CurLimCtrl    | R/W   | CurLim1Frc     | FSUSMsk           | -             | -           | -              | CurLim1Set[4:0] | -              | -              |  |
| 0x22             | CurLimStatus  | R     | -              | CurLim2Rb[2:0]    | -             | -           | -              | SpvChgLim[4:0]  | -              | -              |  |
| 0x23             | BBCFG1        | R/W** | -              | BoostRComp[3:0]   |               |             | -              | -               | -              | -              |  |
| 0x24             | BBCFG2        | R/W** | -              | -                 | -             | BBFrcZX     | -              | BuckVSet[3:0]   | -              | -              |  |
| 0x25             | BCCtrl1       | R/W   | DChg2s         | SFOutLvl          | -             | ADC3PDet    | SFOutCtrl[1:0] | ChgDetMan       | ChgDetEn       | -              |  |
| 0x26             | Reserved      | R     | -              | -                 | -             | -           | -              | -               | -              | -              |  |
| 0x27             | CCCtrl1       | R/W   | -              | -                 | -             | CCSrcSnk    | CCSrcSnk       | CCDbgEn         | CCAudEn        | CCDetEn        |  |
| 0x28             | CCCtrl2       | R/W   | CCForceError   | SnkAttached Lock  | CCSrcSnkSwp   | CCSrcSnkSwp | CCVcnSwp       | CCVcnEn         | CCSrcRst       | CCSnkRst       |  |
| 0x29             | CCCtrl3       | R/W   | -              | -                 | -             | -           | CCTrySnk       | CCPreferSnk     | CCDRPPPhase[1] | CCDRPPPhase[0] |  |
| 0x2A             | CHGINLim1     | R     | -              | -                 | -             | -           | CHGINLim[6:0]  |                 |                |                |  |
| 0x2B             | CHGINLim2     | R/W   | -              | -                 | -             | -           | CHGINLimGate   | SDPMaxCur[1:0]  | CDPMaxCur      | -              |  |
| 0x2C             | AICLCFG1      | R/W   | AICLEn         | -                 | -             | -           | -              | -               | -              | AICLAbort      |  |
| 0x2D             | AICLCFG2      | R/W   | BYPUVLO[2:0]   |                   |               | -           | -              | AICLMax[4:0]    |                |                |  |
| 0x2E             | AICLCFG3      | R/W   | -              | -                 | -             | BYPDeb      | AICLTBlk[1:0]  | -               | AICLTStep[1:0] | -              |  |
| 0x2F             | DPDNSw        | R/W   | -              | -                 | -             | -           | -              | -               | AnSwCtrl[1:0]  | -              |  |
| 0x30             | Others        | R/W   | -              | -                 | -             | -           | -              | -               | -              | USBCRset       |  |
| 0x31             | Reserved      | R     | -              | -                 | -             | -           | -              | -               | -              | -              |  |
| 0x32             | Reserved      | R     | -              | -                 | -             | -           | -              | -               | -              | -              |  |
| 0x33             | LowPow        | R/W   | LowPowEn       | -                 | -             | -           | -              | -               | -              | LowPowAbort    |  |
| 0x34             | Reserved      | R     | -              | -                 | -             | -           | -              | -               | -              | -              |  |
| 0x35             | FLTSEL        | R/W   | FLTSelect[1:0] |                   |               | -           | -              | -               | -              | -              |  |

**Note :** COR = Clear-on-read

\* Read Only

\*\* Read Only if WriteProtect is enabled (See Table 61).

- Reserved bits must not be modified from their default states to ensure proper operation.

## I<sup>2</sup>C Register Descriptions

### Table 4. ChipID Register (0x00)

|                    |  |   |   |   |   |   |   |   |
|--------------------|--|---|---|---|---|---|---|---|
| <b>ADDRESS:</b>    | 0x00   |   |   |   |   |   |   |   |
| <b>MODE:</b>       | Read Only  |   |   |   |   |   |   |   |
| <b>BIT</b>         | 7  | 6 | 5 | 4 | 3 | 2 | 1 | 0 |
| <b>NAME</b>        | ChipId[7:0]  |   |   |   |   |   |   |   |
| <b>ChipId[7:0]</b> | ChipId[7:0] bits show information about the version of the MAX14748. |   |   |   |   |   |   |   |

### Table 5. ChipRev Register (0x01)

|                      |   |   |   |   |               |   |   |   |
|----------------------|---|---|---|---|---------------|---|---|---|
| <b>ADDRESS:</b>      | 0x01  |   |   |   |               |   |   |   |
| <b>MODE:</b>         | Read Only   |   |   |   |               |   |   |   |
| <b>BIT</b>           | 7   | 6 | 5 | 4 | 3             | 2 | 1 | 0 |
| <b>NAME</b>          | ChipRevH[3:0]   |   |   |   | ChipRevL[3:0] |   |   |   |
| <b>ChipRevH[3:0]</b> | ChipRevH[3:0] bits show information about the revision of the MAX14748 silicon. |   |   |   |               |   |   |   |
| <b>ChipRevL[3:0]</b> | ChipRevL[3:0] bits show information about the revision of the MAX14748 silicon. |   |   |   |               |   |   |   |

### Table 6. DevStatus1 Register (0x02)

|                  |   |          |      |         |           |           |        |       |
|------------------|---|----------|------|---------|-----------|-----------|--------|-------|
| <b>ADDRESS:</b>  | 0x02  |          |      |         |           |           |        |       |
| <b>MODE:</b>     | Read Only   |          |      |         |           |           |        |       |
| <b>BIT</b>       | 7   | 6        | 5    | 4       | 3         | 2         | 1      | 0     |
| <b>NAME</b>      | SysFit  | ChgInOVP | ILim | VSysReg | ThrmSd150 | ThrmSd120 | BatDet | WbChg |
| <b>SysFit</b>    | System Fault<br>0 = System voltage is normal<br>1 = SYS voltage below SYS UVLO Threshold and the condition latched.   |          |      |         |           |           |        |       |
| <b>ChgInOVP</b>  | CHGIN Overvoltage Protection Flag<br>0 = CHGIN OVP not active<br>1 = CHGIN OVP active   |          |      |         |           |           |        |       |
| <b>ILim</b>      | Input Current Limiting<br>0 = CHGIN input current within limit<br>1 = CHGIN input in current limit  |          |      |         |           |           |        |       |
| <b>VSysReg</b>   | SYS Regulation (SYSOK)<br>0 = SYS voltage above SYS UVLO threshold and boost regulating SYS<br>1 = SYS voltage below SYS UVLO threshold or Boost not regulating SYS |          |      |         |           |           |        |       |
| <b>ThrmSd150</b> | Thermal shutdown<br>0 = Device in normal operation Mode<br>1 = Device in thermal shutdown ( $T_{DIE} > 150^{\circ}\text{C}$ )                                       |          |      |         |           |           |        |       |
| <b>ThrmSd120</b> | Thermal Warm<br>0 = Device in normal operation Mode<br>1 = $120^{\circ}\text{C} < T_{DIE} < 150^{\circ}\text{C}$  |          |      |         |           |           |        |       |
| <b>BatDet</b>    | Status of Battery Detection<br>0 = No battery detected<br>1 = Battery detected  |          |      |         |           |           |        |       |
| <b>WbChg</b>     | Weak Battery Charging<br>0 = Weak Battery Charge Timer expired or not running<br>1 = Weak Battery Charge Timer running  |          |      |         |           |           |        |       |

**Table 7. AICLStatus Register (0x03)**

|                        |   |          |          |          |                 |          |          |          |
|------------------------|---|----------|----------|----------|-----------------|----------|----------|----------|
| <b>ADDRESS:</b>        | <b>0x03</b>   |          |          |          |                 |          |          |          |
| <b>MODE:</b>           | <b>Read Only</b>  |          |          |          |                 |          |          |          |
| <b>BIT</b>             | <b>7</b>  | <b>6</b> | <b>5</b> | <b>4</b> | <b>3</b>        | <b>2</b> | <b>1</b> | <b>0</b> |
| <b>NAME</b>            | AICLStatus[2:0]   |          |          |          | AICLCurSet[4:0] |          |          |          |
| <b>AICLStatus[2:0]</b> | AICL Status<br>000 = AICL Off<br>001 = AICL Precheck<br>010 = AICL Increment<br>011 = AICL Blank<br>100 = AICL Idle<br>101 = AICL No Connection |          |          |          |                 |          |          |          |
| <b>AICLCurSet[4:0]</b> | Current limit set by AICL (if active)<br>0 = 100mA<br>1 = 200mA<br>...<br>30 = 3.1A<br>31 = 3.2A  |          |          |          |                 |          |          |          |

**Table 8. DevStatus2 Register (0x04)**

|                    |  |           |          |          |          |          |             |           |
|--------------------|--|-----------|----------|----------|----------|----------|-------------|-----------|
| <b>ADDRESS:</b>    | <b>0x04</b>  |           |          |          |          |          |             |           |
| <b>MODE:</b>       | <b>Read Only</b>   |           |          |          |          |          |             |           |
| <b>BIT</b>         | <b>7</b>   | <b>6</b>  | <b>5</b> | <b>4</b> | <b>3</b> | <b>2</b> | <b>1</b>    | <b>0</b>  |
| <b>NAME</b>        | –  | BattPREQB | –        | BypUVLO  | SysUVLOB | DCDCILim | DCDCRunAway | DCDCPGood |
| <b>BattPREQB</b>   | $V_{BAT}$ vs. $V_{PCHG}$ ( $V_{PCHG}$ programmable from 5.7V to 6.4V, BattPreqB status is NOT valid while the Weak Battery 2min timer is running.)<br>0 = $V_{BAT}$ below $V_{PCHG}$ threshold<br>1 = $V_{BAT}$ above $V_{PCHG}$ threshold |           |          |          |          |          |             |           |
| <b>BypUVLO</b>     | $V_{BYP}$ vs. $V_{BYPUVLO}$ ( $V_{BYPUVLO}$ programmable from 3.8V to 4.5V)<br>0 = $V_{BYP}$ above $V_{BYPUVLO}$ threshold<br>1 = $V_{BYP}$ below $V_{BYPUVLO}$ threshold  |           |          |          |          |          |             |           |
| <b>SysUVLOB</b>    | $V_{SYS}$ vs. $V_{SYSUVLO}$ ( $V_{SYSUVLO}$ programmable from 6.1V to 6.8V, SysUVLOB status is only valid in boost mode with CHGIN present)<br>0 = $V_{SYS}$ below $V_{SYSUVLO}$ threshold<br>1 = $V_{SYS}$ above $V_{SYSUVLO}$ threshold  |           |          |          |          |          |             |           |
| <b>DCDCILim</b>    | Reverse Buck Converter Current Limit Status<br>0 = Normal Operation<br>1 = Buck current limit has been reached   |           |          |          |          |          |             |           |
| <b>DCDCRunAway</b> | Reverse Buck Converter Runaway Status<br>0 = Normal Operation<br>1 = Buck runaway is asserted  |           |          |          |          |          |             |           |
| <b>DCDCPGood</b>   | Reverse Buck Converter Regulation Status<br>0 = Buck regulated value below 82% of the target value<br>1 = Normal operation   |           |          |          |          |          |             |           |

**Table 9. ChgStatus Register (0x05)**

| ADDRESS:            | 0x05   |   |        |   |              |   |   |   |
|---------------------|--|---|--------|---|--------------|---|---|---|
| MODE:               | Read Only  |   |        |   |              |   |   |   |
| BIT                 | 7  | 6 | 5      | 4 | 3            | 2 | 1 | 0 |
| NAME                | DirChgFault  | - | LowPow | - | ChgStat[3:0] |   |   |   |
| <b>DirChgFault</b>  | Direct charging fault<br>0 = Device in normal operation<br>1 = V <sub>BAT</sub> drops below V <sub>PCHG</sub> when battery is in supplement mode.  |   |        |   |              |   |   |   |
| <b>LowPow</b>       | Low Power Mode<br>0 = Not In Low Power Mode<br>1 = In Low Power Mode   |   |        |   |              |   |   |   |
| <b>ChgStat[3:0]</b> | Status of Charger Mode<br>0000 = Charger off<br>0001 = Charging suspended due to temperature (see state diagram)<br>0010 = Pre-charge in progress<br>0011 = Fast-charge, constant current mode in progress<br>0100 = Fast-charge, constant voltage mode in progress<br>0101 = Maintain charge in progress<br>0110 = Maintain charge done<br>0111 = Charger fault condition (see state diagram)<br>1000 = Battery Fault Suspend (see state diagram) |   |        |   |              |   |   |   |

**Table 10. JEITAStatus Register (0x06)**

| ADDRESS:                | 0x06   |   |   |               |               |                  |   |   |
|-------------------------|--|---|---|---------------|---------------|------------------|---|---|
| MODE:                   | Read Only  |   |   |               |               |                  |   |   |
| BIT                     | 7  | 6 | 5 | 4             | 3             | 2                | 1 | 0 |
| NAME                    | -  | - | - | ChgThrmRegCur | ChgThrmRegVlt | ChgThrmStat[2:0] |   |   |
| <b>ChgThrmRegCur</b>    | FastCharge Current reduced due to JEITA status<br>0 = Not changed<br>1 = Reduced   |   |   |               |               |                  |   |   |
| <b>ChgThrmRegVlt</b>    | Battery Regulation Voltage reduced due to JEITA status<br>0 = Not Changed<br>1 = Reduced   |   |   |               |               |                  |   |   |
| <b>ChgThrmStat[2:0]</b> | Thermistor Monitor<br>000 = T < T <sub>1</sub><br>001 = T <sub>1</sub> < T < T <sub>2</sub><br>010 = T <sub>2</sub> < T < T <sub>3</sub><br>011 = T <sub>3</sub> < T < T <sub>4</sub><br>100 = T > T <sub>4</sub><br>101 = No thermistor detected (THM high due to external pullup). Note: If a parallel resistor is used for thermistor monitoring, this mode may not function properly.<br>110 = NTC input disabled through ThermEn.<br>111 = Detection disabled due to CHGIN not present. |   |   |               |               |                  |   |   |

**Table 11. BCStatus Register (0x07)**

|                      |   |           |               |          |          |          |             |          |
|----------------------|---|-----------|---------------|----------|----------|----------|-------------|----------|
| <b>ADDRESS:</b>      | <b>0x09</b>   |           |               |          |          |          |             |          |
| <b>MODE:</b>         | <b>Read Only</b>  |           |               |          |          |          |             |          |
| <b>BIT</b>           | <b>7</b>  | <b>6</b>  | <b>5</b>      | <b>4</b> | <b>3</b> | <b>2</b> | <b>1</b>    | <b>0</b> |
| <b>NAME</b>          | VBUSDet   | ChgTypRun | PrChgTyp[2:0] |          |          | DCDTmo   | ChgTyp[1:0] |          |
| <b>VBUSDet</b>       | Status of CHGIN Detection<br>0 = VCHGIN < VBDET<br>1 = VCHGIN > VBDET   |           |               |          |          |          |             |          |
| <b>ChgTypRun</b>     | Charger Detection Running Status<br>0 = Not Running<br>1 = Running  |           |               |          |          |          |             |          |
| <b>PrChgTyp[2:0]</b> | Output of Proprietary Charger Detection<br>000 = Unknown<br>001 = Samsung 2A<br>010 = Apple 0.5A<br>011 = Apple 1A<br>100 = Apple 2A<br>101 = Apple 12W<br>110 = 3A DCP (If enabled)<br>111 = RFU   |           |               |          |          |          |             |          |
| <b>DCDTmo</b>        | DCD Time Out. DCD detection timed out during charger detection, indicating D+/D- are open. BC1.2 detection continues as required by BC1.2, but SDP most likely is found.<br>0 = No Timeout or detection not run<br>1 = DCD Timeout occurred |           |               |          |          |          |             |          |
| <b>ChgTyp[1:0]</b>   | Output of Charger Detection<br>00 = Nothing attached<br>01 = SDP, USB Cable attached<br>10 = CDP, Charging Downstream Port (current depends on USB operating speed)<br>11 = DCP, Dedicated Charger (current up to 1.5A)                     |           |               |          |          |          |             |          |

**Table 12. Reserved Register (0x08)**

|                 |                  |          |          |          |          |          |          |          |
|-----------------|------------------|----------|----------|----------|----------|----------|----------|----------|
| <b>ADDRESS:</b> | <b>0x08</b>      |          |          |          |          |          |          |          |
| <b>MODE:</b>    | <b>Read Only</b> |          |          |          |          |          |          |          |
| <b>BIT</b>      | <b>7</b>         | <b>6</b> | <b>5</b> | <b>4</b> | <b>3</b> | <b>2</b> | <b>1</b> | <b>0</b> |
| <b>NAME</b>     | -                | -        | -        | -        | -        | -        | -        | -        |



**Table 13. CCStatus1 Register (0x09)**

|                       |   |          |          |          |           |             |          |          |
|-----------------------|---|----------|----------|----------|-----------|-------------|----------|----------|
| <b>ADDRESS:</b>       | <b>0x09</b>   |          |          |          |           |             |          |          |
| <b>MODE:</b>          | <b>Read Only</b>  |          |          |          |           |             |          |          |
| <b>BIT</b>            | <b>7</b>  | <b>6</b> | <b>5</b> | <b>4</b> | <b>3</b>  | <b>2</b>    | <b>1</b> | <b>0</b> |
| <b>NAME</b>           | CCPinStat[1:0]  |          | CCISat   |          | CCVcnStat | CCStat[2:0] |          |          |
| <b>CCPinStat[1:0]</b> | Status of Active CC Pin<br>00 = No Determination<br>01 = CC1 Active<br>10 = CC2 Active<br>11 = RFU  |          |          |          |           |             |          |          |
| <b>CCISat</b>         | CC Pin Detected Allowed VBUS Current in UFP mode<br>00 = Not in UFP mode<br>01 = 500mA<br>10 = 1.5A<br>11 = 3.0A  |          |          |          |           |             |          |          |
| <b>CCVcnStat</b>      | Status of VCONN Output<br>0 = VCONN Disabled<br>1 = VCONN Enabled   |          |          |          |           |             |          |          |
| <b>CCStat[2:0]</b>    | Output of CC Pin Detection State Machine<br>000 = No Connection<br>001 = UFP<br>010 = DFP<br>011 = Audio Accessory<br>100 = Debug Accessory<br>101 = Error<br>110 = Disabled<br>111 = RFU |          |          |          |           |             |          |          |

**Table 14. CCStatus2 Register (0x0A)**

|                 |  |          |          |          |          |          |          |          |
|-----------------|--|----------|----------|----------|----------|----------|----------|----------|
| <b>ADDRESS:</b> | <b>0x0A</b>  |          |          |          |          |          |          |          |
| <b>MODE:</b>    | <b>Read Only</b>   |          |          |          |          |          |          |          |
| <b>BIT</b>      | <b>7</b>   | <b>6</b> | <b>5</b> | <b>4</b> | <b>3</b> | <b>2</b> | <b>1</b> | <b>0</b> |
| <b>NAME</b>     | -  | -        | -        | -        | VSAFE0V  | DetAbrt  | -        | -        |
| <b>VSAFE0V</b>  | Status of VBUS Detection. (Valid only in Attached.SRC_CCx, Attached.SNK_CCx state)<br>0 = V <sub>CHGIN</sub> < VSAFE0V<br>1 = V <sub>CHGIN</sub> > VSAFE0V   |          |          |          |          |          |          |          |
| <b>DetAbrt</b>  | Charger Detection Abort<br>0 = Charger Detection runs if ChgDetEn = 1 and VBUS is valid for the debounce time<br>1 = Charger Detection is aborted by Type-C State Machine. Charger detection will run if ChgDetEn = 1 and VBUS is valid for the debounce time. ChgDetMan bit allows manual run of charger detection. If Charger Detection is in progress, DetAbrt = 1 immediately stops the in-progress detection. |          |          |          |          |          |          |          |

**Table 15. DevInt1 Register (0x0B)**

| ADDRESS:          | 0x0B   |           |       |          |            |            |         |        |
|-------------------|--|-----------|-------|----------|------------|------------|---------|--------|
| MODE:             | Clear On Read  |           |       |          |            |            |         |        |
| BIT               | 7  | 6         | 5     | 4        | 3          | 2          | 1       | 0      |
| NAME              | SysFItI  | ChgInOVPI | ILimI | VSysRegI | ThrmSd150I | ThrmSd120I | BatDetI | WbChgI |
| <b>SysFItI</b>    | SysFit status change interrupt.<br>0 = Status of SysFit has NOT changed since the last time SysFItI was read<br>1 = Status of SysFit has changed since the last time SysFItI was read                |           |       |          |            |            |         |        |
| <b>ChgInOVPI</b>  | ChgInOVP status change interrupt.<br>0 = Status of ChgInOVP has NOT changed since the last time ChgInOVPI was read<br>1 = Status of ChgInOVP has changed since the last time ChgInOVPI was read      |           |       |          |            |            |         |        |
| <b>ILimI</b>      | ILim status change interrupt.<br>0 = Status of ILim has NOT changed since the last time ILimI was read<br>1 = Status of ILim has changed since the last time ILimI was read                          |           |       |          |            |            |         |        |
| <b>VSysRegI</b>   | VSysReg status change interrupt.<br>0 = Status of VSysReg has NOT changed since the last time VSysRegI was read<br>1 = Status of VSysReg has changed since the last time VSysRegI was read           |           |       |          |            |            |         |        |
| <b>ThrmSd150I</b> | ThrmSd150 status change interrupt.<br>0 = Status of ThrmSd150 has NOT changed since the last time ThrmSd150I was read<br>1 = Status of ThrmSd150 has changed since the last time ThrmSd150I was read |           |       |          |            |            |         |        |
| <b>ThrmSd120I</b> | ThrmSd120 status change interrupt.<br>0 = Status of ThrmSd120 has NOT changed since the last time ThrmSd120I was read<br>1 = Status of ThrmSd120 has changed since the last time ThrmSd120I was read |           |       |          |            |            |         |        |
| <b>BatDetI</b>    | BatDet status change interrupt.<br>0 = Status of BatDet has NOT changed since the last time BatDetI was read<br>1 = Status of BatDet has changed since the last time BatDetI was read                |           |       |          |            |            |         |        |
| <b>WbChgI</b>     | WbChg status change interrupt.<br>0 = Status of WbChg has NOT changed since the last time WbChgI was read<br>1 = Status of WbChg has changed since the last time WbChgI was read                     |           |       |          |            |            |         |        |

**Table 16. AICLIInt Register (0x0C)**

| ADDRESS:     | 0x0C  |       |   |   |   |   |   |   |
|--------------|---|-------|---|---|---|---|---|---|
| MODE:        | Clear On Read   |       |   |   |   |   |   |   |
| BIT          | 7   | 6     | 5 | 4 | 3 | 2 | 1 | 0 |
| NAME         | -   | AICLI | - | - | - | - | - | - |
| <b>AICLI</b> | AICLStatus status change interrupt.<br>0 = Status of AICLStatus has NOT changed since the last time AICLI was read<br>1 = Status of AICLStatus has changed since the last time AICLI was read |       |   |   |   |   |   |   |

Table 17. DevInt2 Register (0x0D)

| ADDRESS:            | 0x0D   |           |   |          |          |           |              |            |
|---------------------|--|-----------|---|----------|----------|-----------|--------------|------------|
| MODE:               | Clear On Read  |           |   |          |          |           |              |            |
| BIT                 | 7  | 6         | 5 | 4        | 3        | 2         | 1            | 0          |
| NAME                | –  | BattPREQI | – | BypUVLOI | SysUVLOI | DCDCILimI | DCDCRunAwayI | DCDCPGoodI |
| <b>BattPREQI</b>    | BattPREQ status change interrupt.<br>0 = Status of BattPREQ has NOT changed since the last time BattPREQI was read<br>1 = Status of BattPREQ has changed since the last time BattPREQI was read              |           |   |          |          |           |              |            |
| <b>BypUVLOI</b>     | BypUVLO status change interrupt.<br>0 = Status of BypUVLO has NOT changed since the last time BypUVLOI was read<br>1 = Status of BypUVLO has changed since the last time BypUVLOI was read                   |           |   |          |          |           |              |            |
| <b>SysUVLOI</b>     | SysUVLO status change interrupt.<br>0 = Status of SysUVLO has NOT changed since the last time SysUVLOI was read<br>1 = Status of SysUVLO has changed since the last time SysUVLOI was read                   |           |   |          |          |           |              |            |
| <b>DCDCILimI</b>    | DCDCILim status change interrupt.<br>0 = Status of DCDCILim has NOT changed since the last time DCDCILim was read<br>1 = Status of DCDCILim has changed since the last time DCDCILim was read                |           |   |          |          |           |              |            |
| <b>DCDCRunAwayI</b> | DCDCRunAway status change interrupt.<br>0 = Status of DCDCRunAway has NOT changed since the last time DCDCRunAway was read<br>1 = Status of DCDCRunAway has changed since the last time DCDCRunAway was read |           |   |          |          |           |              |            |
| <b>DCDCPGoodI</b>   | DCDCPGood status change interrupt.<br>0 = Status of DCDCPGood has NOT changed since the last time DCDCPGoodI was read<br>1 = Status of DCDCPGood has changed since the last time DCDCPGoodI was read         |           |   |          |          |           |              |            |

Table 18. ChgInt Register (0x0E)

| ADDRESS:            | 0x0E   |          |          |   |   |   |   |          |
|---------------------|--|----------|----------|---|---|---|---|----------|
| MODE:               | Clear On Read  |          |          |   |   |   |   |          |
| BIT                 | 7  | 6        | 5        | 4 | 3 | 2 | 1 | 0        |
| NAME                | DirChgFaultI   | LowPowRI | LowPowFI | - | - | - | - | ChgStatI |
| <b>DirChgFaultI</b> | DirChgFault status change interrupt.<br>0 = Status of DirChgFault has NOT changed since the last time DirChgFaultI was read<br>1 = Status of DirChgFault has changed since the last time DirChgFaultI was read |          |          |   |   |   |   |          |
| <b>LowPowRI</b>     | LowPow Rising Edge interrupt.<br>0 = LowPow bit rise edge has NOT occurred since the last time LowPowRI was read<br>1 = LowPow bit rise edge has occurred since the last time LowPowRI was read                |          |          |   |   |   |   |          |
| <b>LowPowFI</b>     | LowPow Falling Edge interrupt.<br>0 = LowPow bit falling edge has NOT occurred since the last time LowPowFI was read<br>1 = LowPow bit falling edge has occurred since the last time LowPowFI was read         |          |          |   |   |   |   |          |
| <b>ChgStatI</b>     | ChgStat[3:0] status change interrupt.<br>0 = Status of ChgStat[3:0] has NOT changed since the last time ChgStatI was read<br>1 = Status of ChgStat[3:0] has changed since the last time ChgStatI was read      |          |          |   |   |   |   |          |

**Table 19. JEITAInt Register (0x0F)**

| ADDRESS:              | 0x0F  |   |   |                |                |   |   |          |
|-----------------------|---|---|---|----------------|----------------|---|---|----------|
| MODE:                 | Clear On Read   |   |   |                |                |   |   |          |
| BIT                   | 7   | 6 | 5 | 4              | 3              | 2 | 1 | 0        |
| NAME                  | -   | - | - | ChgThrmRegCurl | ChgThrmRegVItl | - | - | ChgThrmI |
| <b>ChgThrmRegCurl</b> | ChgThrmRegCur status change interrupt.<br>0 = Status of ChgThrmRegCur has NOT changed since the last time ChgThrmRegCurl was read<br>1 = Status of ChgThrmRegCur has changed since the last time ChgThrmRegCurl was read      |   |   |                |                |   |   |          |
| <b>ChgThrmRegVItl</b> | ChgThrmRegVIt status change interrupt.<br>0 = Status of ChgThrmRegVIt has NOT changed since the last time ChgThrmRegVItl was read<br>1 = Status of ChgThrmRegVIt has changed since the last time ChgThrmRegVItl was read      |   |   |                |                |   |   |          |
| <b>ChgThrmStatI</b>   | ChgThrmStat[2:0] status change interrupt.<br>0 = Status of ChgThrmStat[2:0] has NOT changed since the last time ChgThrmStatI was read<br>1 = Status of ChgThrmStat[2:0] has changed since the last time ChgThrmStatI was read |   |   |                |                |   |   |          |

**Table 20. BCInt Register (0x10)**

| ADDRESS:           | 0x10  |   |   |             |             |           |         |         |
|--------------------|---|---|---|-------------|-------------|-----------|---------|---------|
| MODE:              | Clear On Read   |   |   |             |             |           |         |         |
| BIT                | 7   | 6 | 5 | 4           | 3           | 2         | 1       | 0       |
| NAME               | VBUSDetI  | - | - | ChgTypRunFI | ChgTypRunRI | PrChgTypI | DCDTmol | ChgTypI |
| <b>VBUSDetI</b>    | VBUSDet status change interrupt.<br>0 = Status of VBUSDet has NOT changed since the last time VBUSDetI was read<br>1 = Status of VBUSDet has changed since the last time VBUSDetI was read                            |   |   |             |             |           |         |         |
| <b>ChgTypRunFI</b> | ChgTypRun Falling Edge interrupt.<br>0 = ChgTypRun bit falling edge has NOT occurred since the last time ChgTypRunFI was read<br>1 = ChgTypRun bit falling edge has occurred since the last time ChgTypRunFI was read |   |   |             |             |           |         |         |
| <b>ChgTypRunRI</b> | ChgTypRun Rising Edge interrupt.<br>0 = ChgTypRun bit rising edge has NOT occurred since the last time ChgTypRunRI was read<br>1 = ChgTypRun bit rising edge has occurred since the last time ChgTypRunRI was read    |   |   |             |             |           |         |         |
| <b>PrChgTypI</b>   | PrChgTyp status change interrupt.<br>0 = Status of PrChgTyp has NOT changed since the last time PrChgTypI was read<br>1 = Status of PrChgTyp has changed since the last time PrChgTypI was read                       |   |   |             |             |           |         |         |
| <b>DCDTmol</b>     | DCDTmo status change interrupt.<br>0 = Status of DCDTmo has NOT changed since the last time DCDTmol was read<br>1 = Status of DCDTmo has changed since the last time DCDTmol was read                                 |   |   |             |             |           |         |         |
| <b>ChgTypI</b>     | ChgTyp status change interrupt.<br>0 = Status of ChgTyp has NOT changed since the last time ChgTypI was read<br>1 = Status of ChgTyp has changed since the last time ChgTypI was read                                 |   |   |             |             |           |         |         |

**Table 21. CCInt Register (0x11)**

|                   |  |          |          |          |            |          |            |          |
|-------------------|--|----------|----------|----------|------------|----------|------------|----------|
| <b>ADDRESS:</b>   | 0x11   |          |          |          |            |          |            |          |
| <b>MODE:</b>      | Clear On Read  |          |          |          |            |          |            |          |
| <b>BIT</b>        | <b>7</b>   | <b>6</b> | <b>5</b> | <b>4</b> | <b>3</b>   | <b>2</b> | <b>1</b>   | <b>0</b> |
| <b>NAME</b>       | -  | VSAFE0VI | DetAbtrl | -        | CCPinStatl | CCISatl  | CCVcnStatl | CCStatl  |
| <b>VSAFE0VI</b>   | VSAFE0V status change interrupt.<br>0 = Status of VSAFE0V has NOT changed since the last time VSAFE0VI was read<br>1 = Status of VSAFE0V has changed since the last time VSAFE0VI was read           |          |          |          |            |          |            |          |
| <b>DetAbtrl</b>   | DetAbtrl status change interrupt.<br>0 = Status of DetAbtrl has NOT changed since the last time DetAbtrl was read<br>1 = Status of DetAbtrl has changed since the last time DetAbtrl was read        |          |          |          |            |          |            |          |
| <b>CCPinStatl</b> | CCPinStat status change interrupt.<br>0 = Status of CCPinStat has NOT changed since the last time CCPinStatl was read<br>1 = Status of CCPinStat has changed since the last time CCPinStatl was read |          |          |          |            |          |            |          |
| <b>CCISatl</b>    | CCISatl status change interrupt.<br>0 = Status of CCISatl has NOT changed since the last time CCISatl was read<br>1 = Status of CCISatl has changed since the last time CCISatl was read             |          |          |          |            |          |            |          |
| <b>CCVcnStatl</b> | CCVcnStat status change interrupt.<br>0 = Status of CCVcnStat has NOT changed since the last time CCVcnStatl was read<br>1 = Status of CCVcnStat has changed since the last time CCVcnStatl was read |          |          |          |            |          |            |          |
| <b>CCStatl</b>    | CCStat status change interrupt.<br>0 = Status of CCStat has NOT changed since the last time CCStatl was read<br>1 = Status of CCStat has changed since the last time CCStatl was read                |          |          |          |            |          |            |          |

**Table 22. DevInt1Mask Register (0x12)**

|                    |   |           |          |           |             |             |          |          |
|--------------------|---|-----------|----------|-----------|-------------|-------------|----------|----------|
| <b>ADDRESS:</b>    | <b>0x12</b>   |           |          |           |             |             |          |          |
| <b>MODE:</b>       | <b>Read/Write</b>                                   |           |          |           |             |             |          |          |
| <b>BIT</b>         | <b>7</b>  | <b>6</b>  | <b>5</b> | <b>4</b>  | <b>3</b>    | <b>2</b>    | <b>1</b> | <b>0</b> |
| <b>NAME</b>        | SysFItIM  | ChgInOVPI | ILimIM   | VSysRegIM | ThrmSd150IM | ThrmSd120IM | BatDetIM | WbChgIM  |
| <b>SysFItIM</b>    | SysFItI Interrupt Mask<br>1 = Mask<br>0 = Unmask    |           |          |           |             |             |          |          |
| <b>ChgInOVPI</b>   | ChgInOVPI Interrupt Mask<br>1 = Mask<br>0 = Unmask  |           |          |           |             |             |          |          |
| <b>ILimIM</b>      | ILimI Interrupt Mask<br>1 = Mask<br>0 = Unmask      |           |          |           |             |             |          |          |
| <b>VSysRegIM</b>   | VSysRegI Interrupt Mask<br>1 = Mask<br>0 = Unmask   |           |          |           |             |             |          |          |
| <b>ThrmSd150IM</b> | ThrmSd150I Interrupt Mask<br>1 = Mask<br>0 = Unmask |           |          |           |             |             |          |          |
| <b>ThrmSd120IM</b> | ThrmSd120I Interrupt Mask<br>1 = Mask<br>0 = Unmask |           |          |           |             |             |          |          |
| <b>BatDetIM</b>    | BatDetI Interrupt Mask<br>1 = Mask<br>0 = Unmask    |           |          |           |             |             |          |          |
| <b>WbChgIM</b>     | WbChgI Interrupt Mask<br>1 = Mask<br>0 = Unmask     |           |          |           |             |             |          |          |

**Table 23. AICLIIntMask Register (0x13)**

|                 |  |          |          |          |          |          |          |          |
|-----------------|--|----------|----------|----------|----------|----------|----------|----------|
| <b>ADDRESS:</b> | <b>0x13</b>                                    |          |          |          |          |          |          |          |
| <b>MODE:</b>    | <b>Read/Write</b>                              |          |          |          |          |          |          |          |
| <b>BIT</b>      | <b>7</b>                                       | <b>6</b> | <b>5</b> | <b>4</b> | <b>3</b> | <b>2</b> | <b>1</b> | <b>0</b> |
| <b>NAME</b>     | -  | AICLIM   | -        | -        | -        | -        | -        | -        |
| <b>AICLIM</b>   | AICLI Interrupt Mask<br>1 = Mask<br>0 = Unmask |          |          |          |          |          |          |          |

**Table 24. DevInt2Mask Register (0x14)**

|                      |   |            |          |           |           |            |               |             |
|----------------------|---|------------|----------|-----------|-----------|------------|---------------|-------------|
| <b>ADDRESS:</b>      | 0x14  |            |          |           |           |            |               |             |
| <b>MODE:</b>         | Read/Write  |            |          |           |           |            |               |             |
| <b>BIT</b>           | <b>7</b>  | <b>6</b>   | <b>5</b> | <b>4</b>  | <b>3</b>  | <b>2</b>   | <b>1</b>      | <b>0</b>    |
| <b>NAME</b>          | -   | BattPREQIM | -        | BypUVLOIM | SysUVLOIM | DCDCILimIM | DCDCRunAwayIM | DCDCPGoodIM |
| <b>BattPREQIM</b>    | BattPREQI Interrupt Mask<br>1 = Mask<br>0 = Unmask    |            |          |           |           |            |               |             |
| <b>BypUVLOIM</b>     | BypUVLOI Interrupt Mask<br>1 = Mask<br>0 = Unmask     |            |          |           |           |            |               |             |
| <b>SysUVLOIM</b>     | SysUVLOI Interrupt Mask<br>1 = Mask<br>0 = Unmask     |            |          |           |           |            |               |             |
| <b>DCDCILimIM</b>    | DCDCILimI Interrupt Mask<br>1 = Mask<br>0 = Unmask    |            |          |           |           |            |               |             |
| <b>DCDCRunAwayIM</b> | DCDCRunAwayI Interrupt Mask<br>1 = Mask<br>0 = Unmask |            |          |           |           |            |               |             |
| <b>DCDCPGoodIM</b>   | DCDCPGoodI Interrupt Mask<br>1 = Mask<br>0 = Unmask   |            |          |           |           |            |               |             |

**Table 25. ChgIntMask Register (0x15)**

|                      |   |           |           |          |          |          |          |           |
|----------------------|---|-----------|-----------|----------|----------|----------|----------|-----------|
| <b>ADDRESS:</b>      | 0x15  |           |           |          |          |          |          |           |
| <b>MODE:</b>         | Read/Write  |           |           |          |          |          |          |           |
| <b>BIT</b>           | <b>7</b>  | <b>6</b>  | <b>5</b>  | <b>4</b> | <b>3</b> | <b>2</b> | <b>1</b> | <b>0</b>  |
| <b>NAME</b>          | DirChgFaultIM   | LowPowRIM | LowPowFIM | -        | -        | -        | -        | ChgStatIM |
| <b>DirChgFaultIM</b> | DirChgFaultI Interrupt Mask<br>1 = Mask<br>0 = Unmask |           |           |          |          |          |          |           |
| <b>LowPowRIM</b>     | LowPowRI Interrupt Mask<br>1 = Mask<br>0 = Unmask     |           |           |          |          |          |          |           |
| <b>LowPowFIM</b>     | LowPowFI Interrupt Mask<br>1 = Mask<br>0 = Unmask     |           |           |          |          |          |          |           |
| <b>ChgStatIM</b>     | ChgStatI Interrupt Mask<br>1 = Mask<br>0 = Unmask     |           |           |          |          |          |          |           |

**Table 26. JEITAIntMask Register (0x16)**

| ADDRESS:               | 0x16  |   |   |                 |                 |   |   |               |
|------------------------|---|---|---|-----------------|-----------------|---|---|---------------|
| MODE:                  | Read/Write  |   |   |                 |                 |   |   |               |
| BIT                    | 7   | 6 | 5 | 4               | 3               | 2 | 1 | 0             |
| NAME                   | -   | - | - | ChgThrmRegCurlM | ChgThrmRegVltIM | - | - | ChgThrmStatIM |
| <b>ChgThrmRegCurlM</b> | ChgThrmRegCurl Interrupt Mask<br>1 = Mask<br>0 = Unmask |   |   |                 |                 |   |   |               |
| <b>ChgThrmRegVltIM</b> | ChgThrmRegVI Interrupt Mask<br>1 = Mask<br>0 = Unmask   |   |   |                 |                 |   |   |               |
| <b>ChgThrmIM</b>       | ChgThrmI Interrupt Mask<br>1 = Mask<br>0 = Unmask       |   |   |                 |                 |   |   |               |

**Table 27. BCIntMask Register (0x17)**

| ADDRESS:            | 0x17   |   |   |              |              |            |          |          |
|---------------------|--|---|---|--------------|--------------|------------|----------|----------|
| MODE:               | Read/Write   |   |   |              |              |            |          |          |
| BIT                 | 7  | 6 | 5 | 4            | 3            | 2          | 1        | 0        |
| NAME                | VBUSDetIM  | - | - | ChgTypRunFIM | ChgTypRunRIM | PrChgTypIM | DCDTmoIM | ChgTypIM |
| <b>VBUSDetIM</b>    | VBUSDetI Interrupt Mask<br>1 = Mask<br>0 = Unmask    |   |   |              |              |            |          |          |
| <b>ChgTypRunFIM</b> | ChgTypRunFI Interrupt Mask<br>1 = Mask<br>0 = Unmask |   |   |              |              |            |          |          |
| <b>ChgTypRunRIM</b> | ChgTypRunRI Interrupt Mask<br>1 = Mask<br>0 = Unmask |   |   |              |              |            |          |          |
| <b>PrChgTypIM</b>   | PrChgTypI Interrupt Mask<br>1 = Mask<br>0 = Unmask   |   |   |              |              |            |          |          |
| <b>DCDTmoIM</b>     | DCDTmI Interrupt Mask<br>1 = Mask<br>0 = Unmask      |   |   |              |              |            |          |          |
| <b>ChgTypIM</b>     | ChgTypI Interrupt Mask<br>1 = Mask<br>0 = Unmask     |   |   |              |              |            |          |          |



**Table 28. CCIntMask Register (0x18)**

| ADDRESS:           | 0x18  |           |           |   |             |          |             |          |
|--------------------|---|-----------|-----------|---|-------------|----------|-------------|----------|
| MODE:              | Read/Write  |           |           |   |             |          |             |          |
| BIT                | 7   | 6         | 5         | 4 | 3           | 2        | 1           | 0        |
| NAME               | -   | VSAFE0VIM | DetAbtrlM | - | CCPinStatIM | CCISatIM | CCVcnStatIM | CCStatIM |
| <b>VSAFE0VIM</b>   | VSAFE0VI Interrupt Mask<br>1 = Mask<br>0 = Unmask   |           |           |   |             |          |             |          |
| <b>DetAbtrlM</b>   | DetAbtrl Interrupt Mask<br>1 = Mask<br>0 = Unmask   |           |           |   |             |          |             |          |
| <b>CCPinStatIM</b> | CCPinStatI Interrupt Mask<br>1 = Mask<br>0 = Unmask |           |           |   |             |          |             |          |
| <b>CCISatIM</b>    | CCISatI Interrupt Mask<br>1 = Mask<br>0 = Unmask    |           |           |   |             |          |             |          |
| <b>CCVcnStatIM</b> | CCVcnStatI Interrupt Mask<br>1 = Mask<br>0 = Unmask |           |           |   |             |          |             |          |
| <b>CCStatIM</b>    | CCStatI Interrupt Mask<br>1 = Mask<br>0 = Unmask    |           |           |   |             |          |             |          |

**Table 29. LED\_CTRL Register (0x19)**

| ADDRESS:         | 0x19  |   |   |   |   |   |         |           |
|------------------|---|---|---|---|---|---|---------|-----------|
| MODE:            | Read/Write  |   |   |   |   |   |         |           |
| BIT              | 7   | 6 | 5 | 4 | 3 | 2 | 1       | 0         |
| NAME             | -   | - | - | - | - | - | LEDCtrl | LEDManual |
| <b>LEDCtrl</b>   | LED Manual Control<br>0 = LED is OFF<br>1 = LED is ON   |   |   |   |   |   |         |           |
| <b>LEDManual</b> | LED Auto/Manual Configuration<br>0 = LED is controlled via charger state machine.<br>1 = LED output is manually controlled by LEDCntrl bit. |   |   |   |   |   |         |           |

**Table 30. ThermaCfg1 Register (0x1A)**

|                       |  |          |          |                |          |          |                |          |
|-----------------------|--|----------|----------|----------------|----------|----------|----------------|----------|
| <b>ADDRESS:</b>       | 0x1A   |          |          |                |          |          |                |          |
| <b>MODE:</b>          | Read/Write   |          |          |                |          |          |                |          |
| <b>BIT</b>            | <b>7</b>   | <b>6</b> | <b>5</b> | <b>4</b>       | <b>3</b> | <b>2</b> | <b>1</b>       | <b>0</b> |
| <b>NAME</b>           | T1T2IFchg[2:0]   |          |          | T2T3IFchg[2:0] |          |          | JeitaCfgR[1:0] |          |
| <b>T1T2IFchg[2:0]</b> | Fast Charge Current for T1-T2 temperature zone<br>000 = 0.2 x IFChg<br>001 = 0.3 x IFChg<br>010 = 0.4 x IFChg<br>011 = 0.5 x IFChg<br>100 = 0.6 x IFChg<br>101 = 0.7 x IFChg<br>110 = 0.8 x IFChg<br>111 = 1.0 x IFChg                                   |          |          |                |          |          |                |          |
| <b>T2T3IFchg[2:0]</b> | Fast Charge Current for T2-T3 temperature zone<br>000 = 0.2 x IFChg<br>001 = 0.3 x IFChg<br>010 = 0.4 x IFChg<br>011 = 0.5 x IFChg<br>100 = 0.6 x IFChg<br>101 = 0.7 x IFChg<br>110 = 0.8 x IFChg<br>111 = 1.0 x IFChg                                   |          |          |                |          |          |                |          |
| <b>JeitaCfgR[1:0]</b> | TPU SW Configuration<br>00 = JEITA Monitoring and TPU SW disabled<br>01 = JEITA Monitoring and TPU SW Enabled if $V_{CHGIN} > V_{BDET}$ (10ms Debounce)<br>10 = JEITA Monitoring and TPU SW Enabled<br>11 = JEITA Monitoring disabled and TPU SW enabled |          |          |                |          |          |                |          |

**Table 31. ThermaCfg2 Register (0x1B)**

|                       |  |   |   |   |           |           |           |           |
|-----------------------|--|---|---|---|-----------|-----------|-----------|-----------|
| <b>ADDRESS:</b>       | 0x1B   |   |   |   |           |           |           |           |
| <b>MODE:</b>          | Read/Write   |   |   |   |           |           |           |           |
| <b>BIT</b>            | 7  | 6 | 5 | 4 | 3         | 2         | 1         | 0         |
| <b>NAME</b>           | T3T4IFchg[2:0]   |   |   | - | T3T4ENset | T1T2ENset | T3T4VFset | T1T2VFset |
| <b>T3T4IFchg[2:0]</b> | Fast Charge Current for T3-T4 temperature zone<br>000 = 0.2 x IFChg<br>001 = 0.3 x IFChg<br>010 = 0.4 x IFChg<br>011 = 0.5 x IFChg<br>100 = 0.6 x IFChg<br>101 = 0.7 x IFChg<br>110 = 0.8 x IFChg<br>111 = 1.0 x IFChg |   |   |   |           |           |           |           |
| <b>T3T4ENset</b>      | JEITA charger On/Off in T3-T4 zone. (Only valid if JEITACtrSet = 1)<br>0 = JEITA turns charger off in T3-T4 zone<br>1 = JEITA doesn't turn charger off in T3-T4 zone   |   |   |   |           |           |           |           |
| <b>T1T2ENset</b>      | JEITA charger On/Off in T1-T2 zone. (Only valid if JEITACtrSet = 1)<br>0 = JEITA turns charger off in T1-T2 zone<br>1 = JEITA doesn't turn charger off in T1-T2 zone   |   |   |   |           |           |           |           |
| <b>T3T4VFset</b>      | JEITA voltage scaling enable in T3-T4. (Only valid if JEITACtrSet = 1)<br>1 = Enabled<br>0 = Disabled  |   |   |   |           |           |           |           |
| <b>T1T2VFset</b>      | JEITA voltage scaling enabled in T1-T2. (Only valid if JEITACtrSet = 1)<br>1 = Enabled<br>0 = Disabled   |   |   |   |           |           |           |           |

**Table 32. ThermaCfg3 Register (0x1C)**

|                    |  |   |   |   |   |   |             |             |
|--------------------|--|---|---|---|---|---|-------------|-------------|
| <b>ADDRESS:</b>    | 0x1C   |   |   |   |   |   |             |             |
| <b>MODE:</b>       | Read/Write Unless Otherwise Noted  |   |   |   |   |   |             |             |
| <b>BIT</b>         | 7  | 6 | 5 | 4 | 3 | 2 | 1           | 0           |
| <b>NAME</b>        | -  | - | - | - | - | - | JEITACtrSet | WarmCoolSel |
| <b>JEITACtrSet</b> | JEITA Control Enable<br>0 = JEITA status Not affect charger<br>1 = JEITA status affects charger settings (See register ThermaCfg2) |   |   |   |   |   |             |             |
| <b>WarmCoolSel</b> | Warm/Cool JEITA Zone Thresholds Select (Read Only).<br>0 = 45°C Warm, 10°C Cool<br>1 = 25°C Warm, 10°C Cool                        |   |   |   |   |   |             |             |

**Table 33. ChargerCtrl1 Register (0x1D)**

| ADDRESS:                           | 0x1D  |               |   |                            |   |             |   |       |
|------------------------------------|---|---------------|---|----------------------------|---|-------------|---|-------|
| MODE:                              | Read/Write or Read-Only if AppWrtPrct = "(1) Protected" (See Table 61)  |               |   |                            |   |             |   |       |
| BIT                                | 7   | 6             | 5 | 4                          | 3 | 2           | 1 | 0     |
| NAME                               | ChgAutoStp  | BatReChg[1:0] |   | FreshBatDis<br>(MAX14748B) | – | BatReg[1:0] |   | ChgEn |
| <b>ChgAutoStp</b>                  | Charger Auto-Stop. Controls the transition from maintain charge to maintain charge done. See <i>Battery Charger State</i> diagram.<br>0 = Auto-Stop disabled.<br>1 = Auto-Stop enabled. |               |   |                            |   |             |   |       |
| <b>BatReChg[1:0]</b>               | BAT Recharge Threshold. If ChgAutoSta = 1, charger restarts charging if $V_{BAT}$ falls below $V_{BATREG}$ by this amount.<br>00 = 200mV<br>01 = 300mV<br>10 = 400mV<br>11 = 500mV      |               |   |                            |   |             |   |       |
| <b>FreshBatDis<br/>(MAX14748B)</b> | Enable/Disable Fresh Battery Feature (See Fig 4)<br>0 = Fresh Battery Feature Enabled<br>1 = Fresh Battery Feature Disabled<br>Note, this bit should only be changed when ChgEn=0.      |               |   |                            |   |             |   |       |
| <b>BatReg[1:0]</b>                 | Battery Regulation Threshold<br>00 = 8.3V<br>01 = 8.4V<br>10 = 8.5V<br>11 = 8.6V  |               |   |                            |   |             |   |       |
| <b>ChgEn</b>                       | On/Off Control for Charger (does not impact SYS node).<br>0 = Charger disabled<br>1 = Charger enabled   |               |   |                            |   |             |   |       |

**Table 34. ChargerCtrl2 Register (0x1E)**

| ADDRESS:            | 0x1E   |            |   |   |            |   |              |   |
|---------------------|--|------------|---|---|------------|---|--------------|---|
| MODE:               | Read/Write or Read-Only if AppWrtPrct = "(1) Protected" (See Table 61)   |            |   |   |            |   |              |   |
| BIT                 | 7  | 6          | 5 | 4 | 3          | 2 | 1            | 0 |
| NAME                | -  | VPchg[2:0] |   |   | IPChg[1:0] |   | ChgDone[1:0] |   |
| <b>VPchg[2:0]</b>   | Pre-charge Voltage Threshold Setting<br>000 = 5.7V<br>001 = 5.8V<br>010 = 5.9V<br>111 = 6.0V<br>100 = 6.1V<br>101 = 6.2V<br>110 = 6.3V<br>111 = 6.4V |            |   |   |            |   |              |   |
| <b>IPChg[1:0]</b>   | Pre-charge Current Setting<br>00 = 0.05 x IFChg<br>01 = 0.1 x IFChg<br>10 = 0.2 x IFChg<br>11 = 0.3 x IFChg  |            |   |   |            |   |              |   |
| <b>ChgDone[1:0]</b> | Charge Done Threshold Setting<br>00 = 0.05 x IFChg<br>01 = 0.1 x IFChg<br>10 = 0.2 x IFChg<br>11 = Reserved  |            |   |   |            |   |              |   |

**Table 35. ChargerCtrl3 Register (0x1F)**

| ADDRESS:             | 0x1F  |            |               |   |              |   |              |   |
|----------------------|---|------------|---------------|---|--------------|---|--------------|---|
| MODE:                | Read/Write or Read-Only if AppWrtPrct = "(1) Protected" (See Table 61)  |            |               |   |              |   |              |   |
| BIT                  | 7   | 6          | 5             | 4 | 3            | 2 | 1            | 0 |
| NAME                 | -   | ChgAutoSta | MtChgTmr[1:0] |   | FChgTmr[1:0] |   | PChgTmr[1:0] |   |
| <b>ChgAutoSta</b>    | Charger Auto-Restart Control<br>0 = Charger remains in maintain charge done even when VBAT is less than BAT recharge threshold.<br>1 = Charger automatically restarts when VBAT drops below BAT recharge threshold. |            |               |   |              |   |              |   |
| <b>MtChgTmr[1:0]</b> | Maintain Charge Timer Setting<br>00 = 0min<br>01 = 15min<br>10 = 30min<br>11 = 60min  |            |               |   |              |   |              |   |
| <b>FChgTmr[1:0]</b>  | Fast- Charge Timer Setting<br>00 = 75min<br>01 = 150min<br>10 = 300min<br>11 = 600min   |            |               |   |              |   |              |   |
| <b>PChgTmr[1:0]</b>  | Pre-charge Timer Setting<br>00 = 30min<br>01 = 60min<br>10 = 120min<br>11 = 240min  |            |               |   |              |   |              |   |

**Table 36. ChargerCtrl4 Register (0x20)**

| ADDRESS:                | 0x20  |   |   |   |  |           |   |   |
|-------------------------|---|---|---|---|--|-----------|---|---|
| MODE:                   | Read-Only   |   |   |   | Read/Write or Read-Only if AppWrtPrct = "(1) Protected" (See Table 61) |           |   |   |
| BIT                     | 7   | 6 | 5 | 4 | 3  | 2         | 1 | 0 |
| NAME                    | WeakBatStat[2:0]  |   |   | - | -  | WeakBatEn | - | - |
| <b>WeakBatStat[2:0]</b> | Weak Battery FSM status<br>000 = Idle, charger is not SDP<br>001 = Battery condition check<br>010 = Weak Battery 2-minute counter running<br>011 = Good Battery.<br>100 = Weak Battery 2-minute counter expired<br>101-111 = Reserved |   |   |   |  |           |   |   |
| <b>WeakBatEna</b>       | Weak Battery FSM Enable<br>0 = Disable<br>1 = Enable  |   |   |   |  |           |   |   |

**Table 37. CurLimCtrl Register (0x21)**

| ADDRESS:               | 0x21   |         |   |                 |   |   |   |   |
|------------------------|--|---------|---|-----------------|---|---|---|---|
| MODE:                  | Read/Write   |         |   |                 |   |   |   |   |
| BIT                    | 7  | 6       | 5 | 4               | 3 | 2 | 1 | 0 |
| NAME                   | CurLim1Frc   | FSUSMsk | - | CurLim1Set[4:0] |   |   |   |   |
| <b>CurLim1Frc</b>      | Forced Input Current Limit Enable. When CurLim1Frc is 1, the input current limit is by the CurLim1Set[4:0].<br>0 = Not forced<br>1 = Forced  |         |   |                 |   |   |   |   |
| <b>FSUSMsk</b>         | FSUS pin function mask. If FSUSMsk is 1, FSUS pin status is ignored.<br>0 = FSUS pin function enabled<br>1 = FSUS pin function disabled  |         |   |                 |   |   |   |   |
| <b>CurLim1Set[4:0]</b> | Forced Input Current Limit Value. The input current limit is forced to this value if CurLim1Frc is set to 1.<br>00000 = 0.10A<br>00001 = 0.20A<br>...<br>11101 = 3.00A<br>11110 = Reserved<br>11111 = Reserved |         |   |                 |   |   |   |   |

**Table 38. CurLimStatus Register (0x22)**

| ADDRESS:               | 0x22  |   |   |   |                 |   |   |   |
|------------------------|---|---|---|---|-----------------|---|---|---|
| MODE:                  | Read Only   |   |   |   |                 |   |   |   |
| BIT                    | 7   | 6 | 5 | 4 | 3               | 2 | 1 | 0 |
| NAME                   | CurLim2Rb[2:0]  |   |   |   | SpvChgIlim[4:0] |   |   |   |
| <b>CurLim2Rb[2:0]</b>  | Active Charger/Boost current as percent of the value set by $R_{SET}$ .<br>0 = 20%<br>1 = 30%<br>2 = 40%<br>3 = 50%<br>4 = 60%<br>5 = 70%<br>6 = 80%<br>7 = 100%      |   |   |   |                 |   |   |   |
| <b>SpvChgIlim[4:0]</b> | SpvChgIlim[4:0] shows the actual input current limit currently set.<br>00000 = 0.10A<br>00001 = 0.20A<br>...<br>11101 = 3.00A<br>11110 = Reserved<br>11111 = Reserved |   |   |   |                 |   |   |   |

**Table 39. BBCFG1 Register (0x23)**

| ADDRESS:               | 0x23  |   |   |   |   |   |   |   |
|------------------------|---|---|---|---|---|---|---|---|
| MODE:                  | Read/Write or Read-Only if AppWrtPrct = "(1) Protected" (See Table 61)  |   |   |   |   |   |   |   |
| BIT                    | 7   | 6 | 5 | 4 | 3 | 2 | 1 | 0 |
| NAME                   | BoostRComp[3:0]   |   |   |   | - | - | - | - |
| <b>BoostRComp[3:0]</b> | Sets the internal compensation resistor for the boost mode<br>0000 = 9.5k $\Omega$<br>0001 = 17.3k $\Omega$<br>0010 = 25.3k $\Omega$<br>0011 = 33.2k $\Omega$<br>0100 = 41.4k $\Omega$<br>0101 = 49.2k $\Omega$<br>0110 = 57.3k $\Omega$<br>0111 = 65.1k $\Omega$<br>1000 = 73.6k $\Omega$<br>1001 = 81.4k $\Omega$<br>1010 = 89.4k $\Omega$<br>1011 = 97.2k $\Omega$<br>1100 = 105.5k $\Omega$<br>1101 = 113.3k $\Omega$<br>1110 = 121.4k $\Omega$<br>1111 = 129.2k $\Omega$ |   |   |   |   |   |   |   |

**Table 40. BBCFG2 Register (0x24)**

|                      |   |          |          |          |               |          |          |          |
|----------------------|---|----------|----------|----------|---------------|----------|----------|----------|
| <b>ADDRESS:</b>      | 0x24  |          |          |          |               |          |          |          |
| <b>MODE:</b>         | Read/Write or Read-Only if AppWrtPrct = "(1) Protected" (See Table 61)  |          |          |          |               |          |          |          |
| <b>BIT</b>           | <b>7</b>  | <b>6</b> | <b>5</b> | <b>4</b> | <b>3</b>      | <b>2</b> | <b>1</b> | <b>0</b> |
| <b>NAME</b>          | -   | -        | -        | BBFrcZX  | BuckVSet[3:0] |          |          |          |
| <b>BBFrcZX</b>       | BBFrcZX sets the Buck in forced ZX mode.<br>0 = Forced PWM Mode<br>1 = Forced ZX Mode   |          |          |          |               |          |          |          |
| <b>BuckVSet[3:0]</b> | Buck Regulation Voltage<br>0000 = 4.0V<br>0001 = 4.1V<br>0010 = 4.2V<br>0011 = 4.3V<br>0100 = 4.4V<br>0101 = 4.5V<br>0110 = 4.6V<br>0111 = 4.7V<br>1000 = 4.8V<br>1001 = 4.9V<br>1010 = 5.0V<br>1011 = 5.1V<br>1100 = 5.2V<br>1101 = 5.3V<br>1110 = 5.4V<br>1111 = 5.5V |          |          |          |               |          |          |          |



**Table 41. BC Ctrl1 Register (0x25)**

|                       |  |          |          |          |                |          |           |          |
|-----------------------|--|----------|----------|----------|----------------|----------|-----------|----------|
| <b>ADDRESS:</b>       | <b>0x25</b>  |          |          |          |                |          |           |          |
| <b>MODE:</b>          | <b>Read/Write</b>  |          |          |          |                |          |           |          |
| <b>BIT</b>            | <b>7</b>   | <b>6</b> | <b>5</b> | <b>4</b> | <b>3</b>       | <b>2</b> | <b>1</b>  | <b>0</b> |
| <b>NAME</b>           | DCD2s  | SfOutLvl | -        | ADC3PDet | SfOutCtrl[1:0] |          | ChgDetMan | ChgDetEn |
| <b>DCD2s</b>          | DCD2s sets the timing of DCD in BC1.2<br>0 = standard<br>1 = 2s  |          |          |          |                |          |           |          |
| <b>SfOutLvl</b>       | SFOUT Voltage Level Select<br>0 = 5V<br>1 = 3.3V   |          |          |          |                |          |           |          |
| <b>ADC3PDet</b>       | 3A DCP Detection Enable (adds detection step after BC1.2 completes to detect presence of 3A DCP)<br>0 = Not Enabled<br>1 = Enabled   |          |          |          |                |          |           |          |
| <b>SfOutCtrl[1:0]</b> | Safe Out LDO SFOUT Control<br>00 = Always Disabled<br>01 = On if a valid CHGIN voltage is present<br>10 = Turns on under following conditions.<br>a. ChgDetEn = 1, CHGIN is valid, and BC1.2 FSM Detection is finished<br>b. ChgDetEn = 0, and CHGIN is valid<br>11: RFU<br><br><b>Note:</b> CHGIN valid can be external CHGIN voltage or CHGIN voltage generated by reverse buck in Attached. SRC_CCx mode. A system that supports power swap must not use SFOUT LDO to supply USB transceiver. According to USB PD specification, CHGIN will collapse during power swap. This turns off SFOUT LDO which is supplied from CHGIN, and kills USB communication. |          |          |          |                |          |           |          |
| <b>ChgDetMan</b>      | ChgDetMan forces manual run of charger detection. (Bit auto-resets to 0)<br>0 = Not enabled<br>1 = Request manual run of charger detection   |          |          |          |                |          |           |          |
| <b>ChgDetEn</b>       | Charger Detection Enable<br>0 = Not enabled<br>1 = Enabled (charger detection runs every time $V_{CHGIN} > V_{BDET}$ and $DetAbrt = 0$ )   |          |          |          |                |          |           |          |

**Table 42. Reserved Register (0x26)**

|                 |           |   |   |   |   |   |   |   |
|-----------------|-----------|---|---|---|---|---|---|---|
| <b>ADDRESS:</b> | 0x26      |   |   |   |   |   |   |   |
| <b>MODE:</b>    | Read Only |   |   |   |   |   |   |   |
| <b>BIT</b>      | 7         | 6 | 5 | 4 | 3 | 2 | 1 | 0 |
| <b>NAME</b>     | -         | - | - | - | - | - | - | - |

**Table 43. CCtrl1 Register (0x27)**

|                 |  |   |   |          |          |         |         |         |
|-----------------|--|---|---|----------|----------|---------|---------|---------|
| <b>ADDRESS:</b> | 0x27   |   |   |          |          |         |         |         |
| <b>MODE:</b>    | Read/Write   |   |   |          |          |         |         |         |
| <b>BIT</b>      | 7  | 6 | 5 | 4        | 3        | 2       | 1       | 0       |
| <b>NAME</b>     | -  | - | - | CCSrcSnk | CCSnkSrc | CCDbgEn | CCAudEn | CCDetEn |
| <b>CCSrcSnk</b> | Allow State machine to enter Sink Mode (DFP) detection. Note USB PD role swap is allowed to enter Source mode.<br>0 = Disable<br>1 = Enable    |   |   |          |          |         |         |         |
| <b>CCSnkSrc</b> | Allow State machine to enter Source Mode (DFP) detection. Note USB PD role swap is allowed to enter Source mode.<br>0 = Disable<br>1 = Enabled |   |   |          |          |         |         |         |
| <b>CCDbgEn</b>  | Enable Detection of Type-C Debug Adapter<br>0 = Disabled<br>1 = Enabled  |   |   |          |          |         |         |         |
| <b>CCAudEn</b>  | Enable Detection of Type-C Audio Adapter<br>0 = Disabled<br>1 = Enabled  |   |   |          |          |         |         |         |
| <b>CCDetEn</b>  | Enable CC Pin Detection – Force State Machine to Disabled State.<br>0 = Disabled<br>1 = Enabled  |   |   |          |          |         |         |         |

Table 44. CCtrl2 Register (0x28)

| ADDRESS:               | 0x28   |                 |             |             |          |         |          |          |
|------------------------|--|-----------------|-------------|-------------|----------|---------|----------|----------|
| MODE:                  | Read/Write   |                 |             |             |          |         |          |          |
| BIT                    | 7  | 6               | 5           | 4           | 3        | 2       | 1        | 0        |
| NAME                   | CCForceError   | SnkAttachedLock | CCSnkSrcSwp | CCSrcSnkSwp | CCVcnSwp | CCVcnEn | CCSrcRst | CCSnkRst |
| <b>CCForceError</b>    | Bit resets to 0 after a write (This bit resets to 0 automatically when action is done)<br>0 = No action<br>1 = Force transition to ErrorRecovery state.  |                 |             |             |          |         |          |          |
| <b>SnkAttachedLock</b> | Bit resets to 0 after a minimum of 1.1s<br>0 = Exit Attached.SNK* state when $V_{CHGIN} < V_{BDET}$ for more than $t_{PDDEB}$<br>1 = Locked in Attached.SNK* state for a minimum of 1.1s if VBUS not present         |                 |             |             |          |         |          |          |
| <b>CCSnkSrcSwp</b>     | USB PD Power role swap from Sink to Source. This bit must be written to 0 once the USB PD controller completes the power role swap sequence<br>0 = No Swap Requested<br>1 = Swap Requested                           |                 |             |             |          |         |          |          |
| <b>CCSrcSnkSwp</b>     | USB PD Power role swap from Source to Sink. This bit must be written to 0 once the USB PD controller completes the power role swap sequence<br>0 = No Swap Requested<br>1 = Swap Requested                           |                 |             |             |          |         |          |          |
| <b>CCVcnSwp</b>        | Signal State Machine to Swap $V_{CONN}$ roles. Bit resets to 0 after a write (Note this bit will reset to 0 automatically when action is done)<br>0 = No change in $V_{CONN}$ role<br>1 = force change in $V_{CONN}$ |                 |             |             |          |         |          |          |
| <b>CCVcnEn</b>         | Force state of $V_{CONN}$<br>0 = Force $V_{CONN}$ off (both external Buck converter and $V_{CONN}$ switch)<br>1 = Automatic operation based on State Machine   |                 |             |             |          |         |          |          |
| <b>CCSrcRst</b>        | Force a reset of the State Machine – Immediate transition to Unattached.SRC* state. Bit resets to 0 after a write.<br>0 = No reset<br>1 = Request reset  |                 |             |             |          |         |          |          |
| <b>CCSnkRst</b>        | Force a reset of the State Machine – Immediate transition to Unattached.SNK* state. Bit resets to 0 after a write.<br>0 = No reset<br>1 = Request reset  |                 |             |             |          |         |          |          |

\* Attached.SNK, Unattached.SRC, and Unattached.SNK are defined in USB Type-C Specificaiton Release 1.1.

**Table 45. CCtrl3 Register (0x29)**

|                        |   |          |          |          |          |             |                 |          |
|------------------------|---|----------|----------|----------|----------|-------------|-----------------|----------|
| <b>ADDRESS:</b>        | <b>0x29</b>   |          |          |          |          |             |                 |          |
| <b>MODE:</b>           | <b>Read/Write</b>   |          |          |          |          |             |                 |          |
| <b>BIT</b>             | <b>7</b>  | <b>6</b> | <b>5</b> | <b>4</b> | <b>3</b> | <b>2</b>    | <b>1</b>        | <b>0</b> |
| <b>NAME</b>            | -   | -        | -        | -        | CCTrySnk | CCPreferSnk | CCDRPPhase[1:0] |          |
| <b>CCTrySnk</b>        | Enable transition from AttachWait.SRC* to Try.SNK* then to Attach.SNK_CCx* or to TryWait.SRC* for DRP that strongly prefers the SNK role. CCTrySnk has higher priority than CCPreferSnk.<br>0 = Disabled<br>1 = Enabled |          |          |          |          |             |                 |          |
| <b>CCPreferSnk</b>     | Enable transition from Unattached.SRC* to Try.SNK* then to Unattached.SNK* for DRP that strongly prefers the SNK role.<br>0 = Disabled<br>1 = Enabled   |          |          |          |          |             |                 |          |
| <b>CCDRPPhase[1:0]</b> | Percent of time device is acting as Unattached.SRC* when CCSNKSRC = 1<br>00 = 35%<br>01 = 40%<br>10 = 45%<br>11 = 50%   |          |          |          |          |             |                 |          |

\* AttachWait.SRC, Try.SNK, Attached.SNK, TryWait.SRC, Unattached.SNK, and Unattached SRC are defined in USB Type-C Specification Release 1.1.

**Table 46. CHGINILim1 Register (0x2A)**

|                       |  |                |          |          |          |          |          |          |
|-----------------------|--|----------------|----------|----------|----------|----------|----------|----------|
| <b>ADDRESS:</b>       | <b>0x2A</b>  |                |          |          |          |          |          |          |
| <b>MODE:</b>          | <b>Read Only</b>   |                |          |          |          |          |          |          |
| <b>BIT</b>            | <b>7</b>   | <b>6</b>       | <b>5</b> | <b>4</b> | <b>3</b> | <b>2</b> | <b>1</b> | <b>0</b> |
| <b>NAME</b>           | -  | CHGINILim[6:0] |          |          |          |          |          |          |
| <b>CHGINILim[6:0]</b> | Status of charger input current limit set by charger detection (in 33mA step). Note that the first 4 codes are all 100mA.<br>0000000 = 100mA<br>0000001 = 100mA<br>0000010 = 100mA<br>0000011 = 100mA<br>0000100 = 133mA<br>0000011 = 166mA<br>...<br>1111111 = 4059mA |                |          |          |          |          |          |          |

**Table 47. CHGINILim2 Register (0x2B)**

|                       |  |          |          |          |               |                |          |           |
|-----------------------|--|----------|----------|----------|---------------|----------------|----------|-----------|
| <b>ADDRESS:</b>       | <b>0x2B</b>  |          |          |          |               |                |          |           |
| <b>MODE:</b>          | <b>Read/Write</b>  |          |          |          |               |                |          |           |
| <b>BIT</b>            | <b>7</b>   | <b>6</b> | <b>5</b> | <b>4</b> | <b>3</b>      | <b>2</b>       | <b>1</b> | <b>0</b>  |
| <b>NAME</b>           | -  | -        | -        | -        | CHGINILimGate | SDPMaxCur[1:0] |          | CDPMaxCur |
| <b>CHGINILimGate</b>  | CHGINILim Control options<br>0 = No gating of CHGINILim setting by BC1.2 FSM<br>1 = Gate changes in CHGINILim until BC1.2 FSM completes – ChgTypRun = 0  |          |          |          |               |                |          |           |
| <b>SDPMaxCur[1:0]</b> | SDP Nonstandard Type-C Cable Control. USB-C to USB-A cables may have incorrect CC resistor indicating 1.5A or 3A. Requires CHGINILimGate = 1.<br>00 = No modification of CHGIN_LIM<br>01 = Limit SDP to 500mA. ChgTyp = 01 (SDP) and PrChgTyp = 000 (unknown) set CHGINILim[6:0] to 0x0F<br>10 = Limit SDP to 1.0A. ChgTyp = 01 (SDP) and PrChgTyp = 000 (unknown) set CHGINILim[6:0] to 0x1E<br>11 = Limit SDP to 1.5A. ChgTyp = 01 (SDP) and PrChgTyp = 000 (unknown) set CHGINILim[6:0] to 0x2D |          |          |          |               |                |          |           |
| <b>CDPMaxCur</b>      | CDP Nonstandard Type-C cable control. USB-C to USB-A cables may have incorrect CC resistor indicating 3A. Requires CHGIN_LIM_Gate = 1.<br>0 = No modification of CHGIN_LIM<br>1 = Limit CDP to 1.5A. ChgTyp = 10 (CDP) and PrChgTyp = 000 (unknown) set CHGINILim[6:0] to 0x2D   |          |          |          |               |                |          |           |

**Table 48. AICLCFG1 Register (0x2C)**

|                  |  |          |          |          |          |          |          |           |
|------------------|--|----------|----------|----------|----------|----------|----------|-----------|
| <b>ADDRESS:</b>  | <b>0x2C</b>  |          |          |          |          |          |          |           |
| <b>MODE:</b>     | <b>Read/Write or Read-Only if AppWrtPrctc = “(1) Protected” (See Table 61)</b>   |          |          |          |          |          |          |           |
| <b>BIT</b>       | <b>7</b>   | <b>6</b> | <b>5</b> | <b>4</b> | <b>3</b> | <b>2</b> | <b>1</b> | <b>0</b>  |
| <b>NAME</b>      | AICLEn   | -        | -        | -        | -        | -        | -        | AICLAbort |
| <b>AICLEn</b>    | AICL Enable. Writing 1 to AICLEn enables AICL operation. Note that if AICLAbort is 1, AICL operation is not allowed. This bit auto-resets to 0.<br>0 = No Action<br>1 = AICL enabled               |          |          |          |          |          |          |           |
| <b>AICLAbort</b> | High Priority AICL Abort.<br>0 = Device is allowed to run AICL by writing 1 to AICLEn.<br>1 = Device is NOT allowed to run AICL operation. AICL operation will be aborted if it's already running. |          |          |          |          |          |          |           |

**Table 49. AICLCFG2 Register (0x2D)**

|                      |   |   |   |               |   |   |   |   |
|----------------------|---|---|---|---------------|---|---|---|---|
| <b>ADDRESS:</b>      | 0x2D  |   |   |               |   |   |   |   |
| <b>MODE:</b>         | Read/Write or Read-Only if AppWrtPrct = "(1) Protected" (See Table 61)  |   |   |               |   |   |   |   |
| <b>BIT</b>           | 7   | 6 | 5 | 4             | 3 | 2 | 1 | 0 |
| <b>NAME</b>          | BYPUVLO[2:0]  |   |   | AICLMaxI[4:0] |   |   |   |   |
| <b>BYPUVLO[2:0]</b>  | VBUS Theshold below which AICL stops incrementing the current<br>000 = 3.8V<br>001 = 3.9V<br>010 = 4.0V<br>011 = 4.1V<br>100 = 4.2V<br>101 = 4.3V<br>110 = 4.4V<br>111 = 4.5V |   |   |               |   |   |   |   |
| <b>AICLMaxI[4:0]</b> | AICL Stop Current (in 100mA step)<br>00000 = 100mA<br>00001 = 200mA<br>...<br>11111 = 3.2A  |   |   |               |   |   |   |   |

**Table 50. AICLCFG3 Register (0x2E)**

|                       |   |   |   |        |               |   |                |   |
|-----------------------|---|---|---|--------|---------------|---|----------------|---|
| <b>ADDRESS:</b>       | 0x2E  |   |   |        |               |   |                |   |
| <b>MODE:</b>          | Read/Write or Read-Only if AppWrtPrct = "(1) Protected" (See Table 61)      |   |   |        |               |   |                |   |
| <b>BIT</b>            | 7   | 6 | 5 | 4      | 3             | 2 | 1              | 0 |
| <b>NAME</b>           | -   | - | - | BYPDeb | AICLTBIk[1:0] |   | AICLTStep[1:0] |   |
| <b>BYPDeb</b>         | AICL BYPUVLO[2:0] Rise Threshold Debounce Setting<br>0 = 500µs<br>1 = 200µs |   |   |        |               |   |                |   |
| <b>AICLTBIk[1:0]</b>  | TBLANK Time Setting<br>00 = 500ms<br>01 = 1s<br>10 = 1.5s<br>11 = 5s        |   |   |        |               |   |                |   |
| <b>AICLTStep[1:0]</b> | TSTEP Time Setting<br>00 = 100ms<br>01 = 200ms<br>10 = 300ms<br>11 = 500ms  |   |   |        |               |   |                |   |

**Table 51. DPDNSw Register (0x2F)**

|                      |  |   |   |   |   |   |               |   |
|----------------------|--|---|---|---|---|---|---------------|---|
| <b>ADDRESS:</b>      | 0x2F   |   |   |   |   |   |               |   |
| <b>MODE:</b>         | Read/Write   |   |   |   |   |   |               |   |
| <b>BIT</b>           | 7  | 6 | 5 | 4 | 3 | 2 | 1             | 0 |
| <b>NAME</b>          | -  | - | - | - | - | - | AnSwCntl[1:0] |   |
| <b>AnSwCntl[1:0]</b> | AnSwCntl Analog Switch Configuration<br>00 = Auto. Switch is open during adapter detection. Switch closes if SDP or CDP is detected.<br>01 = Auto in SDP or CDP and Buck mode is detected.<br>10 = Switch forced open<br>11 = Switch forced closed |   |   |   |   |   |               |   |

**Table 52. Others Register (0x30)**

|                 |  |   |   |   |   |   |   |          |
|-----------------|--|---|---|---|---|---|---|----------|
| <b>ADDRESS:</b> | 0x30   |   |   |   |   |   |   |          |
| <b>MODE:</b>    | Read/Write   |   |   |   |   |   |   |          |
| <b>BIT</b>      | 7  | 6 | 5 | 4 | 3 | 2 | 1 | 0        |
| <b>NAME</b>     | -  | - | - | - | - | - | - | USBCRSet |
| <b>USBCRSet</b> | USB-C Registers Reset. Writing 1 to USBCRSet resets registers associated with USB-C operation. (Note that this operation opens the input limiter and turns off the boost converter temporarily.) Reset types are RST3 and RST4. See Table 59 and Table 60 for more details. This bit auto-resets to 0.<br>0 = No Action<br>1 = Reset Registers |   |   |   |   |   |   |          |

**Table 53. Reserved Register (0x31)**

|                 |           |   |   |   |   |   |   |   |
|-----------------|-----------|---|---|---|---|---|---|---|
| <b>ADDRESS:</b> | 0x31      |   |   |   |   |   |   |   |
| <b>MODE:</b>    | Read Only |   |   |   |   |   |   |   |
| <b>BIT</b>      | 7         | 6 | 5 | 4 | 3 | 2 | 1 | 0 |
| <b>NAME</b>     | -         | - | - | - | - | - | - | - |

**Table 54. Reserved Register (0x32)**

|                 |           |   |   |   |   |   |   |   |
|-----------------|-----------|---|---|---|---|---|---|---|
| <b>ADDRESS:</b> | 0x32      |   |   |   |   |   |   |   |
| <b>MODE:</b>    | Read Only |   |   |   |   |   |   |   |
| <b>BIT</b>      | 7         | 6 | 5 | 4 | 3 | 2 | 1 | 0 |
| <b>NAME</b>     | -         | - | - | - | - | - | - | - |

**Table 55. LowPow Register (0x33)**

|                    |   |   |   |   |   |   |   |             |
|--------------------|---|---|---|---|---|---|---|-------------|
| <b>ADDRESS:</b>    | 0x33  |   |   |   |   |   |   |             |
| <b>MODE:</b>       | Read/Write  |   |   |   |   |   |   |             |
| <b>BIT</b>         | 7   | 6 | 5 | 4 | 3 | 2 | 1 | 0           |
| <b>NAME</b>        | LowPowEn  | - | - | - | - | - | - | LowPowAbort |
| <b>LowPowEn</b>    | <p>Low Power Mode Enable. Set LowPowEn to 1 to enter Low Power mode. Note that if LowPowAbort is 1, Low Power Mode is not allowed. This bit auto-resets to 0.</p> <p>0 = No Action<br/>1 = Enter Low Power mode</p>                             |   |   |   |   |   |   |             |
| <b>LowPowAbort</b> | <p>High Priority Low Power Mode Abort</p> <p>0 = Device is allowed to enter Low Power mode by writing 1 to LowPowEn.<br/>1 = Device is NOT allowed to enter Low Power Mode. Low Power Mode will be exited if device has already entered it.</p> |   |   |   |   |   |   |             |

**Table 56. Reserved Register (0x34)**

|                 |           |   |   |   |   |   |   |   |
|-----------------|-----------|---|---|---|---|---|---|---|
| <b>ADDRESS:</b> | 0x34      |   |   |   |   |   |   |   |
| <b>MODE:</b>    | Read Only |   |   |   |   |   |   |   |
| <b>BIT</b>      | 7         | 6 | 5 | 4 | 3 | 2 | 1 | 0 |
| <b>NAME</b>     | -         | - | - | - | - | - | - | - |

**Table 57. FLTSEL Register (0x35)**

|                      |  |   |   |   |   |   |   |   |
|----------------------|--|---|---|---|---|---|---|---|
| <b>ADDRESS:</b>      | 0x35   |   |   |   |   |   |   |   |
| <b>MODE:</b>         | Read/Write   |   |   |   |   |   |   |   |
| <b>BIT</b>           | 7  | 6 | 5 | 4 | 3 | 2 | 1 | 0 |
| <b>NAME</b>          | FLTSelect[1:0]   |   | - | - | - | - | - | - |
| <b>FLTSelect[10]</b> | <p><math>\overline{\text{FLTIN}}</math> Charger-Faulting and External Reset Function Enable</p> <p>00 = No effect and internally ignored</p> <p>01 = Low on <math>\overline{\text{FLTIN}}</math> pin (60<math>\mu</math>s debounce) places the charger in Battery Fault Charge Suspend state (ChgStat[3:0] = 1000).</p> <p>1x = Falling edge on <math>\overline{\text{FLTIN}}</math> pin resets all registers. Reset types are RST1/RST2/RST3. See Table 59 and Table 60 for more details.</p> |   |   |   |   |   |   |   |



## Applications Information

### Component Selection

The correct selection of external components ensures high efficiency, low output ripple, and fast transient response.

### Inductor Selection

The MAX14748 is designed to use a 1.5 $\mu$ H or 2.2 $\mu$ H inductor. See [Table 58](#) for suggested inductors and manufacturers.

### BAT Capacitor Selection

BAT capacitor is required to keep the BAT voltage ripple small and to ensure regulation loop stability. The BAT capacitor must have low impedance at the switching frequency. Ceramic capacitors with X5R or X7R dielectric are highly recommended due to their small size, low ESR, and small temperature coefficients.

BAT requires careful bypassing. In the PCB layout, place BAT capacitor as close as possible to BAT to minimize parasitic inductance. If making connections to BAT capacitor through vias, ensure that the vias are rated for the expected input current to avoid excess inductance and resistance between the capacitor and BAT.

The recommended nominal BAT capacitance is 22 $\mu$ F, however, after initial tolerance, bias voltage, aging, and temperature derating, the effective capacitance must be greater than 10 $\mu$ F. To ensure regulation loop stability, the effective BAT capacitance should be chosen within the range of 10 $\mu$ F to 30 $\mu$ F.

### SYS Capacitor Selection

SYS capacitor acts as the output capacitor for the boost converter when charging, and the input capacitor for the reverse buck converter when the device is acting as power source in DRP mode. SYS capacitor is required to keep the SYS voltage ripple small and to ensure regulation loop stability. It must have low impedance at the switching frequency. Ceramic capacitors with X5R or X7R dielectric are highly recommended due to their small size, low ESR, and small temperature coefficients.

Place SYS capacitor as close as possible to SYS to minimize parasitic inductance. If making connections to SYS capacitor through vias, ensure that the vias are rated for the expected input current to avoid excess inductance and resistance between the capacitor and SYS.

The recommended nominal SYS capacitance is 40 $\mu$ F, however, after initial tolerance, bias voltage, aging, and temperature derating, the effective capacitance must be greater than 15 $\mu$ F.

### BYP Capacitor Selection

BYP capacitor acts as the input capacitor for the boost converter, and the output capacitor for the reverse buck converter. BYP capacitor reduces the current peaks drawn from the input power source when charging while reducing the output voltage ripple of the reverse buck converter when it is acting as power source in DRP mode. The impedance of the input capacitor at the switching frequency should be very low. Ceramic capacitors with X5R or X7R dielectric are highly recommended due to their small size, low ESR, and small temperature coefficients.

**Table 58. Suggested Inductors**

| APPLICATION        | INDUCTANCE ( $\mu$ H) | R <sub>DC</sub> (M $\Omega$ ) | SATURATION CURRENT (A) | CURRENT RATING (A) | SUGGESTED PARTS             |
|--------------------|-----------------------|-------------------------------|------------------------|--------------------|-----------------------------|
| 3A Type-C Adapters | 2.2 $\mu$ H           | 26                            | 4.2                    | 3.7                | Taiyo Yuden NRS6028T2R2NMGJ |
|                    | 2.2 $\mu$ H           | 80                            | 3.5                    | 2.8                | BOURNS SRP4012TA-2R2M       |

**Table 59. Reset Types**

| RESET TYPE | RESET CONDITION   |
|------------|---|
| RST        | 1. V <sub>CCINT</sub> Power-On Reset  |
| RST1       | 1. V <sub>CCINT</sub> Power-On Reset or<br>2. $\overline{\text{FLTIN}}$ falling edge (only if FLTSelect[1] = 1)   |
| RST2       | 1. V <sub>CCINT</sub> Power-On Reset or<br>2. $\overline{\text{FLTIN}}$ falling edge (only if FLTSelect[1] = 1)   |
| RST3       | 1. V <sub>CCINT</sub> Power-On Reset or<br>2. $\overline{\text{FLTIN}}$ falling edge (only if FLTSelect[1] = 1) or<br>3. USB-C reset through USBCRSet (0x30[0]) |

BYP requires careful bypassing. In the PCB layout, place BYP capacitor as close as possible to the BYP to minimize parasitic inductance. If making connections to BYP capacitor through vias, ensure that the vias are rated for the expected input current to avoid excess inductance and resistance between the capacitor and BYP.

The recommended nominal BYP capacitance is 22 $\mu$ F, however, after initial tolerance, bias voltage, aging, and temperature derating, the effective capacitance must be greater than 10 $\mu$ F.

### **CHGIN Capacitor Selection**

CHGIN capacitor decouples a charge source and its parasitic impedance. Typically, the charger source at CHGIN is a USB connector's VBUS. The recommended nominal CHGIN capacitance is 1 $\mu$ F. Larger capacitance at CHGIN improves the decoupling; however, take care not to exceed the maximum capacitance allowed by the USB specification.

The impedance of the CHGIN at the DC-DC switching frequency should be very low. Ceramic capacitors with X5R or X7R dielectric are highly recommended due to their small size, low ESR, and small temperature coefficients.

To fully utilize the +30V input capability of the, choose a capacitor with a 35V or greater rating; many applications don't need to utilize the full input capability of the device and find that a 16V or 10V rated input capacitor is sufficient.

### **BST Capacitor Selection**

Choose the nominal BST capacitance to be 0.1 $\mu$ F. BST capacitor is part of a charge pump that creates the high-side gate drive for the DC-DC. It is recommended that the BST capacitor has at least 10V rating.

### **PCB Layout and Routing**

High switching frequencies and large peak currents make PCB layout a very important part of design. Good design minimizes excessive EMI on the feedback paths and voltage gradients in the ground plane, both of which can result in instability or regulation errors. Connect the inductor, input capacitors, and output capacitors as close together as possible, and keep their traces short, direct, and wide. Keep noisy traces, such as the LX node, as short as possible.

Table 60. Register Reset Types and Default Values

| REGISTER ADDRESS    | REGISTER NAME | RESET TYPE | MAX14748 |
|---------------------|---------------|------------|----------|
| 0x00                | ChipID        | RST1       | 0x3E     |
| 0x01                | ChipRev       | RST1       | 0x33     |
| 0x01<br>(MAX14748B) | ChipRev       | RST1       | 0x44     |
| 0x02                | DevStatus1    | RST1       | STATUS*  |
| 0x03                | AICLStatus    | RST1       | STATUS   |
| 0x04                | DevStatus2    | RST1       | STATUS   |
| 0x05                | ChgStatus     | RST1       | STATUS   |
| 0x06                | JEITAStatus   | RST1       | STATUS   |
| 0x07                | BCStatus      | RST3       | STATUS   |
| 0x08                | Reserved      | —          | 0x00     |
| 0x09                | CCStatus1     | RST3       | STATUS   |
| 0x0A                | CCStatus2     | RST3       | STATUS   |
| 0x0B                | DevInt1       | RST1       | INT*     |
| 0x0C                | AICLInt       | RST1       | INT      |
| 0x0D                | DevInt2       | RST1       | INT      |
| 0x0E                | ChgInt        | RST1       | INT      |
| 0x0F                | JEITAInt      | RST1       | INT      |
| 0x10                | BCInt         | RST3       | INT      |
| 0x11                | CCInt         | RST3       | INT      |
| 0x12                | DevInt1Mask   | RST1       | 0xFF     |
| 0x13                | AICLIntMask   | RST1       | 0x40     |
| 0x14                | DevInt2Mask   | RST1       | 0x7F     |
| 0x15                | ChgIntMask    | RST1       | 0xF1     |
| 0x16                | JEITAIntMask  | RST1       | 0x19     |
| 0x17                | BCIntMask     | RST3       | 0xFF     |
| 0x18                | CCIntMask     | RST3       | 0x7F     |
| 0x19                | LED_CTRL      | RST1       | 0x00     |
| 0x1A                | ThermaCfg1    | RST2       | 0x7D     |
| 0x1B                | ThermaCfg2    | RST2       | 0xEF     |

| REGISTER ADDRESS    | REGISTER NAME  | RESET TYPE | MAX14748 |
|---------------------|----------------|------------|----------|
| 0x1C                | ThermaCfg3     | RST2       | 0x02     |
| 0x1D                | ChargerCtrl1   | RST2       | 0x80     |
| 0x1E                | ChargerCtrl2   | RST2       | 0x10     |
| 0x1F                | ChargerCtrl3   | RST2       | 0x49     |
| 0x20                | ChargerCtrl4** | RST2       | 0x06     |
| 0x21                | CurLimCtrl     | RST2       | 0x00     |
| 0x22                | CurLimStatus   | RST1       | STATUS   |
| 0x23                | BBCFG1         | RST1       | 0x20     |
| 0x24                | BBCFG2         | RST1       | 0x8A     |
| 0x25                | BCCtrl1        | RST3       | 0x05     |
| 0x26                | Reserved       | —          | 0x00     |
| 0x27                | CCCtrl1        | RST3       | 0x19     |
| 0x27<br>(MAX14748B) | CCCtrl1        | RST3       | 0x11     |
| 0x28                | CCCtrl2        | RST3       | 0x04     |
| 0x29                | CCCtrl3        | RST3       | 0x08     |
| 0x2A                | CHGINILim1     | RST3       | STATUS   |
| 0x2B                | CHGINILim2     | RST3       | 0x0B     |
| 0x2C                | AICLCFG1       | RST1       | 0x01     |
| 0x2D                | AICLCFG2       | RST1       | 0x44     |
| 0x2E                | AICLCFG3       | RST1       | 0x05     |
| 0x2F                | DPDNSw         | RST2       | 0x01     |
| 0x30                | Others         | RST1       | 0x00     |
| 0x31                | Reserved       | —          | 0x00     |
| 0x32                | Reserved       | —          | 0x00     |
| 0x33                | LowPow         | RST1       | 0x01     |
| 0x34                | Reserved       | —          | 0x01     |
| 0x35                | FLTSEL         | RST        | 0x80     |

\*INT and STATUS: status and interrupt register values vary based on device operating condition.

\*\* ChargerCtrl4 register value depends on the status of WeakBatStat[2:0] bits.

**Table 61. Register Bit Default Values**

| REGISTER BITS  | VALUES       |
|----------------|--------------|
| CDPMaxCur      | 1500mA       |
| SDPMaxCur[1:0] | 500mA        |
| CHGINLimGate   | Gating       |
| CCAudEn        | Disabled     |
| CCDbgEn        | Disabled     |
| CCSnkSrc       | Disabled     |
| CCSrcSnk       | Enabled      |
| JeitaCfgR[1:0] | "01"         |
| CCDRPPhase[1]  | 35% or 40%   |
| CCTrySnk       | Enabled      |
| SfOutCtrl[1:0] | "01"         |
| ADC3PDet       | Disabled     |
| DCD2s          | Standard     |
| WarmCoolSel    | 45°C/10°C    |
| T1T2IFchg[2:0] | 0.5 x IFChg  |
| T3T4IFchg[2:0] | 1.0 x IFChg  |
| BatReg[1:0]    | 8.3V         |
| ChgEn          | Disabled     |
| JETIActrSet    | (1) Control  |
| IPChg[1:0]     | 0.05 x IFChg |
| ChgDone[1:0]   | 0.05 x IFChg |
| ChgAutoStp     | Enabled      |
| BatReChg[1:0]  | 200mV        |

| REGISTER BITS   | VALUES       |
|-----------------|--------------|
| FreshBatDis     | Done         |
| ChgAutoSta      | Enabled      |
| MtChgTmr[1:0]   | 0min         |
| FChgTmr[1:0]    | 300min       |
| PChgTmr[1:0]    | 60min        |
| ChipRevH[3:0]   | 3            |
| AppWrtPrctct    | (0) Writable |
| VPchg[2:0]      | 5.8V         |
| T3T4ENset       | Enabled      |
| T1T2ENset       | Enabled      |
| T3T4VFset       | Enabled      |
| T1T2VFset       | Enabled      |
| T2T3IFchg[2:0]  | 1.0 x IFChg  |
| BoostRComp[3:0] | 2            |
| FLTSelect[1:0]  | (10) Reset   |
| BuckVSet[3:0]   | 5.0V         |
| AnSwCntl[1:0]   | (01) Auto    |
| AICLTStep[1:0]  | 200ms        |
| WeakBatEna      | Enabled      |
| BYPUVLO[2:0]    | 4.0V         |
| AICLMax[4:0]    | 500mA        |
| BYPDeb          | 500µs        |
| AICLTBlk[1:0]   | 1000ms       |



### Ordering Information

| PART           | TEMP RANGE     | PIN-PACKAGE |
|----------------|----------------|-------------|
| MAX14748EWW+   | -40°C to +85°C | 54 WLP      |
| MAX14748EWW+T  | -40°C to +85°C | 54 WLP      |
| MAX14748BEWW+  | -40°C to +85°C | 54 WLP      |
| MAX14748BEWW+T | -40°C to +85°C | 54 WLP      |

+Denotes a lead(Pb)-free package/RoHS-compliant package.

See [Table 61](#) for the device differences.

T = Tape and reel.

### Chip Information

PROCESS: BiCMOS

## Revision History

| REVISION NUMBER | REVISION DATE | DESCRIPTION   | PAGES CHANGED                                |
|-----------------|---------------|---|--|
| 0               | 6/17          | Initial release   | —  |
| 1               | 12/17         | Added MAX14748C as future product   | 1, 6, 27, 29, 35, 36, 52, 58, 59, 67, 68, 70 |
| 2               | 3/18          | Updated <i>Bump Configuration</i> , Figure 4, <i>Register Map</i> , Table 33, Table 60, and <i>Ordering Information</i> table           | 15, 27, 35, 52,                              |
| 3               | 4/18          | Updated the <i>Electrical Characteristics</i> table, <i>Register Map</i> , Tables 8, 17, 24, 33   | 3, 35, 38, 43, 47, 52                        |
| 3.1             | 5/18          | Corrected <i>Bump Configuration</i> diagram   | 15   |
| 4               | 5/18          | Corrected <i>Bump Configuration</i> diagram   | 15   |
| 5               | 9/18          | Updated the <i>Electrical Characteristics</i> table, <i>Typical Operating Characteristics</i> global conditions, and Table 60.          | 2–14, 67                                     |
| 6               | 10/18         | Updated Table 59 and Table 61; corrected footnote and formatting for Table 3, and corrected typos in Register Tables to say “Read-Only” | 36, 52–56, 61–62, 65, 68                     |
| 7               | 3/19          | Updated the <i>Electrical Characteristics</i> table and Figure 4  | 8, 27  |
| 8               | 7/19          | Added the <i>Deeply Discharged Battery</i> section  | 30   |

For pricing, delivery, and ordering information, please visit Maxim Integrated's online storefront at <https://www.maximintegrated.com/en/storefront/storefront.html>.

Maxim Integrated cannot assume responsibility for use of any circuitry other than circuitry entirely embodied in a Maxim Integrated product. No circuit patent licenses are implied. Maxim Integrated reserves the right to change the circuitry and specifications without notice at any time. The parametric values (min and max limits) shown in the *Electrical Characteristics* table are guaranteed. Other parametric values quoted in this data sheet are provided for guidance.



## Стандарт Электрон Связь

Мы молодая и активно развивающаяся компания в области поставок электронных компонентов. Мы поставляем электронные компоненты отечественного и импортного производства напрямую от производителей и с крупнейших складов мира.

Благодаря сотрудничеству с мировыми поставщиками мы осуществляем комплексные и плановые поставки широчайшего спектра электронных компонентов.

Собственная эффективная логистика и склад в обеспечивает надежную поставку продукции в точно указанные сроки по всей России.

Мы осуществляем техническую поддержку нашим клиентам и предпродажную проверку качества продукции. На все поставляемые продукты мы предоставляем гарантию .

Осуществляем поставки продукции под контролем ВП МО РФ на предприятия военно-промышленного комплекса России , а также работаем в рамках 275 ФЗ с открытием отдельных счетов в уполномоченном банке. Система менеджмента качества компании соответствует требованиям ГОСТ ISO 9001.

Минимальные сроки поставки, гибкие цены, неограниченный ассортимент и индивидуальный подход к клиентам являются основой для выстраивания долгосрочного и эффективного сотрудничества с предприятиями радиоэлектронной промышленности, предприятиями ВПК и научно-исследовательскими институтами России.

С нами вы становитесь еще успешнее!

### Наши контакты:

**Телефон:** +7 812 627 14 35

**Электронная почта:** [sales@st-electron.ru](mailto:sales@st-electron.ru)

**Адрес:** 198099, Санкт-Петербург,  
Промышленная ул, дом № 19, литера Н,  
помещение 100-Н Офис 331