

## High Efficiency LED, Ø 5 mm Tinted Non-Diffused Package



19223

### DESCRIPTION

The TLH.52.. series was developed for standard applications like general indicating and lighting purposes.

It is housed in a 5 mm tinted non-diffused plastic package. The small viewing angle of these devices provides a high brightness.

Several selection types with different luminous intensities are offered. All LEDs are categorized in luminous intensity groups. The green and yellow LEDs are categorized additionally in wavelength groups.

That allows users to assemble LEDs with uniform appearance.

### FEATURES

- Choice of three bright colors
- Standard T-1 $\frac{3}{4}$  package
- Small mechanical tolerances
- Suitable for DC and high peak current
- Small viewing angle
- Luminous intensity categorized
- Yellow and green color categorized
- TLH.52.. with stand-offs
- Compliant to RoHS directive 2002/95/EC and in accordance to WEEE 2002/96/EC

**RoHS**  
COMPLIANT

### APPLICATIONS

- Status lights
- Off/on indicator
- Background illumination
- Readout lights
- Maintenance lights
- Legend light

### PRODUCT GROUP AND PACKAGE DATA

- Product group: LED
- Package: 5 mm
- Product series: standard
- Angle of half intensity:  $\pm 14^\circ$

### PARTS TABLE

| PART           | COLOR, LUMINOUS INTENSITY     | TECHNOLOGY   |
|----------------|-------------------------------|--------------|
| TLHR5200       | Red, $I_V = 50$ mcd (typ.)    | GaAsP on GaP |
| TLHR5201       | Red, $I_V = 60$ mcd (typ.)    | GaAsP on GaP |
| TLHR5205       | Red, $I_V = 70$ mcd (typ.)    | GaAsP on GaP |
| TLHY5200       | Yellow, $I_V = 50$ mcd (typ.) | GaAsP on GaP |
| TLHG5200       | Green, $I_V = 40$ mcd (typ.)  | GaP on GaP   |
| TLHG5201       | Green, $I_V = 45$ mcd (typ.)  | GaP on GaP   |
| TLHG5201-AS12Z | Green, $I_V = 45$ mcd (typ.)  | GaP on GaP   |
| TLHG5205       | Green, $I_V = 50$ mcd (typ.)  | GaP on GaP   |
| TLHG5205-AS21  | Green, $I_V = 50$ mcd (typ.)  | GaP on GaP   |

| ABSOLUTE MAXIMUM RATINGS <sup>1)</sup> TLHR520. TLHY520. , TLHG520. |   |            |               |                  |
|---|---|------------|---------------|------------------|
| PARAMETER   | TEST CONDITION                          | SYMBOL     | VALUE         | UNIT             |
| Reverse voltage   |   | $V_R$      | 6             | V                |
| DC Forward current  | $T_{amb} \leq 65\text{ }^\circ\text{C}$ | $I_F$      | 30            | mA               |
| Surge forward current   | $t_p \leq 10\text{ }\mu\text{s}$        | $I_{FSM}$  | 1             | A                |
| Power dissipation   | $T_{amb} \leq 65\text{ }^\circ\text{C}$ | $P_V$      | 100           | mW               |
| Junction temperature  |   | $T_j$      | 100           | $^\circ\text{C}$ |
| Operating temperature range   |   | $T_{amb}$  | - 20 to + 100 | $^\circ\text{C}$ |
| Storage temperature range   |   | $T_{stg}$  | - 55 to + 100 | $^\circ\text{C}$ |
| Soldering temperature   | $t \leq 5\text{ s, 2 mm from body}$     | $T_{sd}$   | 260           | $^\circ\text{C}$ |
| Thermal resistance junction/ambient                                 |   | $R_{thJA}$ | 350           | K/W              |

Note:

<sup>1)</sup>  $T_{amb} = 25\text{ }^\circ\text{C}$ , unless otherwise specified

| OPTICAL AND ELECTRICAL CHARACTERISTICS <sup>1)</sup> TLHR520., RED |                               |          |             |      |          |      |      |
|--|-------------------------------|----------|-------------|------|----------|------|------|
| PARAMETER  | TEST CONDITION                | PART     | SYMBOL      | MIN. | TYP.     | MAX. | UNIT |
| Luminous intensity <sup>2)</sup>                                   | $I_F = 10\text{ mA}$          | TLHR5200 | $I_V$       | 10   | 50       |      | mcd  |
|  |                               | TLHR5201 | $I_V$       | 16   | 60       |      | mcd  |
|  |                               | TLHR5205 | $I_V$       | 25   | 70       |      | mcd  |
| Dominant wavelength  | $I_F = 10\text{ mA}$          |          | $\lambda_d$ | 612  |          | 625  | nm   |
| Peak wavelength  | $I_F = 10\text{ mA}$          |          | $\lambda_p$ |      | 635      |      | nm   |
| Angle of half intensity  | $I_F = 10\text{ mA}$          |          | $\phi$      |      | $\pm 14$ |      | deg  |
| Forward voltage  | $I_F = 20\text{ mA}$          |          | $V_F$       |      | 2        | 3    | V    |
| Reverse voltage  | $I_R = 10\text{ }\mu\text{A}$ |          | $V_R$       | 6    | 15       |      | V    |
| Junction capacitance   | $V_R = 0, f = 1\text{ MHz}$   |          | $C_j$       |      | 50       |      | pF   |

Note:

<sup>1)</sup>  $T_{amb} = 25\text{ }^\circ\text{C}$ , unless otherwise specified

<sup>2)</sup> In one packing unit  $I_{Vmin.}/I_{Vmax.} \leq 0.5$

| OPTICAL AND ELECTRICAL CHARACTERISTICS <sup>1)</sup> TLHY520., YELLOW |                               |          |             |      |          |      |      |
|---|-------------------------------|----------|-------------|------|----------|------|------|
| PARAMETER   | TEST CONDITION                | PART     | SYMBOL      | MIN. | TYP.     | MAX. | UNIT |
| Luminous intensity <sup>2)</sup>                                      | $I_F = 10\text{ mA}$          | TLHY5200 | $I_V$       | 10   | 50       |      | mcd  |
| Dominant wavelength   | $I_F = 10\text{ mA}$          |          | $\lambda_d$ | 581  |          | 594  | nm   |
| Peak wavelength   | $I_F = 10\text{ mA}$          |          | $\lambda_p$ |      | 585      |      | nm   |
| Angle of half intensity   | $I_F = 10\text{ mA}$          |          | $\phi$      |      | $\pm 14$ |      | deg  |
| Forward voltage   | $I_F = 20\text{ mA}$          |          | $V_F$       |      | 2.4      | 3    | V    |
| Reverse voltage   | $I_R = 10\text{ }\mu\text{A}$ |          | $V_R$       | 6    | 15       |      | V    |
| Junction capacitance  | $V_R = 0, f = 1\text{ MHz}$   |          | $C_j$       |      | 50       |      | pF   |

Note:

<sup>1)</sup>  $T_{amb} = 25\text{ }^\circ\text{C}$ , unless otherwise specified

<sup>2)</sup> In one packing unit  $I_{Vmin.}/I_{Vmax.} \leq 0.5$

| OPTICAL AND ELECTRICAL CHARACTERISTICS <sup>1)</sup> TLHG520., GREEN |                              |          |             |      |          |      |      |
|--|------------------------------|----------|-------------|------|----------|------|------|
| PARAMETER  | TEST CONDITION               | PART     | SYMBOL      | MIN. | TYP.     | MAX. | UNIT |
| Luminous intensity <sup>2)</sup>                                     | $I_F = 10 \text{ mA}$        | TLHG5200 | $I_V$       | 16   | 40       |      | mcd  |
|  |                              | TLHG5201 | $I_V$       | 25   | 45       |      | mcd  |
|  |                              | TLHG5205 | $I_V$       | 40   | 50       |      | mcd  |
| Dominant wavelength  | $I_F = 10 \text{ mA}$        |          | $\lambda_d$ | 562  |          | 575  | nm   |
| Peak wavelength  | $I_F = 10 \text{ mA}$        |          | $\lambda_p$ |      | 565      |      | nm   |
| Angle of half intensity  | $I_F = 10 \text{ mA}$        |          | $\phi$      |      | $\pm 14$ |      | deg  |
| Forward voltage  | $I_F = 20 \text{ mA}$        |          | $V_F$       |      | 2.4      | 3    | V    |
| Reverse voltage  | $I_R = 10 \mu\text{A}$       |          | $V_R$       | 6    | 15       |      | V    |
| Junction capacitance   | $V_R = 0, f = 1 \text{ MHz}$ |          | $C_j$       |      | 50       |      | pF   |

Note:

<sup>1)</sup>  $T_{amb} = 25 \text{ }^\circ\text{C}$ , unless otherwise specified

<sup>2)</sup> In one packing unit  $I_{Vmin.}/I_{Vmax.} \leq 0.5$

## TYPICAL CHARACTERISTICS

$T_{amb} = 25 \text{ }^\circ\text{C}$ , unless otherwise specified



Figure 1. Forward Current vs. Ambient Temperature

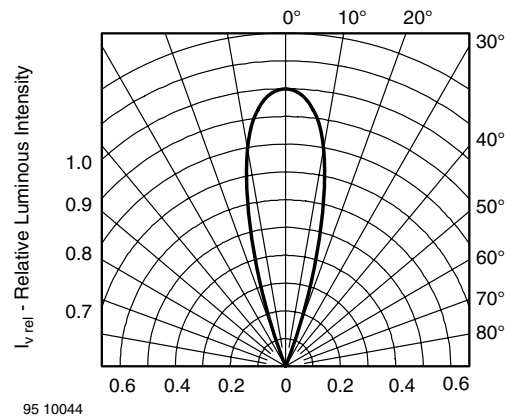

Figure 3. Rel. Luminous Intensity vs. Angular Displacement

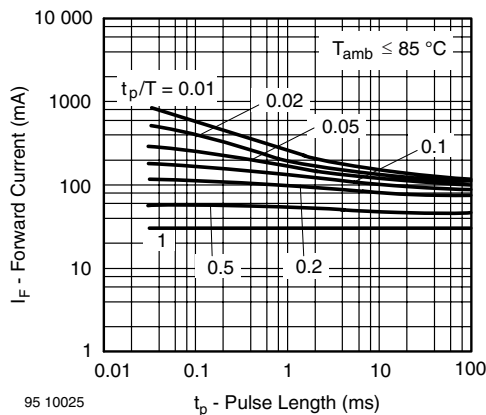

Figure 2. Forward Current vs. Pulse Length

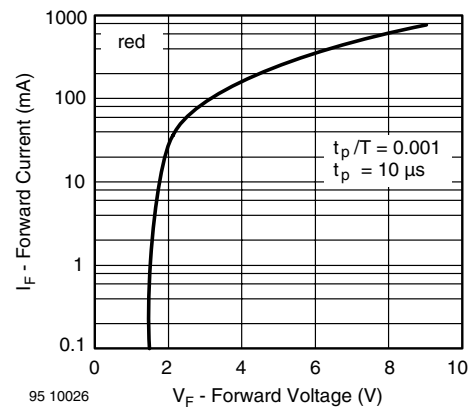

Figure 4. Forward Current vs. Forward Voltage



Figure 5. Rel. Luminous Intensity vs. Ambient Temperature



Figure 8. Relative Intensity vs. Wavelength



Figure 6. Rel. Lumin. Intensity vs. Forw. Current/Duty Cycle



Figure 9. Forward Current vs. Forward Voltage



Figure 7. Relative Luminous Intensity vs. Forward Current



Figure 10. Rel. Luminous Intensity vs. Ambient Temperature



Figure 11. Rel. Lumin. Intensity vs. Forw. Current/Duty Cycle



Figure 14. Forward Current vs. Forward Voltage



Figure 12. Relative Luminous Intensity vs. Forward Current



Figure 15. Rel. Luminous Intensity vs. Ambient Temperature

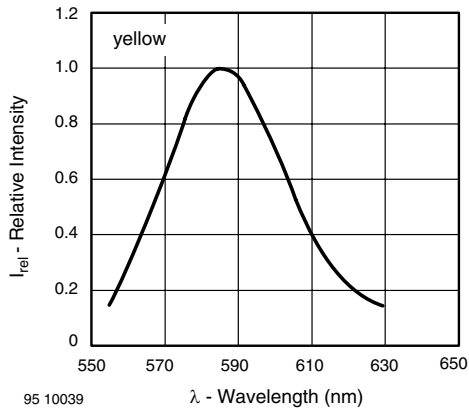

Figure 13. Relative Intensity vs. Wavelength

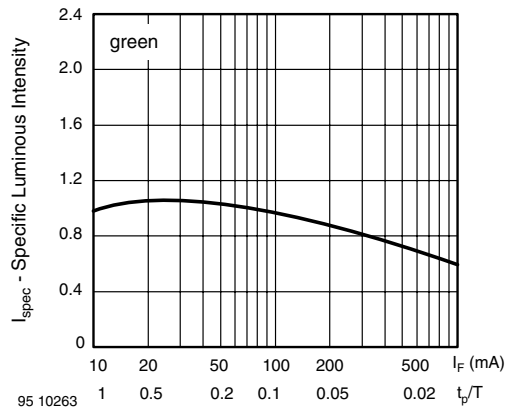

Figure 16. Specific Luminous Intensity vs. Forward Current



Figure 17. Relative Luminous Intensity vs. Forward Current



Figure 18. Relative Intensity vs. Wavelength

**PACKAGE DIMENSIONS** in millimeters



6.544-5258.01-4  
 Issue: 5; 19.05.09  
 96 12119

**REEL**



Figure 19. Reel Dimensions

AS12 = cathode leaves tape first  
AS21 = anode leaves tape first

**AMMOPACK**

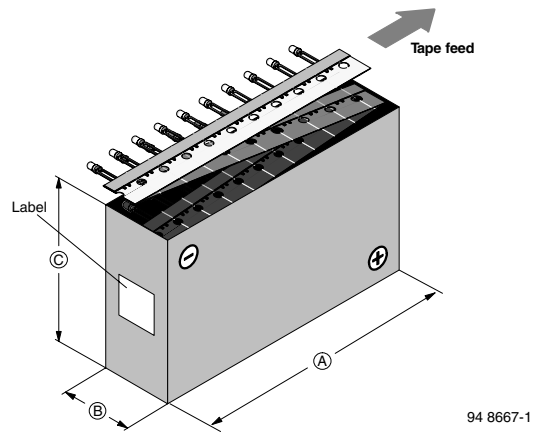

Figure 21. Tape Direction

Note:  
AS12Z and AS21Z still valid for already existing types BUT NOT FOR NEW DESIGN

**TAPE**

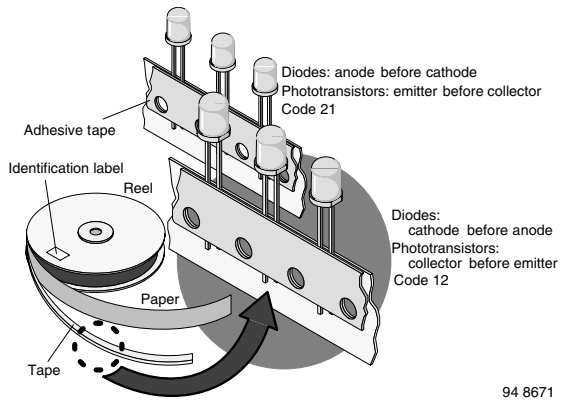

Figure 20. LED in Tape

## TAPE DIMENSIONS



|               |                         |
|---------------|-------------------------|
| Quantity per: | Reel<br>(Mat.-no. 1764) |
|               | 1000                    |

94 8172

|        |                   |
|--------|-------------------|
| Option | Dim. "H" ± 0.5 mm |
| AS     | 17.3              |





## Disclaimer

ALL PRODUCT, PRODUCT SPECIFICATIONS AND DATA ARE SUBJECT TO CHANGE WITHOUT NOTICE TO IMPROVE RELIABILITY, FUNCTION OR DESIGN OR OTHERWISE.

Vishay Intertechnology, Inc., its affiliates, agents, and employees, and all persons acting on its or their behalf (collectively, "Vishay"), disclaim any and all liability for any errors, inaccuracies or incompleteness contained in any datasheet or in any other disclosure relating to any product.

Vishay makes no warranty, representation or guarantee regarding the suitability of the products for any particular purpose or the continuing production of any product. To the maximum extent permitted by applicable law, Vishay disclaims (i) any and all liability arising out of the application or use of any product, (ii) any and all liability, including without limitation special, consequential or incidental damages, and (iii) any and all implied warranties, including warranties of fitness for particular purpose, non-infringement and merchantability.

Statements regarding the suitability of products for certain types of applications are based on Vishay's knowledge of typical requirements that are often placed on Vishay products in generic applications. Such statements are not binding statements about the suitability of products for a particular application. It is the customer's responsibility to validate that a particular product with the properties described in the product specification is suitable for use in a particular application. Parameters provided in datasheets and/or specifications may vary in different applications and performance may vary over time. All operating parameters, including typical parameters, must be validated for each customer application by the customer's technical experts. Product specifications do not expand or otherwise modify Vishay's terms and conditions of purchase, including but not limited to the warranty expressed therein.

Except as expressly indicated in writing, Vishay products are not designed for use in medical, life-saving, or life-sustaining applications or for any other application in which the failure of the Vishay product could result in personal injury or death. Customers using or selling Vishay products not expressly indicated for use in such applications do so at their own risk. Please contact authorized Vishay personnel to obtain written terms and conditions regarding products designed for such applications.

No license, express or implied, by estoppel or otherwise, to any intellectual property rights is granted by this document or by any conduct of Vishay. Product names and markings noted herein may be trademarks of their respective owners.

## Material Category Policy

**Vishay Intertechnology, Inc. hereby certifies that all its products that are identified as RoHS-Compliant fulfill the definitions and restrictions defined under Directive 2011/65/EU of The European Parliament and of the Council of June 8, 2011 on the restriction of the use of certain hazardous substances in electrical and electronic equipment (EEE) - recast, unless otherwise specified as non-compliant.**

**Please note that some Vishay documentation may still make reference to RoHS Directive 2002/95/EC. We confirm that all the products identified as being compliant to Directive 2002/95/EC conform to Directive 2011/65/EU.**

**Vishay Intertechnology, Inc. hereby certifies that all its products that are identified as Halogen-Free follow Halogen-Free requirements as per JEDEC JS709A standards. Please note that some Vishay documentation may still make reference to the IEC 61249-2-21 definition. We confirm that all the products identified as being compliant to IEC 61249-2-21 conform to JEDEC JS709A standards.**



## Стандарт Электрон Связь

Мы молодая и активно развивающаяся компания в области поставок электронных компонентов. Мы поставляем электронные компоненты отечественного и импортного производства напрямую от производителей и с крупнейших складов мира.

Благодаря сотрудничеству с мировыми поставщиками мы осуществляем комплексные и плановые поставки широчайшего спектра электронных компонентов.

Собственная эффективная логистика и склад в обеспечивает надежную поставку продукции в точно указанные сроки по всей России.

Мы осуществляем техническую поддержку нашим клиентам и предпродажную проверку качества продукции. На все поставляемые продукты мы предоставляем гарантию .

Осуществляем поставки продукции под контролем ВП МО РФ на предприятия военно-промышленного комплекса России , а также работаем в рамках 275 ФЗ с открытием отдельных счетов в уполномоченном банке. Система менеджмента качества компании соответствует требованиям ГОСТ ISO 9001.

Минимальные сроки поставки, гибкие цены, неограниченный ассортимент и индивидуальный подход к клиентам являются основой для выстраивания долгосрочного и эффективного сотрудничества с предприятиями радиоэлектронной промышленности, предприятиями ВПК и научно-исследовательскими институтами России.

С нами вы становитесь еще успешнее!

### Наши контакты:

**Телефон:** +7 812 627 14 35

**Электронная почта:** [sales@st-electron.ru](mailto:sales@st-electron.ru)

**Адрес:** 198099, Санкт-Петербург,  
Промышленная ул, дом № 19, литера Н,  
помещение 100-Н Офис 331