

***μ*IPM™-DIP**

**4.0Ω, 500V**

## Integrated Power Module for Small Appliance Motor Drive Applications

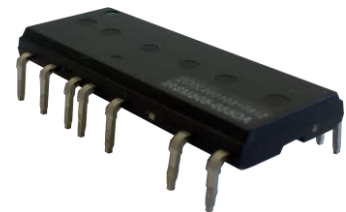
### Description

IRSM505-025 and IRSM515-025 are 3-phase Integrated Power Modules (IPM) designed for advanced appliance motor drive applications such as energy efficient fans and pumps. These advanced IPMs offers a combination of low  $R_{DS(on)}$  Trench FREDFET technology and the industry benchmark half-bridge high voltage, rugged driver in a familiar package. The modules are optimized for low EMI characteristics.

IRSM505-025 includes temperature feedback while IRSM515-025 does not.

### Features

- 500V 3-phase inverter including high voltage gate drivers
- Integrated bootstrap functionality
- Low 4.0Ω (max, 25°C)  $R_{DS(on)}$  Trench FREDFET
- Under-voltage lockout for all channels
- Matched propagation delay for all channels
- Temperature feedback via NTC (IRSM505-025 only)
- Optimized dV/dt for loss and EMI trade offs
- Open-source for single and leg-shunt current sensing
- 3.3V logic compatible and advanced input filter
- Driver tolerant to negative transient voltage (-Vs)
- Isolation 1900V<sub>RMS</sub>, 1min
- RoHS Compliant
- Certified by UL - File Number E252584



Base Part Number	NTC	Package Type	Standard Pack		Orderable Part Number
			Form	Quantity	
IRSM505-025	Yes	SOP23	Tube	240	IRSM505-025PA
		DIP23	Tube	240	IRSM505-025DA
		DIP23A	Tube	240	IRSM505-025DA2
IRSM515-025	No	SOP23	Tube	240	IRSM515-025PA
		DIP23	Tube	240	IRSM515-025DA
		DIP23A	Tube	240	IRSM515-025DA2
		DIP23C	Tube	240	IRSM515-025DA4

### Internal Electrical Schematic



### Absolute Maximum Ratings

Absolute maximum ratings indicate sustained limits beyond which damage to the module may occur. These are not tested at manufacturing. All voltage parameters are absolute voltages referenced to COM unless otherwise stated in the table.

Symbol	Description	Min	Max	Unit
$BV_{DSS}$	MOSFET Blocking Voltage	---	500	V
$I_o @ T_C=25^\circ C$	DC Output Current per MOSFET	---	1.5	A
$I_{OP} @ T_C =25^\circ C$	Pulsed Output Current per MOSFET (Note 1)	---	11	
$P_d @ T_C=25^\circ C$	Maximum Power Dissipation per MOSFET	---	18	W
$V_{ISO}$	Isolation Voltage (1min)	---	1900	$V_{RMS}$
$T_J$	Operating Junction Temperature	-40	150	$^\circ C$
$T_C$	Operating Case Temperature	-40	150	$^\circ C$
$T_S$	Storage Temperature	-40	150	$^\circ C$
$V_{S1,2,3}$	High Side Floating Supply Offset Voltage	$V_{B1,2,3} - 20$	$V_{B1,2,3} + 0.3$	V
$V_{B1,2,3}$	High Side Floating Supply Voltage	-0.3	525	V
$V_{CC}$	Low Side and Logic Supply voltage	-0.3	25	V
$V_{IN}$	Input Voltage of LIN, HIN	COM -0.3	$V_{CC} + 0.3$	V

Note 1: Pulse Width = 100 $\mu$ s, Single Pulse

### Recommended Operating Conditions

Symbol	Description	Min	Max	Unit
V+	Positive DC Bus Input Voltage	---	400	V
V <sub>S1,2,3</sub>	High Side Floating Supply Offset Voltage	(Note 2)	400	V
V <sub>B1,2,3</sub>	High Side Floating Supply Voltage	V <sub>S</sub> +12	V <sub>S</sub> +20	V
V <sub>CC</sub>	Low Side and Logic Supply Voltage	13.5	16.5	V
V <sub>IN</sub>	Input Voltage of LIN, HIN, I <sub>TRIP</sub> , EN, FLT	0	5	V
F <sub>p</sub>	PWM Carrier Frequency	---	20	kHz

Note 2: Logic operational for V<sub>s</sub> from COM-8V to COM+500V. Logic state held for V<sub>s</sub> from COM-8V to COM-V<sub>BS</sub>.

### Static Electrical Characteristics

(V<sub>CC</sub>-COM) = (V<sub>B</sub>-V<sub>S</sub>) = 15 V. T<sub>C</sub> = 25°C unless otherwise specified. The V<sub>IN</sub> and I<sub>IN</sub> parameters are referenced to COM and are applicable to all six channels. The V<sub>CCUV</sub> parameters are referenced to COM. The V<sub>BSUV</sub> parameters are referenced to V<sub>S</sub>.

Symbol	Description	Min	Typ	Max	Units	Conditions
BV <sub>DSS</sub>	Drain-to-Source Breakdown Voltage	500	---	---	V	T <sub>J</sub> =25°C, I <sub>LK</sub> =250μA
I <sub>LKH</sub>	Leakage Current of High Side FET		12		μA	T <sub>J</sub> =25°C, V <sub>DS</sub> =500V
I <sub>LKL</sub>	Leakage Current of Low Side FET Plus Gate Drive IC		14		μA	T <sub>J</sub> =25°C, V <sub>DS</sub> =500V
R <sub>DS(on)</sub>	Drain to Source ON Resistance	---	3.0	4.0	Ω	T <sub>J</sub> =25°C, V <sub>CC</sub> =15V, I <sub>d</sub> =0.5A
		---	7.6	---	Ω	T <sub>J</sub> =150°C, V <sub>CC</sub> =15V, I <sub>d</sub> =0.5A (Note 3)
V <sub>SD</sub>	Mosfet Body Diode Forward Voltage	---	0.8	---	V	T <sub>J</sub> =25°C, V <sub>CC</sub> =15V, I <sub>D</sub> =0.5A
V <sub>IN,th+</sub>	Positive Going Input Threshold	2.2	---	---	V	
V <sub>IN,th-</sub>	Negative Going Input Threshold	---	---	0.8	V	
V <sub>CCUV+</sub> , V <sub>BSUV+</sub>	V <sub>CC</sub> and V <sub>BS</sub> Supply Under-Voltage, Positive Going Threshold	8	8.9	9.8	V	
V <sub>CCUV-</sub> , V <sub>BSUV-</sub>	V <sub>CC</sub> and V <sub>BS</sub> supply Under-Voltage, Negative Going Threshold	6.9	7.7	8.5	V	
V <sub>CCUVH</sub> , V <sub>BSUVH</sub>	V <sub>CC</sub> and V <sub>BS</sub> Supply Under-Voltage Lock-Out Hysteresis	---	1.2	---	V	
I <sub>QBS</sub>	Quiescent V <sub>BS</sub> Supply Current V <sub>IN</sub> =0V	---	42	60	μA	
I <sub>QBS, ON</sub>	Quiescent V <sub>BS</sub> Supply Current V <sub>IN</sub> =4V	---	42	60	μA	
I <sub>QCC</sub>	Quiescent V <sub>CC</sub> Supply Current V <sub>IN</sub> =0V	---	1.7	4	mA	
I <sub>QCC, ON</sub>	Quiescent V <sub>CC</sub> Supply Current V <sub>IN</sub> =4V	---	1.8	4	mA	
I <sub>IN+</sub>	Input Bias Current V <sub>IN</sub> =4V	---	5.9	18	μA	V <sub>IN</sub> =3.3V
I <sub>IN-</sub>	Input Bias Current V <sub>IN</sub> =0V	---	---	2	μA	V <sub>IN</sub> =0V
R <sub>BR</sub>	Internal Bootstrap Equivalent Resistor Value	---	250	---	Ω	T <sub>J</sub> =25°C

Note 3: Characterized, not tested at manufacturing

### Dynamic Electrical Characteristics

$(V_{CC-COM}) = (V_B - V_S) = 15\text{ V}$ .  $T_C = 25^\circ\text{C}$  unless otherwise specified.

Symbol	Description	Min	Typ	Max	Units	Conditions
$T_{ON}$	Input to Output Propagation Turn-On Delay Time	---	0.8	1.5	$\mu\text{s}$	$I_D=120\text{mA}$ , $V_+=30\text{V}$ See Fig.1
$T_{OFF}$	Input to Output Propagation Turn-Off Delay Time	---	0.9	1.5	$\mu\text{s}$	
$T_{FIL,IN}$	Input Filter Time (HIN, LIN)	200	300	---	ns	$V_{IN}=0$ & $V_{IN}=3.3\text{V}$
DT	Deadtime Inserted	---	400	---	ns	$V_{IN}=0$ & $V_{IN}=3.3\text{V}$ without external deadtime
$E_{ON}$	Turn-on switching energy loss	---	25	---	$\mu\text{J}$	$V_i=320\text{V}$ , $I_D=0.5\text{A}$ , $L=40\text{mH}$ , $T_C=25^\circ\text{C}$ (Note 4)
$E_{OFF}$	Turn-off switching energy loss	---	5	---	$\mu\text{J}$	
$E_{REC}$	Recovery energy loss	---	5	---	$\mu\text{J}$	
$E_{ON,150}$	Turn-on switching energy loss	---	42	---	$\mu\text{J}$	$V_i=320\text{V}$ , $I_D=0.5\text{A}$ , $L=40\text{mH}$ , $T_C=150^\circ\text{C}$ (Note 4)
$E_{OFF,150}$	Turn-off switching energy loss	---	6	---	$\mu\text{J}$	
$E_{REC,150}$	Recovery energy loss	---	10	---	$\mu\text{J}$	

Note 4: Characterized, not tested at manufacturing

### Thermal and Mechanical Characteristics

Symbol	Description	Min	Typ	Max	Units	Conditions
$R_{th(J-C)}$	Junction to Case Thermal Resistance	---	7.0	---	$^\circ\text{C/W}$	High Side V-Phase Mosfet (Note 5)

Note 5: Characterized, not tested at manufacturing. Case temperature ( $T_C$ ) point shown in Figure 2.

### Internal NTC – Thermistor Characteristics (IRSM505-025 Only)

Symbol	Description	Min	Typ	Max	Units	Conditions
$R_{25}$	Resistance	---	47	---	k $\Omega$	$T_C=25^\circ\text{C}$ , $\pm 5\%$ tolerance
$R_{125}$	Resistance	---	1.41	---	k $\Omega$	$T_C=125^\circ\text{C}$
B	B-constant (25-50 $^\circ\text{C}$ )	---	4050	---	K	$\pm 2\%$ tolerance (Note 6)
Temperature Range		-40	---	125	$^\circ\text{C}$	

Note 6: See application notes for usage

**Qualification Information†**

<b>Qualification Level</b>		Industrial <sup>††</sup>
<b>Moisture Sensitivity Level</b>		MSL3 <sup>†††</sup>
<b>RoHS Compliant</b>		Yes
<b>UL Certified</b>		Yes – File Number E252584
<b>ESD</b>	<b>Machine Model</b>	Class B
	<b>Human Body Model</b>	Class 2

† Qualification standards can be found at International Rectifier’s web site <http://www.irf.com/>

†† Higher qualification ratings may be available should the user have such requirements. Please contact your International Rectifier sales representative for further information.

††† SOP23 package only. Higher MSL ratings may be available for the specific package types listed here. Please contact your International Rectifier sales representative for further information.

**Module Pin-Out Description**

Pin	Name	Description
1	COM	Logic Ground
2	V <sub>B1</sub>	High Side Floating Supply Voltage 1
3	V <sub>CC1</sub>	15V Supply 1
4	HIN1	Logic Input for High Side Gate Driver - Phase 1
5	LIN1	Logic Input for Low Side Gate Driver - Phase 1
6	NC	Not Connected
7	V <sub>B2</sub>	High Side Floating Supply Voltage 2
8	V <sub>CC2</sub>	15V Supply 2
9	HIN2	Logic Input for High Side Gate Driver - Phase 2
10	LIN2	Logic Input for Low Side Gate Driver - Phase 2
11	V <sub>TH</sub>	Thermistor Output (IRSM505-025DA)
	NC	Not Connected (IRSM515-025DA)
12	V <sub>B3</sub>	High Side Floating Supply Voltage 3
13	V <sub>CC3</sub>	15V Supply 3
14	HIN3	Logic Input for High Side Gate Driver - Phase 3
15	LIN3	Logic Input for Low Side Gate Driver - Phase 3
16	NC	Not Connected
17	V+	DC Bus Voltage Positive
18	U/V <sub>S1</sub>	Output - Phase 1, High Side Floating Supply Offset 1
19	V <sub>R1</sub>	Phase 1 Low Side Source
20	V <sub>R2</sub>	Phase 2 Low Side Source
21	V/V <sub>S2</sub>	Output - Phase 2, High Side Floating Supply Offset 2
22	V <sub>R3</sub>	Phase 3 Low Side Source
23	W/V <sub>S3</sub>	Output - Phase 3, High Side Floating Supply Offset 2



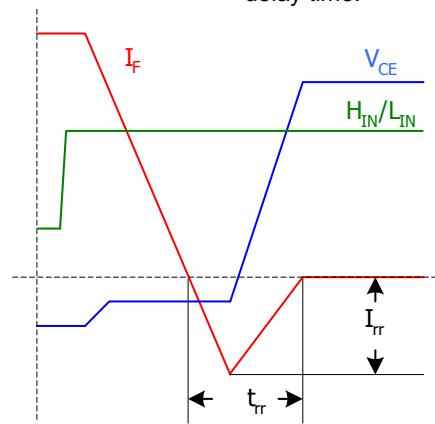
**Referenced Figures**



**Figure 1a:** Input to Output propagation turn-on delay time.

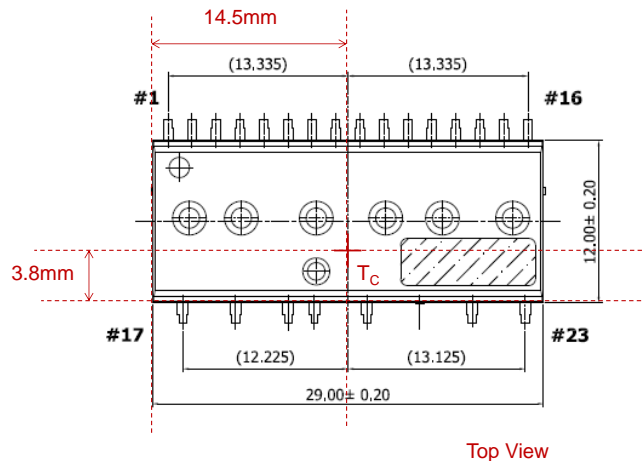


**Figure 1b:** Input to Output propagation turn-off delay time.



**Figure 1c:** Diode Reverse Recovery.

**Figure 1:** Switching Parameter Definitions



Top View

**Figure 2:**  $T_C$  measurement point for  $R_{th(j-c)}$

### Application Notes

A basic application schematic is shown below.



**Figure 3:** Basic sensor-less motor drive circuit connection. Motor is connected to U, V, W

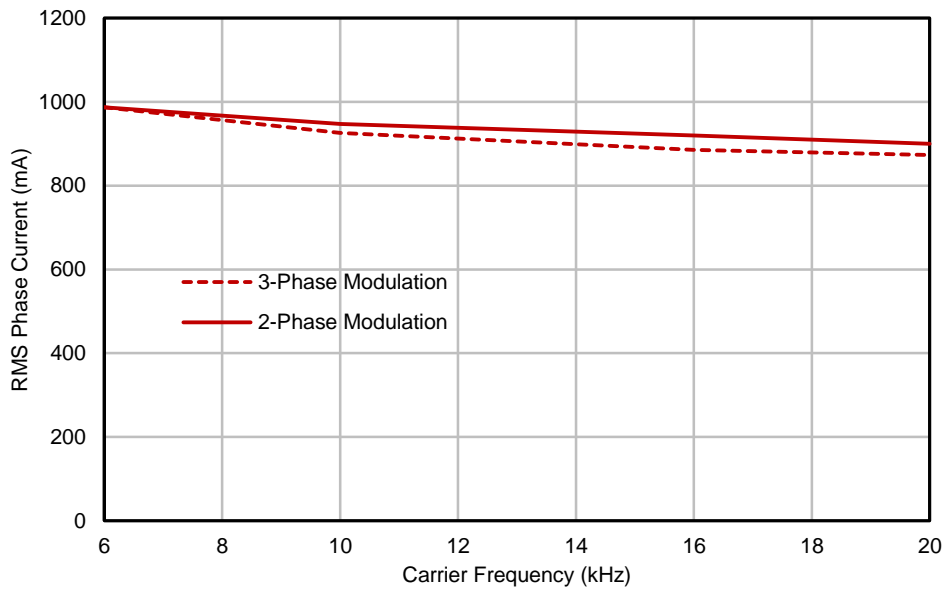
A complete reference design board for running any permanent magnet motor via sensorless sinusoidal control is available. The board – photo below – features the  $\mu$ IPM™-DIP module and the iMotion™ digital control IC. Reference design kits are available on the [International Rectifier website](http://www.irf.com) (irf.com > Design Resources > Reference Designs > Intelligent Power Modules)



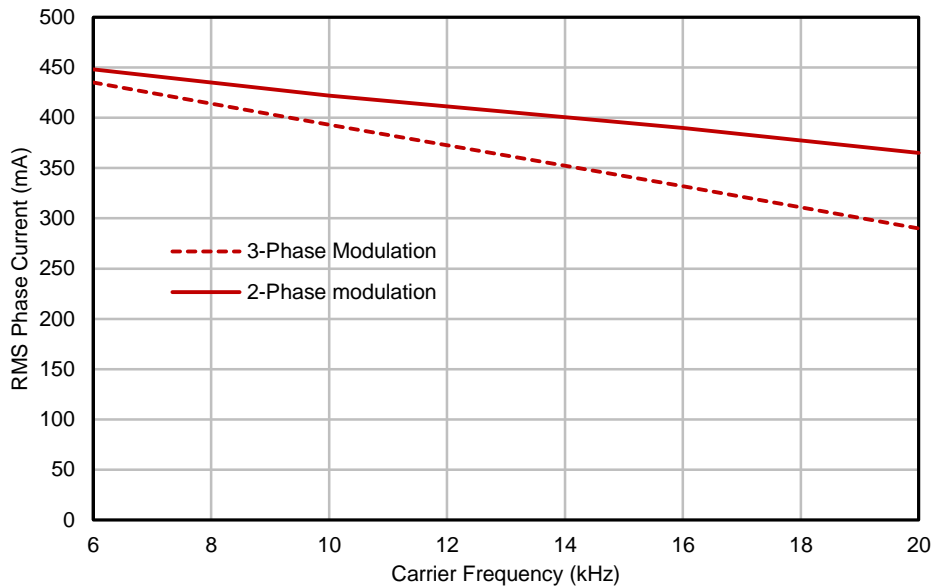
**Figure 4:** Reference design board featuring the  $\mu$ IPM™-DIP module and the iMotion™ IRMCF171 digital control IC



Figures 5-7 show the typical current capability for this module at specified conditions. In all tests, the application board – the IRMCS1071-1-D reference board – was placed in a box to prevent cooling from ambient airflow. Figure 5 is derived from using a heat sink that maintains  $T_C$  at 125°C. Figures 6-7 represent current capability for the module as used without any heat sink.  $\Delta T_{JA}$  represents the difference in temperature between the junction of the high-side V-phase Mosfet and the ambient, measured 10cm above and 6cm away from the board. Ambient temperature kept within 28-29°C.



**Figure 5:** Maximum sinusoidal phase current vs PWM switching frequency with a heat sink. Space Vector Modulation,  $V_+ = 320V$ ,  $T_A = 28^\circ C$ ,  $T_J = 150^\circ C$ ,  $T_C = 125^\circ C$



**Figure 6:** Maximum sinusoidal phase current vs PWM switching frequency, no heat sink. Space Vector Modulation,  $V_+ = 320V$ ,  $T_A = 28^\circ C$ ,  $T_J = 128^\circ C$



**Figure 7:** Maximum sinusoidal phase current vs PWM switching frequency, no heat sink. Space Vector Modulation,  $V_+ = 320V$ ,  $T_A = 28^\circ C$ ,  $T_J = 98^\circ C$

The module contains an NTC – connected between COM and the  $V_{TH}$  pin – which can be used to monitor the temperature of the module. The NTC is effectively a resistor whose value decreases as the temperature rises. The NTC resistance can be calculated at any temperature as follows:

$$R_{TH} = R_{25} e^{\left[ B \left( \frac{1}{T_{TH}} - \frac{1}{T_{25}} \right) \right]}$$

, where  $R_{25}$  is 47k $\Omega$  and  $B$  is 4050K

An external resistor network is connected to the NTC, the simplest of which is one resistor pulled up to  $V_{CC}$  as shown in Figure 3. The  $V_{TH}$  vs NTC temperature,  $T_{TH}$  curve for this configuration is shown in Figure 8 below. The min, typical and max curves result from the NTC having a  $\pm 5\%$  tolerance on its resistance and  $\pm 2\%$  tolerance on the B-parameter.

Figure 9 shows the thermistor temperature,  $T_{TH}$  plotted against the high-side V-phase junction temperature,  $T_J$  for a module without a heat sink. It is thus advisable to shut down the module when  $T_{TH}$  reaches 125 $^\circ C$ .



**Figure 8:**  $V_{TH}$  vs  $T_{TH}$  with  $V_{TH}$  pin pulled up to  $V_{CC}$  with a 7.50k $\Omega$  (1%, 100ppm) resistor. A 15V, 1% variation in  $V_{CC}$  is assumed.



**Figure 9:**  $T_{TH}$  vs  $T_J$  for a module without a heat sink.  $V_{CC}=15.3V$ ,  $R=7.50k\Omega$

**SOP23 Package Outline**



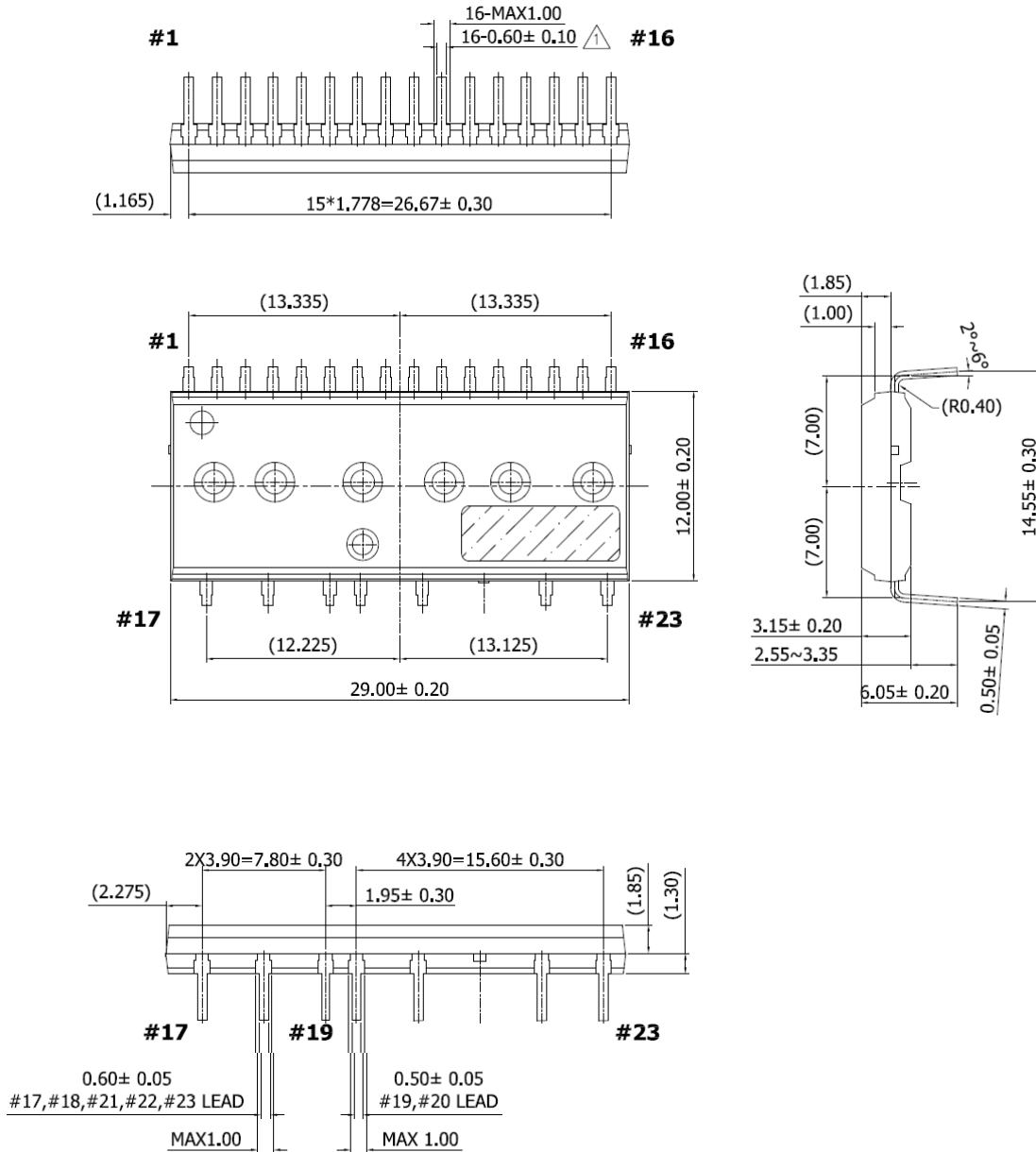
Dimensions in mm

**DIP23A Package Outline**



Dimensions in mm

**DIP23 Package Outline**



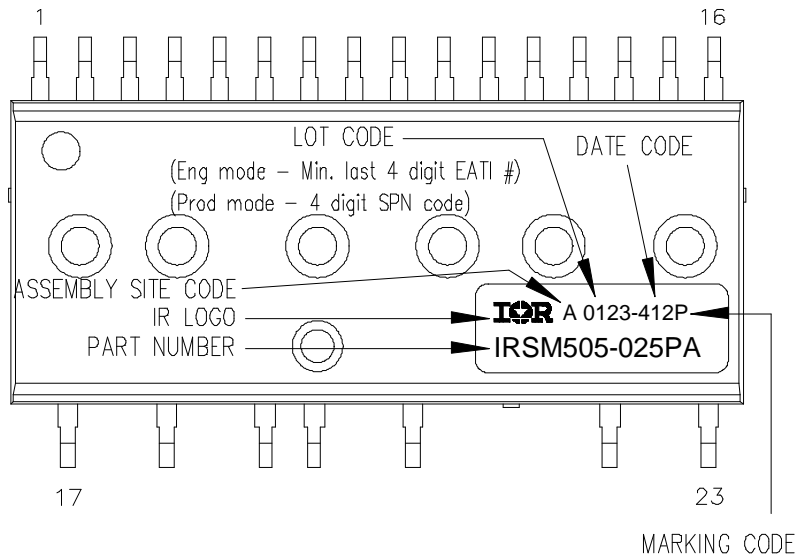
Dimensions in mm

**DIP23C Package Outline**



Dimensions in mm

**Top Marking**



**Marking Code** P = Pb Free; Y = Engineering Samples

**Date Code** YWW format, where Y = least significant digit of the production year , WW = two digits representing the week of the production year

**Revision History**

- July 23, 2014 Corrected Figure 1, showing positive logic. Added DIP23C package option
- Nov 2014 Added UL certification note





## Стандарт Электрон Связь

Мы молодая и активно развивающаяся компания в области поставок электронных компонентов. Мы поставляем электронные компоненты отечественного и импортного производства напрямую от производителей и с крупнейших складов мира.

Благодаря сотрудничеству с мировыми поставщиками мы осуществляем комплексные и плановые поставки широчайшего спектра электронных компонентов.

Собственная эффективная логистика и склад в обеспечивает надежную поставку продукции в точно указанные сроки по всей России.

Мы осуществляем техническую поддержку нашим клиентам и предпродажную проверку качества продукции. На все поставляемые продукты мы предоставляем гарантию .

Осуществляем поставки продукции под контролем ВП МО РФ на предприятия военно-промышленного комплекса России , а также работаем в рамках 275 ФЗ с открытием отдельных счетов в уполномоченном банке. Система менеджмента качества компании соответствует требованиям ГОСТ ISO 9001.

Минимальные сроки поставки, гибкие цены, неограниченный ассортимент и индивидуальный подход к клиентам являются основой для выстраивания долгосрочного и эффективного сотрудничества с предприятиями радиоэлектронной промышленности, предприятиями ВПК и научно-исследовательскими институтами России.

С нами вы становитесь еще успешнее!

### Наши контакты:

**Телефон:** +7 812 627 14 35

**Электронная почта:** [sales@st-electron.ru](mailto:sales@st-electron.ru)

**Адрес:** 198099, Санкт-Петербург,  
Промышленная ул, дом № 19, литера Н,  
помещение 100-Н Офис 331