

## Dual Common-Cathode Schottky Rectifier

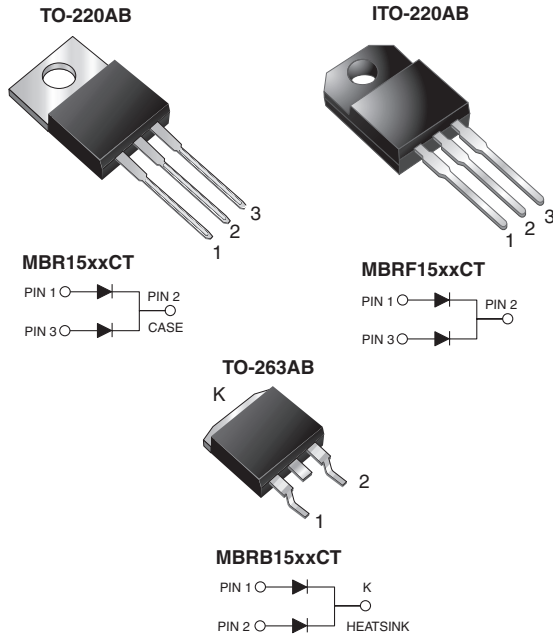

### FEATURES

- Guardring for overvoltage protection
- Lower power losses, high efficiency
- Low forward voltage drop
- High forward surge capability
- High frequency operation
- Meets MSL level 1, per J-STD-020, LF maximum peak of 245 °C (for TO-263AB package)
- Solder dip 260 °C, 40 s (for TO-220AB and ITO-220AB package)
- Component in accordance to RoHS 2002/95/EC and WEEE 2002/96/EC



**RoHS**  
COMPLIANT

### TYPICAL APPLICATIONS

For use in high frequency rectifier of switching mode power supplies, freewheeling diodes, dc-to-dc converters or polarity protection application.

### MECHANICAL DATA

**Case:** TO-220AB, ITO-220AB, TO-263AB

Epoxy meets UL 94V-0 flammability rating

**Terminals:** Matte tin plated leads, solderable per J-STD-002 and JESD22-B102

E3 suffix for consumer grade, meets JESD 201 class 1A whisker test, HE3 suffix for high reliability grade (AEC Q101 qualified), meets JESD 201 class 2 whisker test

**Polarity:** As marked

**Mounting Torque:** 10 in-lbs maximum

### PRIMARY CHARACTERISTICS

$I_{F(AV)}$	7.5 A x 2
$V_{RRM}$	35 V to 60 V
$I_{FSM}$	150 A
$V_F$	0.57 V, 0.65 V
$T_J \text{ max.}$	150 °C

### MAXIMUM RATINGS ( $T_C = 25 \text{ °C}$ unless otherwise noted)

PARAMETER	SYMBOL	MBR1535CT	MBR1545CT	MBR1550CT	MBR1560CT	UNIT
Maximum repetitive peak reverse voltage	$V_{RRM}$	35	45	50	60	V
Working peak reverse voltage	$V_{RWM}$	35	45	50	60	V
Maximum DC blocking voltage	$V_{DC}$	35	45	50	60	V
Maximum average forward rectified current at $T_C = 105 \text{ °C}$	$I_{F(AV)}$	total device per diode		15		A
Peak forward surge current 8.3 ms single half sine-wave superimposed on rated load per diode	$I_{FSM}$			7.5		A
Peak repetitive reverse surge current per diode at $t_p = 2.0 \text{ }\mu\text{s}$ , 1 kHz	$I_{RRM}$			150		A
Peak repetitive reverse surge current per diode at $t_p = 2.0 \text{ }\mu\text{s}$ , 1 kHz	$I_{RRM}$	1.0		0.5		A
Voltage rate of change (rated $V_R$ )	dV/dt			10 000		V/ $\mu\text{s}$
Operating junction temperature range	$T_J$			- 65 to + 150		°C

# MBR(F,B)1535CT thru MBR(F,B)1560CT

Vishay General Semiconductor



MAXIMUM RATINGS (T <sub>C</sub> = 25 °C unless otherwise noted)						
PARAMETER	SYMBOL	MBR1535CT	MBR1545CT	MBR1550CT	MBR1560CT	UNIT
Storage temperature range	T <sub>STG</sub>	- 65 to + 175				°C
Isolation voltage (ITO-220AB only) from terminal to heatsink t = 1 min	V <sub>AC</sub>	1500				V

ELECTRICAL CHARACTERISTICS (T <sub>C</sub> = 25 °C unless otherwise noted)								
PARAMETER	TEST CONDITIONS		SYMBOL	MBR1535CT	MBR1545CT	MBR1550CT	MBR1560CT	UNIT
Maximum instantaneous forward voltage per diode <sup>(1)</sup>	I <sub>F</sub> = 7.5 A	T <sub>C</sub> = 25 °C	V <sub>F</sub>	-	-	0.75	-	V
	I <sub>F</sub> = 7.5 A	T <sub>C</sub> = 125 °C		0.57	-	0.65	-	
	I <sub>F</sub> = 15 A	T <sub>C</sub> = 25 °C		0.84	-	-	-	
	I <sub>F</sub> = 15 A	T <sub>C</sub> = 125 °C		0.72	-	-	-	
Maximum instantaneous reverse current at rated DC blocking voltage per diode <sup>(1)</sup>	T <sub>C</sub> = 25 °C		I <sub>R</sub>	0.1	-	1.0	-	mA
	T <sub>C</sub> = 125 °C			15	-	50	-	

**Note:**

(1) Pulse test: 300 μs pulse width, 1 % duty cycle

THERMAL CHARACTERISTICS (T <sub>C</sub> = 25 °C unless otherwise noted)					
PARAMETER	SYMBOL	MBR	MBRF	MBRB	UNIT
Maximum thermal resistance per diode	R <sub>θJA</sub>	60	-	60	°C/W
	R <sub>θJC</sub>	3.0	5.0	3.0	

ORDERING INFORMATION (Example)					
PACKAGE	PREFERRED P/N	UNIT WEIGHT (g)	PACKAGE CODE	BASE QUANTITY	DELIVERY MODE
TO-220AB	MBR1545CT-E3/45	1.85	45	50/tube	Tube
ITO-220AB	MBRF1545CT-E3/45	1.99	45	50/tube	Tube
TO-263AB	MBRB1545CT-E3/45	1.35	45	50/tube	Tube
TO-263AB	MBRB1545CT-E3/81	1.35	81	800/reel	Tape reel
TO-220AB	MBR1545CTHE3/45 <sup>(1)</sup>	1.85	45	50/tube	Tube
ITO-220AB	MBRF1545CTHE3/45 <sup>(1)</sup>	1.99	45	50/tube	Tube
TO-263AB	MBRB1545CTHE3/45 <sup>(1)</sup>	1.35	45	50/tube	Tube
TO-263AB	MBRB1545CTHE3/81 <sup>(1)</sup>	1.35	81	800/reel	Tape reel

**Note:**

(1) Automotive grade AEC Q101 qualified



## RATINGS AND CHARACTERISTICS CURVES

( $T_A = 25\text{ }^\circ\text{C}$  unless otherwise noted)

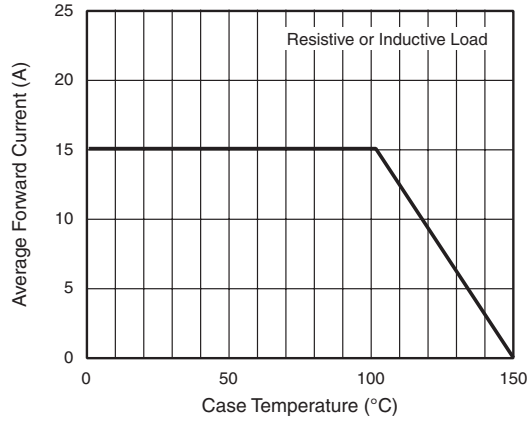

Figure 1. Forward Current Derating Curve

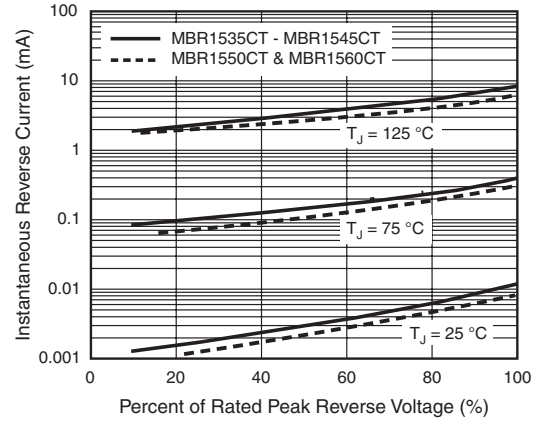

Figure 4. Typical Reverse Characteristics Per Diode

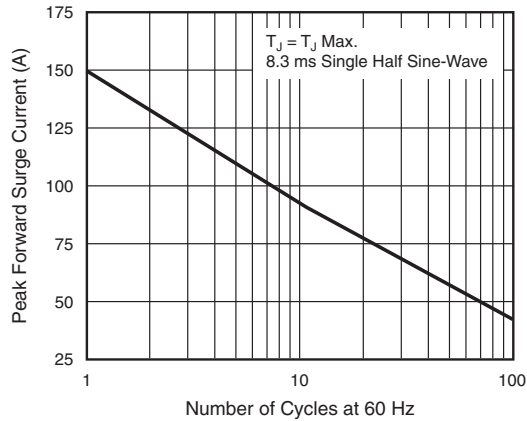

Figure 2. Maximum Non-Repetitive Peak Forward Surge Current Per Diode

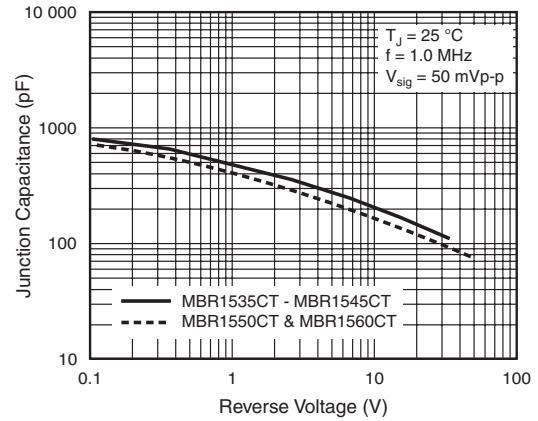

Figure 5. Typical Junction Capacitance Per Diode

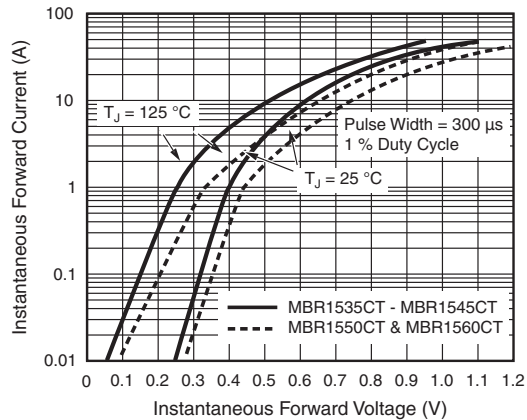

Figure 3. Typical Instantaneous Forward Characteristics Per Diode

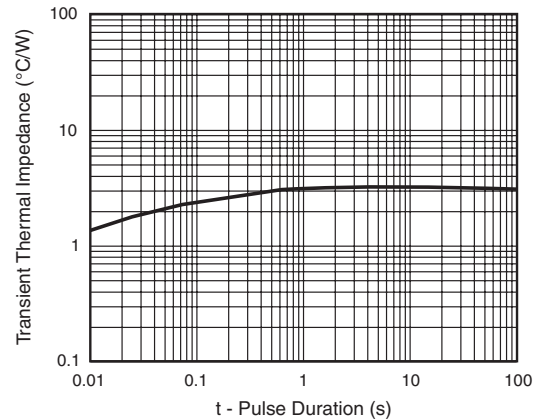

Figure 6. Typical Transient Thermal Impedance Per Diode

# MBR(F,B)1535CT thru MBR(F,B)1560CT

Vishay General Semiconductor



## PACKAGE OUTLINE DIMENSIONS in inches (millimeters)

TO-220AB

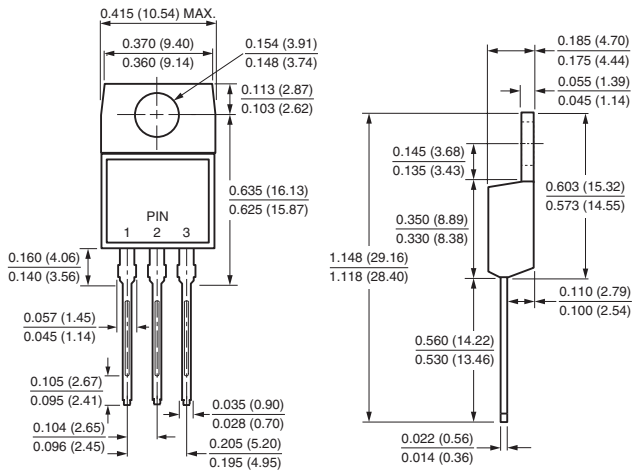

ITO-220AB

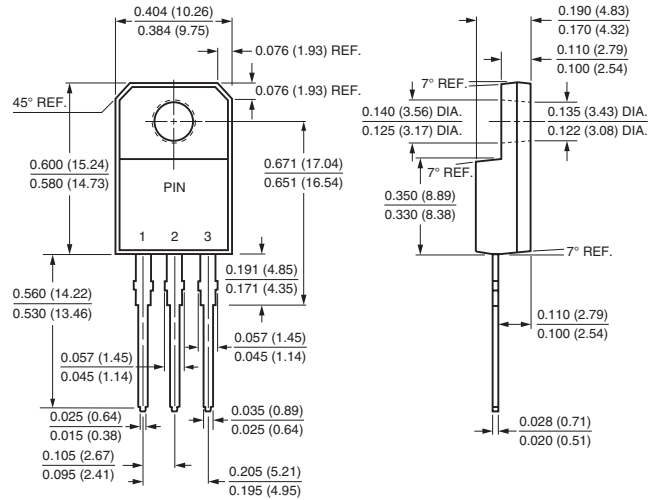

TO-263AB

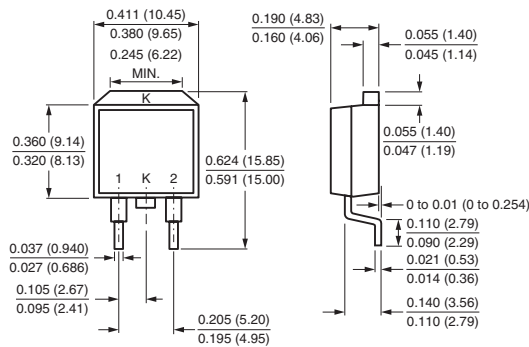

Mounting Pad Layout

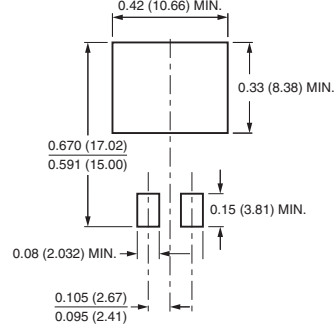



## Disclaimer

ALL PRODUCT, PRODUCT SPECIFICATIONS AND DATA ARE SUBJECT TO CHANGE WITHOUT NOTICE TO IMPROVE RELIABILITY, FUNCTION OR DESIGN OR OTHERWISE.

Vishay Intertechnology, Inc., its affiliates, agents, and employees, and all persons acting on its or their behalf (collectively, "Vishay"), disclaim any and all liability for any errors, inaccuracies or incompleteness contained in any datasheet or in any other disclosure relating to any product.

Vishay makes no warranty, representation or guarantee regarding the suitability of the products for any particular purpose or the continuing production of any product. To the maximum extent permitted by applicable law, Vishay disclaims (i) any and all liability arising out of the application or use of any product, (ii) any and all liability, including without limitation special, consequential or incidental damages, and (iii) any and all implied warranties, including warranties of fitness for particular purpose, non-infringement and merchantability.

Statements regarding the suitability of products for certain types of applications are based on Vishay's knowledge of typical requirements that are often placed on Vishay products in generic applications. Such statements are not binding statements about the suitability of products for a particular application. It is the customer's responsibility to validate that a particular product with the properties described in the product specification is suitable for use in a particular application. Parameters provided in datasheets and/or specifications may vary in different applications and performance may vary over time. All operating parameters, including typical parameters, must be validated for each customer application by the customer's technical experts. Product specifications do not expand or otherwise modify Vishay's terms and conditions of purchase, including but not limited to the warranty expressed therein.

Except as expressly indicated in writing, Vishay products are not designed for use in medical, life-saving, or life-sustaining applications or for any other application in which the failure of the Vishay product could result in personal injury or death. Customers using or selling Vishay products not expressly indicated for use in such applications do so at their own risk and agree to fully indemnify and hold Vishay and its distributors harmless from and against any and all claims, liabilities, expenses and damages arising or resulting in connection with such use or sale, including attorneys fees, even if such claim alleges that Vishay or its distributor was negligent regarding the design or manufacture of the part. Please contact authorized Vishay personnel to obtain written terms and conditions regarding products designed for such applications.

No license, express or implied, by estoppel or otherwise, to any intellectual property rights is granted by this document or by any conduct of Vishay. Product names and markings noted herein may be trademarks of their respective owners.



## Стандарт Электрон Связь

Мы молодая и активно развивающаяся компания в области поставок электронных компонентов. Мы поставляем электронные компоненты отечественного и импортного производства напрямую от производителей и с крупнейших складов мира.

Благодаря сотрудничеству с мировыми поставщиками мы осуществляем комплексные и плановые поставки широчайшего спектра электронных компонентов.

Собственная эффективная логистика и склад в обеспечивает надежную поставку продукции в точно указанные сроки по всей России.

Мы осуществляем техническую поддержку нашим клиентам и предпродажную проверку качества продукции. На все поставляемые продукты мы предоставляем гарантию .

Осуществляем поставки продукции под контролем ВП МО РФ на предприятия военно-промышленного комплекса России , а также работаем в рамках 275 ФЗ с открытием отдельных счетов в уполномоченном банке. Система менеджмента качества компании соответствует требованиям ГОСТ ISO 9001.

Минимальные сроки поставки, гибкие цены, неограниченный ассортимент и индивидуальный подход к клиентам являются основой для выстраивания долгосрочного и эффективного сотрудничества с предприятиями радиоэлектронной промышленности, предприятиями ВПК и научно-исследовательскими институтами России.

С нами вы становитесь еще успешнее!

### Наши контакты:

**Телефон:** +7 812 627 14 35

**Электронная почта:** [sales@st-electron.ru](mailto:sales@st-electron.ru)

**Адрес:** 198099, Санкт-Петербург,  
Промышленная ул, дом № 19, литера Н,  
помещение 100-Н Офис 331