



SANYO Semiconductors

DATA SHEET

An ON Semiconductor Company

2SC5490A — NPN Epitaxial Planar Silicon Transistor UHF to S-Band Low-Noise Amplifier Applications

Features

- Low-noise : NF=0.9dB typ (f=1GHz)
: NF=1.4dB typ (f=1.5GHz)
- Low-voltage, low-current operation (V_{CE}=1V, I_C=1mA)
: f_T=3.5GHz typ
: |S_{21e}|²=5.5dB typ (f=1.5GHz)
- High gain : |S_{21e}|²=10dB typ (f=1.5GHz)
- High cut-off frequency : f_T=8GHz typ
- Ultrasmall, slim flat-lead package (1.4mm×0.8mm×0.6mm)
- Halogen free compliance

Specifications

Absolute Maximum Ratings at Ta=25°C

Parameter	Symbol	Conditions	Ratings	Unit
Collector-to-Base Voltage	V _{CBO}		20	V
Collector-to-Emitter Voltage	V _{CEO}		10	V
Emitter-to-Base Voltage	V _{EBO}		1.5	V
Collector Current	I _C		30	mA
Collector Dissipation	PC		100	mW
Junction Temperature	T _j		150	°C
Storage Temperature	T _{stg}		-55 to +150	°C

This product is designed to "ESD immunity < 200V**", so please take care when handling.

* Machine Model

Package Dimensions

unit : mm (typ)

7029A-002

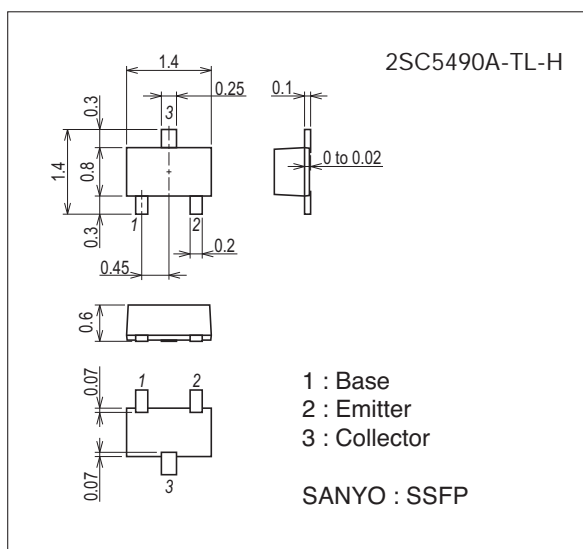

Product & Package Information

- Package : SSFP
- JEITA, JEDEC : SC-81
- Minimum Packing Quantity : 8,000 pcs./reel

Packing Type: TL

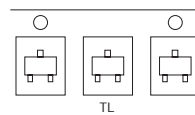

Marking

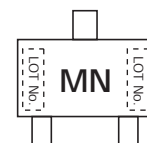

Electrical Connection

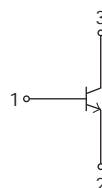

2SC5490A

Electrical Characteristics at Ta=25°C

Parameter	Symbol	Conditions	Ratings			Unit
			min	typ	max	
Collector Cutoff Current	I_{CBO}	$V_{CB}=10V, I_E=0A$			1.0	μA
Emitter Cutoff Current	I_{EBO}	$V_{EB}=1V, I_C=0A$			10	μA
DC Current Gain	h_{FE}	$V_{CE}=5V, I_C=10mA$	90		200	
Gain-Bandwidth Product	f_T1	$V_{CE}=5V, I_C=10mA$	5	8		GHz
	f_T2	$V_{CE}=1V, I_C=1mA$		3.5		GHz
Output Capacitance	C_{ob}	$V_{CB}=10V, f=1MHz$		0.45	0.7	pF
Reverse Transfer Capacitance	C_{re}			0.3		pF
Forward Transfer Gain	$ S_{21e} ^{21}$	$V_{CE}=5V, I_C=10mA, f=1.5GHz$	8	10		dB
	$ S_{21e} ^{22}$	$V_{CE}=1V, I_C=1mA, f=1.5GHz$		5.5		dB
Noise Figure	NF1	$V_{CE}=5V, I_C=5mA, f=1.5GHz$		1.4	3.0	dB
	NF2	$V_{CE}=2V, I_C=3mA, f=1GHz$		0.9		dB

Ordering Information

Device	Package	Shipping	memo
2SC5490A-TL-H	SSFP	8,000pcs./reel	Pb Free and Halogen Free

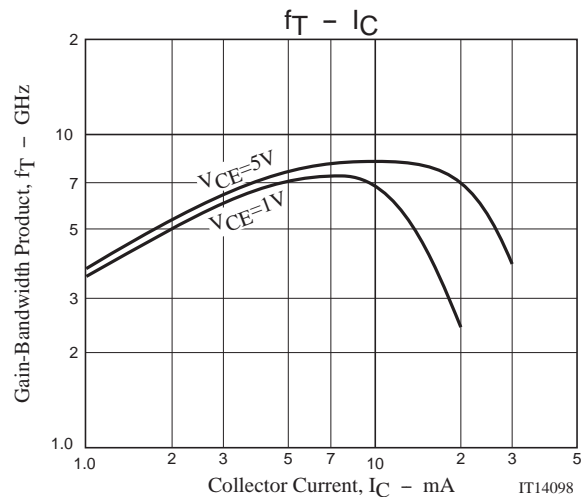
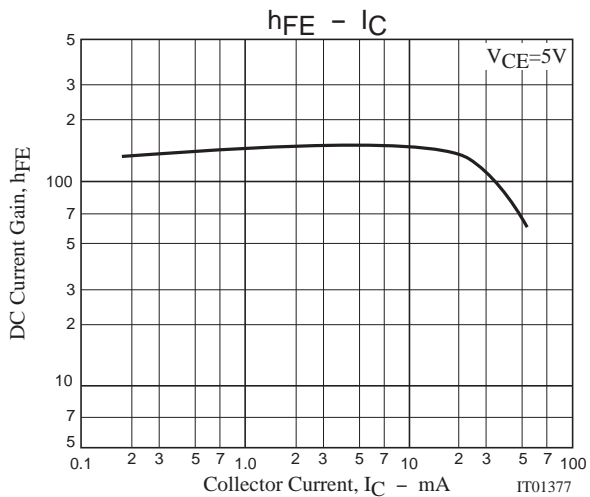

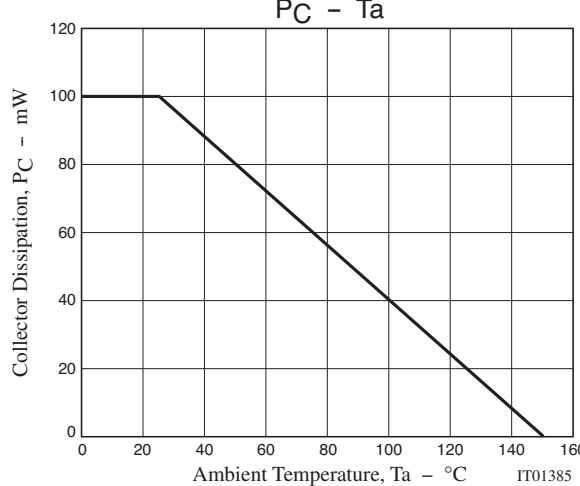
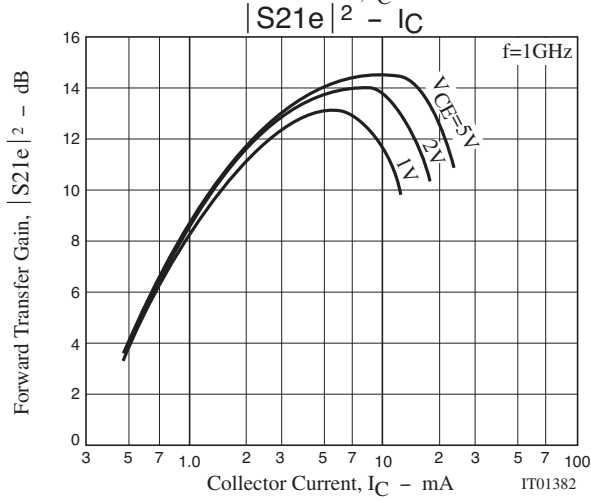
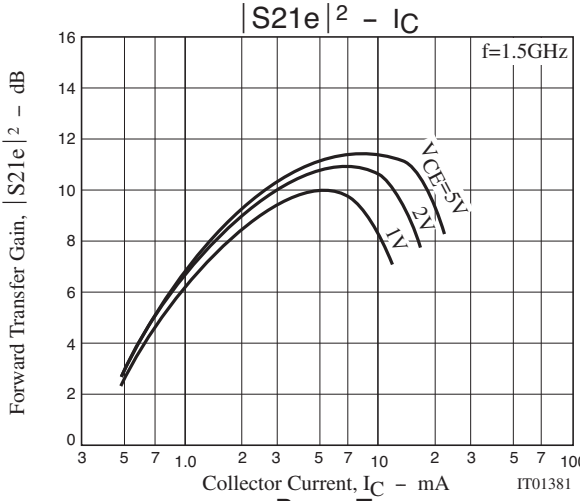
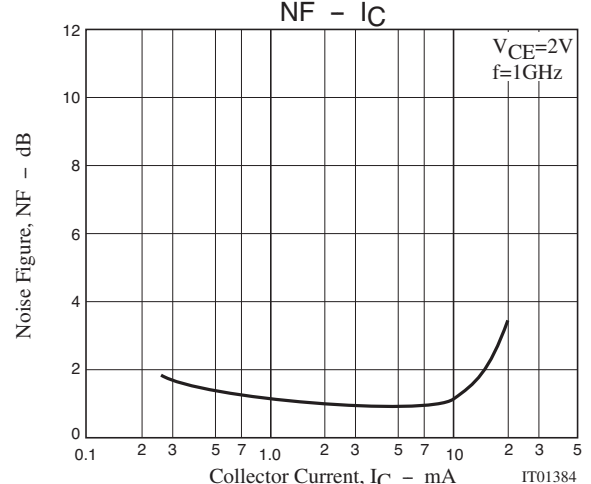
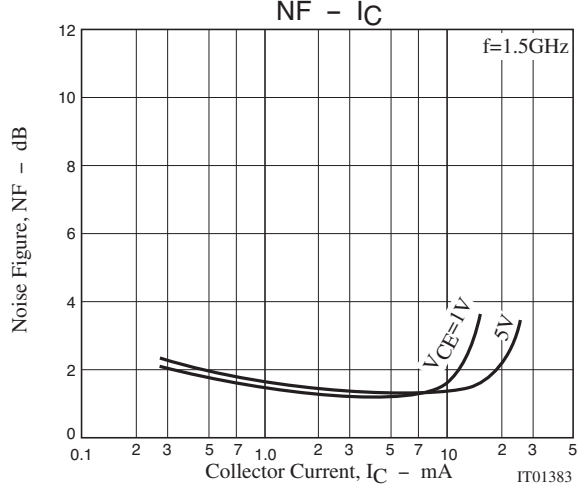
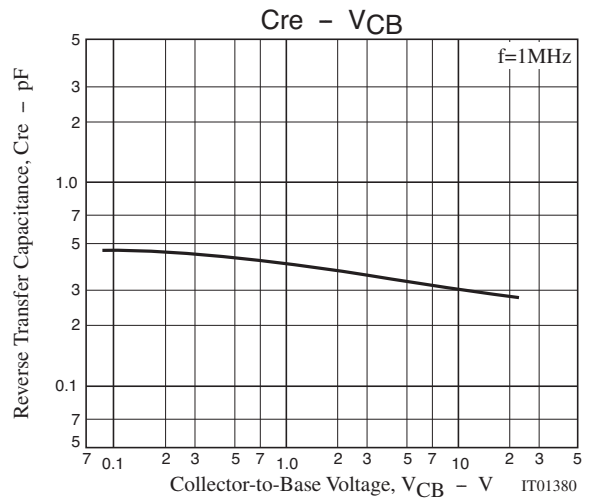
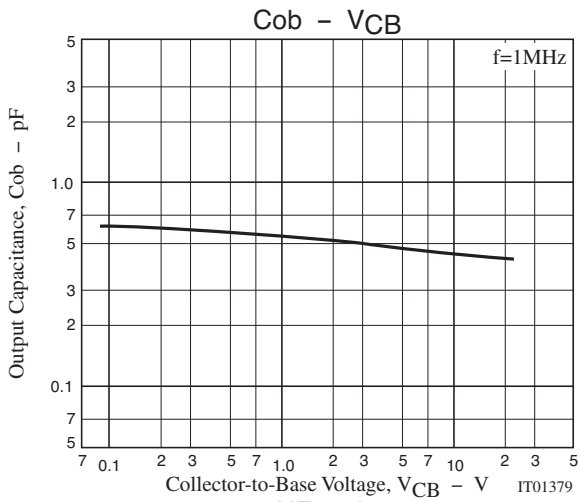

2SC5490A

S Parameters (Common emitter)

$V_{CE}=5V, I_C=5mA, Z_O=50\Omega$

Freq(MHz)	S11	$\angle S11$	S21	$\angle S21$	S12	$\angle S12$	S22	$\angle S22$
200	0.782	-37.1	12.043	148.4	0.038	69.7	0.889	-19.5
400	0.623	-65.4	9.431	126.6	0.057	60.8	0.758	-28.3
600	0.502	-85.6	7.415	112.2	0.072	56.5	0.646	-33.3
800	0.420	-102.4	6.000	101.5	0.083	55.2	0.577	-35.9
1000	0.369	-114.7	5.025	93.6	0.094	55.1	0.538	-37.6
1200	0.339	-127.2	4.323	86.7	0.105	55.6	0.513	-38.7
1400	0.311	-137.2	3.785	80.6	0.115	55.6	0.490	-39.7
1600	0.296	-144.9	3.391	75.3	0.127	56.7	0.480	-41.3
1800	0.285	-156.5	3.018	70.1	0.139	56.4	0.466	-43.5
2000	0.277	-164.2	2.767	65.7	0.150	56.7	0.460	-45.5

$V_{CE}=5V, I_C=10mA, Z_O=50\Omega$

Freq(MHz)	S11	$\angle S11$	S21	$\angle S21$	S12	$\angle S12$	S22	$\angle S22$
200	0.641	-52.7	16.527	137.8	0.031	67.4	0.820	-22.9
400	0.468	-85.4	11.299	115.7	0.048	60.5	0.643	-30.2
600	0.377	-106.6	8.303	103.1	0.060	60.0	0.549	-32.2
800	0.321	-124.1	6.502	94.0	0.072	60.9	0.499	-33.2
1000	0.293	-136.1	5.342	87.4	0.084	61.9	0.477	-33.9
1200	0.280	-146.7	4.546	81.4	0.097	62.7	0.462	-35.0
1400	0.266	-156.6	3.947	76.4	0.108	63.0	0.449	-36.2
1600	0.263	-163.2	3.527	71.4	0.123	63.7	0.444	-37.8
1800	0.263	-173.5	3.121	67.0	0.136	62.8	0.435	-39.9
2000	0.264	-179.8	2.864	62.8	0.150	62.4	0.434	-42.4

$V_{CE}=2V, I_C=3mA, Z_O=50\Omega$

Freq(MHz)	S11	$\angle S11$	S21	$\angle S21$	S12	$\angle S12$	S22	$\angle S22$
200	0.851	-30.4	8.644	154.1	0.042	73.0	0.937	-16.4
400	0.724	-55.7	7.310	133.8	0.073	61.3	0.820	-27.9
600	0.612	-76.1	6.083	118.6	0.093	54.2	0.709	-35.7
800	0.521	-93.0	5.085	106.9	0.107	50.4	0.628	-40.4
1000	0.461	-106.1	4.343	98.1	0.118	48.3	0.572	-43.7
1200	0.423	-118.6	3.806	90.0	0.128	47.5	0.536	-45.8
1400	0.382	-129.4	3.349	83.3	0.137	46.9	0.506	-47.3
1600	0.366	-138.0	3.036	77.5	0.147	47.4	0.485	-49.5
1800	0.341	-148.8	2.685	71.7	0.157	47.2	0.463	-51.9
2000	0.333	-157.7	2.479	66.7	0.167	47.6	0.453	-54.1

$V_{CE}=1V, I_C=1mA, Z_O=50\Omega$

Freq(MHz)	S11	$\angle S11$	S21	$\angle S21$	S12	$\angle S12$	S22	$\angle S22$
200	0.945	-18.7	3.431	162.9	0.053	78.1	0.982	-10.3
400	0.892	-36.9	3.263	147.1	0.099	66.9	0.939	-19.7
600	0.826	-52.9	3.004	133.2	0.136	57.5	0.879	-27.7
800	0.754	-67.9	2.765	120.4	0.164	49.7	0.815	-34.8
1000	0.691	-81.1	2.539	109.9	0.184	43.4	0.758	-40.0
1200	0.639	-94.3	2.366	99.8	0.199	38.4	0.727	-44.3
1400	0.589	-104.9	2.143	91.2	0.207	34.1	0.683	-47.8
1600	0.558	-114.1	1.969	83.6	0.213	31.7	0.653	-51.4
1800	0.522	-124.4	1.797	76.2	0.218	28.7	0.621	-54.9
2000	0.490	-134.9	1.701	69.7	0.219	27.0	0.601	-58.1

Embossed Taping Specification

2SC5490A-TL-H

1. Packing Format

Package Name	Carrier Tape Type	Maximum Number of devices contained (pcs)			Packing format	
		Reel	Inner box	Outer box	Inner BOX (C-1)	Outer BOX (A-7)
SSFP	SSFP	8,000	40,000	240,000	5 reels contained Dimensions:mm (external) 183×72×185	6 inner boxes contained Dimension::mm (external) 440×195×210

Packing method

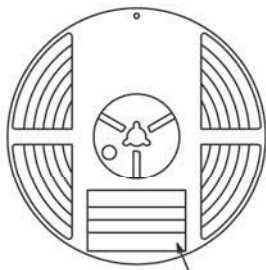

Reel label

Reel label, Inner box label (unit:mm)

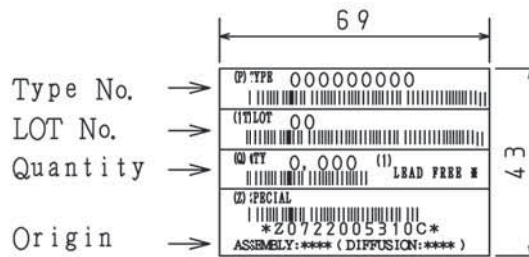

Outer box label

It is a label at the time of factory shipments. The form of a label may change in physical distribution process.

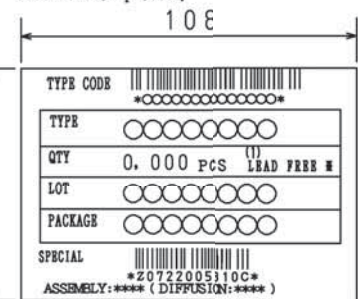

NOTE (1)

The LEAD FREE * description shows that the surface treatment of the terminal is lead free.

Label	JEITA Phase
LEAD FREE 3	JEITA Phase 3A
LEAD FREE 4	JEITA Phase 3

2. Taping configuration

2-1. Carrier tape size (unit:mm)

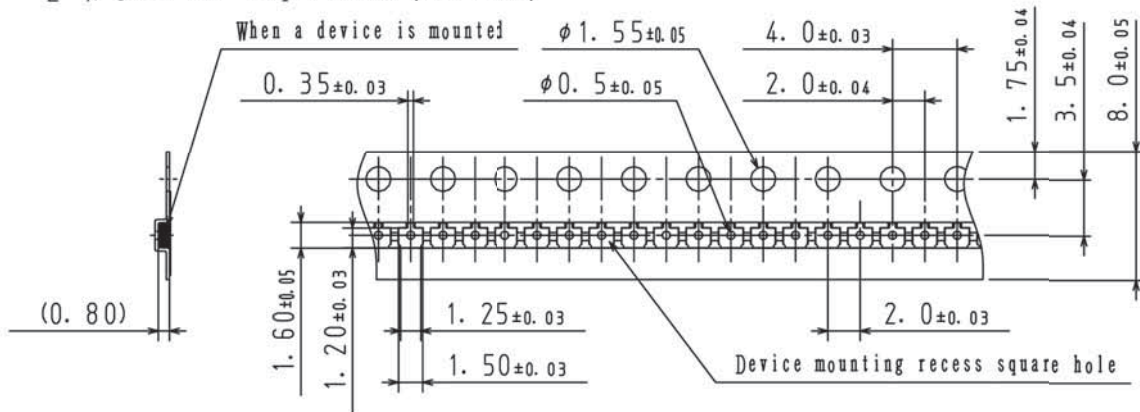

2-2. Device placement direction

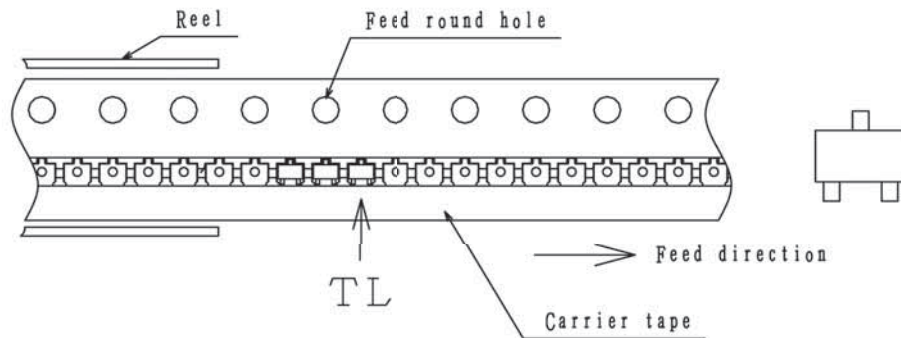

Those with pin 1 index on the feed hole side.....TL

2SC5490A

Outline Drawing

2SC5490A-TL-H

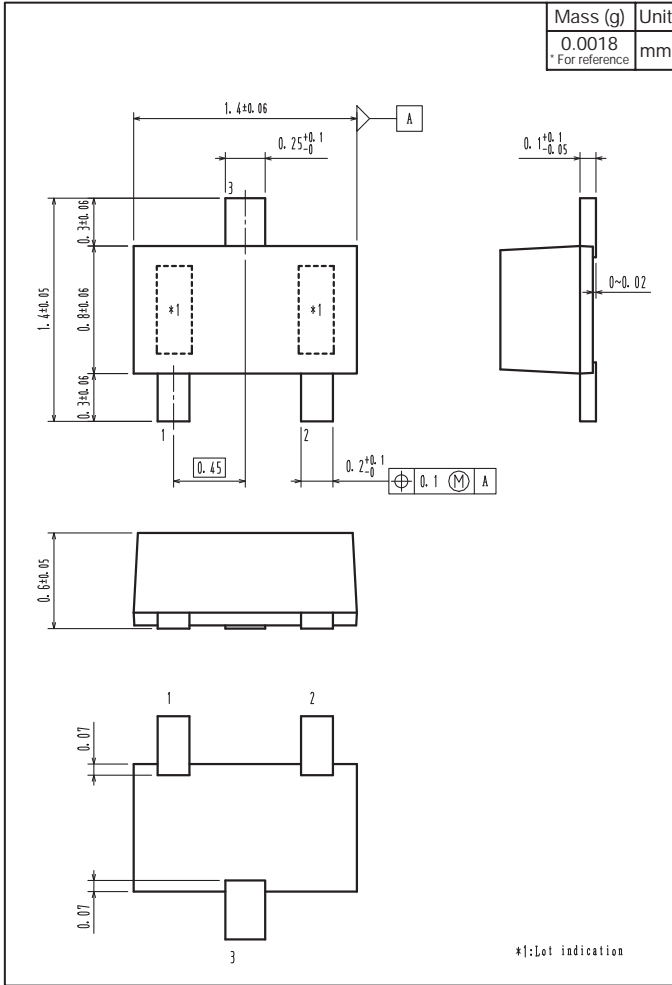

Land Pattern Example



- Any and all SANYO Semiconductor Co.,Ltd. products described or contained herein are, with regard to "standard application", intended for the use as general electronics equipment. The products mentioned herein shall not be intended for use for any "special application" (medical equipment whose purpose is to sustain life, aerospace instrument, nuclear control device, burning appliances, transportation machine, traffic signal system, safety equipment etc.) that shall require extremely high level of reliability and can directly threaten human lives in case of failure or malfunction of the product or may cause harm to human bodies, nor shall they grant any guarantee thereof. If you should intend to use our products for new introduction or other application different from current conditions on the usage of automotive device, communication device, office equipment, industrial equipment etc. , please consult with us about usage condition (temperature, operation time etc.) prior to the intended use. If there is no consultation or inquiry before the intended use, our customer shall be solely responsible for the use.
- Specifications of any and all SANYO Semiconductor Co.,Ltd. products described or contained herein stipulate the performance, characteristics, and functions of the described products in the independent state, and are not guarantees of the performance, characteristics, and functions of the described products as mounted in the customer's products or equipment. To verify symptoms and states that cannot be evaluated in an independent device, the customer should always evaluate and test devices mounted in the customer's products or equipment.
- SANYO Semiconductor Co.,Ltd. assumes no responsibility for equipment failures that result from using products at values that exceed, even momentarily, rated values (such as maximum ratings, operating condition ranges, or other parameters) listed in products specifications of any and all SANYO Semiconductor Co.,Ltd. products described or contained herein.
- Regarding monolithic semiconductors, if you should intend to use this IC continuously under high temperature, high current, high voltage, or drastic temperature change, even if it is used within the range of absolute maximum ratings or operating conditions, there is a possibility of decrease reliability. Please contact us for a confirmation.
- SANYO Semiconductor Co.,Ltd. strives to supply high-quality high-reliability products, however, any and all semiconductor products fail or malfunction with some probability. It is possible that these probabilistic failures or malfunction could give rise to accidents or events that could endanger human lives, trouble that could give rise to smoke or fire, or accidents that could cause damage to other property. When designing equipment, adopt safety measures so that these kinds of accidents or events cannot occur. Such measures include but are not limited to protective circuits and error prevention circuits for safe design, redundant design, and structural design.
- In the event that any or all SANYO Semiconductor Co.,Ltd. products described or contained herein are controlled under any of applicable local export control laws and regulations, such products may require the export license from the authorities concerned in accordance with the above law.
- No part of this publication may be reproduced or transmitted in any form or by any means, electronic or mechanical, including photocopying and recording, or any information storage or retrieval system, or otherwise, without the prior written consent of SANYO Semiconductor Co.,Ltd.
- Any and all information described or contained herein are subject to change without notice due to product/technology improvement, etc. When designing equipment, refer to the "Delivery Specification" for the SANYO Semiconductor Co.,Ltd. product that you intend to use.
- Upon using the technical information or products described herein, neither warranty nor license shall be granted with regard to intellectual property rights or any other rights of SANYO Semiconductor Co.,Ltd. or any third party. SANYO Semiconductor Co.,Ltd. shall not be liable for any claim or suits with regard to a third party's intellectual property rights which has resulted from the use of the technical information and products mentioned above.

This catalog provides information as of July, 2012. Specifications and information herein are subject to change without notice.



Стандарт Электрон Связь

Мы молодая и активно развивающаяся компания в области поставок электронных компонентов. Мы поставляем электронные компоненты отечественного и импортного производства напрямую от производителей и с крупнейших складов мира.

Благодаря сотрудничеству с мировыми поставщиками мы осуществляем комплексные и плановые поставки широчайшего спектра электронных компонентов.

Собственная эффективная логистика и склад в обеспечивает надежную поставку продукции в точно указанные сроки по всей России.

Мы осуществляем техническую поддержку нашим клиентам и предпродажную проверку качества продукции. На все поставляемые продукты мы предоставляем гарантию .

Осуществляем поставки продукции под контролем ВП МО РФ на предприятия военно-промышленного комплекса России , а также работаем в рамках 275 ФЗ с открытием отдельных счетов в уполномоченном банке. Система менеджмента качества компании соответствует требованиям ГОСТ ISO 9001.

Минимальные сроки поставки, гибкие цены, неограниченный ассортимент и индивидуальный подход к клиентам являются основой для выстраивания долгосрочного и эффективного сотрудничества с предприятиями радиоэлектронной промышленности, предприятиями ВПК и научно-исследовательскими институтами России.

С нами вы становитесь еще успешнее!

Наши контакты:

Телефон: +7 812 627 14 35

Электронная почта: sales@st-electron.ru

Адрес: 198099, Санкт-Петербург,
Промышленная ул, дом № 19, литера Н,
помещение 100-Н Офис 331