

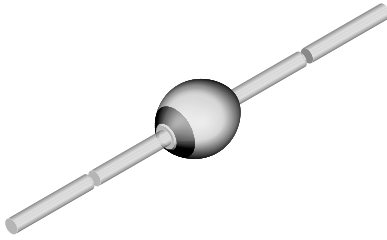

Ultra-Fast Avalanche Sinterglass Diode



949539

FEATURES

- Glass passivated
- Hermetically sealed axial leaded glass envelope
- Low reverse current
- High reverse voltage
- Material categorization:

For definitions of compliance please see www.vishay.com/doc?99912



RoHS
COMPLIANT
HALOGEN
FREE

APPLICATIONS

- Switched mode power supplies
- High-frequency inverter circuits

MECHANICAL DATA

Case: SOD-57

Terminals: plated axial leads, solderable per MIL-STD-750, method 2026

Polarity: color band denotes cathode end

Mounting position: any

Weight: approx. 369 mg

ORDERING INFORMATION (Example)

DEVICE NAME	ORDERING CODE	TAPED UNITS	MINIMUM ORDER QUANTITY
SF4007	SF4007-TR	5000 per 10" tape and reel	25 000
SF4007	SF4007-TAP	5000 per ammpack	25 000

PARTS TABLE

PART	TYPE DIFFERENTIATION	PACKAGE
SF4001	$V_R = 50\text{ V}; I_{F(AV)} = 1\text{ A}$	SOD-57
SF4002	$V_R = 100\text{ V}; I_{F(AV)} = 1\text{ A}$	SOD-57
SF4003	$V_R = 200\text{ V}; I_{F(AV)} = 1\text{ A}$	SOD-57
SF4004	$V_R = 400\text{ V}; I_{F(AV)} = 1\text{ A}$	SOD-57
SF4005	$V_R = 600\text{ V}; I_{F(AV)} = 1\text{ A}$	SOD-57
SF4006	$V_R = 800\text{ V}; I_{F(AV)} = 1\text{ A}$	SOD-57
SF4007	$V_R = 1000\text{ V}; I_{F(AV)} = 1\text{ A}$	SOD-57

ABSOLUTE MAXIMUM RATINGS ($T_{amb} = 25\text{ }^\circ\text{C}$, unless otherwise specified)

PARAMETER	TEST CONDITION	PART	SYMBOL	VALUE	UNIT
Reverse voltage = repetitive peak reverse voltage	See electrical characteristics	SF4001	$V_R = V_{RRM}$	50	V
		SF4002	$V_R = V_{RRM}$	100	V
		SF4003	$V_R = V_{RRM}$	200	V
		SF4004	$V_R = V_{RRM}$	400	V
		SF4005	$V_R = V_{RRM}$	600	V
		SF4006	$V_R = V_{RRM}$	800	V
		SF4007	$V_R = V_{RRM}$	1000	V
Peak forward surge current	$t_p = 10\text{ ms}$, half sine wave		I_{FSM}	30	A



ABSOLUTE MAXIMUM RATINGS ($T_{amb} = 25\text{ }^{\circ}\text{C}$, unless otherwise specified)					
PARAMETER	TEST CONDITION	PART	SYMBOL	VALUE	UNIT
Average forward current	Lead length $l = 10\text{ mm}$		I_{FAV}	1	A
Junction and storage temperature range			$T_j = T_{stg}$	- 55 to + 175	$^{\circ}\text{C}$
Non repetitive reverse avalanche energy	$I_{(BR)R} = 0.4\text{ A}$		E_R	10	mJ

MAXIMUM THERMAL RESISTANCE ($T_{amb} = 25\text{ }^{\circ}\text{C}$, unless otherwise specified)				
PARAMETER	TEST CONDITION	SYMBOL	VALUE	UNIT
Junction ambient	Lead length $l = 10\text{ mm}$, $T_L = \text{constant}$	R_{thJA}	45	K/W
	On PC board with spacing 25 mm	R_{thJA}	100	K/W

ELECTRICAL CHARACTERISTICS ($T_{amb} = 25\text{ }^{\circ}\text{C}$, unless otherwise specified)							
PARAMETER	TEST CONDITION	PART	SYMBOL	MIN.	TYP.	MAX.	UNIT
Forward voltage	$I_F = 1\text{ A}$	SF4001	V_F	-	-	1	V
		SF4002	V_F	-	-	1	V
		SF4003	V_F	-	-	1	V
		SF4004	V_F	-	-	1	V
		SF4005	V_F	-	-	1.7	V
		SF4006	V_F	-	-	1.7	V
		SF4007	V_F	-	-	1.7	V
Reverse current	$V_R = V_{RRM}$		I_R	-	-	5	μA
	$V_R = V_{RRM}$, $T_j = 125\text{ }^{\circ}\text{C}$		I_R	-	-	50	μA
Reverse breakdown voltage	$I_R = 100\text{ }\mu\text{A}$	SF4001	$V_{(BR)R}$	50	-	-	V
		SF4002	$V_{(BR)R}$	100	-	-	V
		SF4003	$V_{(BR)R}$	200	-	-	V
		SF4004	$V_{(BR)R}$	400	-	-	V
		SF4005	$V_{(BR)R}$	600	-	-	V
		SF4006	$V_{(BR)R}$	800	-	-	V
		SF4007	$V_{(BR)R}$	1000	-	-	V
Reverse recovery time	$I_F = 0.5\text{ A}$, $I_R = 1\text{ A}$, $i_R = 0.25\text{ A}$	SF4001	t_{rr}	-	-	50	ns
		SF4002	t_{rr}	-	-	50	ns
		SF4003	t_{rr}	-	-	50	ns
		SF4004	t_{rr}	-	-	50	ns
		SF4005	t_{rr}	-	-	75	ns
		SF4006	t_{rr}	-	-	75	ns
		SF4007	t_{rr}	-	-	75	ns



TYPICAL CHARACTERISTICS ($T_{amb} = 25\text{ }^{\circ}\text{C}$, unless otherwise specified)

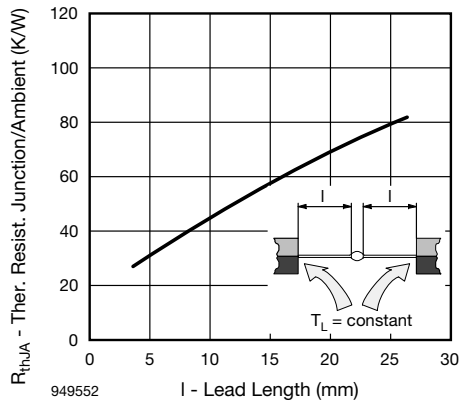

Fig. 1 - Max. Thermal Resistance vs. Lead Length

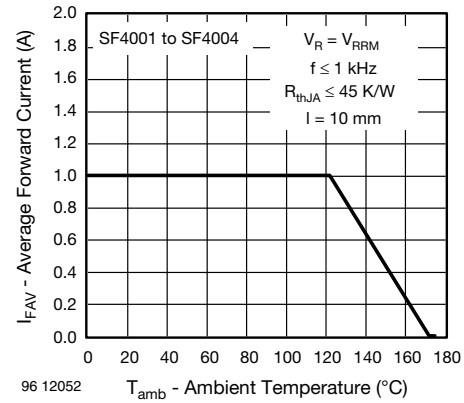

Fig. 4 - Max. Average Forward Current vs. Ambient Temperature

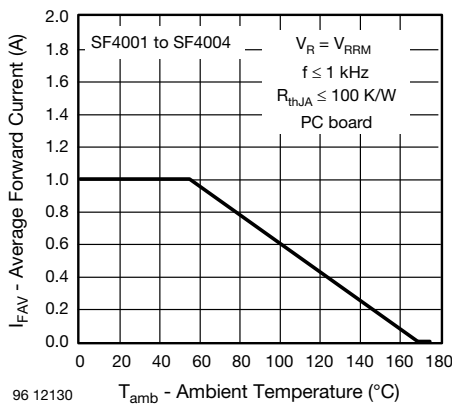

Fig. 2 - Max. Average Forward Current vs. Ambient Temperature

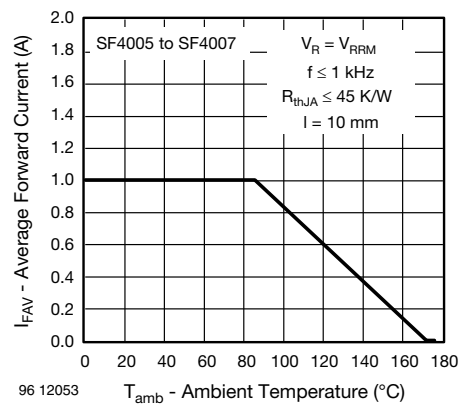

Fig. 5 - Max. Average Forward Current vs. Ambient Temperature

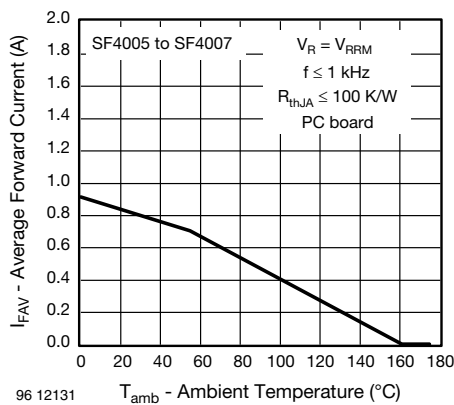

Fig. 3 - Max. Average Forward Current vs. Ambient Temperature

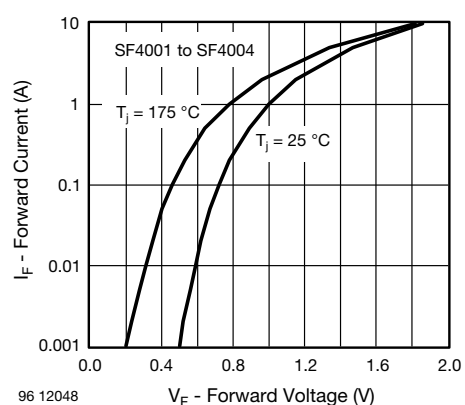

Fig. 6 - Max. Forward Current vs. Forward Voltage

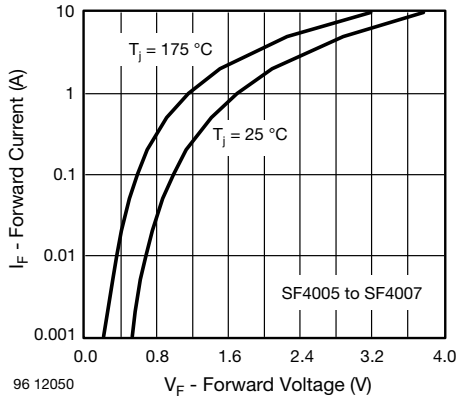

Fig. 7 - Max. Forward Current vs. Forward Voltage

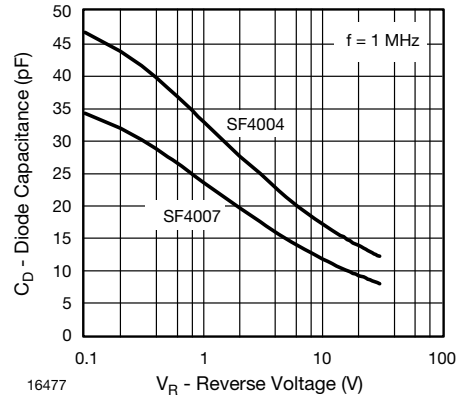

Fig. 10 - Diode Capacitance vs. Reverse Voltage

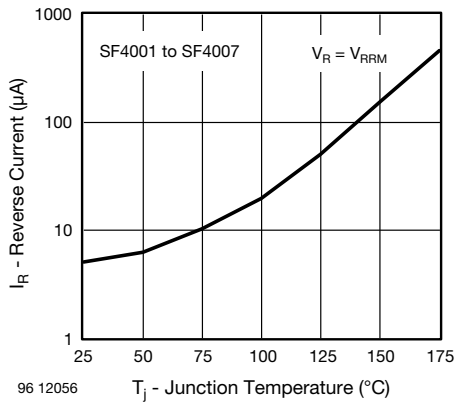

Fig. 8 - Max. Reverse Current vs. Junction Temperature

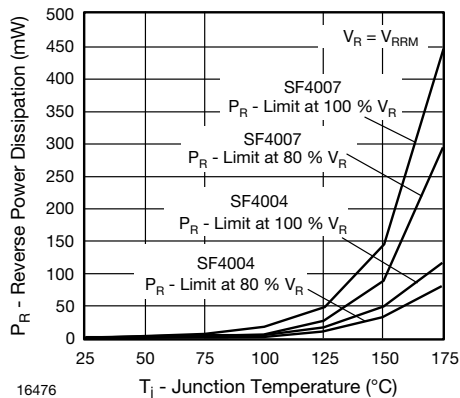
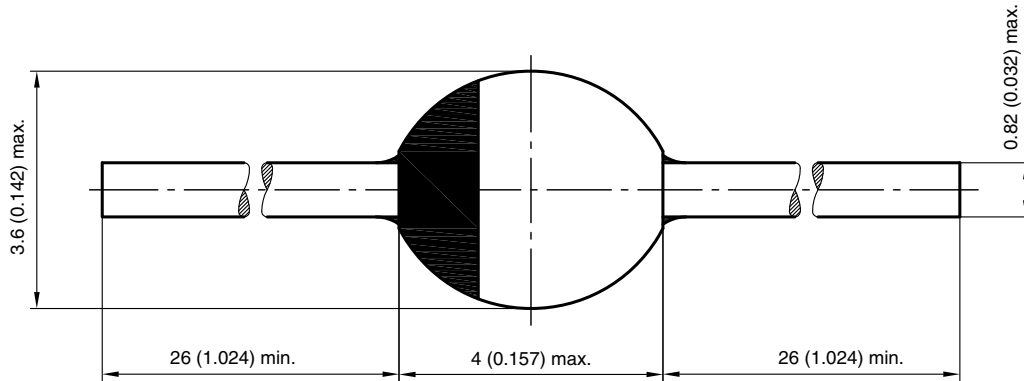

Fig. 9 - Max. Reverse Power Dissipation vs. Junction Temperature



PACKAGE DIMENSIONS in millimeters (inches): **SOD-57**



20543
Rev. 3 - Date: 09.February 2005
Document no.:6.563-5006.3-4



Disclaimer

ALL PRODUCT, PRODUCT SPECIFICATIONS AND DATA ARE SUBJECT TO CHANGE WITHOUT NOTICE TO IMPROVE RELIABILITY, FUNCTION OR DESIGN OR OTHERWISE.

Vishay Intertechnology, Inc., its affiliates, agents, and employees, and all persons acting on its or their behalf (collectively, "Vishay"), disclaim any and all liability for any errors, inaccuracies or incompleteness contained in any datasheet or in any other disclosure relating to any product.

Vishay makes no warranty, representation or guarantee regarding the suitability of the products for any particular purpose or the continuing production of any product. To the maximum extent permitted by applicable law, Vishay disclaims (i) any and all liability arising out of the application or use of any product, (ii) any and all liability, including without limitation special, consequential or incidental damages, and (iii) any and all implied warranties, including warranties of fitness for particular purpose, non-infringement and merchantability.

Statements regarding the suitability of products for certain types of applications are based on Vishay's knowledge of typical requirements that are often placed on Vishay products in generic applications. Such statements are not binding statements about the suitability of products for a particular application. It is the customer's responsibility to validate that a particular product with the properties described in the product specification is suitable for use in a particular application. Parameters provided in datasheets and/or specifications may vary in different applications and performance may vary over time. All operating parameters, including typical parameters, must be validated for each customer application by the customer's technical experts. Product specifications do not expand or otherwise modify Vishay's terms and conditions of purchase, including but not limited to the warranty expressed therein.

Except as expressly indicated in writing, Vishay products are not designed for use in medical, life-saving, or life-sustaining applications or for any other application in which the failure of the Vishay product could result in personal injury or death. Customers using or selling Vishay products not expressly indicated for use in such applications do so at their own risk. Please contact authorized Vishay personnel to obtain written terms and conditions regarding products designed for such applications.

No license, express or implied, by estoppel or otherwise, to any intellectual property rights is granted by this document or by any conduct of Vishay. Product names and markings noted herein may be trademarks of their respective owners.

Material Category Policy

Vishay Intertechnology, Inc. hereby certifies that all its products that are identified as RoHS-Compliant fulfill the definitions and restrictions defined under Directive 2011/65/EU of The European Parliament and of the Council of June 8, 2011 on the restriction of the use of certain hazardous substances in electrical and electronic equipment (EEE) - recast, unless otherwise specified as non-compliant.

Please note that some Vishay documentation may still make reference to RoHS Directive 2002/95/EC. We confirm that all the products identified as being compliant to Directive 2002/95/EC conform to Directive 2011/65/EU.

Vishay Intertechnology, Inc. hereby certifies that all its products that are identified as Halogen-Free follow Halogen-Free requirements as per JEDEC JS709A standards. Please note that some Vishay documentation may still make reference to the IEC 61249-2-21 definition. We confirm that all the products identified as being compliant to IEC 61249-2-21 conform to JEDEC JS709A standards.



**Стандарт
Электрон
Связь**

Мы молодая и активно развивающаяся компания в области поставок электронных компонентов. Мы поставляем электронные компоненты отечественного и импортного производства напрямую от производителей и с крупнейших складов мира.

Благодаря сотрудничеству с мировыми поставщиками мы осуществляем комплексные и плановые поставки широчайшего спектра электронных компонентов.

Собственная эффективная логистика и склад в обеспечивает надежную поставку продукции в точно указанные сроки по всей России.

Мы осуществляем техническую поддержку нашим клиентам и предпродажную проверку качества продукции. На все поставляемые продукты мы предоставляем гарантию .

Осуществляем поставки продукции под контролем ВП МО РФ на предприятия военно-промышленного комплекса России , а также работаем в рамках 275 ФЗ с открытием отдельных счетов в уполномоченном банке. Система менеджмента качества компании соответствует требованиям ГОСТ ISO 9001.

Минимальные сроки поставки, гибкие цены, неограниченный ассортимент и индивидуальный подход к клиентам являются основой для выстраивания долгосрочного и эффективного сотрудничества с предприятиями радиоэлектронной промышленности, предприятиями ВПК и научно-исследовательскими институтами России.

С нами вы становитесь еще успешнее!

Наши контакты:

Телефон: +7 812 627 14 35

Электронная почта: sales@st-electron.ru

Адрес: 198099, Санкт-Петербург,
Промышленная ул, дом № 19, литера Н,
помещение 100-Н Офис 331