

## 80 A high temperature Thyristor (SCR)

Datasheet - production data

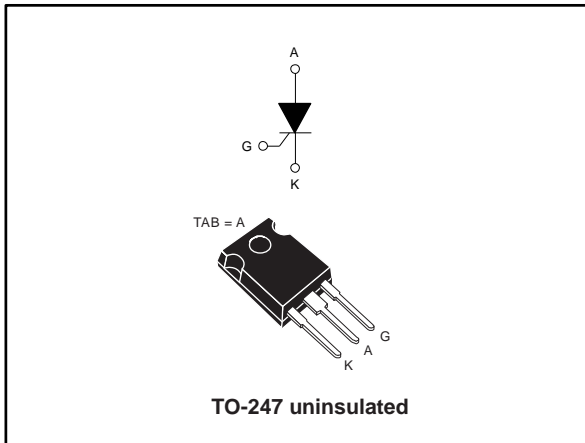

### Features

- High junction temperature:  $T_j = 150\text{ °C}$
- Blocking voltage:  $V_{DRM} = V_{RRM} = 800\text{ V}$
- Nominal current:  $I_{T(RMS)} = 80\text{ A}$
- Gate triggering current:  $I_{GT\ max.} = 50\text{ mA}$
- High noise immunity:  $dV/dt > 1\text{ kV}/\mu\text{s}$
- Through hole package TO-247
- Ecopack<sup>®</sup>2 (includes halogen free & RoHS compliance)
- Increase of thermal margin due to extended  $T_j$  up to  $150\text{ °C}$
- Low  $I_D$  and  $I_R$  in blocking state

### Applications

- Solid state switch
- Battery charging system
- Variable speed motor drive
- Industrial welding systems
- AC-DC rectifier controlled bridge
- Soft starter systems

### Description

Available in high power package (TO-247), the device is suitable in applications where power switching ( $I_{T(RMS)} = 80\text{ A}$  at  $T_C = 126\text{ °C}$ ) and power dissipation ( $V_{TM} = 1.55\text{ V}$  at  $160\text{ A}$ ) are critical, such as motorbike voltage regulator, bypass AC switch, controlled rectifier bridge, solid state relay, battery charger, welding equipment and motor driver applications. The TM8050H-8W is available in through hole TO-247 package.

**Table 1: Device summary**

Symbol	Value
$I_{T(RMS)}$	80 A
$V_{DRM}/V_{RRM}$	800 V
$I_{GT}$	50 mA
$T_j$	150 °C

# 1 Characteristics

**Table 2: Absolute ratings (limiting values)**

Symbol	Parameter		Value	Unit	
$I_{T(RMS)}$	RMS on-state current (180 ° conduction angle)		80	A	
$I_{T(AV)}$	Average on-state current (180 ° conduction angle)				
$I_{TSM}$	Non repetitive surge peak on-state current	$t_p = 8.3 \text{ ms}$	731	A	
		$t_p = 10 \text{ ms}$			
$I^2t$	$I^2t$ value for fusing		2245	A <sup>2</sup> s	
$V_{RRM} / V_{DRM}$	Maximum repetitive symmetric blocking voltage		800	V	
$di/dt$	Critical rate of rise of on-state current $I_G = 2 \times I_{GT}$ , $t_r \leq 100 \text{ ns}$	$f = 50 \text{ Hz}$	$T_j = 25 \text{ °C}$	200	A/ $\mu\text{s}$
$I_{GM}$	Peak gate current	$t_p = 20 \text{ }\mu\text{s}$	$T_j = 150 \text{ °C}$	8	A
$P_{G(AV)}$	Average gate power dissipation		$T_j = 150 \text{ °C}$	1	W
$V_{RGM}$	Maximum peak reverse gate voltage		5	V	
$T_{stg}$	Storage junction temperature range		-40 to +150	°C	
$T_j$	Maximum operating junction temperature		-40 to +150	°C	

**Table 3: Electrical characteristics ( $T_j = 25 \text{ °C}$  unless otherwise specified)**

Symbol	Test Conditions		Value	Unit		
$I_{GT}$	$V_D = 12 \text{ V}$ , $R_L = 33 \text{ }\Omega$	Min.	2.5	mA		
		Max.	50			
$V_{GT}$	$V_D = 12 \text{ V}$ , $R_L = 33 \text{ }\Omega$		Max.	1.5	V	
$V_{GD}$	$V_D = V_{DRM}$ , $R_L = 3.3 \text{ k}\Omega$	$T_j = 150 \text{ °C}$	Min.	0.2	V	
$I_H$	$I_T = 500 \text{ mA}$ , gate open		Max.	100	mA	
$I_L$	$I_G = 1.2 \times I_{GT}$		Max.	125	mA	
$t_{gt}$	$I_T = 80 \text{ A}$ , $V_D = V_{DRM}$ , $I_G = 200 \text{ mA}$ , $di/dt = 0.2 \text{ A}/\mu\text{s}$		Typ.	3	$\mu\text{s}$	
$dV/dt$	$V_D = 67 \text{ \% } V_{DRM}$ , gate open	$T_j = 150 \text{ °C}$	Min.	1000	V/ $\mu\text{s}$	
$t_q$	$I_T = 33 \text{ A}$ , $di_T/dt = 10 \text{ A}/\mu\text{s}$ , $V_R = 75 \text{ V}$ , $V_D = 400 \text{ V}$ , $dV_D/dt = 20 \text{ V}/\mu\text{s}$ , $t_P = 100 \text{ }\mu\text{s}$	$T_j = 150 \text{ °C}$	Max.	150	$\mu\text{s}$	
$V_{TM}$	$I_{TM} = 160 \text{ A}$ , $t_P = 380 \text{ }\mu\text{s}$		$T_j = 25 \text{ °C}$	Max.	1.55	V
$V_{TO}$	Threshold voltage		$T_j = 150 \text{ °C}$	Max.	0.85	V
$R_D$	Dynamic resistance		$T_j = 150 \text{ °C}$	Max.	5.5	m $\Omega$
$I_{DRM}$	$V_D = V_{DRM} = V_R = V_{RRM} = 800 \text{ V}$	$T_j = 25 \text{ °C}$	Max.	20	$\mu\text{A}$	
$I_{RRM}$		$T_j = 150 \text{ °C}$	Max.	2.5	mA	

Table 4: Thermal parameters

Symbol	Parameter	Value	Unit
$R_{th(j-c)}$	Junction to case (DC,max.)	0.30	°C/W
$R_{th(j-a)}$	Junction to ambient (DC, typ., $S_{cu} = 2.1 \text{ cm}^2$ )	50	

# 1.1 Characteristics (curves)

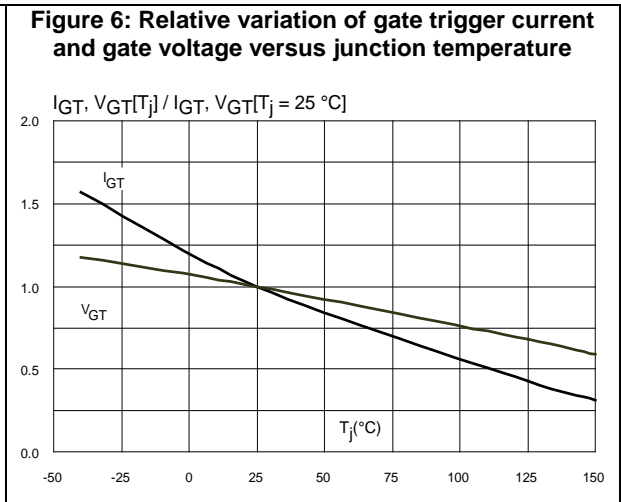
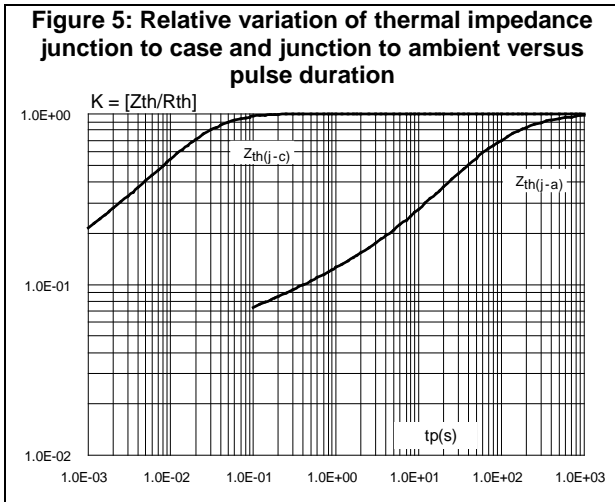
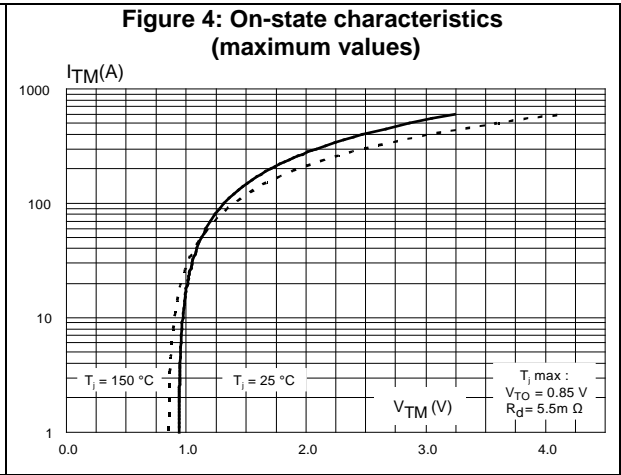
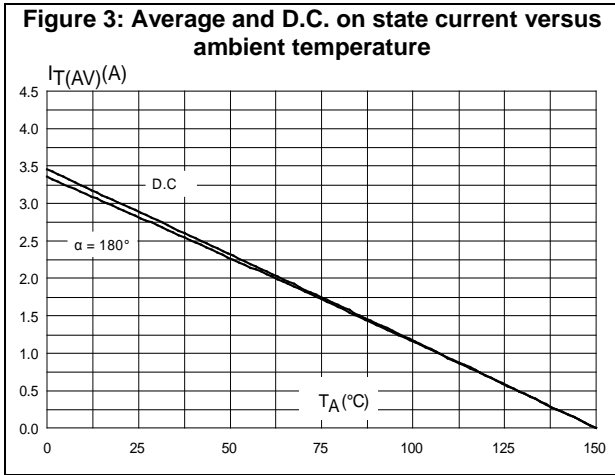
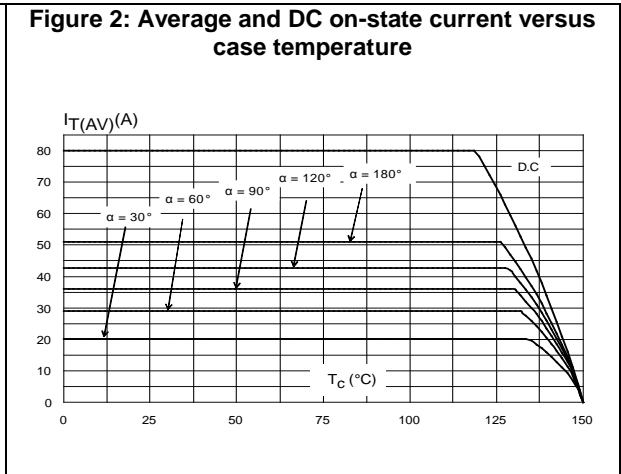
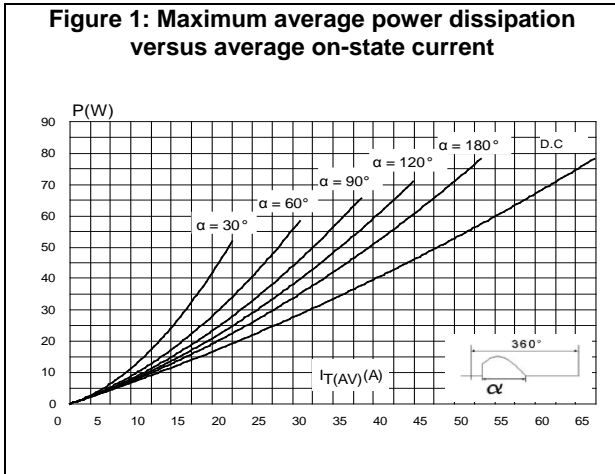

**Figure 7: Relative variation of holding current and latching current versus junction temperature (typical values)**

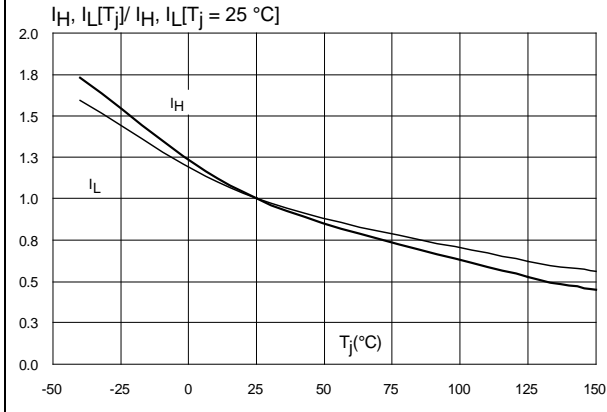

**Figure 8: Surge peak on state current versus number of cycles**

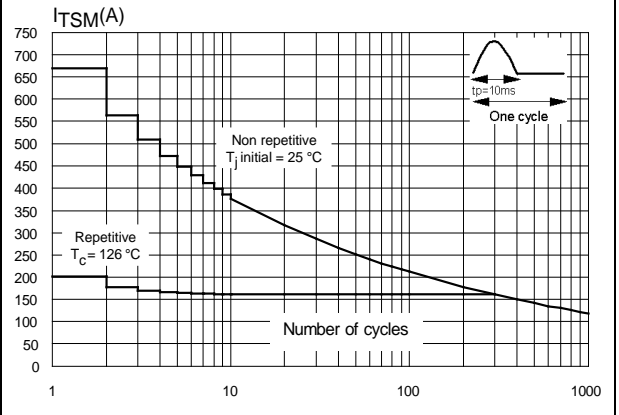

**Figure 9: Non repetitive surge peak on state current for a half cycle sine pulse versus pulse width  $t_p < 10\text{ms}$**

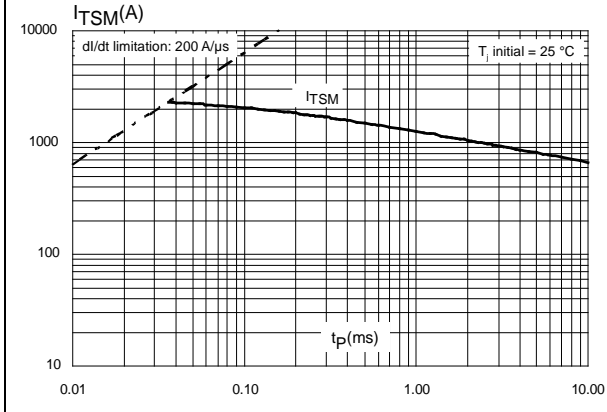

**Figure 10: Relative variation of leakage current versus junction temperature for different values of blocking voltage**

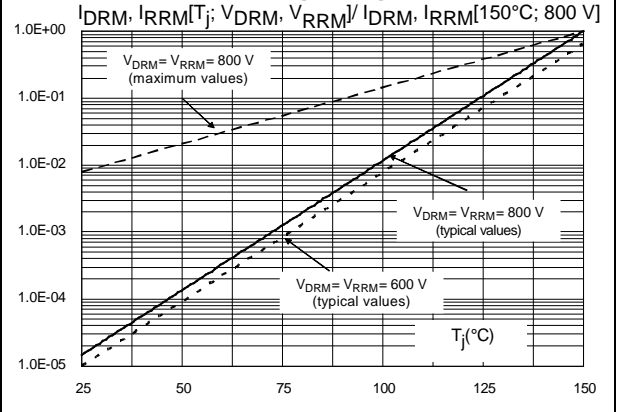

**Figure 11: Relative variation of static dV/dt immunity versus junction temperature (typical values)**

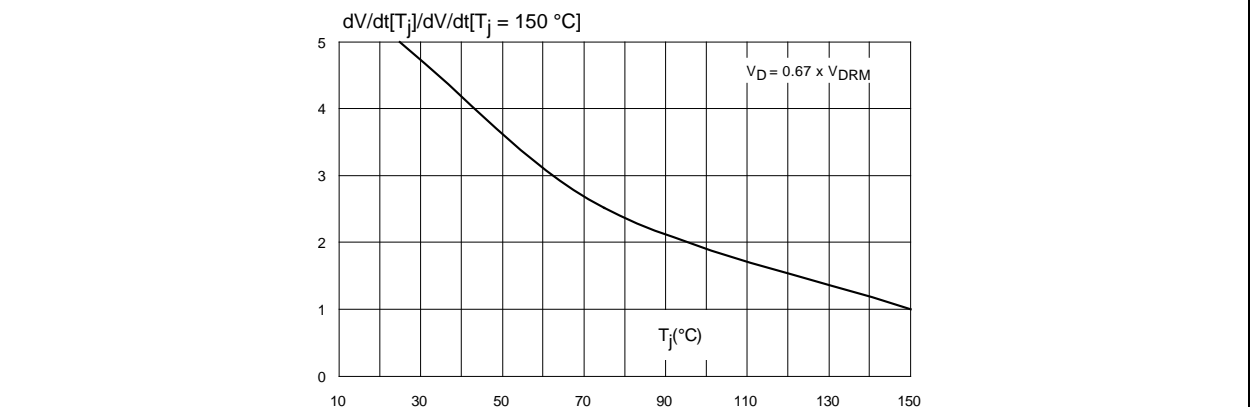

## 2 Package information

In order to meet environmental requirements, ST offers these devices in different grades of ECOPACK® packages, depending on their level of environmental compliance. ECOPACK® specifications, grade definitions and product status are available at: [www.st.com](http://www.st.com). ECOPACK® is an ST trademark.

- Epoxy meets UL94, V0
- Lead-free package lead finishing; halogen-free moulding resin

### 2.1 TO-247 package information

Figure 12: TO-247 package outline

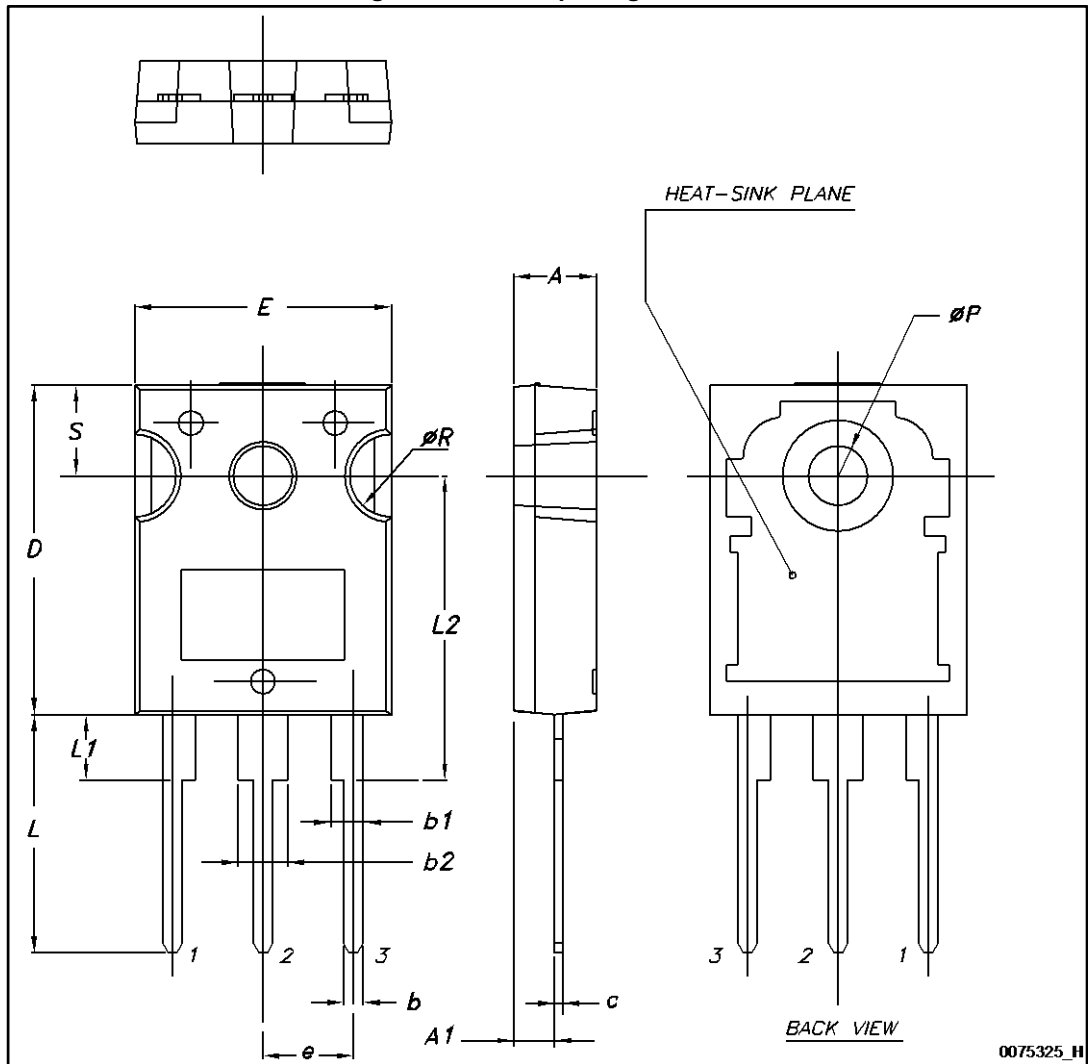

Table 5: TO-247 package mechanical data

Dim.	Dimensions					
	Millimeters			Inches <sup>(1)</sup>		
	Min.	Typ.	Max.	Min.	Typ.	Max.
A	4.85		5.15	0.1909		0.2028
A1	2.20		2.60	0.0866		0.1024
b	1.0		1.40	0.0394		0.0551
b1	2.0		2.40	0.0787		0.0945
b2	3.0		3.40	0.1181		0.1339
c	0.40		0.80	0.0157		0.0315
D <sup>(2)</sup>	19.85		20.15	0.7815		0.7933
E	15.45		15.75	0.6083		0.6201
e	5.30	5.45	5.60	0.2087	0.2146	0.2205
L	14.20		14.80	0.5591		0.5827
L1	3.70		4.30	0.1457		0.1693
L2		18.50			0.7283	
ØP <sup>(3)</sup>	3.55		3.65	0.1398		0.1437
ØR	4.50		5.50	0.1772		0.2165
S	5.30	5.50	5.70	0.2087	0.2165	0.2244

**Notes:**

<sup>(1)</sup>Inch dimensions given only for reference

<sup>(2)</sup>Dimension D plus gate protrusion does not exceed 20.5 mm

<sup>(3)</sup>Resin thickness around the mounting hole is not less than 0.9 mm

### 3 Ordering information

Figure 13: Ordering information scheme

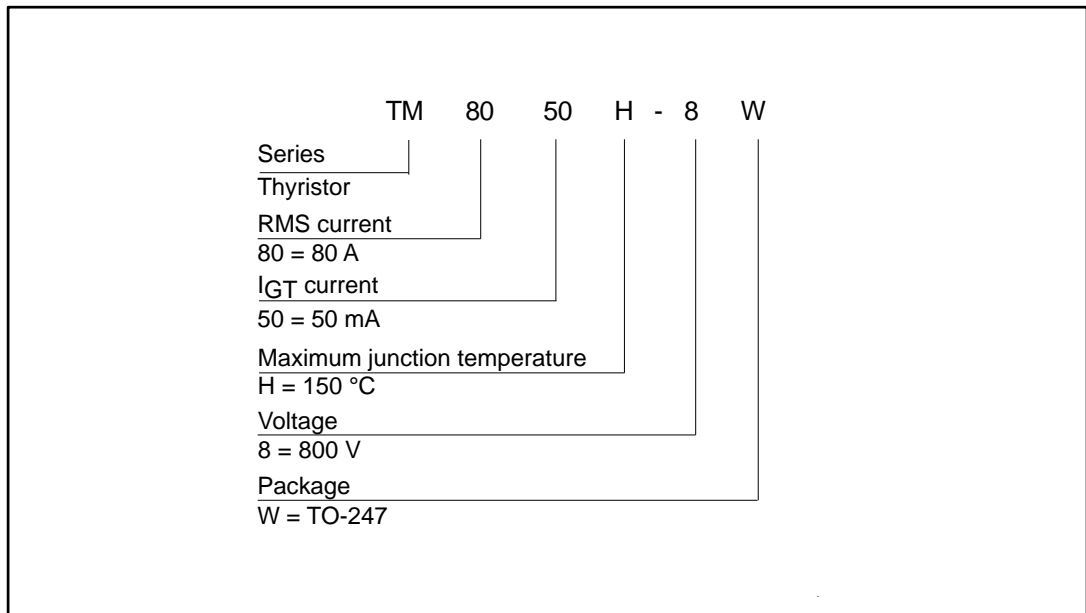

Table 6: Ordering information

Order code	Marking	Package	Weight	Base qty.	Delivery mode
TM8050H-8W	TM8050H8	TO-247	4.43 g	30	Tube

### 4 Revision history

Table 7: Document revision history

Date	Revision	Changes
03-May-2016	1	Initial release.



**IMPORTANT NOTICE – PLEASE READ CAREFULLY**

STMicroelectronics NV and its subsidiaries ("ST") reserve the right to make changes, corrections, enhancements, modifications, and improvements to ST products and/or to this document at any time without notice. Purchasers should obtain the latest relevant information on ST products before placing orders. ST products are sold pursuant to ST's terms and conditions of sale in place at the time of order acknowledgement.

Purchasers are solely responsible for the choice, selection, and use of ST products and ST assumes no liability for application assistance or the design of Purchasers' products.

No license, express or implied, to any intellectual property right is granted by ST herein.

Resale of ST products with provisions different from the information set forth herein shall void any warranty granted by ST for such product.

ST and the ST logo are trademarks of ST. All other product or service names are the property of their respective owners.

Information in this document supersedes and replaces information previously supplied in any prior versions of this document.

© 2016 STMicroelectronics – All rights reserved



## Стандарт Электрон Связь

Мы молодая и активно развивающаяся компания в области поставок электронных компонентов. Мы поставляем электронные компоненты отечественного и импортного производства напрямую от производителей и с крупнейших складов мира.

Благодаря сотрудничеству с мировыми поставщиками мы осуществляем комплексные и плановые поставки широчайшего спектра электронных компонентов.

Собственная эффективная логистика и склад в обеспечивает надежную поставку продукции в точно указанные сроки по всей России.

Мы осуществляем техническую поддержку нашим клиентам и предпродажную проверку качества продукции. На все поставляемые продукты мы предоставляем гарантию .

Осуществляем поставки продукции под контролем ВП МО РФ на предприятия военно-промышленного комплекса России , а также работаем в рамках 275 ФЗ с открытием отдельных счетов в уполномоченном банке. Система менеджмента качества компании соответствует требованиям ГОСТ ISO 9001.

Минимальные сроки поставки, гибкие цены, неограниченный ассортимент и индивидуальный подход к клиентам являются основой для выстраивания долгосрочного и эффективного сотрудничества с предприятиями радиоэлектронной промышленности, предприятиями ВПК и научно-исследовательскими институтами России.

С нами вы становитесь еще успешнее!

### Наши контакты:

**Телефон:** +7 812 627 14 35

**Электронная почта:** [sales@st-electron.ru](mailto:sales@st-electron.ru)

**Адрес:** 198099, Санкт-Петербург,  
Промышленная ул, дом № 19, литера Н,  
помещение 100-Н Офис 331