

RoHS SIDACtor Balanced Series - Modified TO-220

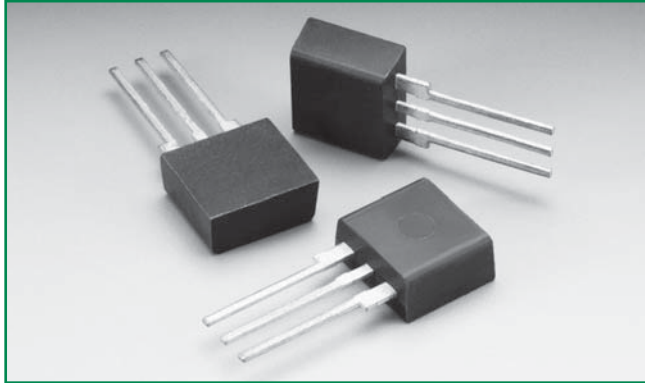

Description

The SIDACtor® Balanced Series are designed to protect baseband equipment from damaging overvoltage transients. The patented "Y" configuration also ensures balanced overvoltage protection.

The series provides a single port through-hole solution that enables voice through DS-1 equipment to comply with various global regulatory standards.

Features and Benefits

- Low voltage overshoot
- Low on-state voltage
- Does not degrade with use
- Fails short circuit when surged in excess of ratings
- Low Capacitance
- Balanced overvoltage protection
- Single port protection
- Custom lead forms available

Agency Approvals

| Agency | Agency File Number |
|--------|--------------------|
| | E133083 |

Pinout Designation

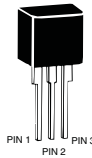

Schematic Symbol



Applicable Global Standards

- TIA-968-A
- TIA-968-B
- ITU K.20/21 Enhanced Level*
- ITU K.20/21 Basic Level
- GR 1089 Inter-building*
- GR 1089 Intra-building
- IEC 61000-4-5
- YD/T 1082
- YD/T 993
- YD/T 950

*A/B-rated parts require series resistance

Electrical Characteristics

| Part Number | Marking | V_{DRM} | V_S | V_{DRM} | V_S | I_H | I_S | I_T | $V_T@I_T=$ | Capacitance |
|-------------|---------|--------------------|----------------|--------------------|----------------|--------|--------|-------|------------|------------------------------|
| | | @ $I_{DRM}=5\mu A$ | @ $100V/\mu s$ | @ $I_{DRM}=5\mu A$ | @ $100V/\mu s$ | | | | 2.2 Amps | |
| | | V min | V max | V min | V max | | | | V max | |
| | | Pins 1-2, 3-2 | | Pins 1-3 | | mA min | mA max | A max | | |
| P1553AALxx | P1553AA | 130 | 180 | 130 | 180 | 150 | 800 | 2.2 | 8 | See Capacitance Values table |
| P1803AALxx | P1803AA | 150 | 210 | 150 | 210 | 150 | 800 | 2.2 | 8 | |
| P2103AALxx | P2103AA | 170 | 250 | 170 | 250 | 150 | 800 | 2.2 | 8 | |
| P2353AALxx | P2353AA | 200 | 270 | 200 | 270 | 150 | 800 | 2.2 | 8 | |
| P2703AALxx | P2703AA | 230 | 300 | 230 | 300 | 150 | 800 | 2.2 | 8 | |
| P3203AALxx | P3203AA | 270 | 350 | 270 | 350 | 150 | 800 | 2.2 | 8 | |
| P3403AALxx | P3403AA | 300 | 400 | 300 | 400 | 150 | 800 | 2.2 | 8 | |
| P5103AALxx | P5103AA | 420 | 600 | 420 | 600 | 150 | 800 | 2.2 | 8 | |
| P1553ABLxx | P1553AB | 130 | 180 | 130 | 180 | 150 | 800 | 2.2 | 8 | |
| P1803ABLxx | P1803AB | 150 | 210 | 150 | 210 | 150 | 800 | 2.2 | 8 | |
| P2103ABLxx | P2103AB | 170 | 250 | 170 | 250 | 150 | 800 | 2.2 | 8 | |

Table continues on next page.

| Part Number | Marking | V_{DRM} @ $I_{DRM}=5\mu A$ | V_S @ 100V/ μs | V_{DRM} @ $I_{DRM}=5\mu A$ | V_S @ 100V/ μs | I_H | I_S | I_T | $V_T@I_T=$ 2.2 Amps | Capacitance |
|-------------|---------|---------------------------------|--------------------------|---------------------------------|--------------------------|--------|--------|-------|------------------------|------------------------------------|
| | | V min | V max | V min | V max | mA min | mA max | A max | V max | |
| | | Pins 1-2, 3-2 | | Pins 1-3 | | | | | | |
| P2353ABLxx | P2353AB | 200 | 270 | 200 | 270 | 150 | 800 | 2.2 | 8 | See Capacitance Values table |
| P2703ABLxx | P2703AB | 230 | 300 | 230 | 300 | 150 | 800 | 2.2 | 8 | |
| P3203ABLxx | P3203AB | 270 | 350 | 270 | 350 | 150 | 800 | 2.2 | 8 | |
| P3403ABLxx | P3403AB | 300 | 400 | 300 | 400 | 150 | 800 | 2.2 | 8 | |
| P5103ABLxx | P5103AB | 420 | 600 | 420 | 600 | 150 | 800 | 2.2 | 8 | |
| P1553ACLxx | P1553AC | 130 | 180 | 130 | 180 | 150 | 800 | 2.2 | 8 | |
| P1803ACLxx | P1803AC | 150 | 210 | 150 | 210 | 150 | 800 | 2.2 | 8 | |
| P2103ACLxx | P2103AC | 170 | 250 | 170 | 250 | 150 | 800 | 2.2 | 8 | |
| P2353ACLxx | P2353AC | 200 | 270 | 200 | 270 | 150 | 800 | 2.2 | 8 | |
| P2703ACLxx | P2703AC | 230 | 300 | 230 | 300 | 150 | 800 | 2.2 | 8 | |
| P3203ACLxx | P3203AC | 270 | 350 | 270 | 350 | 150 | 800 | 2.2 | 8 | |
| P3403ACLxx | P3403AC | 300 | 400 | 300 | 400 | 150 | 800 | 2.2 | 8 | |
| P5103ACLxx | P5103AC | 420 | 600 | 420 | 600 | 150 | 800 | 2.2 | 8 | |

Notes:
 - Absolute maximum ratings measured at $T_A = 25^\circ C$.
 - Devices are bi-directional.
 - **XX** Part Number Suffix: '**RP**' (Reel Pack), '**Blank**' (Bulk Pack), or '**60**' (Type 60 lead form, Bulk Pack)

Capacitance Values

| Part Number | pF Pin 1-2 / 3-2 Tip-Ground, Ring-Ground | | pF Pin 1-3 Tip-Ring | |
|-------------|--|-----|---------------------------|-----|
| | MIN | MAX | MIN | MAX |
| | P1553AALxx | 10 | 45 | 10 |
| P1803AALxx | 20 | 40 | 10 | 30 |
| P2103AALxx | 15 | 35 | 10 | 25 |
| P2353AALxx | 15 | 35 | 10 | 25 |
| P2703AALxx | 15 | 35 | 10 | 25 |
| P3203AALxx | 15 | 30 | 10 | 20 |
| P3403AALxx | 15 | 30 | 10 | 20 |
| P5103AALxx | 10 | 60 | 10 | 40 |
| P1553ABLxx | 25 | 95 | 15 | 60 |
| P1803ABLxx | 25 | 85 | 15 | 55 |
| P2103ABLxx | 20 | 85 | 10 | 55 |
| P2353ABLxx | 20 | 75 | 15 | 50 |

| Part Number | pF Pin 1-2 / 3-2 Tip-Ground, Ring-Ground | | pF Pin 1-3 Tip-Ring | |
|-------------|--|-----|---------------------------|-----|
| | MIN | MAX | MIN | MAX |
| | P2703ABLxx | 20 | 75 | 10 |
| P3203ABLxx | 20 | 70 | 10 | 45 |
| P3403ABLxx | 15 | 65 | 10 | 45 |
| P5103ABLxx | 15 | 60 | 10 | 40 |
| P1553ACLxx | 30 | 95 | 20 | 60 |
| P1803ACLxx | 30 | 85 | 15 | 55 |
| P2103ACLxx | 30 | 85 | 15 | 55 |
| P2353ACLxx | 25 | 75 | 15 | 50 |
| P2703ACLxx | 25 | 75 | 15 | 50 |
| P3203ACLxx | 25 | 70 | 15 | 45 |
| P3403ACLxx | 20 | 65 | 15 | 45 |
| P5103ACLxx | 20 | 60 | 10 | 40 |

Note: Off-state capacitance (C_O) is measured at 1 MHz with a 2 V bias.

Surge Ratings

| Series | I_{PP} | | | | | | | | | I_{TSM} 50/60 Hz | di/dt A |
|--------|--|--|--|--|--|--|--|--|---|-----------------------|------------|
| | 0.2x310 ¹ 0.5x700 ² | 2x10 ¹ 2x10 ² | 8x20 ¹ 1.2x50 ² | 10x160 ¹ 10x160 ² | 10x560 ¹ 10x560 ² | 5x320 ¹ 9x720 ² | 10x360 ¹ 10x360 ² | 10x1000 ¹ 10x1000 ² | 5x310 ¹ 10x700 ² | | |
| | A min | A min | A min | A min | A min | A min | A min | A min | A min | | |
| A | 20 | 150 | 150 | 90 | 50 | 75 | 75 | 45 | 75 | 20 | 500 |
| B | 25 | 250 | 250 | 150 | 100 | 100 | 125 | 80 | 100 | 25 | 500 |
| C | 50 | 500 | 400 | 200 | 150 | 200 | 175 | 100 | 200 | 50 | 500 |

Notes:
 1 Current waveform in μs
 2 Voltage waveform in μs
 - Peak pulse current rating (I_{pp}) is repetitive and guaranteed for the life of the product.
 - I_{pp} ratings applicable over temperature range of $-40^\circ C$ to $+85^\circ C$
 - The device must initially be in thermal equilibrium with $-40^\circ C \leq T_J \leq +150^\circ C$

Thermal Considerations

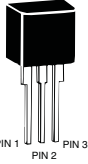
| Package | Symbol | Parameter | Value | Unit |
|--|-----------------|---|-------------|------|
| Modified TO-220  | T_J | Operating Junction Temperature Range | -40 to +150 | °C |
| | T_S | Storage Temperature Range | -65 to +150 | °C |
| | $R_{\theta JA}$ | Thermal Resistance: Junction to Ambient | 50 | °C/W |

V-I Characteristics

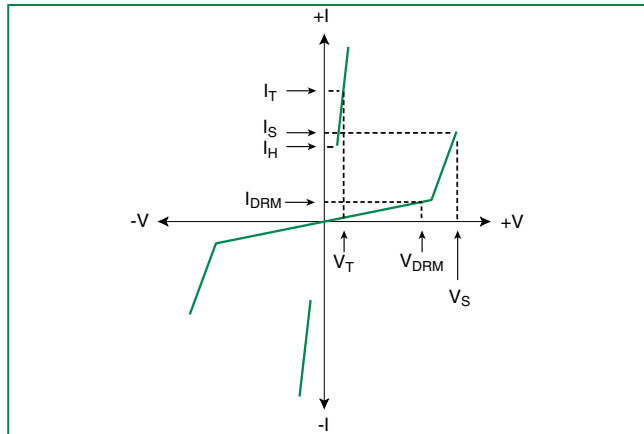

$t_r \times t_d$ Pulse Waveform



Normalized V_S Change vs. Junction Temperature

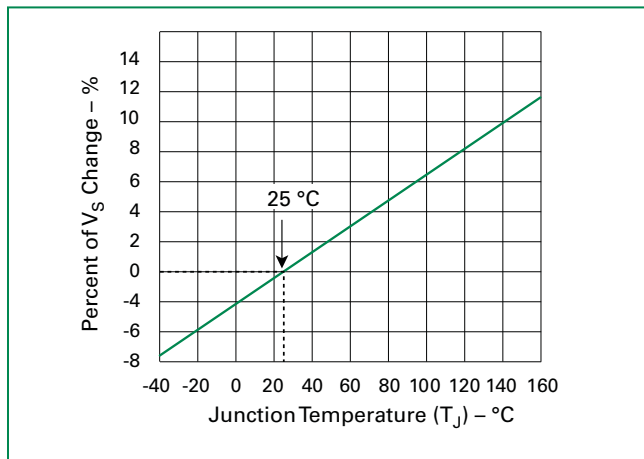

Normalized DC Holding Current vs. Case Temperature



Soldering Parameters

| | | |
|--|-----------------------------------|-------------------------------|
| Reflow Condition | | Pb-Free assembly (see Fig. 1) |
| Pre Heat | -Temperature Min ($T_{s(min)}$) | +150°C |
| | -Temperature Max ($T_{s(max)}$) | +200°C |
| | -Time (Min to Max) (t_s) | 60-180 secs. |
| Average ramp up rate (Liquidus Temp (T_L) to peak) | | 3°C/sec. Max. |
| $T_{s(max)}$ to T_L - Ramp-up Rate | | 3°C/sec. Max. |
| Reflow | -Temperature (T_L) (Liquidus) | +217°C |
| | -Temperature (t_L) | 60-150 secs. |
| Peak Temp (T_p) | | +260(+0/-5)°C |
| Time within 5°C of actual Peak Temp (t_p) | | 30 secs. Max. |
| Ramp-down Rate | | 6°C/sec. Max. |
| Time 25°C to Peak Temp (T_p) | | 8 min. Max. |
| Do not exceed | | +260°C |



Physical Specifications

| | |
|------------------------|---|
| Lead Material | Copper Alloy |
| Terminal Finish | 100% Matte-Tin Plated |
| Body Material | UL recognized epoxy meeting flammability classification 94V-0 |

Environmental Specifications

| | |
|---|--|
| High Temp Voltage Blocking | 80% Rated V_{DRM} ($V_{AC Peak}$) +125°C or +150°C, 504 or 1008 hrs. MIL-STD-750 (Method 1040) JEDEC, JESD22-A-101 |
| Temp Cycling | -65°C to +150°C, 15 min. dwell, 10 up to 100 cycles. MIL-STD-750 (Method 1051) EIA/JEDEC, JESD22-A104 |
| Biased Temp & Humidity | 52 V_{DC} (+85°C) 85%RH, 504 up to 1008 hrs. EIA/JEDEC, JESD22-A-101 |
| High Temp Storage | +150°C 1008 hrs. MIL-STD-750 (Method 1031) JEDEC, JESD22-A-101 |
| Low Temp Storage | -65°C, 1008 hrs. |
| Thermal Shock | 0°C to +100°C, 5 min. dwell, 10 sec. transfer, 10 cycles. MIL-STD-750 (Method 1056) JEDEC, JESD22-A-106 |
| Autoclave (Pressure Cooker Test) | +121°C, 100%RH, 2atm, 24 up to 168 hrs. EIA/JEDEC, JESD22-A-102 |
| Resistance to Solder Heat | +260°C, 30 secs. MIL-STD-750 (Method 2031) |
| Moisture Sensitivity Level | 85%RH, +85°C, 168 hrs., 3 reflow cycles (+260°C Peak). JEDEC-J-STD-020, Level 1 |

Part Numbering

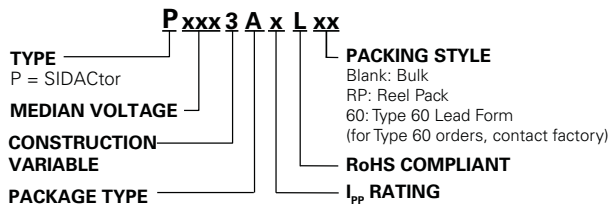

Part Marking

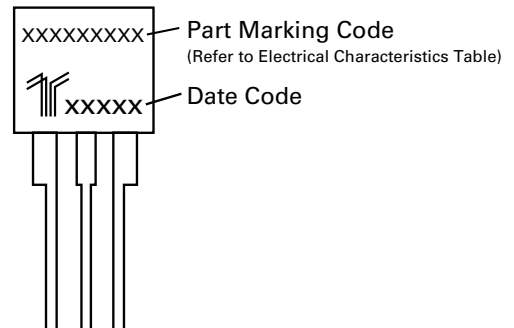

Dimensions - Modified TO-220

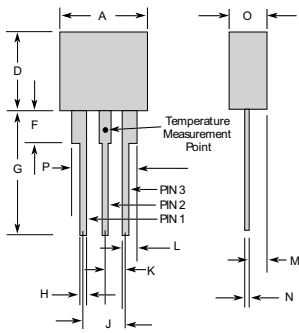

The modified TO-220 package is designed to meet mechanical standards as set forth in JEDEC publication number 95.

| | Inches | | Millimeters | |
|----------|--------|-------|-------------|-------|
| | Min | Max | Min | Max |
| A | 0.400 | 0.410 | 10.16 | 10.42 |
| D | 0.360 | 0.375 | 9.14 | 9.53 |
| F | 0.110 | 0.130 | 2.80 | 3.30 |
| G | 0.540 | 0.575 | 13.71 | 14.61 |
| H | 0.025 | 0.035 | 0.63 | 0.89 |
| J | 0.195 | 0.205 | 4.95 | 5.21 |
| K | 0.095 | 0.105 | 2.41 | 2.67 |
| L | 0.060 | 0.075 | 1.52 | 1.90 |
| M | 0.070 | 0.085 | 1.78 | 2.16 |
| N | 0.018 | 0.024 | 0.46 | 0.61 |
| O | 0.178 | 0.188 | 4.52 | 4.78 |
| P | 0.290 | 0.310 | 7.37 | 7.87 |

Tape and Reel Specification — Modified TO-220

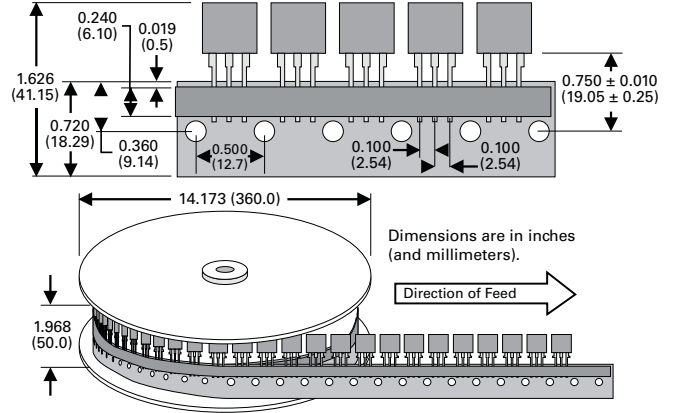

Packing Options

| Package Type | Description | Packaging Quantity | Added Suffix | Industry Standard |
|--------------|---|--------------------|---|-------------------|
| A | Modified TO-220 Tape and Reel Pack | 700 | RP | EIA-468-B |
| | Modified TO-220 Bulk Pack | 500 | N / A (no suffix required) | EIA-468-B |
| | Modified TO-220 Type 60 Lead Form Bulk Pack | 500 | 60 (special order item, contact factory for details) | N/A |



Стандарт Электрон Связь

Мы молодая и активно развивающаяся компания в области поставок электронных компонентов. Мы поставляем электронные компоненты отечественного и импортного производства напрямую от производителей и с крупнейших складов мира.

Благодаря сотрудничеству с мировыми поставщиками мы осуществляем комплексные и плановые поставки широчайшего спектра электронных компонентов.

Собственная эффективная логистика и склад в обеспечивает надежную поставку продукции в точно указанные сроки по всей России.

Мы осуществляем техническую поддержку нашим клиентам и предпродажную проверку качества продукции. На все поставляемые продукты мы предоставляем гарантию .

Осуществляем поставки продукции под контролем ВП МО РФ на предприятия военно-промышленного комплекса России , а также работаем в рамках 275 ФЗ с открытием отдельных счетов в уполномоченном банке. Система менеджмента качества компании соответствует требованиям ГОСТ ISO 9001.

Минимальные сроки поставки, гибкие цены, неограниченный ассортимент и индивидуальный подход к клиентам являются основой для выстраивания долгосрочного и эффективного сотрудничества с предприятиями радиоэлектронной промышленности, предприятиями ВПК и научно-исследовательскими институтами России.

С нами вы становитесь еще успешнее!

Наши контакты:

Телефон: +7 812 627 14 35

Электронная почта: sales@st-electron.ru

Адрес: 198099, Санкт-Петербург,
Промышленная ул, дом № 19, литера Н,
помещение 100-Н Офис 331