

Surface Mount Polymer PTC

PMS Series, 0603 Size

Features:

- Resettable over-current protection
- Small size of 0603
- Fast time-to-trip
- RoHS compliant
- Halogen free

Applications:

- Battery packs
- Portable electronic devices
- Industrial controls
- Multimedia
- Game machines
- Telecom & broadband instruments

Ordering Code:

PMS 0603-035

(1) (2) (3)

- (1) Series code
- (2) Size code
- (3) Current rating code
035: 0.35A

Agency Approval:

Recognized under the components program of UL.
File number: E355716

Product Dimensions:

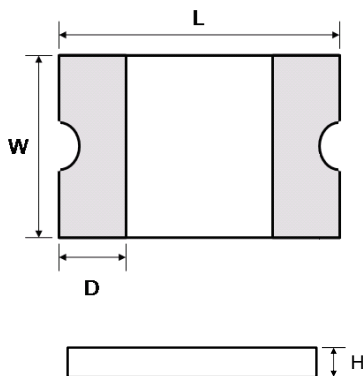

Part Number	L (mm) Max.	W (mm) Max.	H (mm) Max.	D (mm) Min.
PMS0603-005	1.85	1.05	1.00	0.15
PMS0603-010	1.85	1.05	1.00	0.15
PMS0603-020	1.85	1.05	1.00	0.15
PMS0603-025	1.85	1.05	1.00	0.15
PMS0603-035	1.85	1.05	1.00	0.15
PMS0603-050	1.85	1.05	1.10	0.15
PMS0603-075	1.85	1.05	1.10	0.15

Fig. 1 Product scheme and dimensions.

Typical Ratings and Characteristics (@ 25°C):

✧ Operating temperature: -40 to +85°C

Part Number	Current (A)		V _{Max} (Vdc)	I _{Max} (A)	Max. Time to Trip (sec)		Typical Power (Pd, W)	Resistance Min. (Ω)	One Hours Post Reflow Resistance R ₁ Max. (Ω) ¹	UL Certification
	Hold (I _H)	Trip (I _T)			Current (A)	Time (sec)				
PMS0603-005	0.05	0.20	15	40	0.5	1.00	0.50	2.000	10.000	
PMS0603-010	0.10	0.30	15	40	0.5	1.00	0.50	0.900	6.000	
PMS0603-020	0.20	0.50	9	40	1.0	0.60	0.50	0.550	3.500	√
PMS0603-025	0.25	0.55	9	40	8.0	0.08	0.50	0.500	3.000	√
PMS0603-035	0.35	0.75	6	40	8.0	0.10	0.50	0.200	1.400	√
PMS0603-050	0.50	1.00	6	40	8.0	0.10	0.50	0.100	0.800	√
PMS0603-075	0.75	1.40	6	40	8.0	0.10	0.50	0.060	0.450	√

¹ The max resistance of one-hour post reflow is a reference value. The value may change a little according to reflow conditions and soldering state.

Packaging and Marking Information:

Part Number	Part Marking	Tape & Reel Quantity (piece)
PMS0603-005	V	5,000
PMS0603-010	1	
PMS0603-020	2	
PMS0603-025	2	
PMS0603-035	3	
PMS0603-050	5	
PMS0603-075	7	

Thermal De-rating Hold Current (A) at Ambient Temperature (25°C):

Part Number	Ambient temperature								
	-40°C	-20°C	0°C	25°C	40°C	50°C	60°C	70°C	85°C
PMS0603-005	0.072	0.065	0.058	0.05	0.041	0.037	0.033	0.030	0.024
PMS0603-010	0.13	0.12	0.11	0.10	0.08	0.07	0.06	0.05	0.03
PMS0603-020	0.27	0.25	0.23	0.20	0.17	0.14	0.12	0.10	0.07
PMS0603-025	0.32	0.29	0.27	0.25	0.21	0.18	0.16	0.13	0.09
PMS0603-035	0.47	0.41	0.38	0.35	0.29	0.26	0.24	0.20	0.14
PMS0603-050	0.67	0.59	0.54	0.50	0.41	0.37	0.34	0.29	0.20
PMS0603-075	0.98	0.85	0.81	0.75	0.60	0.54	0.44	0.40	0.31

Typical Time to Trip (@ 25°C):

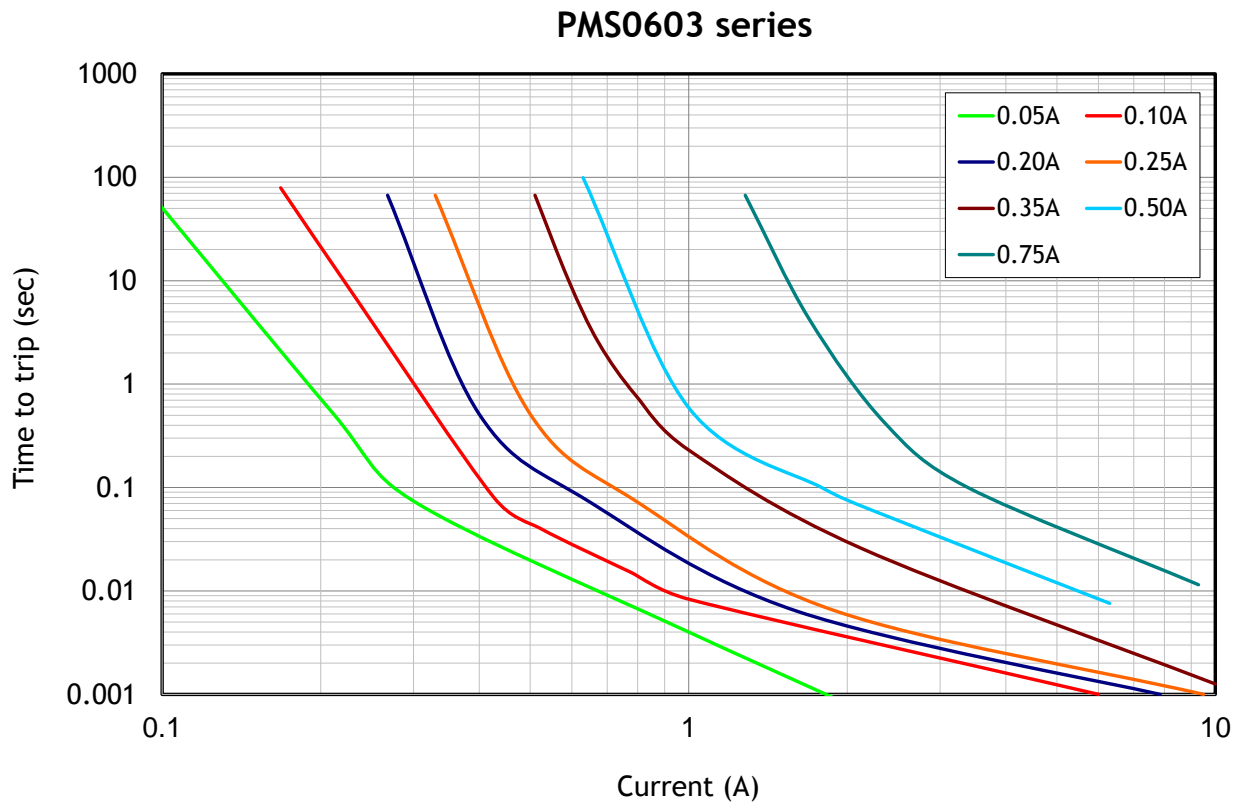

Recommended Foot Print Dimensions:

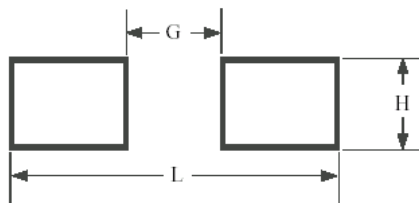

G (mm)	H (mm)	L (mm)
0.8	1.0	2.2

Fig. 2 Solder pads scheme and recommended dimensions.

Recommended Reflow Soldering Profile:

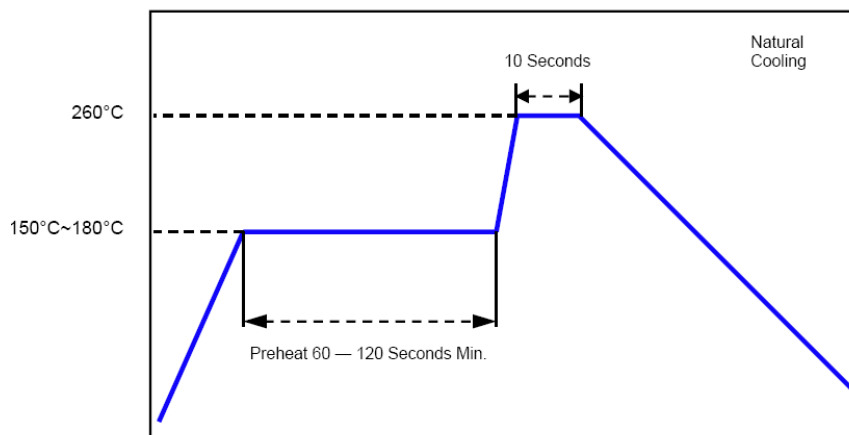

Fig. 3 Recommended reflow soldering profile

1. Recommended reflow methods: IR, hot air oven, nitrogen oven.
2. Recommended maximum paste thickness: 0.25mm (0.010 inch).
3. Devices can be cleaned using standard industry methods and solvents.
4. Soldering temperature and time should not exceed the recommended conditions.

Note: If reflow temperatures exceed the recommended profile, devices may not meet the performance requirements.

Caution: Operation beyond the rated voltage or current may result in rupture electrical arcing or flame.



WARNING:

- Operation beyond the maximum ratings or improper use may result in device damage and possible electrical arcing and flame.
- The devices are intended for protection against occasional over-current or over-temperature fault conditions and should not be used when repeated fault conditions or prolonged trip events are anticipated.
- Contamination of the PPTC material with certain silicon based oils or some aggressive solvents can adversely impact the performance of the devices.
- Device performance can be impacted negatively if devices are handled in a manner inconsistent with recommended electronic, thermal and mechanical procedures for electronic components.
- Operation in circuit with a large inductance can generate a circuit voltage ($L di/dt$) above the rated voltage of the PPTC device.

Surface Mount Polymer PTC

PMS Series, 0805 Size



Features:

- Resettable over-current protection
- Small size of 0805
- Fast time-to-trip
- RoHS compliant
- Halogen free

Applications:

- Battery packs
- Portable electronic devices
- Industrial controls
- Multimedia
- Game machines
- Telecom & broadband instruments

Ordering Code:

PMS 0805-035

(1) (2) (3)

- (1) Series code
 (2) Size code
 (3) Current rating code
 035: 0.35A

Agency Approval:

Recognized under the components program of UL.
 File number: E355716

Product Dimensions:

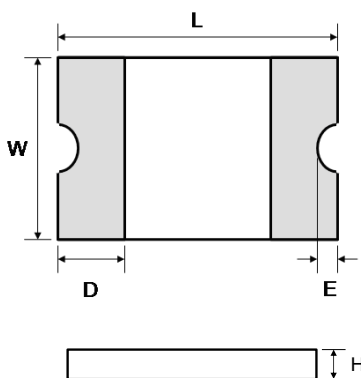

Fig. 1 Product scheme and dimensions.

Part Number	L (mm) Max.	W (mm) Max.	H (mm) Max.	D (mm) Min.	E (mm) Min.
PMS0805-010	2.20	1.50	1.00	0.20	0.10
PMS0805-020	2.20	1.50	1.00	0.20	0.10
PMS0805-025	2.20	1.50	1.00	0.20	0.10
PMS0805-035	2.20	1.50	1.00	0.20	0.10
PMS0805-050	2.20	1.50	0.60	0.20	0.10
PMS0805-075	2.20	1.50	1.10	0.20	0.10
PMS0805-100	2.20	1.50	1.10	0.20	0.10
PMS0805-110	2.20	1.50	1.10	0.20	0.10
PMS0805-125	2.20	1.50	1.20	0.20	0.10

Typical Ratings and Characteristics (@ 25°C):

✧ Operating temperature: -40 to +85°C

Part Number	Current (A)		V _{Max} (Vdc)	I _{Max} (A)	Max. Time to Trip (sec)		Typical Power (Pd, W)	Resistance Min. (Ω)	One Hours Post Reflow Resistance R ₁ Max. (Ω) ¹	UL Certification
	Hold (I _H)	Trip (I _T)			Current (A)	Time (sec)				
PMS0805-010	0.10	0.30	15	100	0.5	1.50	0.50	1.000	6.000	
PMS0805-020	0.20	0.50	9	100	8.0	0.02	0.50	0.650	3.500	√
PMS0805-025	0.25	0.55	9	100	8.0	0.02	0.50	0.600	3.000	
PMS0805-035	0.35	0.75	6	100	8.0	0.10	0.50	0.250	1.200	√
PMS0805-050	0.50	1.00	6	100	8.0	0.10	0.50	0.150	0.850	√
PMS0805-075	0.75	1.50	6	40	8.0	0.20	0.60	0.090	0.385	√
PMS0805-100	1.00	1.95	6	100	8.0	0.30	0.60	0.060	0.230	√
PMS0805-110	1.10	2.20	6	100	8.0	0.30	0.60	0.060	0.210	√
PMS0805-125	1.25	2.50	6	100	8.0	0.60	1.50	0.030	0.140	

¹ The max resistance of one-hour post reflow is a reference value. The value may change a little according to reflow conditions and soldering state.

Packaging and Marking Information:

Part Number	Part Marking	Tape & Reel Quantity (piece)
PMS0805-010	1	5,000
PMS0805-020	2	
PMS0805-025	2	
PMS0805-035	3	
PMS0805-050	5	
PMS0805-075	7	4,000
PMS0805-100	0	
PMS0805-110	0	
PMS0805-125	12	

Thermal De-rating Hold Current (A) at Ambient Temperature (25°C):

Part Number	Ambient temperature								
	-40°C	-20°C	0°C	25°C	40°C	50°C	60°C	70°C	85°C
PMS0805-010	0.14	0.12	0.11	0.10	0.08	0.07	0.06	0.05	0.03
PMS0805-020	0.28	0.25	0.23	0.20	0.17	0.14	0.12	0.10	0.07
PMS0805-025	0.35	0.31	0.27	0.25	0.22	0.19	0.16	0.14	0.11
PMS0805-035	0.47	0.44	0.39	0.35	0.30	0.27	0.24	0.20	0.14
PMS0805-050	0.68	0.62	0.55	0.50	0.40	0.37	0.33	0.29	0.23
PMS0805-075	1.00	0.90	0.79	0.75	0.63	0.57	0.53	0.41	0.34
PMS0805-100	1.35	1.25	1.15	1.00	0.82	0.74	0.65	0.55	0.42
PMS0805-110	1.45	1.35	1.20	1.10	0.92	0.84	0.75	0.65	0.52
PMS0805-125	1.65	1.53	1.36	1.25	1.05	0.95	0.85	0.74	0.59

Typical Time to Trip (@ 25°C):

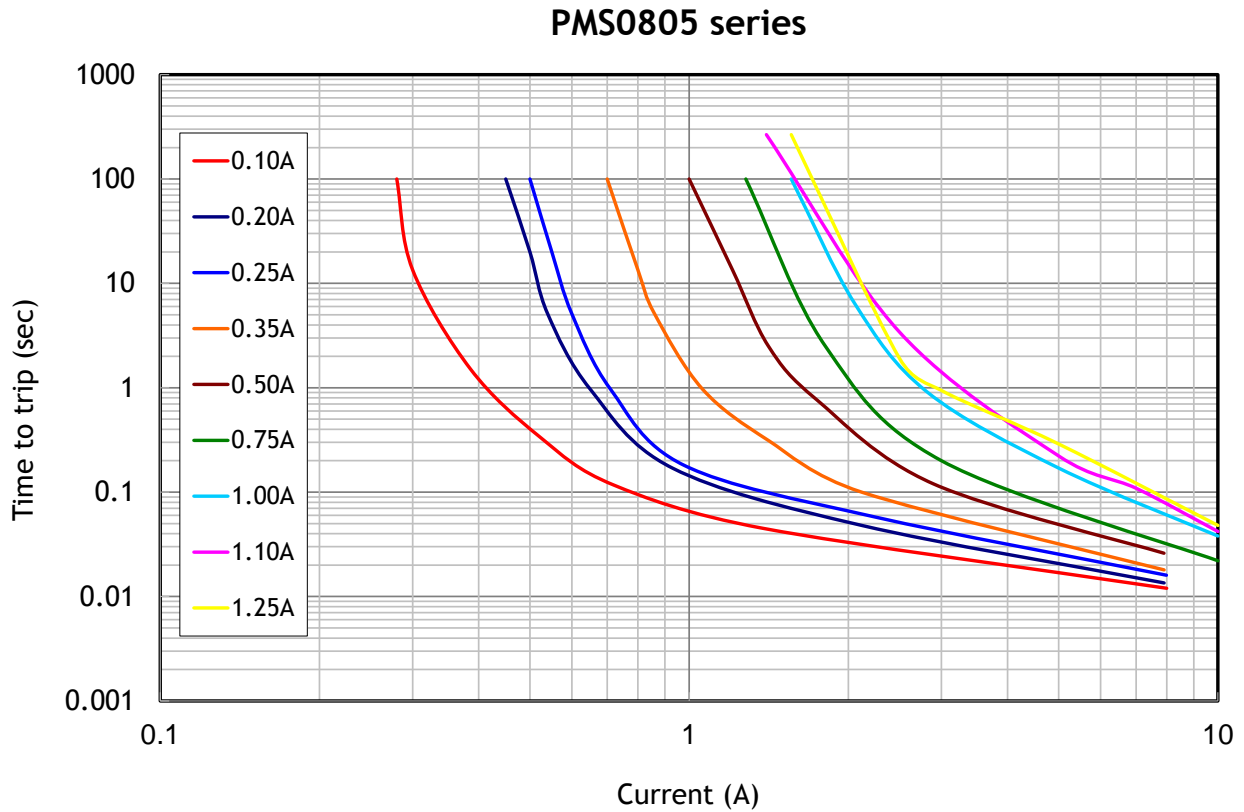

Recommended Foot Print Dimensions:

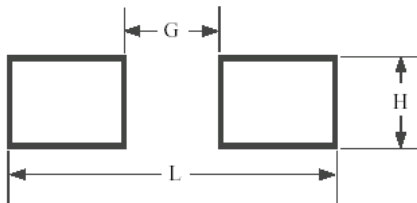

G (mm)	H (mm)	L (mm)
1.2	1.5	3.2

Fig. 2 Solder pads scheme and recommended dimensions.

Recommended Reflow Soldering Profile:

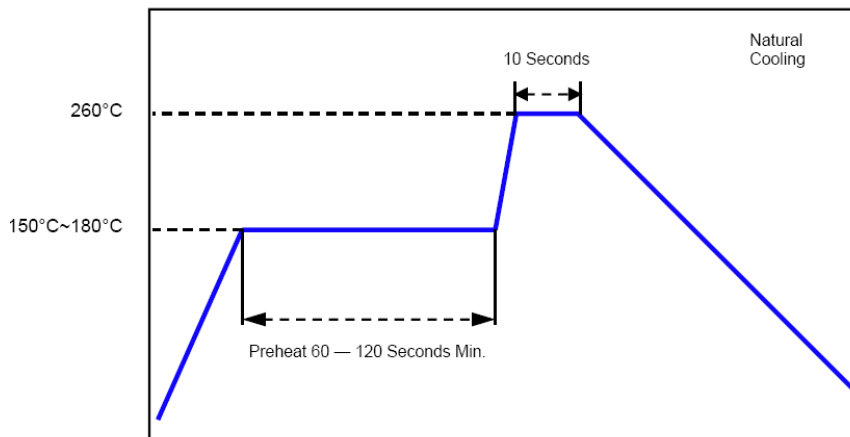

Fig. 3 Recommended reflow soldering profile

1. Recommended reflow methods: IR, hot air oven, nitrogen oven.
2. Recommended maximum paste thickness: 0.25mm (0.010 inch).
3. Devices can be cleaned using standard industry methods and solvents.
4. Soldering temperature and time should not exceed the recommended conditions.

Note: If reflow temperatures exceed the recommended profile, devices may not meet the performance requirements.

Caution: Operation beyond the rated voltage or current may result in rupture electrical arcing or flame.



WARNING:

- Operation beyond the maximum ratings or improper use may result in device damage and possible electrical arcing and flame.
- The devices are intended for protection against occasional over-current or over-temperature fault conditions and should not be used when repeated fault conditions or prolonged trip events are anticipated.
- Contamination of the PPTC material with certain silicon based oils or some aggressive solvents can adversely impact the performance of the devices.
- Device performance can be impacted negatively if devices are handled in a manner inconsistent with recommended electronic, thermal and mechanical procedures for electronic components.
- Operation in circuit with a large inductance can generate a circuit voltage ($L di/dt$) above the rated voltage of the PPTC device.

Surface Mount Polymer PTC

PMS Series, 1206 Size



Features:

- Resettable over-current protection
- Small size of 1206
- Fast time-to-trip
- RoHS compliant
- Halogen free

Applications:

- Battery packs
- Portable electronic devices
- Industrial controls
- Multimedia
- Game machines
- Telecom & broadband instruments

Ordering Code:

PMS 1206-012

(1) (2) (3)

- (1) Series code
 (2) Size code
 (3) Current rating code
 012: 0.12A

Agency Approval:

Recognized under the components program of UL.
 File number: E355716

Product Dimensions:

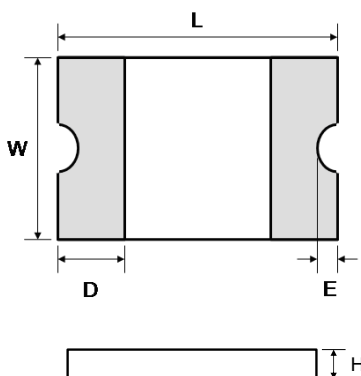

Fig. 1 Product scheme and dimensions.

Part Number	L (mm) Max.	W (mm) Max.	H (mm) Max.	D (mm) Min.	E (mm) Min.
PMS1206-005	3.50	1.80	1.10	0.15	0.10
PMS1206-010	3.50	1.80	1.10	0.15	0.10
PMS1206-012	3.50	1.80	1.10	0.15	0.10
PMS1206-020	3.50	1.80	0.90	0.15	0.10
PMS1206-025	3.50	1.80	0.90	0.15	0.10
PMS1206-035	3.50	1.80	0.90	0.15	0.10
PMS1206-050	3.50	1.80	0.85	0.15	0.10
PMS1206-075	3.50	1.80	0.80	0.15	0.10
PMS1206-100	3.50	1.80	0.80	0.15	0.10
PMS1206-110	3.50	1.80	0.80	0.15	0.10
PMS1206-150	3.50	1.80	1.20	0.15	0.10
PMS1206-200	3.50	1.80	1.20	0.15	0.10

Typical Ratings and Characteristics (@ 25°C):

✧ Operating temperature: -40 to +85°C

Part Number	Current (A)		V _{Max} (Vdc)	I _{Max} (A)	Max. Time to Trip (sec)		Typical Power (Pd, W)	Resistance Min. (Ω)	One Hours Post Reflow Resistance R ₁ Max. (Ω) ¹	UL Certification
	Hold (I _H)	Trip (I _T)			Current (A)	Time (sec)				
PMS1206-005	0.05	0.15	60	100	0.25	1.50	0.4	3.60	50.00	
PMS1206-010	0.10	0.25	60	100	0.5	1.00	0.4	1.60	15.00	
PMS1206-012	0.12	0.29	60	100	0.5	1.00	0.4	1.60	15.00	
PMS1206-020	0.20	0.40	30	100	8.0	0.08	0.6	0.35	2.500	
PMS1206-025	0.25	0.50	16	100	8.0	0.08	0.6	0.35	2.500	√
PMS1206-035	0.35	0.75	6	100	8.0	0.10	0.6	0.25	1.300	√
PMS1206-050	0.50	1.00	6	100	8.0	0.10	0.6	0.15	0.700	√
PMS1206-075	0.75	1.50	6	100	8.0	0.20	0.6	0.090	0.500	√
PMS1206-100	1.00	1.80	6	100	8.0	0.30	0.6	0.055	0.270	√
PMS1206-110	1.10	2.20	6	100	8.0	0.30	0.6	0.050	0.250	√
PMS1206-150	1.50	3.00	6	100	8.0	1.00	0.8	0.040	0.130	√
PMS1206-200	2.00	3.50	6	100	8.0	1.50	0.8	0.018	0.080	

¹ The max resistance of one-hour post reflow is a reference value. The value may change a little according to reflow conditions and soldering state.

Packaging and Marking Information:

Part Number	Part Marking	Tape & Reel Quantity (piece)
PMS1206-005	αZ	5,000
PMS1206-010	αN	
PMS1206-012	αN	
PMS1206-020	αA	
PMS1206-025	αA	
PMS1206-035	αB	
PMS1206-050	αF	
PMS1206-075	αG	
PMS1206-100	αH	
PMS1206-110	αH	
PMS1206-150	αI	3,500
PMS1206-200	αK	

Thermal De-rating Hold Current (A) at Ambient Temperature (25°C):

Part Number	Ambient temperature								
	-40°C	-20°C	0°C	25°C	40°C	50°C	60°C	70°C	85°C
PMS1206-005	0.074	0.066	0.058	0.050	0.0425	0.038	0.035	0.030	0.0275
PMS1206-010	0.15	0.13	0.12	0.10	0.085	0.075	0.07	0.06	0.055
PMS1206-012	0.18	0.16	0.14	0.12	0.10	0.09	0.08	0.07	0.065
PMS1206-020	0.30	0.26	0.23	0.20	0.17	0.15	0.14	0.12	0.11
PMS1206-025	0.37	0.33	0.29	0.25	0.22	0.20	0.17	0.15	0.12
PMS1206-035	0.50	0.45	0.40	0.35	0.30	0.27	0.24	0.21	0.15
PMS1206-050	0.71	0.64	0.57	0.50	0.42	0.39	0.35	0.31	0.25
PMS1206-075	1.14	1.01	0.88	0.75	0.65	0.59	0.54	0.49	0.41
PMS1206-100	1.45	1.31	1.15	1.00	0.84	0.77	0.69	0.61	0.48
PMS1206-110	1.60	1.45	1.30	1.10	0.95	0.80	0.72	0.66	0.55
PMS1206-150	2.18	1.94	1.72	1.50	1.28	1.17	1.06	0.96	0.77
PMS1206-200	2.88	2.63	2.34	2.00	1.74	1.58	1.42	1.17	0.93

Typical Time to Trip (@ 25°C):

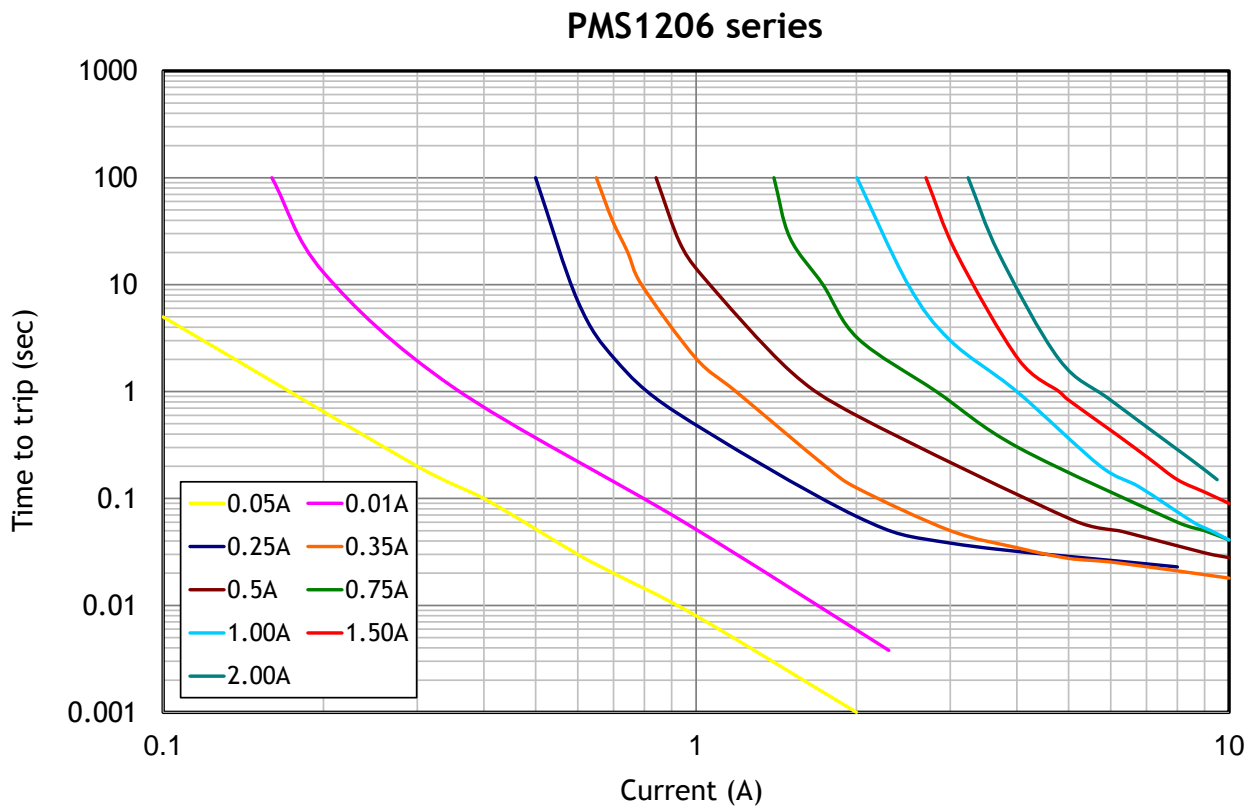

Recommended Foot Print Dimensions:

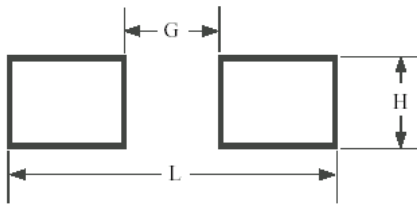

G (mm)	H (mm)	L (mm)
1.8	1.8	3.8

Fig. 2 Solder pads scheme and recommended dimensions.

Recommended Reflow Soldering Profile:

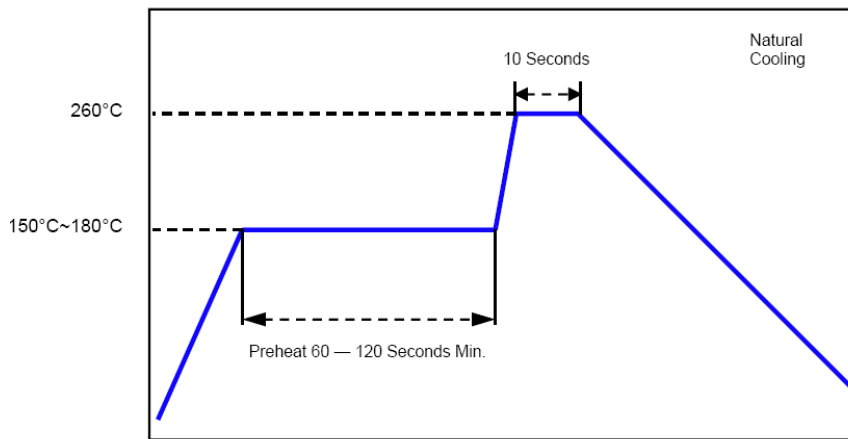

Fig. 3 Recommended reflow soldering profile

1. Recommended reflow methods: IR, hot air oven, nitrogen oven.
2. Recommended maximum paste thickness: 0.25mm (0.010 inch).
3. Devices can be cleaned using standard industry methods and solvents.
4. Soldering temperature and time should not exceed the recommended conditions.

Note: If reflow temperatures exceed the recommended profile, devices may not meet the performance requirements.

Caution: Operation beyond the rated voltage or current may result in rupture electrical arcing or flame.



WARNING:

- Operation beyond the maximum ratings or improper use may result in device damage and possible electrical arcing and flame.
- The devices are intended for protection against occasional over-current or over-temperature fault conditions and should not be used when repeated fault conditions or prolonged trip events are anticipated.
- Contamination of the PPTC material with certain silicon based oils or some aggressive solvents can adversely impact the performance of the devices.
- Device performance can be impacted negatively if devices are handled in a manner inconsistent with recommended electronic, thermal and mechanical procedures for electronic components.
- Operation in circuit with a large inductance can generate a circuit voltage ($L di/dt$) above the rated voltage of the PPTC device.

Surface Mount Polymer PTC

PMS Series, 1210 Size



Features:

- Resettable over-current protection
- Small size of 1210
- Fast time-to-trip
- RoHS compliant
- Halogen free

Applications:

- Battery packs
- Portable electronic devices
- Industrial controls
- Multimedia
- Game machines
- Telecom & broadband instruments

Ordering Code:

PMS 1210-175

(1) (2) (3)

- (1) Series code
 (2) Size code
 (3) Current rating code
 175: 1.75A

Agency Approval:

Recognized under the components program of UL.
 File number: E355716

Product Dimensions:

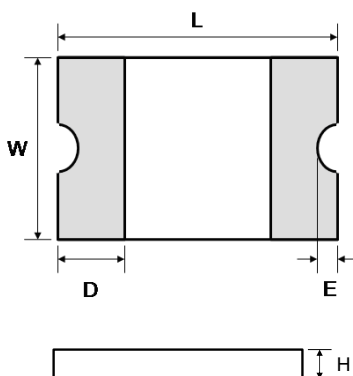

Fig. 1 Product scheme and dimensions.

Part Number	L (mm)	W (mm)	H (mm)	D (mm)
	Max.	Max.	Max.	Min.
PMS1210-005	3.43	2.80	0.80	0.30
PMS1210-010	3.43	2.80	0.80	0.30
PMS1210-020	3.43	2.80	0.80	0.30
PMS1210-035	3.43	2.80	0.80	0.30
PMS1210-050-06	3.43	2.80	0.80	0.30
PMS1210-050	3.43	2.80	0.80	0.30
PMS1210-075	3.43	2.80	0.80	0.30
PMS1210-100	3.43	2.80	0.80	0.30
PMS1210-110	3.43	2.80	0.80	0.30
PMS1210-150	3.43	2.80	0.80	0.30
PMS1210-175	3.43	2.80	0.80	0.30
PMS1210-200	3.43	2.80	1.20	0.30

Typical Ratings and Characteristics (@ 25°C):

✧ Operating temperature: -40 to +85°C

Part Number	Current (A)		V _{Max} (Vdc)	I _{Max} (A)	Max. Time to Trip (sec)		Typical Power (Pd, W)	Resistance Min. (Ω)	One Hours Post Reflow Resistance R ₁ Max. (Ω) ¹	UL Certification
	Hold (I _H)	Trip (I _T)			Current (A)	Time (sec)				
PMS1210-005	0.05	0.15	30	100	0.25	1.50	0.6	2.800	50.00	
PMS1210-010	0.10	0.30	30	100	0.50	0.60	0.6	0.800	15.00	
PMS1210-020	0.20	0.40	30	100	8.0	0.02	0.6	0.400	5.00	
PMS1210-035	0.35	0.75	6	100	8.0	0.20	0.6	0.200	1.300	√
PMS1210-050-06	0.50	1.00	6	100	8.0	0.10	0.6	0.180	0.900	√
PMS1210-050	0.50	1.00	13.2	100	8.0	0.10	0.6	0.180	0.900	
PMS1210-075	0.75	1.50	6	100	8.0	0.10	0.6	0.070	0.400	√
PMS1210-100	1.00	1.80	6	100	8.0	0.30	0.6	0.055	0.230	
PMS1210-110	1.10	2.20	6	100	8.0	0.30	0.6	0.050	0.210	√
PMS1210-150	1.50	3.00	6	100	8.0	0.50	0.6	0.030	0.110	√
PMS1210-175	1.75	3.50	6	100	8.0	0.60	0.8	0.020	0.080	
PMS1210-200	2.00	4.00	6	100	8.0	1.00	0.8	0.015	0.070	

¹ The max resistance of one-hour post reflow is a reference value. The value may change a little according to reflow conditions and soldering state.

Packaging and Marking Information:

Part Number	Part Marking	Tape & Reel Quantity (piece)
PMS1210-005	αA	4,500
PMS1210-010	αB	
PMS1210-020	αC	
PMS1210-035	αD	
PMS1210-050-06	αF	4,000
PMS1210-050	αF	
PMS1210-075	αG	
PMS1210-100	αH	4,500
PMS1210-110	αH	
PMS1210-150	αL	
PMS1210-175	αN	
PMS1210-200	αS	

Thermal De-rating Hold Current (A) at Ambient Temperature (25°C):

Part Number	Ambient temperature								
	-40°C	-20°C	0°C	25°C	40°C	50°C	60°C	70°C	85°C
PMS1210-005	0.08	0.07	0.06	0.05	0.04	0.04	0.03	0.03	0.02
PMS1210-010	0.16	0.14	0.12	0.10	0.08	0.07	0.06	0.05	0.03
PMS1210-020	0.29	0.26	0.22	0.20	0.16	0.14	0.13	0.11	0.08
PMS1210-035	0.47	0.45	0.40	0.35	0.33	0.28	0.24	0.21	0.18
PMS1210-050-06	0.76	0.67	0.58	0.50	0.43	0.40	0.36	0.32	0.28
PMS1210-050	0.76	0.67	0.58	0.50	0.43	0.40	0.36	0.32	0.28
PMS1210-075	1.00	0.97	0.86	0.75	0.64	0.59	0.54	0.48	0.40
PMS1210-100	1.54	1.35	1.18	1.00	0.76	0.67	0.53	0.45	0.31
PMS1210-110	1.69	1.48	1.29	1.10	0.88	0.76	0.65	0.57	0.43
PMS1210-150	2.13	1.92	1.71	1.50	1.26	1.14	1.01	0.89	0.71
PMS1210-175	2.54	2.30	2.02	1.75	1.47	1.33	1.18	1.05	0.86
PMS1210-200	2.90	2.63	2.31	2.00	1.68	1.52	1.35	1.20	0.98

Typical Time to Trip (@ 25°C):

PMS1210 series

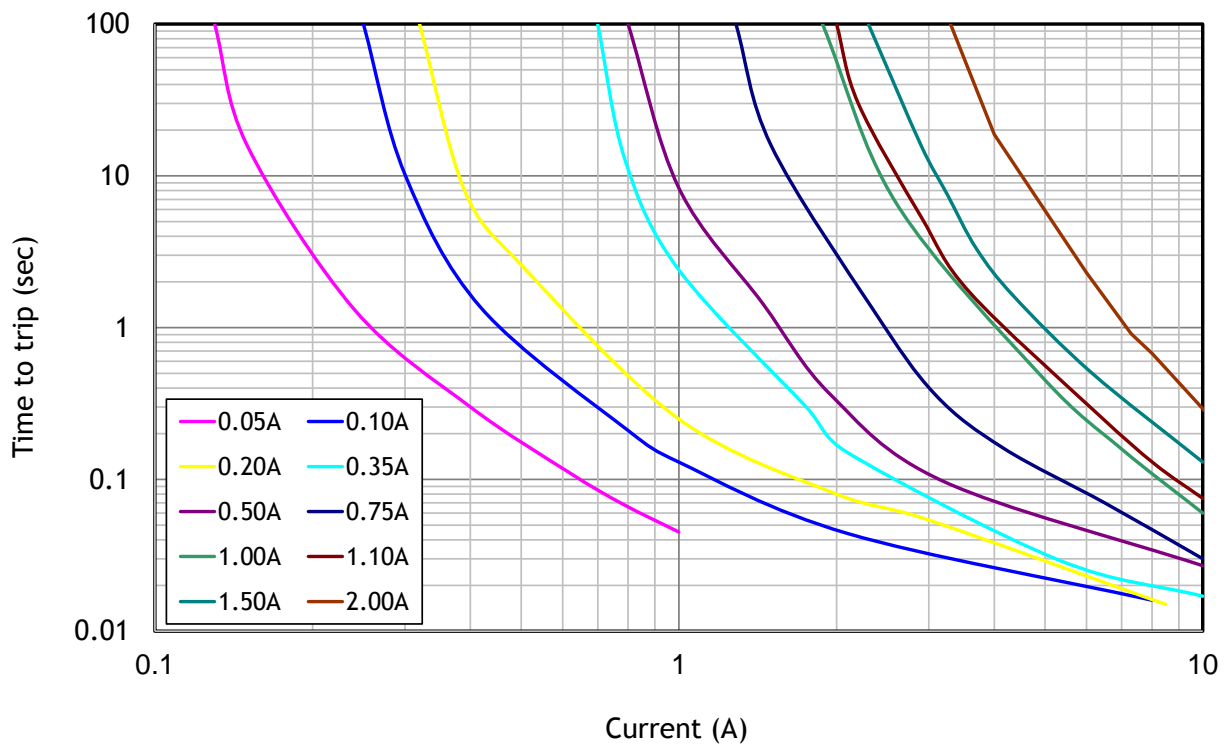

Recommended Foot Print Dimensions:

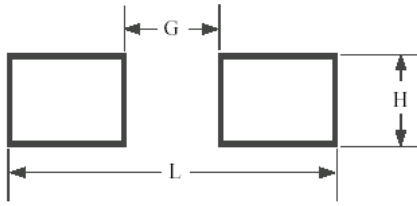

G (mm)	H (mm)	L (mm)
1.8	2.8	3.8

Fig. 2 Solder pads scheme and recommended dimensions.

Recommended Reflow Soldering Profile:

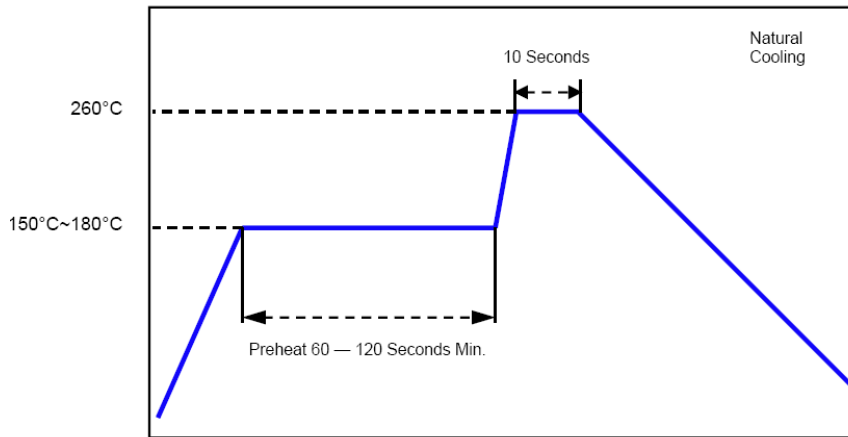

Fig. 3 Recommended reflow soldering profile

1. Recommended reflow methods: IR, hot air oven, nitrogen oven.
2. Recommended maximum paste thickness: 0.25mm (0.010 inch).
3. Devices can be cleaned using standard industry methods and solvents.
4. Soldering temperature and time should not exceed the recommended conditions.

Note: If reflow temperatures exceed the recommended profile, devices may not meet the performance requirements.

Caution: Operation beyond the rated voltage or current may result in rupture electrical arcing or flame.



WARNING:

- Operation beyond the maximum ratings or improper use may result in device damage and possible electrical arcing and flame.
- The devices are intended for protection against occasional over-current or over-temperature fault conditions and should not be used when repeated fault conditions or prolonged trip events are anticipated.
- Contamination of the PPTC material with certain silicon based oils or some aggressive solvents can adversely impact the performance of the devices.
- Device performance can be impacted negatively if devices are handled in a manner inconsistent with recommended electronic, thermal and mechanical procedures for electronic components.
- Operation in circuit with a large inductance can generate a circuit voltage ($L di/dt$) above the rated voltage of the PPTC device.

Surface Mount Polymer PTC

PMS Series, 1812 Size



Features:

- Resettable over-current protection
- Small size of 1812
- Fast time-to-trip
- RoHS compliant
- Halogen free

Applications:

- Battery packs
- Portable electronic devices
- Industrial controls
- Multimedia
- Game machines
- Telecom & broadband instruments

Ordering Code:

PMS 1812-150

(1) (2) (3)

- (1) Series code
 (2) Size code
 (3) Current rating code
 150: 1.5A

Agency Approval:

Recognized under the components program of UL.
 File number: E355716

Product Dimensions:

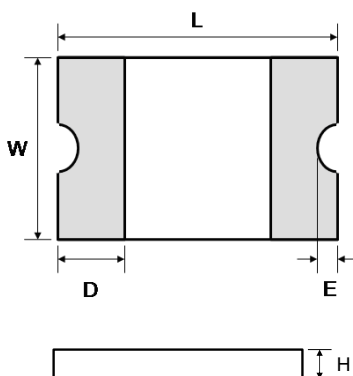

Fig. 1 Product scheme and dimensions.

Part Number	L (mm) Max.	W (mm) Max.	H (mm) Max.	D (mm) Min.	E (mm) Min.
PMS1812-010	4.73	3.41	1.00	0.30	0.25
PMS1812-014	4.73	3.41	1.00	0.30	0.25
PMS1812-020	4.73	3.41	1.30	0.30	0.25
PMS1812-030	4.73	3.41	1.00	0.30	0.25
PMS1812-050	4.73	3.41	0.90	0.30	0.25
PMS1812-075	4.73	3.41	0.90	0.30	0.25
PMS1812-100	4.73	3.41	0.90	0.30	0.25
PMS1812-110	4.73	3.41	0.90	0.30	0.25
PMS1812-125	4.73	3.41	1.30	0.30	0.25
PMS1812-150	4.73	3.41	0.90	0.30	0.25
PMS1812-160	4.73	3.41	0.90	0.30	0.25
PMS1812-200	4.73	3.41	1.30	0.30	0.25
PMS1812-260	4.73	3.41	1.30	0.30	0.25
PMS1812-300	4.73	3.41	1.30	0.30	0.25
PMS1812-350	4.73	3.41	1.30	0.30	0.25
PMS1812-375	4.73	3.41	1.80	0.30	0.25

Typical Ratings and Characteristics (@ 25°C):

✧ Operating temperature: -40 to +85°C

Part Number	Current (A)		V _{Max} (Vdc)	I _{Max} (A)	Max. Time to Trip (sec)		Typical Power (Pd, W)	Resistance Min. (Ω)	One Hours Post Reflow Resistance R ₁ Max. (Ω) ¹	UL Certification
	Hold (I _H)	Trip (I _T)			Current (A)	Time (sec)				
PMS1812-010	0.10	0.30	30	100	0.5	1.50	0.8	0.750	15.0	√
PMS1812-014	0.14	0.34	60	100	1.5	0.15	0.8	0.650	6.00	
PMS1812-020	0.20	0.40	30	100	8.0	0.02	0.8	0.350	5.00	
PMS1812-030	0.30	0.60	30	100	8.0	0.10	0.8	0.250	3.00	
PMS1812-050	0.50	1.00	15	100	8.0	0.15	0.8	0.150	1.00	√
PMS1812-075	0.75	1.50	13.2	100	8.0	0.20	0.8	0.090	0.450	√
PMS1812-100	1.00	1.80	8	100	8.0	0.30	0.8	0.055	0.270	
PMS1812-110	1.10	2.20	8	100	8.0	0.30	0.8	0.050	0.250	√
PMS1812-125	1.25	2.50	16	100	8.0	0.40	0.8	0.050	0.140	
PMS1812-150	1.50	3.00	8	100	8.0	0.50	0.8	0.040	0.160	√
PMS1812-160	1.60	2.80	8	100	8.0	1.00	0.8	0.030	0.130	√
PMS1812-200	2.00	4.00	8	100	8.0	2.00	0.8	0.020	0.100	√
PMS1812-260	2.60	5.00	8	100	8.0	2.50	0.8	0.015	0.050	√
PMS1812-300	3.00	5.00	8	100	8.0	4.00	0.8	0.012	0.040	
PMS1812-350	3.50	6.00	6	100	10.0	4.00	2.0	0.008	0.030	
PMS1812-375	3.75	7.00	6	100	12.0	4.00	2.0	0.007	0.028	

¹ The max resistance of one-hour post reflow is a reference value. The value may change a little according to reflow conditions and soldering state.

Packaging and Marking Information:

Part Number	Part Marking	Tape & Reel Quantity (piece)
PMS1812-010	α010	1,500
PMS1812-014	α014	
PMS1812-020	α020	
PMS1812-030	α030	
PMS1812-050	α050	
PMS1812-075	α075	
PMS1812-100	α100	
PMS1812-110	α110	
PMS1812-125	α125	
PMS1812-150	α150	
PMS1812-160	α160	
PMS1812-200	α200	
PMS1812-260	α260	
PMS1812-300	α300	
PMS1812-350	α350	
PMS1812-375	α375	

Thermal De-rating Hold Current (A) at Ambient Temperature (25°C):

Part Number	Ambient temperature								
	-40°C	-20°C	0°C	25°C	40°C	50°C	60°C	70°C	85°C
PMS1812-010	0.16	0.14	0.12	0.10	0.08	0.07	0.06	0.05	0.03
PMS1812-014	0.23	0.19	0.17	0.14	0.12	0.10	0.09	0.08	0.06
PMS1812-020	0.29	0.26	0.23	0.20	0.17	0.15	0.14	0.12	0.10
PMS1812-030	0.44	0.39	0.35	0.30	0.26	0.23	0.21	0.18	0.15
PMS1812-050	0.59	0.57	0.55	0.50	0.45	0.43	0.35	0.30	0.23
PMS1812-075	1.10	0.99	0.87	0.75	0.63	0.57	0.49	0.45	0.35
PMS1812-100	1.45	1.32	1.16	1.00	0.84	0.75	0.68	0.60	0.48
PMS1812-110	1.60	1.45	1.28	1.10	0.92	0.83	0.71	0.66	0.52
PMS1812-125	2.00	1.75	1.52	1.25	1.00	0.95	0.90	0.75	0.53
PMS1812-150	2.30	2.05	1.77	1.50	1.23	1.09	0.95	0.82	0.61
PMS1812-160	2.40	2.15	1.88	1.60	1.26	1.12	0.98	0.84	0.63
PMS1812-200	2.88	2.61	2.25	2.00	1.80	1.66	1.45	1.09	0.80
PMS1812-260	3.90	3.42	2.96	2.60	2.33	2.07	1.94	1.35	1.00
PMS1812-300	4.15	3.76	3.46	3.00	2.55	2.28	2.01	1.61	1.33
PMS1812-350	5.04	4.57	3.94	3.50	3.15	2.91	2.54	1.91	1.40
PMS1812-375	5.45	4.94	4.36	3.75	3.14	2.83	2.54	2.25	1.82

Typical Time to Trip (@ 25°C):

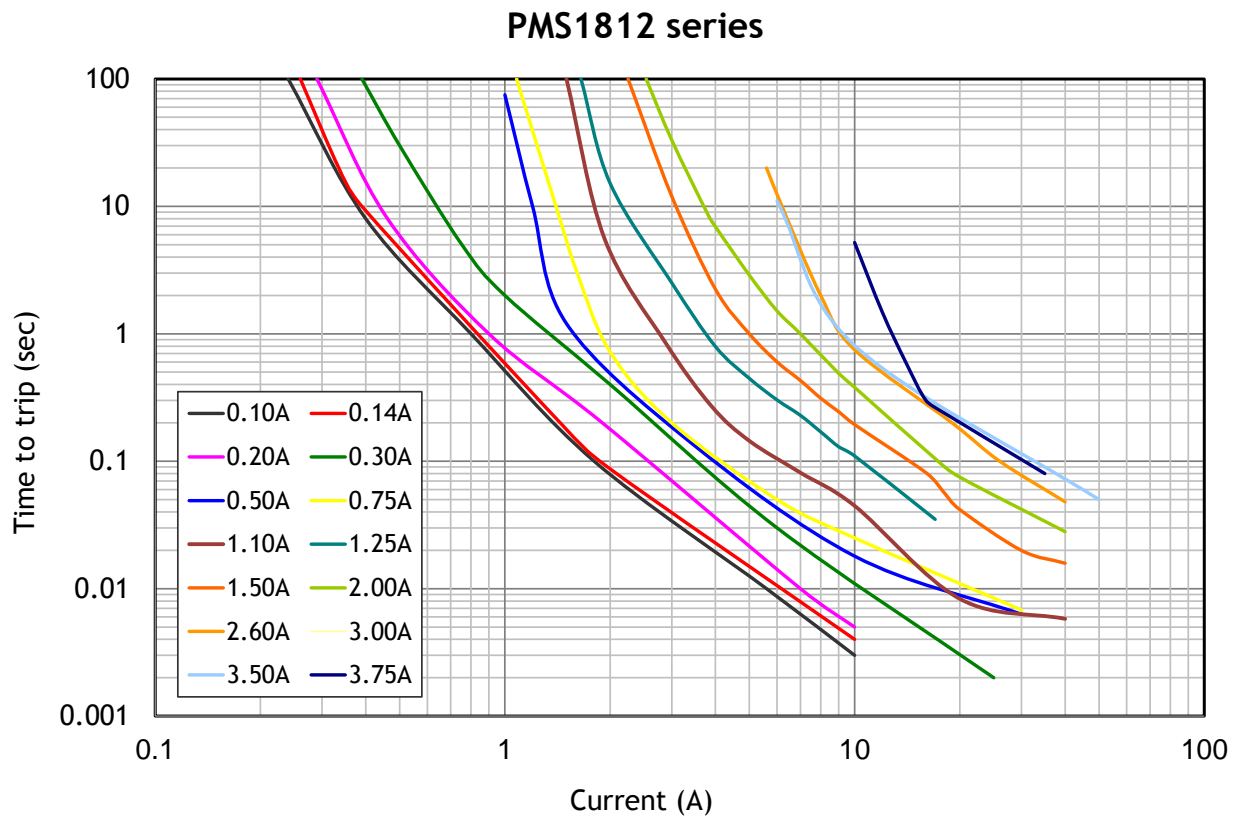

Recommended Foot Print Dimensions:

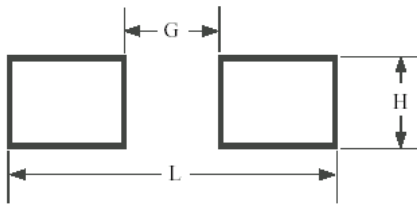

G (mm)	H (mm)	L (mm)
2.75	3.41	1.60

Fig. 2 Solder pads scheme and recommended dimensions.

Recommended Reflow Soldering Profile:

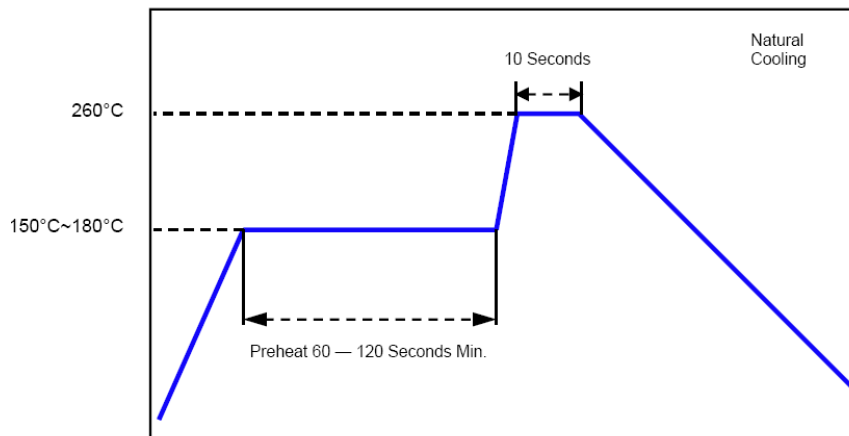

Fig. 3 Recommended reflow soldering profile

1. Recommended reflow methods: IR, hot air oven, nitrogen oven.
2. Recommended maximum paste thickness: 0.25mm (0.010 inch).
3. Devices can be cleaned using standard industry methods and solvents.
4. Soldering temperature and time should not exceed the recommended conditions.

Note: If reflow temperatures exceed the recommended profile, devices may not meet the performance requirements.

Caution: Operation beyond the rated voltage or current may result in rupture electrical arcing or flame.



WARNING:

- Operation beyond the maximum ratings or improper use may result in device damage and possible electrical arcing and flame.
- The devices are intended for protection against occasional over-current or over-temperature fault conditions and should not be used when repeated fault conditions or prolonged trip events are anticipated.
- Contamination of the PPTC material with certain silicon based oils or some aggressive solvents can adversely impact the performance of the devices.
- Device performance can be impacted negatively if devices are handled in a manner inconsistent with recommended electronic, thermal and mechanical procedures for electronic components.
- Operation in circuit with a large inductance can generate a circuit voltage ($L di/dt$) above the rated voltage of the PPTC device.

Surface Mount Polymer PTC

PMS Series, 2018 Size

Features:

- Resettable over-current protection
- Fast time-to-trip
- RoHS compliant
- Halogen free

Applications:

- Battery packs
- Portable electronic devices
- Industrial controls
- Multimedia
- Game machines
- Telecom & broadband instruments

Ordering Code:

PMS 2018-150

(1) (2) (3)

- (1) Series code
 - (2) Size code
 - (3) Current rating code
- 150: 1.5A

Product Dimensions:

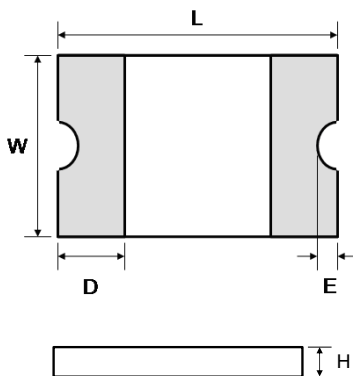

Part Number	L (mm) Max.	W (mm) Max.	H (mm) Max.	D (mm) Min.
PMS2018-030	5.44	4.93	1.10	0.30
PMS2018-050	5.44	4.93	1.30	0.30
PMS2018-100	5.44	4.93	0.80	0.30
PMS2018-150	5.44	4.93	0.80	0.30
PMS2018-200	5.44	4.93	0.80	0.30

Fig. 1 Product scheme and dimensions.

Typical Ratings and Characteristics (@ 25°C):

✧ Operating temperature: -40 to +85°C

Part Number	Current (A)		V _{Max} (Vdc)	I _{Max} (A)	Max. Time to Trip (sec)		Typical Power (Pd, W)	Resistance Min. (Ω)	One Hours Post Reflow Resistance R ₁ Max. (Ω) ¹
	Hold (I _H)	Trip (I _T)			Current (A)	Time (sec)			
PMS2018-030	0.30	0.60	60	100	1.5	3.00	0.9	0.500	2.300
PMS2018-050	0.55	1.20	60	100	2.5	3.00	1.0	0.200	1.000
PMS2018-100	1.10	2.20	15	100	8.0	0.40	1.1	0.060	0.360
PMS2018-150	1.50	3.00	15	100	8.0	0.80	1.1	0.050	0.170
PMS2018-200	2.00	4.00	10	100	8.0	2.40	1.1	0.030	0.100

¹ The max resistance of one-hour post reflow is a reference value. The value may change a little according to reflow conditions and soldering state.

Packaging and Marking Information:

Part Number	Part Marking	Tape & Reel Quantity (piece)
PMS2018-030	α030	1,500
PMS2018-050	α050	
PMS2018-100	α100	2,500
PMS2018-150	α150	
PMS2018-200	α200	

Recommended Foot Print Dimensions:

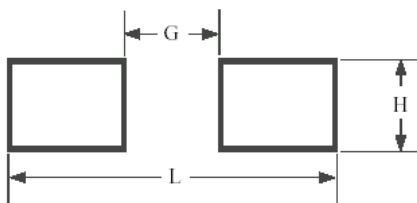

G (mm)	H (mm)	L (mm)
3.15	4.90	6.35

Fig. 2 Solder pads scheme and recommended dimensions.

Thermal De-rating Hold Current (A) at Ambient Temperature (25°C):

Part Number	Ambient temperature								
	-40°C	-20°C	0°C	25°C	40°C	50°C	60°C	70°C	85°C
PMS2018-030	0.48	0.42	0.35	0.30	0.24	0.21	0.17	0.15	0.10
PMS2018-050	0.87	0.77	0.67	0.55	0.46	0.41	0.36	0.31	0.23
PMS2018-100	1.71	1.52	1.32	1.10	0.94	0.84	0.74	0.64	0.50
PMS2018-150	2.38	2.10	1.82	1.50	1.27	1.13	0.99	0.85	0.64
PMS2018-200	2.95	2.65	2.35	2.00	1.74	1.59	1.44	1.29	1.06

Typical Time to Trip (@ 25°C):

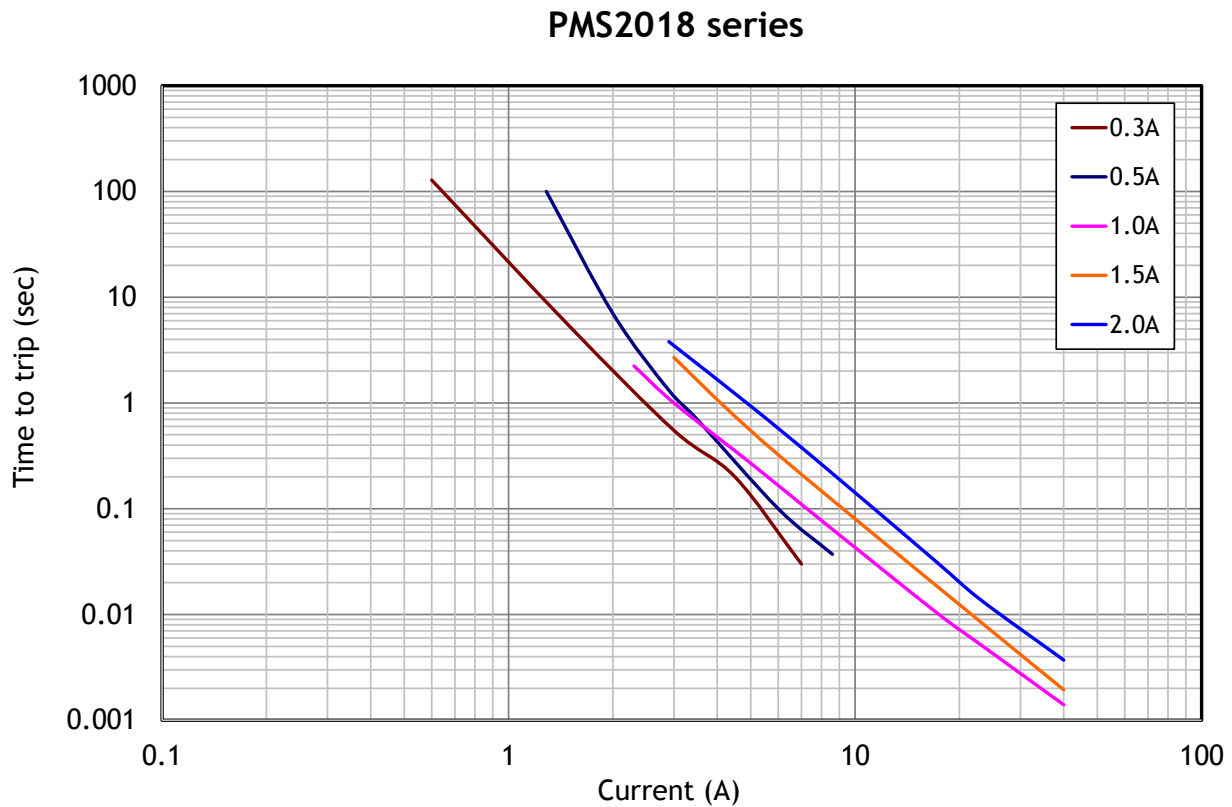

Recommended Reflow Soldering Profile:

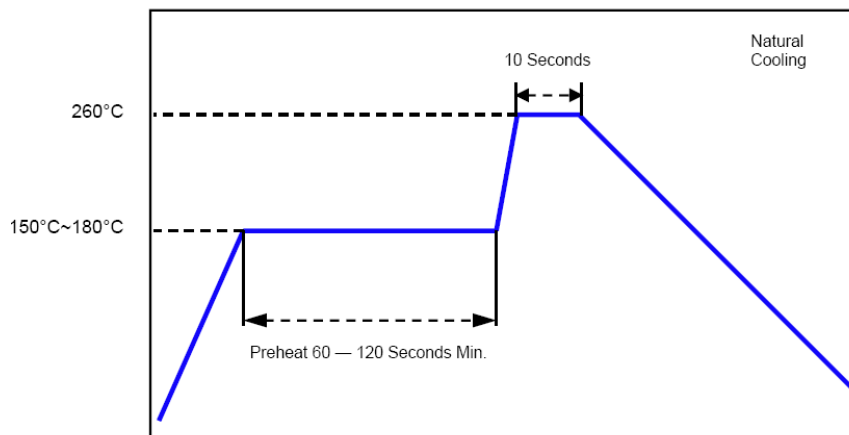

Fig. 3 Recommended reflow soldering profile

1. Recommended reflow methods: IR, hot air oven, nitrogen oven.
2. Recommended maximum paste thickness: 0.25mm (0.010 inch).
3. Devices can be cleaned using standard industry methods and solvents.
4. Soldering temperature and time should not exceed the recommended conditions.

Note: If reflow temperatures exceed the recommended profile, devices may not meet the performance requirements.

Caution: Operation beyond the rated voltage or current may result in rupture electrical arcing or flame.

**WARNING:**

- Operation beyond the maximum ratings or improper use may result in device damage and possible electrical arcing and flame.
- The devices are intended for protection against occasional over-current or over-temperature fault conditions and should not be used when repeated fault conditions or prolonged trip events are anticipated.
- Contamination of the PPTC material with certain silicon based oils or some aggressive solvents can adversely impact the performance of the devices.
- Device performance can be impacted negatively if devices are handled in a manner inconsistent with recommended electronic, thermal and mechanical procedures for electronic components.
- Operation in circuit with a large inductance can generate a circuit voltage ($L di/dt$) above the rated voltage of the PPTC device.

Surface Mount Polymer PTC

PMS Series, 2920 Size



Features:

- Resettable over-current protection
- Fast time-to-trip
- RoHS compliant
- Halogen free

Applications:

- Battery packs
- Portable electronic devices
- Industrial controls
- Multimedia
- Game machines
- Telecom & broadband instruments

Ordering Code:

PMS 2920-300-06

(1) (2) (3) (4)

- (1) Series code
- (2) Size code
- (3) Current rating code
300: 3.0A
- (4) Rating voltage code
06: 6Vdc

Agency Approval:

Recognized under the components program of UL.
File number: E355716

Product Dimensions:

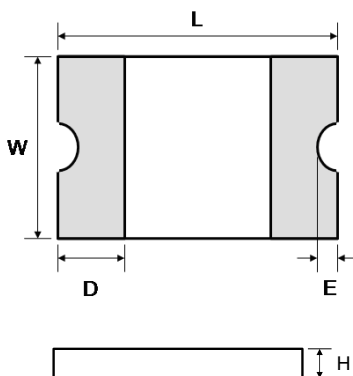

Fig. 1 Product scheme and dimensions.

Part Number	L (mm) Max.	W (mm) Max.	H (mm) Max.	D (mm) Min.
PMS2920-030	7.98	5.44	1.15	0.30
PMS2920-050	7.98	5.44	1.15	0.30
PMS2920-075	7.98	5.44	1.15	0.30
PMS2920-100	7.98	5.44	1.00	0.30
PMS2920-125	7.98	5.44	0.90	0.30
PMS2920-150	7.98	5.44	0.90	0.30
PMS2920-185	7.98	5.44	0.90	0.30
PMS2920-200	7.98	5.44	0.90	0.30
PMS2920-250	7.98	5.44	0.90	0.30
PMS2920-260	7.98	5.44	0.90	0.30
PMS2920-300-06	7.98	5.44	0.90	0.30
PMS2920-300	7.98	5.44	0.90	0.30

Typical Ratings and Characteristics (@ 25°C):

✧ Operating temperature: -40 to +85°C

Part Number	Current (A)		V _{Max} (Vdc)	I _{Max} (A)	Max. Time to Trip (sec)		Typical Power (Pd, W)	Resistance Min. (Ω)	One Hours Post Reflow Resistance R ₁ Max. (Ω) ¹	UL Certification
	Hold (I _H)	Trip (I _T)			Current (A)	Time (sec)				
PMS2920-030	0.30	0.60	60	100	1.5	3.0	1.50	0.600	4.80	
PMS2920-050	0.50	1.00	60	100	2.5	4.0	1.50	0.180	1.40	
PMS2920-075	0.75	1.50	33	100	8.0	0.3	1.50	0.100	1.00	
PMS2920-100	1.10	2.20	33	100	8.0	0.5	1.50	0.065	0.410	
PMS2920-125	1.25	2.50	33	100	8.0	2.0	1.50	0.050	0.250	
PMS2920-150	1.50	3.00	33	100	8.0	2.0	1.50	0.035	0.230	
PMS2920-185	1.85	3.75	33	100	8.0	2.5	1.50	0.030	0.150	
PMS2920-200	2.00	4.00	16	100	8.0	4.5	1.50	0.020	0.120	
PMS2920-250	2.50	5.00	16	100	8.0	16.0	1.50	0.020	0.085	
PMS2920-260	2.60	5.20	6	100	8.0	10.0	1.50	0.014	0.075	
PMS2920-300-06	3.00	6.00	6	40	8.0	20.0	1.50	0.012	0.048	
PMS2920-300	3.00	6.00	16	100	8.0	20.0	1.50	0.012	0.048	√

¹ The max resistance of one-hour post reflow is a reference value. The value may change a little according to reflow conditions and soldering state.

Packaging and Marking Information:

Part Number	Part Marking	Tape & Reel Quantity (piece)
PMS2920-030	α030L	2,000
PMS2920-050	α050L	
PMS2920-075	α075L	
PMS2920-100	α100L	
PMS2920-125	α125L	
PMS2920-150	α150L	
PMS2920-185	α185L	
PMS2920-200	α200L	
PMS2920-250	α250L	
PMS2920-260	α260L	
PMS2920-300-06	α300L	
PMS2920-300	α300L	

Thermal De-rating Hold Current (A) at Ambient Temperature (25°C):

Part Number	Ambient temperature								
	-40°C	-20°C	0°C	25°C	40°C	50°C	60°C	70°C	85°C
PMS2920-030	0.45	0.40	0.35	0.30	0.25	0.23	0.20	0.17	0.14
PMS2920-050	0.76	0.67	0.59	0.50	0.42	0.38	0.33	0.29	0.23
PMS2920-075	1.13	1.01	0.88	0.75	0.62	0.56	0.50	0.44	0.34
PMS2920-100	1.66	1.47	1.29	1.10	0.91	0.83	0.73	0.64	0.50
PMS2920-125	1.89	1.68	1.46	1.25	1.04	0.94	0.83	0.73	0.56
PMS2920-150	2.27	2.01	1.76	1.50	1.25	1.13	1.00	0.87	0.74
PMS2920-185	2.80	2.47	2.17	1.85	1.54	1.39	1.22	1.07	0.85
PMS2920-200	3.02	2.68	2.34	2.00	1.66	1.50	1.32	1.16	0.90
PMS2920-250	3.78	3.35	2.93	2.50	2.08	1.88	1.65	1.45	1.13
PMS2920-260	3.64	3.25	2.91	2.60	2.26	2.08	1.95	1.74	1.13
PMS2920-300-06	4.53	4.02	3.51	3.00	2.52	2.26	1.99	1.75	1.34
PMS2920-300	4.53	4.02	3.51	3.00	2.52	2.26	1.99	1.75	1.34

Typical Time to Trip (@ 25°C):

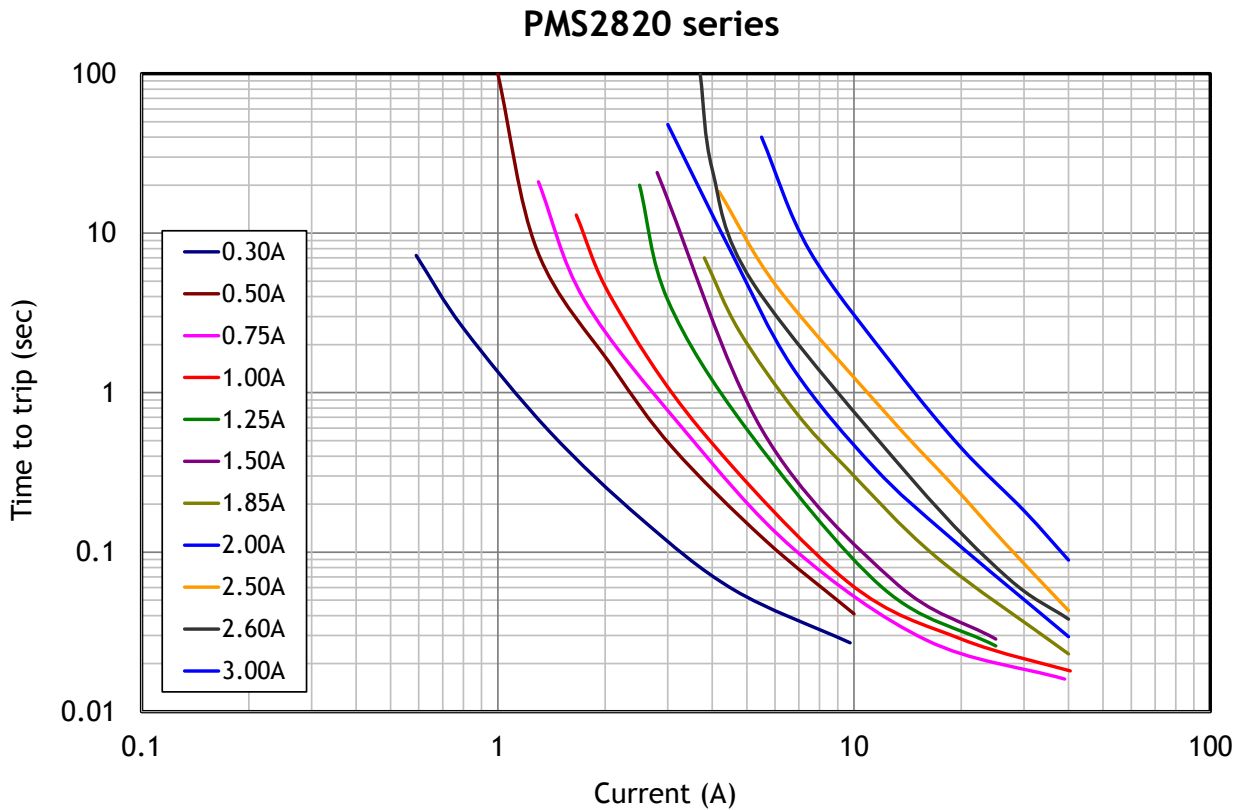

Recommended Foot Print Dimensions:

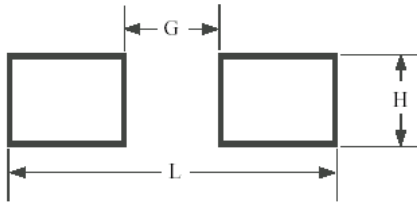

G (mm)	H (mm)	L (mm)
4.60	5.50	8.60

Fig. 2 Solder pads scheme and recommended dimensions.

Recommended Reflow Soldering Profile:

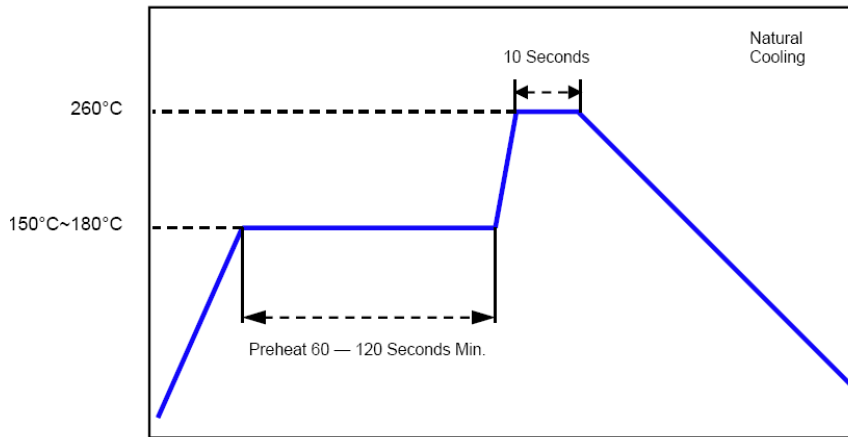

Fig. 3 Recommended reflow soldering profile

1. Recommended reflow methods: IR, hot air oven, nitrogen oven.
2. Recommended maximum paste thickness: 0.25mm (0.010 inch).
3. Devices can be cleaned using standard industry methods and solvents.
4. Soldering temperature and time should not exceed the recommended conditions.

Note: If reflow temperatures exceed the recommended profile, devices may not meet the performance requirements.

Caution: Operation beyond the rated voltage or current may result in rupture electrical arcing or flame.



WARNING:

- Operation beyond the maximum ratings or improper use may result in device damage and possible electrical arcing and flame.
- The devices are intended for protection against occasional over-current or over-temperature fault conditions and should not be used when repeated fault conditions or prolonged trip events are anticipated.
- Contamination of the PPTC material with certain silicon based oils or some aggressive solvents can adversely impact the performance of the devices.
- Device performance can be impacted negatively if devices are handled in a manner inconsistent with recommended electronic, thermal and mechanical procedures for electronic components.
- Operation in circuit with a large inductance can generate a circuit voltage ($L di/dt$) above the rated voltage of the PPTC device.



Стандарт Электрон Связь

Мы молодая и активно развивающаяся компания в области поставок электронных компонентов. Мы поставляем электронные компоненты отечественного и импортного производства напрямую от производителей и с крупнейших складов мира.

Благодаря сотрудничеству с мировыми поставщиками мы осуществляем комплексные и плановые поставки широчайшего спектра электронных компонентов.

Собственная эффективная логистика и склад в обеспечивает надежную поставку продукции в точно указанные сроки по всей России.

Мы осуществляем техническую поддержку нашим клиентам и предпродажную проверку качества продукции. На все поставляемые продукты мы предоставляем гарантию .

Осуществляем поставки продукции под контролем ВП МО РФ на предприятия военно-промышленного комплекса России , а также работаем в рамках 275 ФЗ с открытием отдельных счетов в уполномоченном банке. Система менеджмента качества компании соответствует требованиям ГОСТ ISO 9001.

Минимальные сроки поставки, гибкие цены, неограниченный ассортимент и индивидуальный подход к клиентам являются основой для выстраивания долгосрочного и эффективного сотрудничества с предприятиями радиоэлектронной промышленности, предприятиями ВПК и научно-исследовательскими институтами России.

С нами вы становитесь еще успешнее!

Наши контакты:

Телефон: +7 812 627 14 35

Электронная почта: sales@st-electron.ru

Адрес: 198099, Санкт-Петербург,
Промышленная ул, дом № 19, литера Н,
помещение 100-Н Офис 331