

Optocoupler, Phototriac Output, High dV/dt, Very Low Input Current

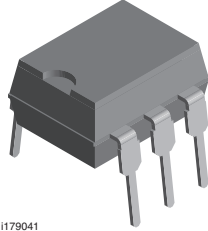

1179041

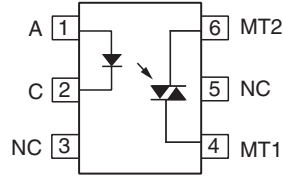

DESCRIPTION

The IL4216/IL4217/IL4218 consists of an AlGaAs IRLED optically coupled to a pair of photosensitive non-zero crossing SCR chips and are connected inversely parallel to form a TRIAC. These three semiconductors are assembled in a six pin 0.3 inch dual in-line package.

High input sensitivity is achieved by using an emitter follower phototransistor and a cascaded SCR predriver resulting in an LED trigger current of less than 1.3 mA (DC).

The IL4216/IL4217/IL4218 uses two discrete SCRs resulting in a commutating dV/dt of greater than 10 kV/μs. The use of a proprietary dV/dt clamp results in a static dV/dt of greater than 10 kV/μs. This clamp circuit has a MOSFET that is enhanced when high dV/dt spikes occur between MT1 and MT2 of the TRIAC. The FET clamps the base of the phototransistor when conducting, disabling the internal SCR predriver.

The blocking voltage of up to 800 V permits control of off-line voltages up to 240 VAC, with a safety factor more than two, and is sufficient for as much as 380 VAC. Current handling capability is up to 300 mA RMS, continuous at 25 °C.

The IL4216/IL4217/IL4218 isolates low-voltage logic from 120, 240, and 380 VAC lines to control resistive inductive, or capacitive loads including motors solenoids, high current thyristors or TRIAC and relays.

FEATURES

- High input sensitivity $I_{FT} = 1.3 \text{ mA}$
- 300 mA on-state current
- High static dV/dt 10000 V/μs, typical
- Inverse parallel SCRs provide commutating dV/dt > 10 kV/μs
- Very Low Leakage < 10 μA
- Isolation test voltage 5300 V_{RMS}
- Lead (Pb)-free component
- Component in accordance to RoHS 2002/95/EC and WEEE 2002/96/EC



RoHS
COMPLIANT

APPLICATIONS

- Solid state relay
- Industrial controls
- Office equipment
- Consumer appliances

AGENCY APPROVALS

- UL1577, file no. E52744 system code J
- CSA 93751
- DIN EN 60747-5-2 (VDE 0884)/DIN EN 60747-5-5 pending available with option 1
- BSI IEC 60950; IEC 60065
- FIMKO

ORDER INFORMATION	
PART	REMARKS
IL4216	600 V V _{DRM} , DIP-6
IL4217	700 V V _{DRM} , DIP-6
IL4218	800 V V _{DRM} , DIP-6
IL4216-X006	600 V V _{DRM} , DIP-6 400 mil (option 6)
IL4216-X009	600 V V _{DRM} , SMD-6 (option 9)
IL4217-X007	700 V V _{DRM} , SMD-6 (option 7)
IL4217-X009	700 V V _{DRM} , SMD-6 (option 9)
IL4218-X006	800 V V _{DRM} , DIP-6 400 mil (option 6)
IL4218-X007	800 V V _{DRM} , SMD-6 (option 7)
IL4218-X009	800 V V _{DRM} , SMD-6 (option 9)

Note

For additional information on the available options refer to option information.

ABSOLUTE MAXIMUM RATINGS (1)					
PARAMETER	TEST CONDITION	PART	SYMBOL	VALUE	UNIT
INPUT					
Reverse voltage			V_R	6.0	V
Forward current			I_F	60	mA
Surge current			I_{FSM}	2.5	A
Power dissipation			P_{diss}	100	mW
Derate linearly from 25 °C				1.33	mW/°C
Thermal resistance			R_{th}	750	°C/W
OUTPUT					
Peak off-state voltage		IL4216	V_{DRM}	600	V
		IL4217	V_{DRM}	700	V
		IL4218	V_{DRM}	800	V
RMS on-state current			I_{DRM}	300	mA
Single cycle surge			I_{TSM}	3.0	A
Power dissipation			P_{diss}	300	mW
Derate linearly from 25 °C				6.6	mW/°C
Thermal resistance			R_{th}	150	°C/W
COUPLER					
Creepage distance				≥ 7.0	mm
Clearance				≥ 7.0	mm
Storage temperature			T_{stg}	- 55 to + 150	°C
Ambient temperature			T_{amb}	- 55 to + 100	°C
Isolation test voltage			V_{ISO}	5300	V_{RMS}
Isolation resistance	$V_{IO} = 500\text{ V}, T_{amb} = 25\text{ °C}$		R_{IO}	≥ 10^{12}	Ω
	$V_{IO} = 500\text{ V}, T_{amb} = 100\text{ °C}$		R_{IO}	≥ 10^{11}	Ω
Lead soldering temperature (2)	5.0 s		T_{slid}	260	°C

Notes

(1) $T_{amb} = 25\text{ °C}$, unless otherwise specified.

Stresses in excess of the absolute maximum ratings can cause permanent damage to the device. Functional operation of the device is not implied at these or any other conditions in excess of those given in the operational sections of this document. Exposure to absolute maximum ratings for extended periods of the time can adversely affect reliability.

(2) Refer to reflow profile for soldering conditions for surface mounted devices (SMD). Refer to wave profile for soldering conditions for through hole devices (DIP).



ELECTRICAL CHARACTERISTICS							
PARAMETER	TEST CONDITION	PART	SYMBOL	MIN.	TYP.	MAX.	UNIT
INPUT							
Forward voltage	$I_F = 20 \text{ mA}$		V_F		1.3	1.5	V
Breakdown voltage	$I_R = 10 \text{ }\mu\text{A}$		V_{BR}	6.0	30		V
Reverse current	$V_R = 6.0 \text{ V}$		I_R		0.1	10	μA
Input capacitance	$V_F = 0 \text{ V}, f = 1.0 \text{ MHz}$		C_{IN}		40		pF
Thermal resistance, junction to lead			R_{thjl}		750		$^{\circ}\text{C/W}$
OUTPUT							
Repetitive peak off-state voltage	$I_{DRM} = 100 \text{ }\mu\text{A}$	IL4216	V_{DRM}	600	650		V
		IL4217	V_{DRM}	700	750		V
		IL4218	V_{DRM}	800	850		V
Off-state voltage	$I_{D(RMS)} = 70 \text{ }\mu\text{A}$	IL4216	$V_{D(RMS)}$	424	460		V
		IL4217	$V_{D(RMS)}$	484	536		V
		IL4218	$V_{D(RMS)}$	565	613		V
Off-state current	$V_D = 600 \text{ V}, T_{amb} = 100 \text{ }^{\circ}\text{C}$		$I_{D(RMS)}$		10	100	μA
Reverse current	$V_R = 600 \text{ V}, T_{amb} = 25 \text{ }^{\circ}\text{C}$		I_{RMS}		10	100	μA
On-state voltage	$I_T = 300 \text{ mA}$		V_{TM}		1.7	3.0	V
On-state current	$PF = 1.0, V_{T(RMS)} = 1.7 \text{ V}$		I_{TM}			300	mA
Surge (non-repetitive, on-state current)	$f = 50 \text{ Hz}$		I_{TSM}			3.0	A
Holding current	$V_T = 3.0 \text{ V}$		I_H		65	200	μA
Latching current	$V_T = 2.2 \text{ V}$		I_L		5.0		mA
LED trigger current	$V_{AK} = 5.0 \text{ V}$		I_{FT}		0.7	1.3	mA
Critical rate of rise of off-state voltage	$V_D = 0.67 V_{DRM}, T_{amb} = 25 \text{ }^{\circ}\text{C}$		dV/dt_{cr}	10000			V/ μs
	$V_D = 0.67 V_{DRM}, T_{amb} = 80 \text{ }^{\circ}\text{C}$		dV/dt_{cr}	5000			V/ μs
Critical rate of rise of voltage at current commutation	$V_D = 0.67 V_{DRM},$ $dI/dt_{crq} \leq 15 \text{ A/ms},$ $T_{amb} = 25 \text{ }^{\circ}\text{C}$		dV/dt_{crq}	10000			V/ μs
	$V_D = 0.67 V_{DRM},$ $dI/dt_{crq} \leq 15 \text{ A/ms},$ $T_{amb} = 80 \text{ }^{\circ}\text{C}$		dV/dt_{crq}	5000			V/ μs
Off-state current	$I_T = 300 \text{ mA}$		dI/dt		100		A/ms
Thermal resistance, junction to lead			R_{thjl}		150		$^{\circ}\text{C/W}$
COUPLER							
Capacitance (input to output)	$f = 1.0 \text{ MHz}, V_{IO} = 0 \text{ V}$		C_{IO}		0.8		pF
Critical rate of rise of coupled input to output voltage	$I_T = 0, V_{RM} = V_{DM} = 300 \text{ VAC}$		$dV_{(IO)}/dt$	5000	1.0		mA

Note

$T_{amb} = 25 \text{ }^{\circ}\text{C}$, unless otherwise specified.

Minimum and maximum values are testing requirements. Typical values are characteristics of the device and are the result of engineering evaluation. Typical values are for information only and are not part of the testing requirements.

POWER FACTOR CONSIDERATIONS

A snubber is not needed to eliminate false operation of the TRIAC driver because of the IL4216/IL4217/IL4218 high static and commutating dV/dt with loads between 1 and 0.8 power factors. When inductive loads with power factors less than 0.8 are being driven, include a RC snubber or a single capacitor directly across the device to damp the peak commutating dV/dt spike. Normally a commutating dV/dt causes a turning-off device to stay on due to the stored energy remaining in the turning-off device.

But in the case of a zero voltage crossing optotriac, the commutating dV/dt spikes can inhibit one half of the TRIAC from turning on. If the spike potential exceeds the inhibit voltage of the zero cross detection circuit, half of the TRIAC will be held-off and not turn-on. This hold-off condition can be eliminated by using a snubber or capacitor placed directly across the optotriac as shown in Figure 1. Note that the value of the capacitor increases as a function of the load current.

The hold-off condition also can be eliminated by providing a higher level of LED drive current. The higher LED drive provides a larger photocurrent which causes the phototransistor to turn-on before the commutating spike has activated the zero cross network. Figure 8 shows the relationship of the LED drive for power factors of less than 1.0. The curve shows that if a device requires 1.5 mA for a resistive load, then 1.8 times (2.7 mA) that amount would be required to control an inductive load whose power factor is less than 0.3.

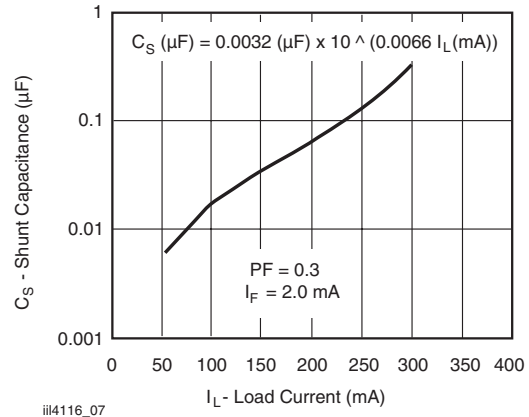

Fig. 3 - Shunt Capacitance vs. Load Current vs. Power Factor

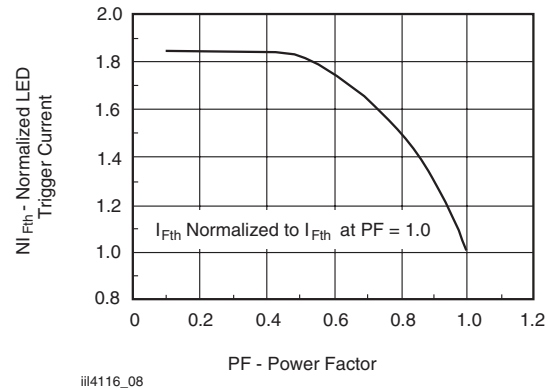

Fig. 4 - Normalized LED Trigger Current

TYPICAL CHARACTERISTICS

T_{amb} = 25 °C, unless otherwise specified

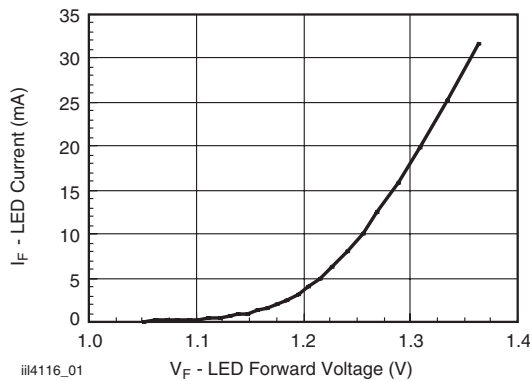

Fig. 5 - LED Forward Current vs. Forward Voltage

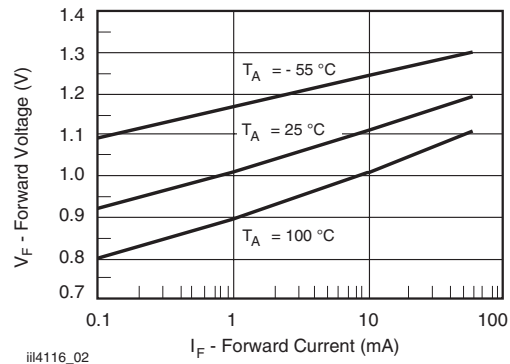
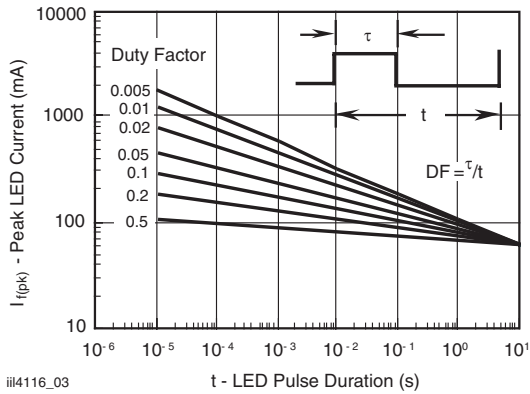
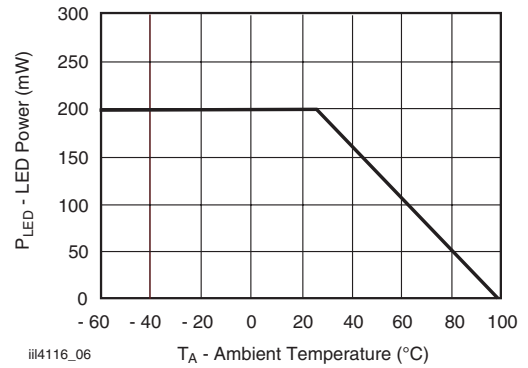

Fig. 6 - Forward Voltage vs. Forward Current



iii4116_03

Fig. 7 - Peak LED Current vs. Duty Factor, τ



iii4116_06

Fig. 10 - Maximum Output Power Dissipation

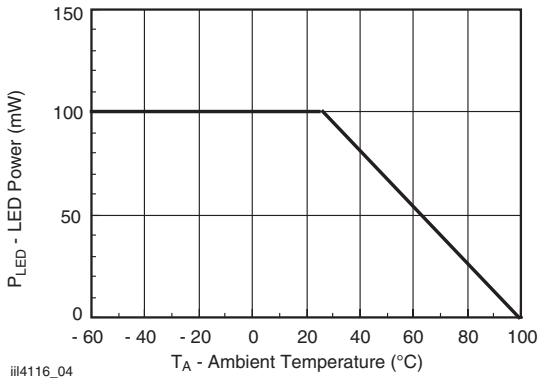

iii4116_04

Fig. 8 - Maximum LED Power Dissipation

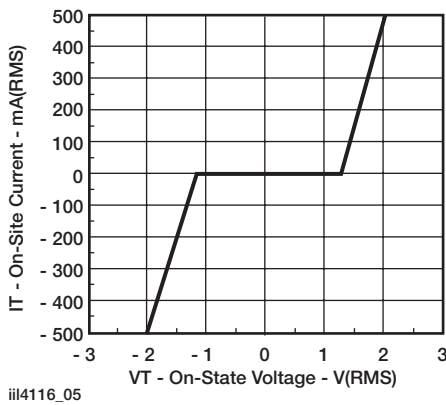

iii4116_05

Fig. 9 - On-State Terminal Voltage vs. Terminal Current

IL4216/IL4217/IL4218



Vishay Semiconductors

Optocoupler, Phototriac Output,
High dV/dt, Very Low Input Current

PACKAGE DIMENSIONS in inches (millimeters)

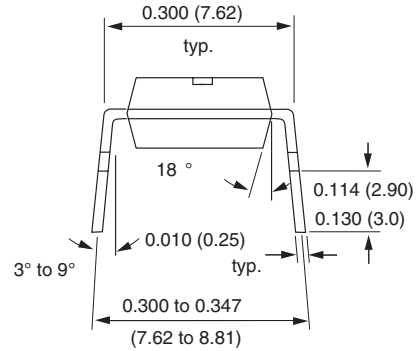
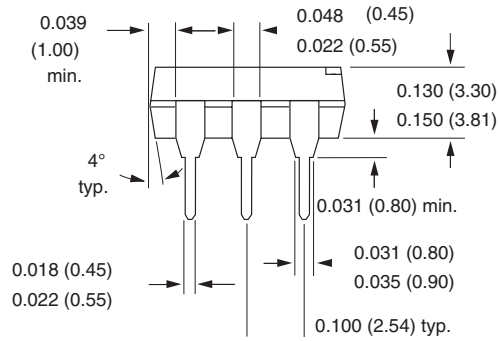
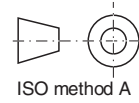
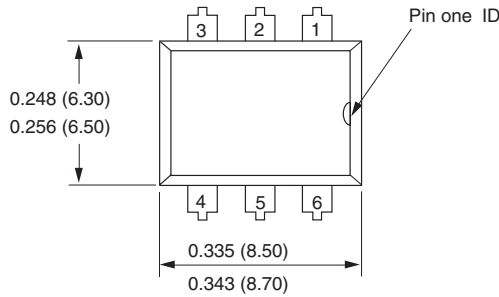

i178004

Option 6

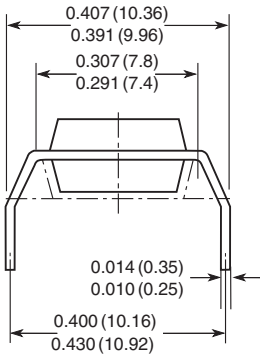

Option 7

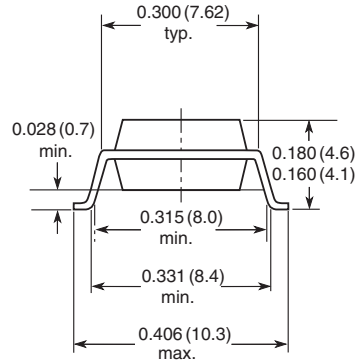

Option 9

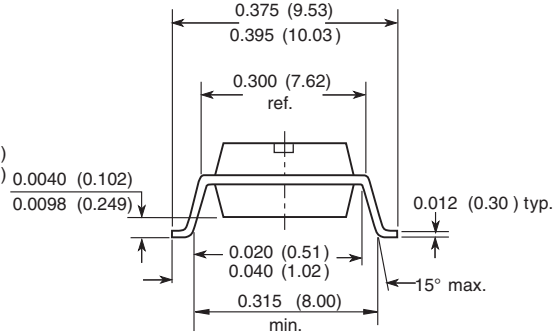

18450

**OZONE DEPLETING SUBSTANCES POLICY STATEMENT**

It is the policy of Vishay Semiconductor GmbH to

1. Meet all present and future national and international statutory requirements.
2. Regularly and continuously improve the performance of our products, processes, distribution and operating systems with respect to their impact on the health and safety of our employees and the public, as well as their impact on the environment.

It is particular concern to control or eliminate releases of those substances into the atmosphere which are known as ozone depleting substances (ODSs).

The Montreal Protocol (1987) and its London Amendments (1990) intend to severely restrict the use of ODSs and forbid their use within the next ten years. Various national and international initiatives are pressing for an earlier ban on these substances.

Vishay Semiconductor GmbH has been able to use its policy of continuous improvements to eliminate the use of ODSs listed in the following documents.

1. Annex A, B and list of transitional substances of the Montreal Protocol and the London Amendments respectively.
2. Class I and II ozone depleting substances in the Clean Air Act Amendments of 1990 by the Environmental Protection Agency (EPA) in the USA.
3. Council Decision 88/540/EEC and 91/690/EEC Annex A, B and C (transitional substances) respectively.

Vishay Semiconductor GmbH can certify that our semiconductors are not manufactured with ozone depleting substances and do not contain such substances.

We reserve the right to make changes to improve technical design
and may do so without further notice.

Parameters can vary in different applications. All operating parameters must be validated for each customer application by the customer. Should the buyer use Vishay Semiconductors products for any unintended or unauthorized application, the buyer shall indemnify Vishay Semiconductors against all claims, costs, damages, and expenses, arising out of, directly or indirectly, any claim of personal damage, injury or death associated with such unintended or unauthorized use.

Vishay Semiconductor GmbH, P.O.B. 3535, D-74025 Heilbronn, Germany



Disclaimer

All product specifications and data are subject to change without notice.

Vishay Intertechnology, Inc., its affiliates, agents, and employees, and all persons acting on its or their behalf (collectively, "Vishay"), disclaim any and all liability for any errors, inaccuracies or incompleteness contained herein or in any other disclosure relating to any product.

Vishay disclaims any and all liability arising out of the use or application of any product described herein or of any information provided herein to the maximum extent permitted by law. The product specifications do not expand or otherwise modify Vishay's terms and conditions of purchase, including but not limited to the warranty expressed therein, which apply to these products.

No license, express or implied, by estoppel or otherwise, to any intellectual property rights is granted by this document or by any conduct of Vishay.

The products shown herein are not designed for use in medical, life-saving, or life-sustaining applications unless otherwise expressly indicated. Customers using or selling Vishay products not expressly indicated for use in such applications do so entirely at their own risk and agree to fully indemnify Vishay for any damages arising or resulting from such use or sale. Please contact authorized Vishay personnel to obtain written terms and conditions regarding products designed for such applications.

Product names and markings noted herein may be trademarks of their respective owners.



**Стандарт
Электрон
Связь**

Мы молодая и активно развивающаяся компания в области поставок электронных компонентов. Мы поставляем электронные компоненты отечественного и импортного производства напрямую от производителей и с крупнейших складов мира.

Благодаря сотрудничеству с мировыми поставщиками мы осуществляем комплексные и плановые поставки широчайшего спектра электронных компонентов.

Собственная эффективная логистика и склад в обеспечивает надежную поставку продукции в точно указанные сроки по всей России.

Мы осуществляем техническую поддержку нашим клиентам и предпродажную проверку качества продукции. На все поставляемые продукты мы предоставляем гарантию .

Осуществляем поставки продукции под контролем ВП МО РФ на предприятия военно-промышленного комплекса России , а также работаем в рамках 275 ФЗ с открытием отдельных счетов в уполномоченном банке. Система менеджмента качества компании соответствует требованиям ГОСТ ISO 9001.

Минимальные сроки поставки, гибкие цены, неограниченный ассортимент и индивидуальный подход к клиентам являются основой для выстраивания долгосрочного и эффективного сотрудничества с предприятиями радиоэлектронной промышленности, предприятиями ВПК и научно-исследовательскими институтами России.

С нами вы становитесь еще успешнее!

Наши контакты:

Телефон: +7 812 627 14 35

Электронная почта: sales@st-electron.ru

Адрес: 198099, Санкт-Петербург,
Промышленная ул, дом № 19, литера Н,
помещение 100-Н Офис 331