

IDC SSL Connector

The IDC SSL connector series are insulation displacement (IDC) SMT and thru-hole wire-to-board connectors designed for quick, tool-less termination of discrete wires onto LED printed circuit boards. These connectors use TE Connectivity (TE) proven insulation displacement technology to provide a robust, stable electrical and mechanical power connection to single or multiple printed circuit boards in solid state lighting and non-lighting applications.

KEY FEATURES

- Available in 1, 2, 3 and 4 positions
- SMT and thru-hole
- Closed end and feed thru
- 18-24 AWG stranded and solid wire
- Dual IDC slots for redundancy
- Wire placement “viewing” window
- Wire gauge color coded
- Tool-less termination

APPLICATIONS

- LED lighting controls
- General illumination LED fixtures
- Connecting strings of pcb LED light modules
- Non-lighting wire-to-board applications



LIGHTING APPLICATIONS



Channel/Sign



Emergency



Digital Signage



Architectural



Street & Stadium



Indoor



Office



Commercial Refrigeration

ELECTRICAL

Operating Current : 8 AMPS (18 AWG only)

Maximum Operating Voltage : 400VAC / 400VDC

Dielectric Withstanding Voltage : 1500VAC

MECHANICAL

Operating Temperature : -40°C to 105°C

Wire Retention : 5 lbs. minimum

MATERIALS

Housings : 94 V0 rated high temperature resistant thermoplastic

Contacts : Tin over nickel plated copper alloy

STANDARDS AND SPECIFICATIONS

UL 1977

Product Specification : 108-2404

Application Specification : 114-13266

Tape and Reel Packaging per EIA-481



PRODUCT DIMENSIONS

Closed End IDC SSL Connectors (SMT)

PART NUMBER	POSITION	WIRE SIZE	DIM "D"	COLOR
2106003-1	1	18 AWG	5.70 [.224]	YELLOW
2106003-2	2	18 AWG	9.70 [.382]	YELLOW
2106003-3	3	18 AWG	13.70 [.539]	YELLOW
2106003-4	4	18 AWG	17.70 [.697]	YELLOW
1-2106003-1	1	20 AWG	5.70 [.224]	BLUE
1-2106003-2	2	20 AWG	9.70 [.382]	BLUE
1-2106003-3	3	20 AWG	13.70 [.539]	BLUE
1-2106003-4	4	20 AWG	17.70 [.697]	BLUE
2-2106003-1	1	22 AWG	5.70 [.224]	GREEN
2-2106003-2	2	22 AWG	9.70 [.382]	GREEN
2-2106003-3	3	22 AWG	13.70 [.539]	GREEN
2-2106003-4	4	22 AWG	17.70 [.697]	GREEN
3-2106003-1	1	24 AWG	5.70 [.224]	RED
3-2106003-2	2	24 AWG	9.70 [.382]	RED
3-2106003-3	3	24 AWG	13.70 [.539]	RED
3-2106003-4	4	24 AWG	17.70 [.697]	RED

Closed End

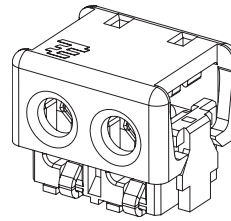

Feed Thru

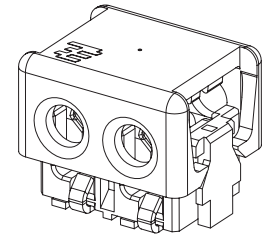

Product Dimensions

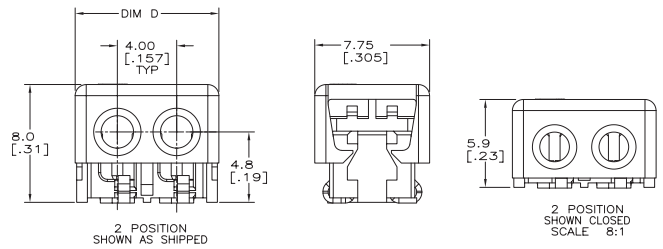

Feed Thru IDC SSL Connectors (SMT)

PART NUMBER	POSITION	WIRE SIZE	DIM "D"	COLOR
2106431-1	1	18 AWG	5.70 [.224]	YELLOW
2106431-2	2	18 AWG	9.70 [.382]	YELLOW
2106431-3	3	18 AWG	13.70 [.539]	YELLOW
2106431-4	4	18 AWG	17.70 [.697]	YELLOW
1-2106431-1	1	20 AWG	5.70 [.224]	BLUE
1-2106431-2	2	20 AWG	9.70 [.382]	BLUE
1-2106431-3	3	20 AWG	13.70 [.539]	BLUE
1-2106431-4	4	20 AWG	17.70 [.697]	BLUE
2-2106431-1	1	22 AWG	5.70 [.224]	GREEN
2-2106431-2	2	22 AWG	9.70 [.382]	GREEN
2-2106431-3	3	22 AWG	13.70 [.539]	GREEN
2-2106431-4	4	22 AWG	17.70 [.697]	GREEN
3-2106431-1	1	24 AWG	5.70 [.224]	RED
3-2106431-2	2	24 AWG	9.70 [.382]	RED
3-2106431-3	3	24 AWG	13.70 [.539]	RED
3-2106431-4	4	24 AWG	17.70 [.697]	RED

Recommended PCB Layout

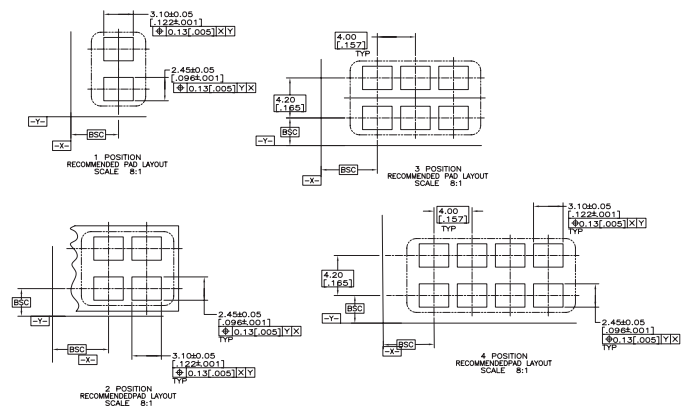

PRODUCT DIMENSIONS cont.

Closed End IDC SSL Connectors (Thru-Hole)

PART NUMBER	POSITION	WIRE SIZE	DIM "D"	COLOR
2106489-1	1	18 AWG	5.70 [.224]	YELLOW
2106489-2	2	18 AWG	9.70 [.382]	YELLOW
2106489-3	3	18 AWG	13.70 [.539]	YELLOW
2106489-4	4	18 AWG	17.70 [.697]	YELLOW
1-2106489-1	1	20 AWG	5.70 [.224]	BLUE
1-2106489-2	2	20 AWG	9.70 [.382]	BLUE
1-2106489-3	3	20 AWG	13.70 [.539]	BLUE
1-2106489-4	4	20 AWG	17.70 [.697]	BLUE
2-2106489-1	1	22 AWG	5.70 [.224]	GREEN
2-2106489-2	2	22 AWG	9.70 [.382]	GREEN
2-2106489-3	3	22 AWG	13.70 [.539]	GREEN
2-2106489-4	4	22 AWG	17.70 [.697]	GREEN
3-2106489-1	1	24 AWG	5.70 [.224]	RED
3-2106489-2	2	24 AWG	9.70 [.382]	RED
3-2106489-3	3	24 AWG	13.70 [.539]	RED
3-2106489-4	4	24 AWG	17.70 [.697]	RED

Closed End

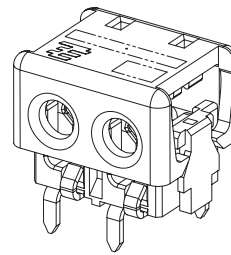

Feed Thru

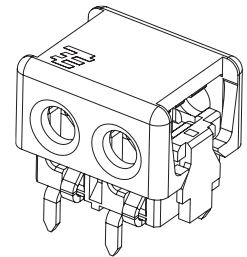

Product Dimensions

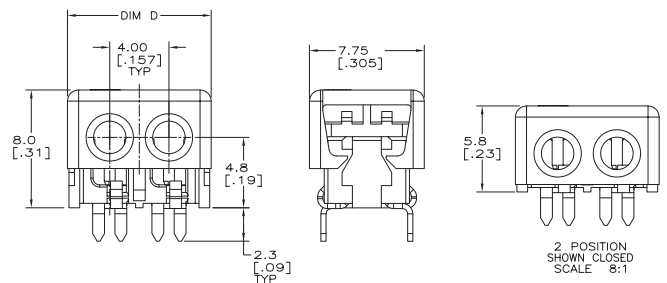

Feed Thru IDC SSL Connectors (Thru-Hole)

PART NUMBER	POSITION	WIRE SIZE	DIM "D"	COLOR
2106751-1	1	18 AWG	5.70 [.224]	YELLOW
2106751-2	2	18 AWG	9.70 [.382]	YELLOW
2106751-3	3	18 AWG	13.70 [.539]	YELLOW
2106751-4	4	18 AWG	17.70 [.697]	YELLOW
1-2106751-1	1	20 AWG	5.70 [.224]	BLUE
1-2106751-2	2	20 AWG	9.70 [.382]	BLUE
1-2106751-3	3	20 AWG	13.70 [.539]	BLUE
1-2106751-4	4	20 AWG	17.70 [.697]	BLUE
2-2106751-1	1	22 AWG	5.70 [.224]	GREEN
2-2106751-2	2	22 AWG	9.70 [.382]	GREEN
2-2106751-3	3	22 AWG	13.70 [.539]	GREEN
2-2106751-4	4	22 AWG	17.70 [.697]	GREEN
3-2106751-1	1	24 AWG	5.70 [.224]	RED
3-2106751-2	2	24 AWG	9.70 [.382]	RED
3-2106751-3	3	24 AWG	13.70 [.539]	RED
3-2106751-4	4	24 AWG	17.70 [.697]	RED

Recommended PCB Layout

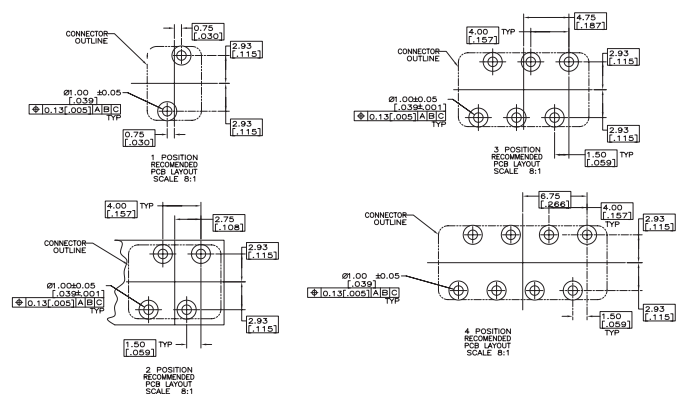

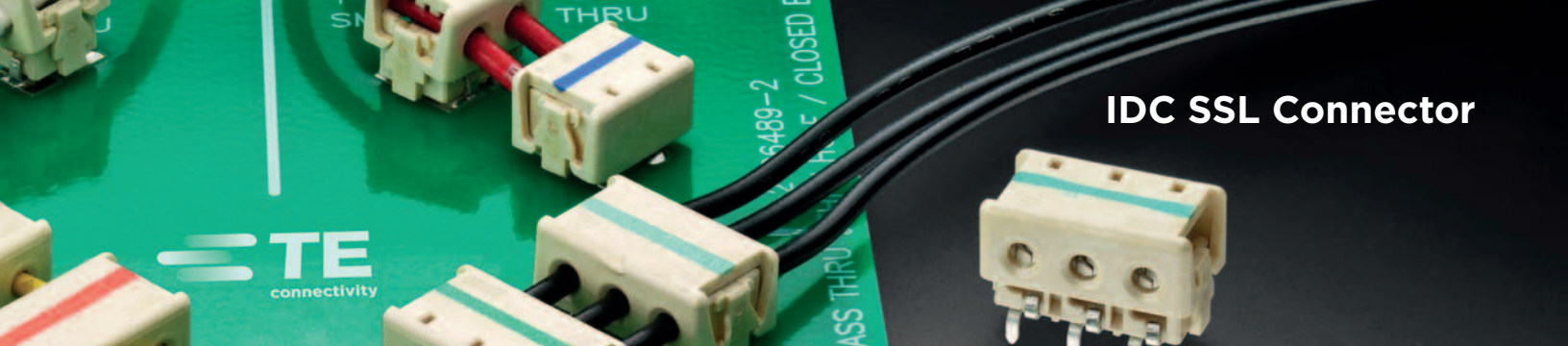

IDC SSL Connector

TERMINATION SEQUENCE

As shipped

(staged configurations)

Insert unstripped wire

(solid or stranded)

Fully inserted wire

(wire retained and visible through "viewing" window)

Tool-less terminated wire

(closed configuration)

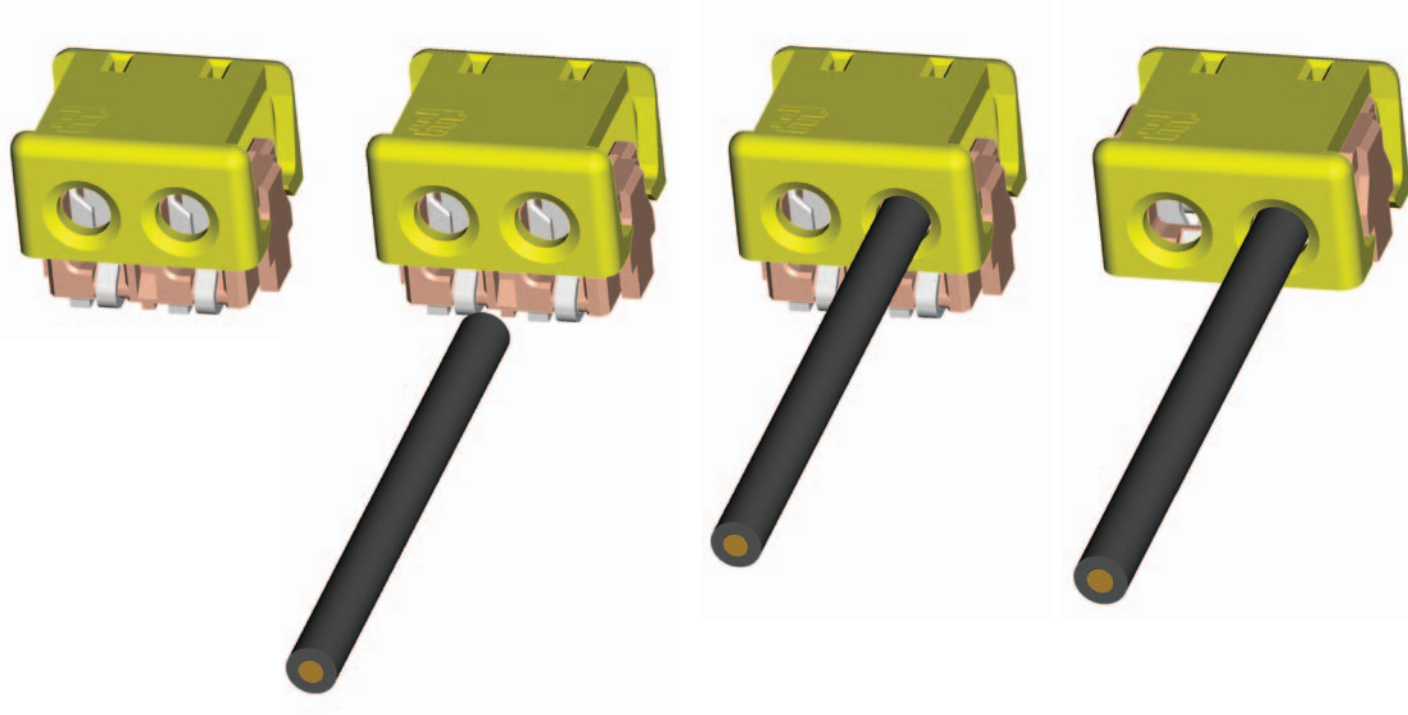

Questions to ask at design in

What wire gauge and insulation type will you be using?

The connectors accept 18-24 AWG stranded and solid wire (separate part numbers per wire size and connector type) with varying maximum insulation outside diameters per wire gauge.

What should be the design criteria for choosing either the closed end or feed thru versions of the connectors?

Closed end connectors should be chosen when attaching power leads to a single printed circuit board. However, in applications that require bringing power to multiple printed circuit boards, feed thru connectors provide a more flexible solution.

Is your manufacturing process automated?

The connectors are manufactured in high temperature plastic material and tape and reel packaged for high speed SMT reflow or thru-hole wave solder processing.

What application tooling options are available?

The pre-assembled connector cover serves two purposes: One, it positions and retains the wire in the pre-stage position. Two, it serves as a wire stuffer for tool-less termination while providing strain relief to the terminated wire. Customers should provide simple "flat rock" tooling to fully seat the cover to complete the termination process.

What mechanical and electrical testing has the connectors been subjected to that validates their long term performance?

The TE Product Specification 108-2404 provides a summary of the test groups, sequences and results that the product was subjected in to during product qualification testing.

What applications dictate the use of either surface mount or thru hole connectors?

The SMT connectors will be used in the majority of the LED applications on aluminum clad printed circuit boards. However, for non-lighting applications that require bringing wire leads to FR4 printed circuit boards mounted with thru hole components, customers will find the thru-hole connectors more advantageous.

What special retention mechanisms are available to help ensure PCB stability?

The Thru-hole connectors have two off-set legs per terminal and the SMT connectors have solder tabs to help ensure printed circuit board stability.

FOR MORE INFORMATION : te.com/lighting

TE Technical Support Center

Internet:	te.com/help
USA:	+1 (800) 522-6752
Canada:	+1 (905) 475-6222
Mexico:	+52 (0) 55-1106-0800
Latin/S. America:	+54 (0) 11-4733-2200
Germany:	+49 (0) 6251-133-1999
UK:	+44 (0) 800-267666
France:	+33 (0) 1-3420-8686
Netherlands:	+31 (0) 73-6246-999
China:	+86 (0) 400-820-6015

Part numbers in this brochure are RoHS Compliant*, unless marked otherwise.

*as defined www.te.com/leadfree

te.com

© 2011 Tyco Electronics Corporation, a TE Connectivity Ltd. Company. All Rights Reserved.

5-1773455-1 CIS WR 10/2011

TE Connectivity and TE connectivity (logo) are trademarks. Other logos, product and/or company names might be trademarks of their respective owners.

While TE has made every reasonable effort to ensure the accuracy of the information in this brochure, TE does not guarantee that it is error-free, nor does TE make any other representation, warranty or guarantee that the information is accurate, correct, reliable or current. TE reserves the right to make any adjustments to the information contained herein at any time without notice. TE expressly disclaims all implied warranties regarding the information contained herein, including, but not limited to, any implied warranties of merchantability or fitness for a particular purpose. The dimensions in this catalog are for reference purposes only and are subject to change without notice. Specifications are subject to change without notice. Consult TE for the latest dimensions and design specifications.





Стандарт Электрон Связь

Мы молодая и активно развивающаяся компания в области поставок электронных компонентов. Мы поставляем электронные компоненты отечественного и импортного производства напрямую от производителей и с крупнейших складов мира.

Благодаря сотрудничеству с мировыми поставщиками мы осуществляем комплексные и плановые поставки широчайшего спектра электронных компонентов.

Собственная эффективная логистика и склад в обеспечивает надежную поставку продукции в точно указанные сроки по всей России.

Мы осуществляем техническую поддержку нашим клиентам и предпродажную проверку качества продукции. На все поставляемые продукты мы предоставляем гарантию .

Осуществляем поставки продукции под контролем ВП МО РФ на предприятия военно-промышленного комплекса России , а также работаем в рамках 275 ФЗ с открытием отдельных счетов в уполномоченном банке. Система менеджмента качества компании соответствует требованиям ГОСТ ISO 9001.

Минимальные сроки поставки, гибкие цены, неограниченный ассортимент и индивидуальный подход к клиентам являются основой для выстраивания долгосрочного и эффективного сотрудничества с предприятиями радиоэлектронной промышленности, предприятиями ВПК и научно-исследовательскими институтами России.

С нами вы становитесь еще успешнее!

Наши контакты:

Телефон: +7 812 627 14 35

Электронная почта: sales@st-electron.ru

Адрес: 198099, Санкт-Петербург,
Промышленная ул, дом № 19, литера Н,
помещение 100-Н Офис 331