

DELPHI SERIES



FEATURES

- High efficiency: 92.5% @ 12Vin, 5V/3A out
- Size:
 - Vertical: 9.4x15.5x6.6 mm (0.37"x0.61"x0.26")
 - Horizontal: 9.4x15.5x7.9mm (0.37"x0.61"x0.31")
- Wide input range: 3.1V~13.8V
- Output voltage programmable from 0.59Vdc to 5.0Vdc via external resistors
- No minimum load required
- Fixed frequency operation
- Input UVLO, output OCP
- Remote ON/OFF (Positive, 5 pin version)
- ISO 9001, TL 9000, ISO 14001, QS9000, OHSAS18001 certified manufacturing facility
- UL/cUL 60950-1 (US & Canada), and TUV (EN60950-1) - pending

Delphi NE Series Non-Isolated Point of Load DC/DC Modules: 3.1~13.8Vin, 0.59V-5.1Vout, 3Aout

The Delphi NE 3A Series, 3.1~13.8V wide input, wide trim single output, non-isolated point of load (POL) DC/DC converters are the latest offering from a world leader in power systems technology and manufacturing — Delta Electronics, Inc. The NE product family is the second generation, non-isolated point-of-load DC/DC power modules which cut the module size by almost 50% in most of the cases compared to the first generation NC series POL modules. The NE 3A product family provides an ultra wide input range to support 3.3V, 5V, 8V, 9.6V, and 12V bus voltage point-of-load applications and it offers up to 3A of output current in a vertically or horizontally mounted through-hole miniature package and the output can be resistor trimmed from 0.59Vdc to 5.0Vdc. It provides a very cost effective, high efficiency, and high density point of load solution. With creative design technology and optimization of component placement, these converters possess outstanding electrical and thermal performance, as well as extremely high reliability under highly stressful operating conditions.

OPTIONS

- Vertical or horizontal versions

APPLICATIONS

- DataCom
- Distributed power architectures
- Servers and workstations
- LAN / WAN applications
- Data processing applications

TECHNICAL SPECIFICATIONS

(Ambient Temperature=25°C, minimum airflow=200LFM, nominal V_{in} =12Vdc unless otherwise specified.)

PARAMETER	NOTES and CONDITIONS	NE12S0A0V/H03			
		Min.	Typ.	Max.	Units
ABSOLUTE MAXIMUM RATINGS					
Input Voltage	Operation	3.0		13.8	Vdc
Operating Temperature (Vertical)	Refer to Fig.34 for the measuring point	-40		123	°C
Operating Temperature (Horizontal)	Refer to Fig.42 for the measuring point	-40		TBD	°C
Storage Temperature		-40		125	°C
Enable Voltage	When V_{in} <5V			3.3	V
	When V_{in} >5V			5.0	V
INPUT CHARACTERISTICS					
Operating Input Voltage		3.0		13.8	V
Input UVLO Turn On Threshold	Total load range turn on		3.0		
Input UVLO Turn Off Threshold	Total load range turn off		2.7		V
Input UVLO Hysteresis			0.3		V
Maximum Input Current	5.0Vout, operating, full load			3.1	A
Off Converter Input Current	Remote OFF, Total input range		15		mA
No-Load Input Current	Total input range		50		mA
Input Reflected-Ripple External Current	Total input range		15	25	mA
Input Voltage Rejection	120Hz		60		dB
Input Voltage Variation	120Hz		1		V/mS
Inrush current	High line input and zero load			1	A ² S
OUTPUT CHARACTERISTICS					
Output Voltage Adjustment Range	See figure30	0.59		5.0	V
Output Voltage Set Point	With a 0.1% trim resistor	-1		+1	%
Output Voltage Load Regulation	$I_o=I_{o_min}$ to I_{o_max}	-0.5		+0.5	%
Output Voltage Line Regulation	$V_{in}=V_{in_min}$ to V_{in_max}	-0.2		+0.2	%
Output Voltage Temperature Regulation	$T_a=0\sim 85^\circ\text{C}$	-0.6		+0.6	%
Total output range	Over load, line, temperature regulation and set point	-3		+3	%
Output Voltage Ripple and Noise	Full load 20MHz bandwidth with 1uF and 10uF ceramic capacitor				
Peak-to-Peak	Total input range , 0.59Vout		10	20	mV
Peak-to-Peak	Total input range , 0.9Vout		15	25	mV
Peak-to-Peak	Total input range , 1.8Vout		20	30	mV
Peak-to-Peak	Total input range , 2.5Vout		25	35	mV
Peak-to-Peak	Total input range , 3.3Vout		30	40	mV
Peak-to-Peak	Total input range , 5.0Vout		40	50	mV
RMS	Full Load, 10uF Tan cap, 12Vin, 5Vo		10	15	mV
Output Current Range		0		3	A
Output Voltage Over-shoot at Start-up	Total input range, Turn ON			0.5	%Vo
Output Voltage Under-shoot at Power-Off	Total input range, Turn OFF			100	mV
Output Current Limitation	Hiccup mode		6		A
DYNAMIC CHARACTERISTICS					
	$C_o=1\mu\text{F}$ ceramic//10uF ceramic capacitor				
Output Dynamic Load Response					
0.59Vout, Step Change In Output Current	Load change between 50%Io and 100%Io, Slew Rate 10A/uS		130		mV
0.59Vout, Setting Time	Deviation decrease to 1%Vout		15		uS
0.9Vout, Step Change In Output Current	Load change between 50%Io and 100%Io, Slew Rate 10A/uS		150		mV
0.9Vout, Setting Time	Deviation decrease to 1%Vout		15		uS
2.5Vout, Step Change In Output Current	Load change between 50%Io and 100%Io, Slew Rate 10A/uS		175		mV
2.5Vout, Setting Time	Deviation decrease to 1%Vout		15		uS
5Vout, Step Change In Output Current	Load change between 50%Io and 100%Io, Slew Rate 10A/uS		230		mV
5Vout, Setting Time	Deviation decrease to 1%Vout		15		uS
Turn On Transient					
Turn On Delay by Enable	From Enable high to 90% of Vo		2	3	ms
Turn on Delay by Vin	From $V_{in}=UVLO_ON$ to 90% of Vo		2	3	ms
Turn on Rise time			1.5	2	ms
0.9Vout, Maximum Output Capacitor	turn on overshoot <1% vo ,ESR ≥ 1mΩ			1500	μF
2.5Vout, Maximum Output Capacitor	turn on overshoot <1% vo ,ESR ≥ 1mΩ			1000	μF
5.0Vout, Maximum Output Capacitor	turn on overshoot <1% vo ,ESR ≥ 1mΩ			500	uF
Minimum Output Capacitive Load		0			μF
EFFICIENCY					
0.59Vout	$V_{in}=3.3V, I_o=3A$		65.5		%
0.59Vout	$V_{in}=12V, I_o=3A$		65		%
0.9Vout	$V_{in}=3.3V, I_o=3A$		74.5		%
0.9Vout	$V_{in}=12V, I_o=3A$		73.5		%
1.8Vout	$V_{in}=3.3V, I_o=3A$		85.5		%
1.8Vout	$V_{in}=12V, I_o=3A$		83.5		%
2.5Vout	$V_{in}=3.3V, I_o=3A$		89.5		%
2.5Vout	$V_{in}=12V, I_o=3A$		86		%
5.0Vout	$V_{in}=12V, I_o=3A$		92.5		%
5.0Vout	$V_{in}=12V, I_o=3A$, sink efficiency		91		%
FEATURE CHARACTERISTICS					
Switching Frequency	Fixed		500		KHz
High Level Input Voltage	Module On (or leave the pin open)	1.0		5.5	V
Low Level Input Voltage	Module Off	-0.3		0.4	V
GENERAL SPECIFICATIONS					
Calculated MTBF	$T_a=25^\circ\text{C}$, 200LFM, 80% load		TBD		Mhours
Weight			1.4		grams



ELECTRICAL CHARACTERISTICS CURVE

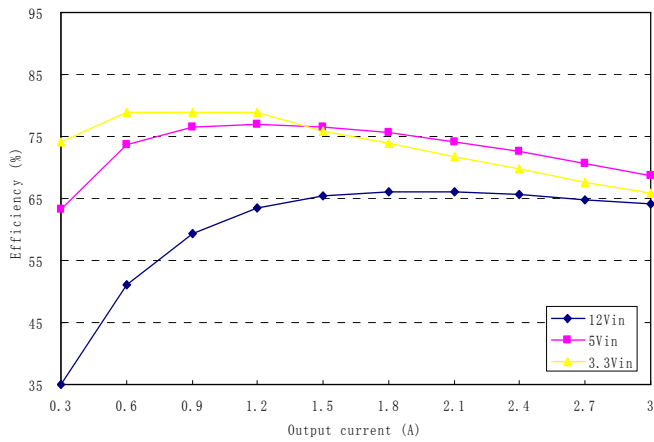

Figure 1: Converter efficiency vs. output current (0.59V output voltage, 3.3V/5V/12V input voltage)

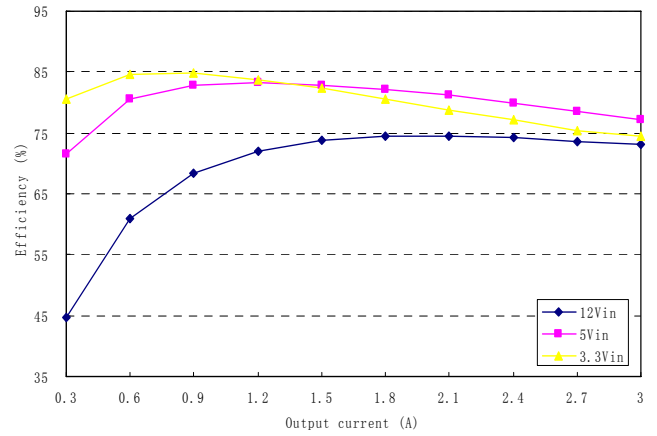

Figure 2: Converter efficiency vs. output current (0.9V output voltage, 3.3V/5V/12V input voltage)

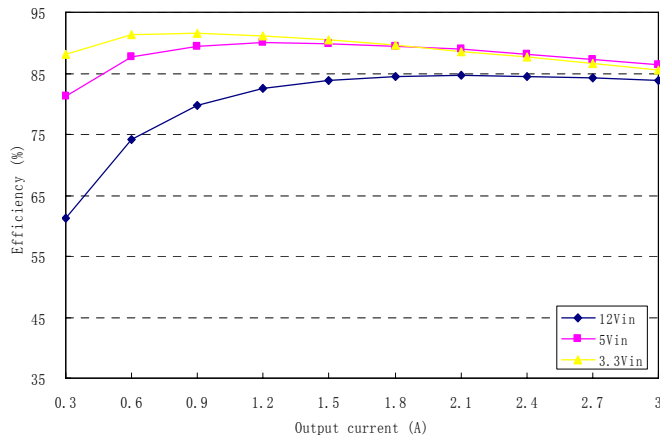

Figure 3: Converter efficiency vs. output current (1.8V output voltage, 3.3V/5V/12V input voltage)

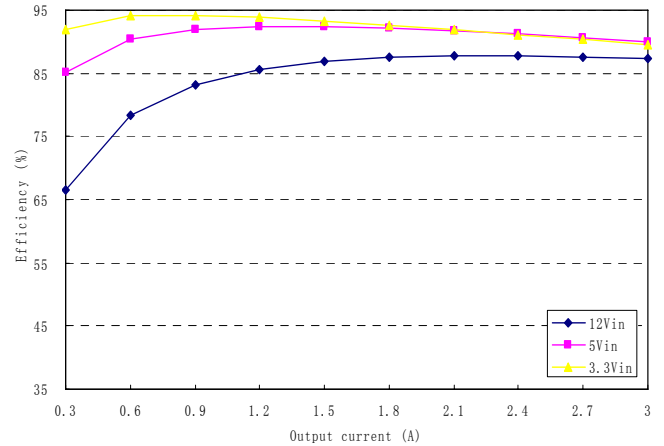

Figure 4: Converter efficiency vs. output current (2.5V output voltage, 3.3V/5V/12V input voltage)

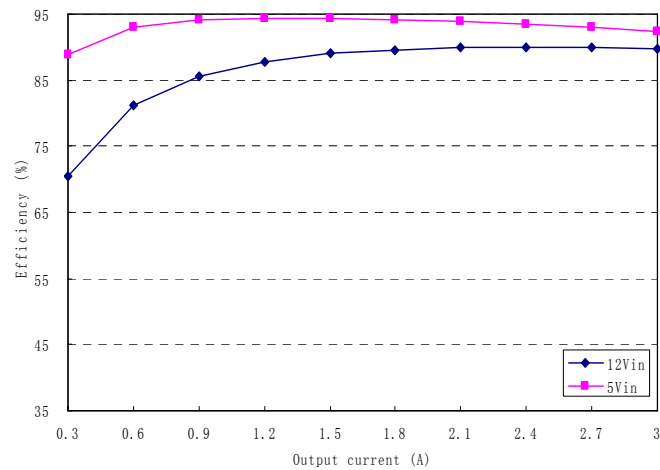

Figure 5: Converter efficiency vs. output current (3.3V output voltage, 5V/12V input voltage)

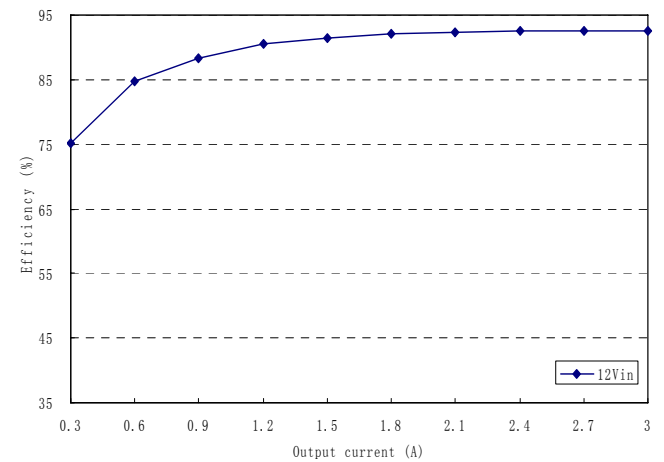

Figure 6: Converter efficiency vs. output current (5.0V output voltage, 12V input voltage)



ELECTRICAL CHARACTERISTICS CURVES (CON.)

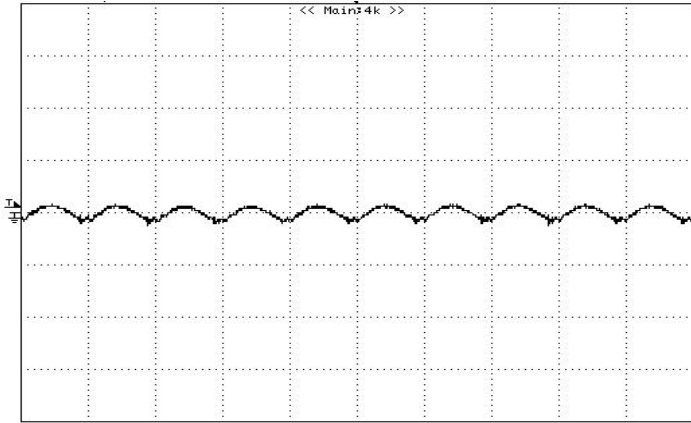

Figure 7: Output ripple & noise at 12Vin, 0.59V/3A out
(20mV/div, 2uS/div)

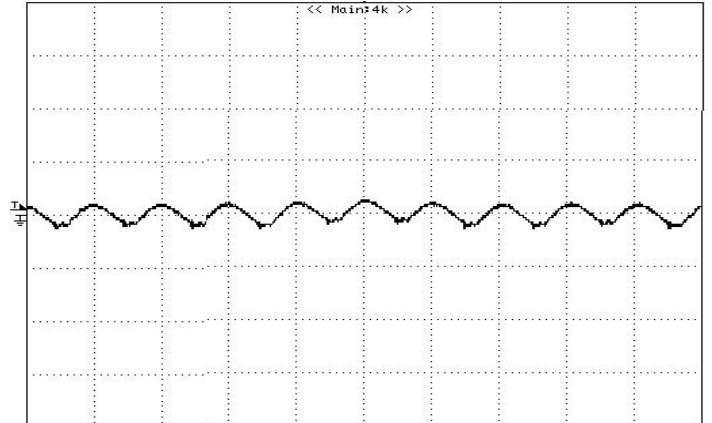

Figure 8: Output ripple & noise at 12Vin, 0.9V/3A out
(20mV/div, 2uS/div)

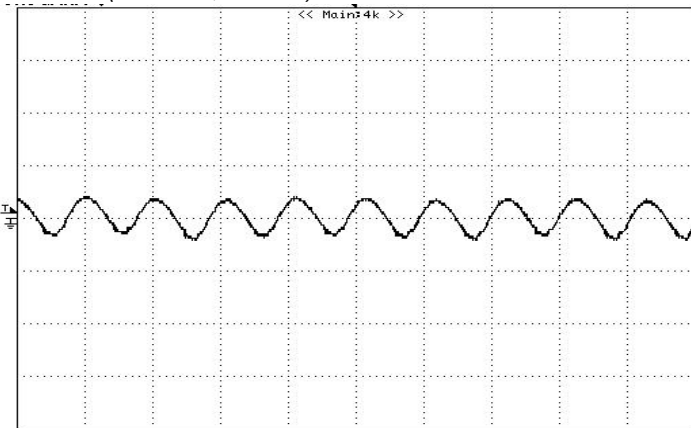

Figure 9: Output ripple & noise at 12Vin, 1.8V/3A out
(20mV/div, 2uS/div)

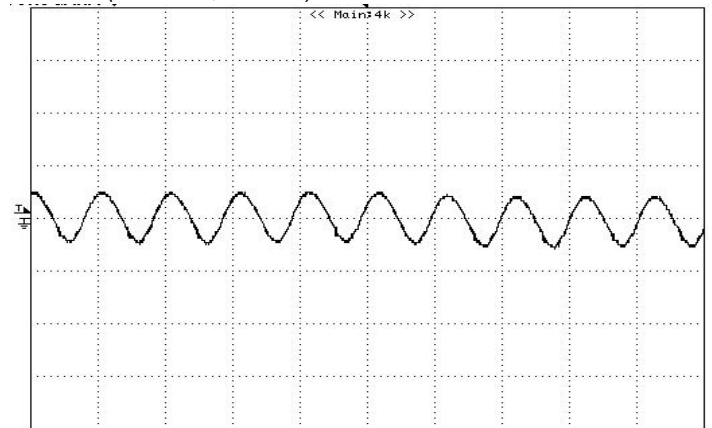

Figure 10: Output ripple & noise at 12Vin, 2.5V/3A out
(20mV/div, 2uS/div)

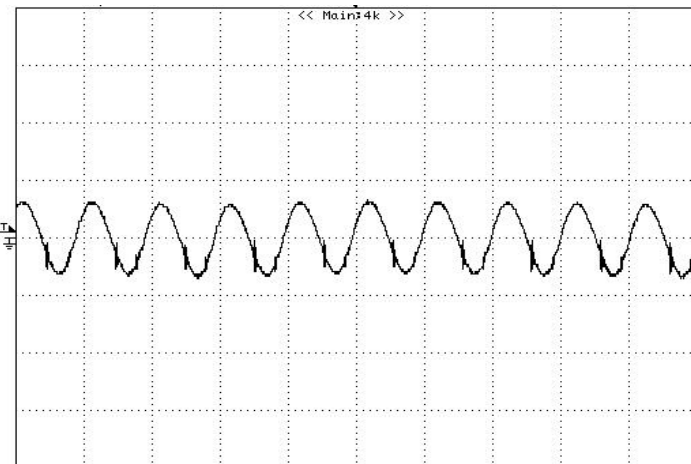

Figure 11: Output ripple & noise at 12Vin, 3.3V/3A out
(20mV/div, 2uS/div)

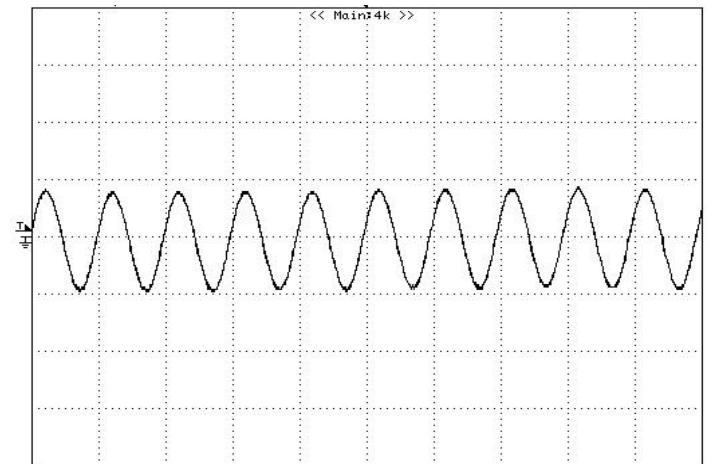

Figure 12: Output ripple & noise at 12Vin, 5.0V/3A out
(20mV/div, 2uS/div)

ELECTRICAL CHARACTERISTICS CURVES (CON.)

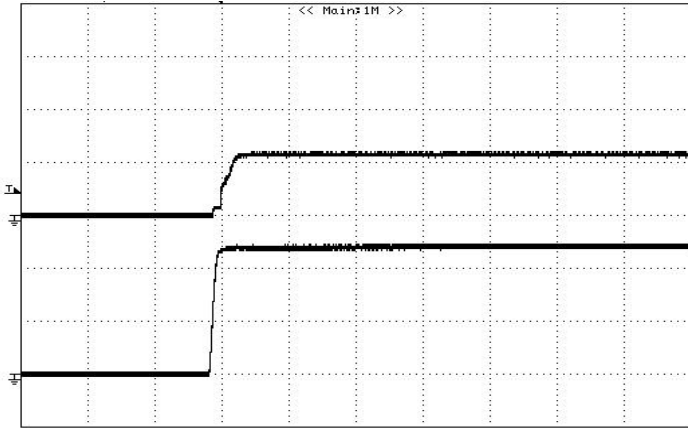

Figure 13: Turn on delay time at 12Vin, 0.59V/3A out
Ch1: Vin(5V/div) Ch4: Vout(0.5V/div) 5mS/div

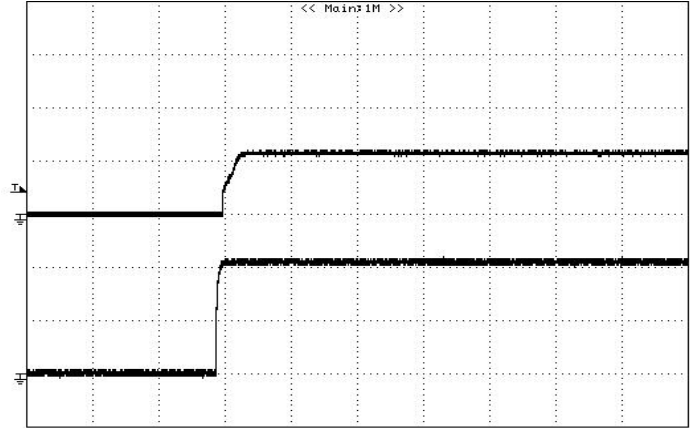

Figure 14: Turn on delay time Remote On/Off, 0.59V/3A out
Ch1: Enable(1V/div) Ch4: Vout(0.5V/div) 5mS/div

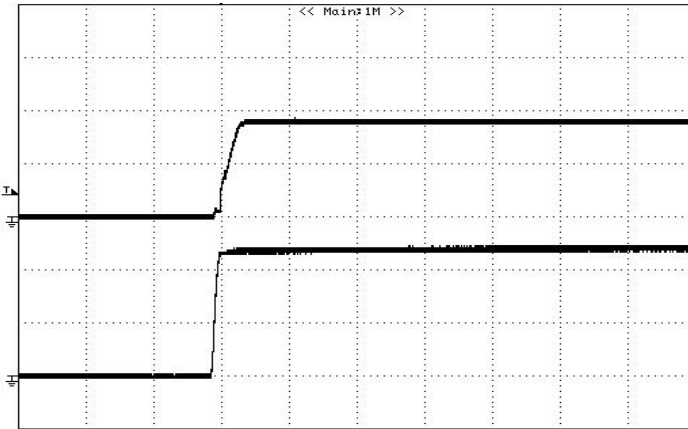

Figure 15: Turn on delay time at 12Vin, 0.9V/3A out
Ch1: Vin(5V/div) Ch4: Vout(0.5V/div) 5mS/div

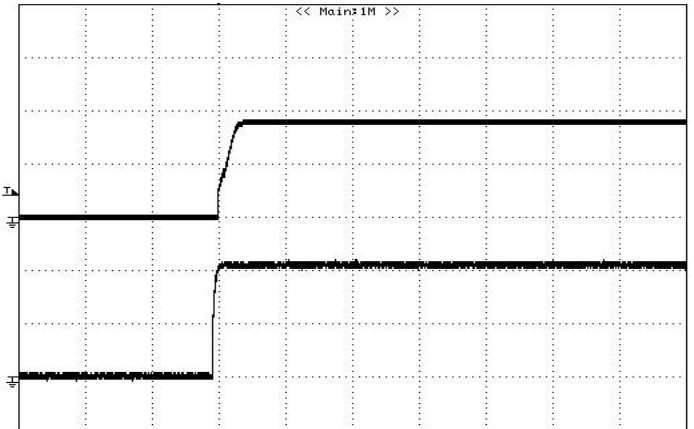

Figure 16: Turn on delay time at Remote On/Off, 0.9V/3A out
Ch1: Enable(1V/div) Ch4: Vout(0.5V/div) 5mS/div

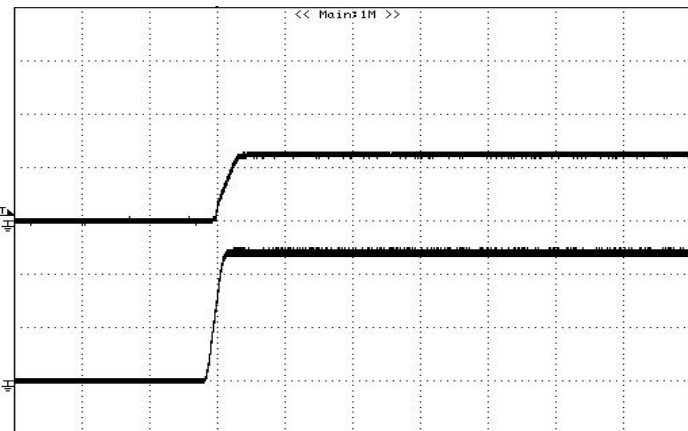

Figure 17: Turn on delay time at 12Vin, 2.5V/3A out
Ch1: Vin(5V/div) Ch4: Vout(2V/div) 5mS/div

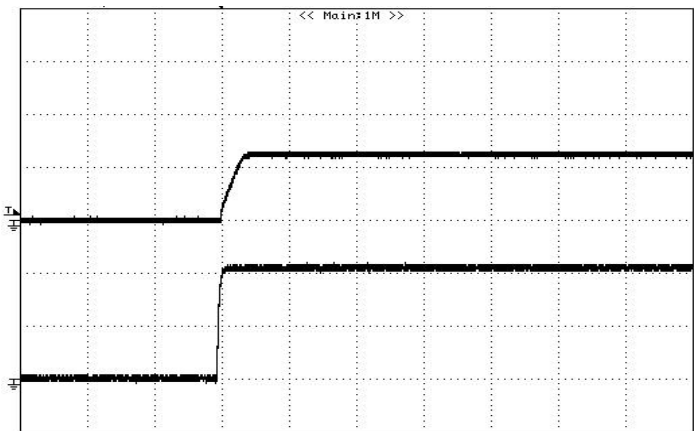

Figure 18: Turn on delay time at Remote On/Off, 2.5V/3A out
Ch1: Enable(1V/div) Ch4: Vout(2V/div) 5mS/div

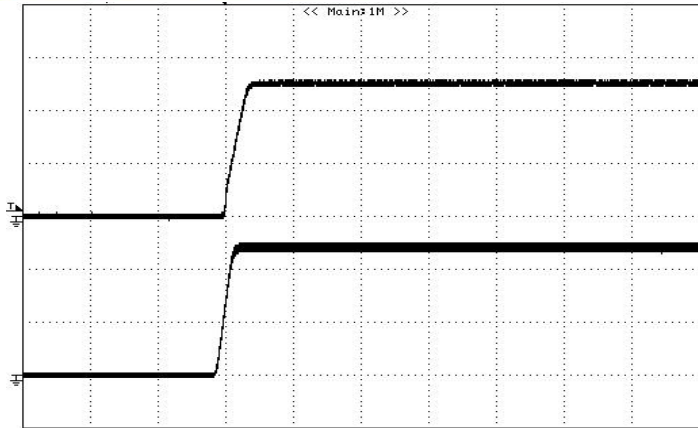

Figure 19: Turn on delay time at 12Vin, 5V/3A out
Ch1: Vin(5V/div) Ch4: Vout(2V/div) 5mS/div

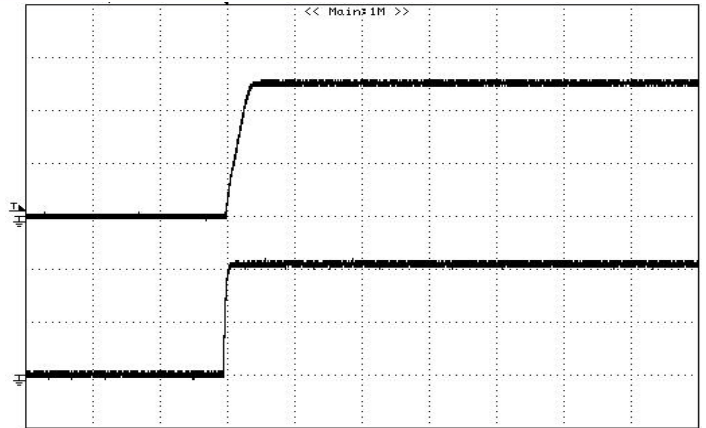

Figure 20: Turn on delay time at Remote On/Off, 5V/3A out
Ch1: Enable(1V/div) Ch4: Vout(2V/div) 5mS/div



Figure 21: Typical transient response to step load change at 10A/μS between 50% and 100% load, at 12Vin, 0.59V out; CH2: VOUT(0.1V/div), CH4: Iout (0.5A/div), 100uS/div

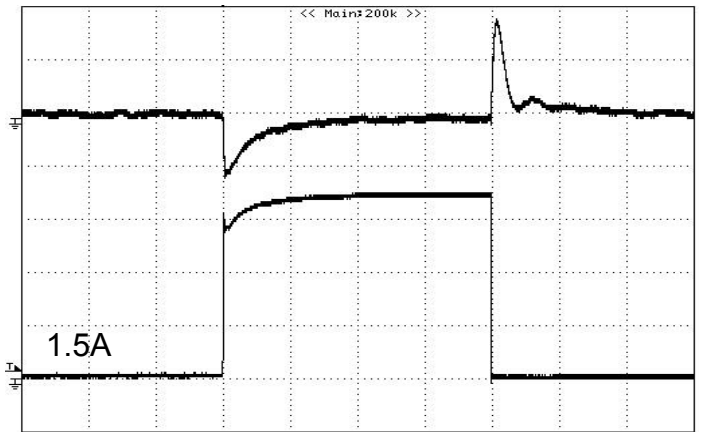

Figure 22: Typical transient response to step load change at 10A/μS between 50% to 100% load, at 12Vin, 0.9V out
CH2: VOUT(0.1V/div), CH4: Iout (0.5A/div), 100uS/div

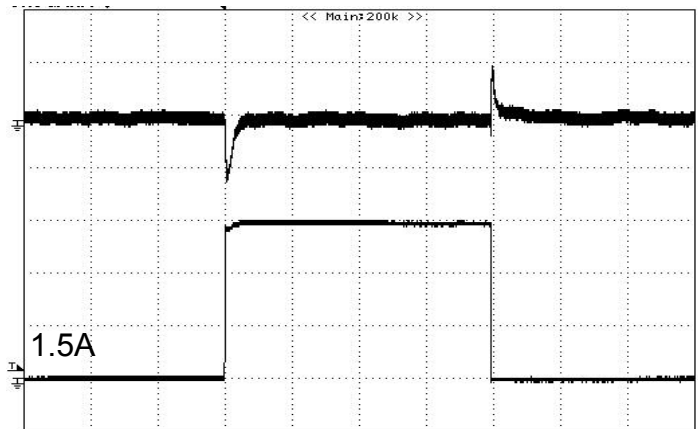

Figure 23: Typical transient response to step load change at 10A/μS between 50% to 100% load, at 12Vin, 2.5V out
CH2: VOUT(0.1V/div), CH4: Iout (0.5A/div), 100uS/div

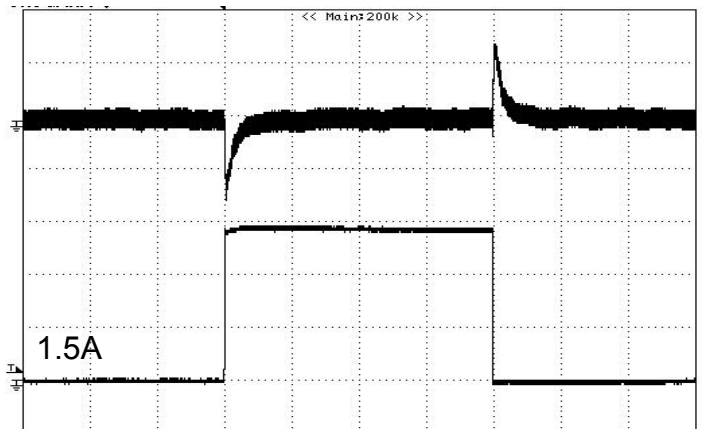

Figure 24: Typical transient response to step load change at 10A/μS between 50% to 100% load, at 12Vin, 5.0V out
CH2: VOUT(0.1V/div), CH4: Iout (0.5A/div), 100uS/div

DESIGN CONSIDERATIONS

The NE12S0A0V(H)03 uses a single phase and voltage mode controlled buck topology. The output can be trimmed from 0.59Vdc to 5.0Vdc by a resistor from Trim pin to Ground.

The converter can be turned ON/OFF by remote control with positive on/off (ENABLE pin) logic. The converter DC output is disabled when the signal is driven low (below 0.4V). This pin is also used as the input turn on threshold judgment. Its voltage is percent of Input voltage during floating due to internal connection. So we do not suggest using an active high signal (higher than 1.0V) to turn on the module because this high level voltage will disable UVLO function. The module will turn on when this pin is floating and the input voltage is higher than the threshold.

The converter can protect itself by entering hiccup mode against over current and short circuit condition. Also, the converter will shut down when an over voltage protection is detected.

Safety Considerations

It is recommended that the user to provide a very fast-acting type fuse in the input line for safety. The output voltage set-point and the output current in the application could define the amperage rating of the fuse.

FEATURES DESCRIPTIONS

Enable (On/Off)

The ENABLE (on/off) input allows external circuitry to put the NE converter into a low power dissipation (sleep) mode. Positive ENABLE is available as standard. With the active high function, the output is guaranteed to turn on if the ENABLE pin is driven above 1.0V. The output will turn off if the ENABLE pin voltage is pulled below 0.4V.

Undervoltage Lockout

The ENABLE pin is also used as input UVLO function. Leaving the enable floating, the module will turn on if the input voltage is higher than the turn-on threshold and turn off if the input voltage is lower than the turn-off threshold. The default turn-on voltage is 3.0V with 300mV hysteresis.

The turn-on voltage may be adjusted with a resistor placed between the "Enable" pin and "Ground" pin. The equation for calculating the value of this resistor is:

$$V_{EN_RTH} = \frac{15.05 \times (R + 6.46)}{6.46 \times R} + 0.5$$

$$V_{EN_FTH} = V_{EN_RTH} - 0.3V$$

V_{EN_FTH} is the turn-off threshold

V_{EN_RTH} is the turn-on threshold

R (Kohm) is the outen resistor connected from Enable pin to the GND

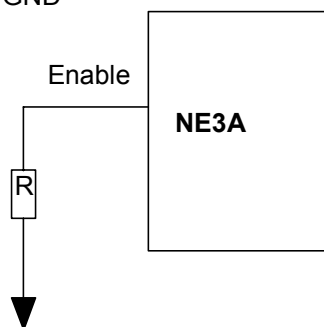

Fig. 25. UVLO setting

An active high voltage will disable the input UVLO function.

FEATURES DESCRIPTIONS (CON.)

The ENABLE input can be driven in a variety of ways as shown in Figures 26 and 27. If the ENABLE signal comes from the primary side of the circuit, the ENABLE can be driven through either a bipolar signal transistor (Figure 26). If the enable signal comes from the secondary side, then an opto-coupler or other isolation devices must be used to bring the signal across the voltage isolation (please see Figure 27).

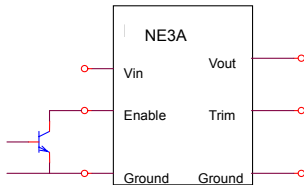

Figure 26: Enable Input drive circuit for NE series

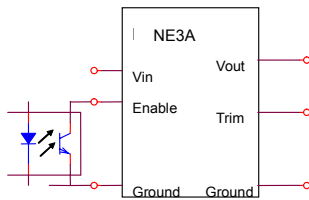

Figure 27: Enable input drive circuit example with isolation.

Input Under-Voltage Lockout

The input under-voltage lockout prevents the converter from being damaged while operating when the input voltage is too low. The lockout occurs between 2.7V to 3.0V.

Over-Current and Short-Circuit Protection

The NE series modules have non-latching over-current and short-circuit protection circuitry. When over current condition occurs, the module goes into the non-latching hiccup mode. When the over-current condition is removed, the module will resume normal operation.

An over current condition is detected by measuring the voltage drop across the MOSFETs. The voltage drop across the MOSFET is also a function of the MOSFET's $R_{ds(on)}$. $R_{ds(on)}$ is affected by temperature, therefore ambient temperature will affect the current limit inception point.

The detection of the $R_{ds(on)}$ of MOSFETs also acts as an over temperature protection since high temperature will cause the $R_{ds(on)}$ of the MOSFETs to increase, eventually triggering over-current protection.

Output Voltage Programming

The output voltage of the NE series is trimmable by connecting an external resistor between the trim pin and output ground as shown Figure 28 and the typical trim resistor values are shown in Figure 29

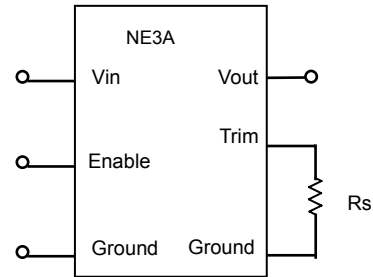

Figure 28: Trimming Output Voltage

The NE03 module has a trim range of 0.59V to 5.0V. The trim resistor equation for the NE03A is :

$$R_s(\Omega) = \frac{1182}{V_{out} - 0.591}$$

V_{out} is the output voltage setpoint

R_s is the resistance between Trim and Ground

R_s values should not be less than 268 Ω

Output Voltage	R_s (Ω)
0.59V	open
+0.9 V	3.82k
+1.8 V	978
+2.5 V	619
+3.3 V	436
+5.0V	268

Figure 29: Typical trim resistor values

The relationship between input voltage and output voltage shown as Figure 30

$V_{out} \backslash V_{in}$	0.59V	0.9V	1.8V	2.5V	3.3V	5.0V
3.3V	Y	Y	Y	Y	N	N
5.0V	Y	Y	Y	Y	Y	N
8.0V	Y	Y	Y	Y	Y	Y
12V	Y	Y	Y	Y	Y	Y

Figure 30: Relationship between V_{in} VS V_{out}

FEATURES DESCRIPTIONS (CON.)

Voltage Margining Adjustment

Output voltage margin adjusting can be implemented in the NE modules by connecting a resistor, $R_{\text{margin-up}}$, from the Trim pin to the Ground for margining up the output voltage. Also, the output voltage can be adjusted lower by connecting a resistor, $R_{\text{margin-down}}$, from the Trim pin to the voltage source V_t . Figure 31 shows the circuit configuration for output voltage margining adjustment.

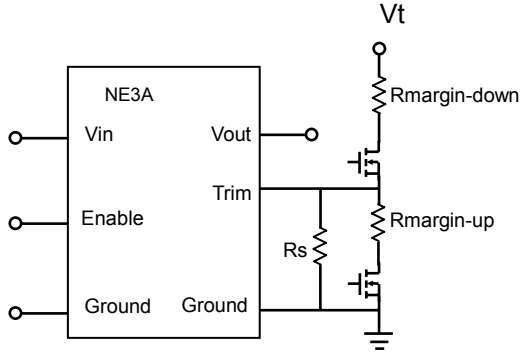

Figure 31: Circuit configuration for output voltage margining

Paralleling

NE03 converters do not have built-in current sharing (paralleling) ability. Hence, paralleling of multiple NE03 converters is not recommended.

Output Capacitance

There is internal output capacitor on the NE series modules. Hence, no external output capacitor is required for stable operation.

Reflected Ripple Current and Output Ripple and Noise Measurement

The measurement set-up outlined in Figure 32 has been used for both input reflected/ terminal ripple current and output voltage ripple and noise measurements on NE series converters.

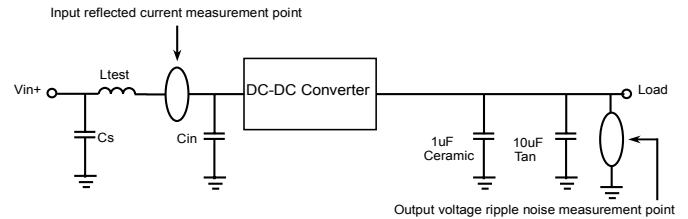

$C_s=270\mu\text{F}^*1$, $L_{\text{test}}=2\mu\text{H}$, $C_{\text{in}}=270\mu\text{F}^*1$

Figure 32: Input reflected ripple/ capacitor ripple current and output voltage ripple and noise measurement setup for NE03



THERMAL CONSIDERATION

Thermal management is an important part of the system design. To ensure proper, reliable operation, sufficient cooling of the power module is needed over the entire temperature range of the module. Convection cooling is usually the dominant mode of heat transfer.

Hence, the choice of equipment to characterize the thermal performance of the power module is a wind tunnel.

Thermal Testing Setup

Delta's DC/DC power modules are characterized in heated vertical wind tunnels that simulate the thermal environments encountered in most electronics equipment. This type of equipment commonly uses vertically mounted circuit cards in cabinet racks in which the power modules are mounted.

The following figure shows the wind tunnel characterization setup. The power module is mounted on a test PWB and is vertically positioned within the wind tunnel. The space between the neighboring PWB and the top of the power module is constantly kept at 6.35mm (0.25").

Thermal Derating

Heat can be removed by increasing airflow over the module. To enhance system reliability, the power module should always be operated below the maximum operating temperature. If the temperature exceeds the maximum module temperature, reliability of the unit may be affected.

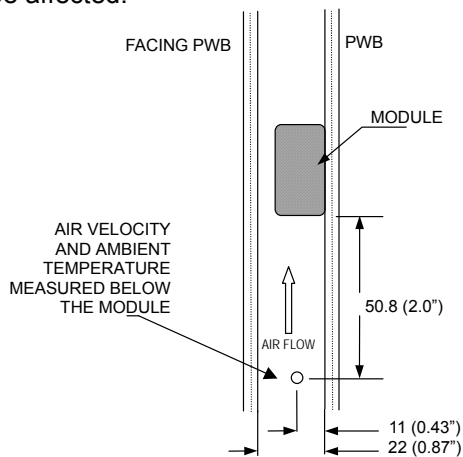

Note: Wind tunnel test setup figure dimensions are in millimeters and (Inches)

Figure 33: Wind tunnel test setup

DS_NE12S03A_10032008

THERMAL CURVES (VERTICAL)

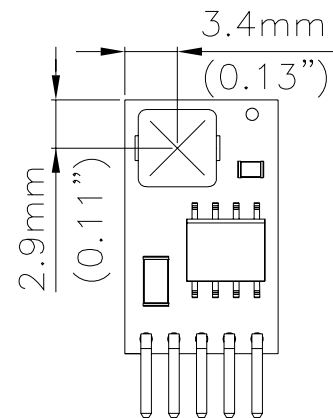

Figure 34: Temperature measurement location* The allowed maximum hot spot temperature is defined at 123 °C

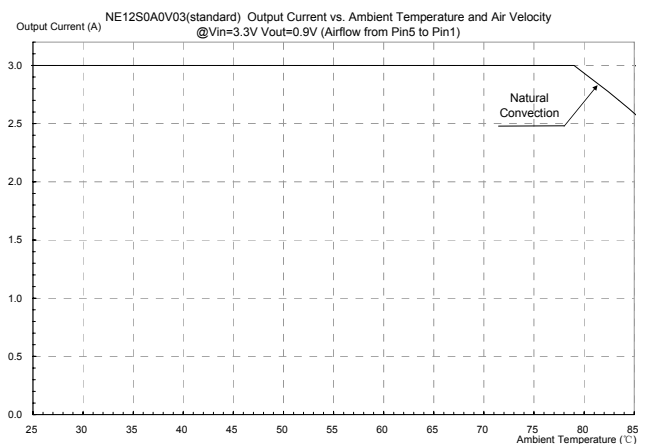

Figure 35: Output current vs. ambient temperature and air velocity @Vin=3.3V, Vout=0.9V (Airflow from Pin5 to Pin1)

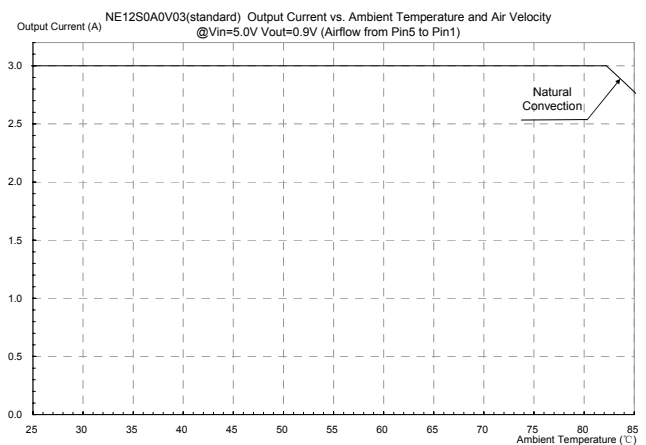

Figure 36: Output current vs. ambient temperature and air velocity @Vin=5.0V, Vout=0.9V (Airflow from Pin5 to Pin1)

THERMAL CURVES (VERTICAL)

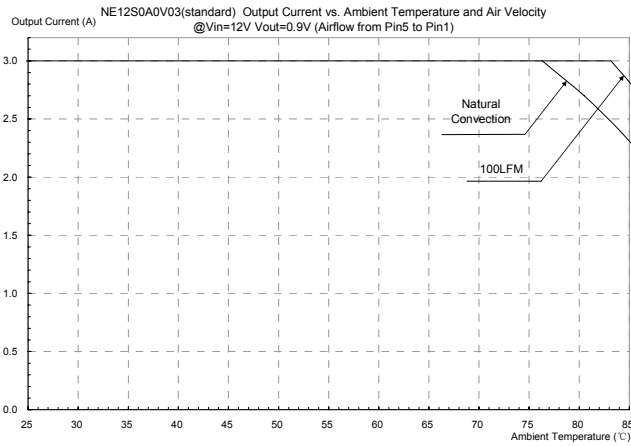

Figure 37: Output current vs. ambient temperature and air velocity @ $V_{in}=12V$, $V_{out}=0.9V$ (Airflow from Pin5 to Pin1)

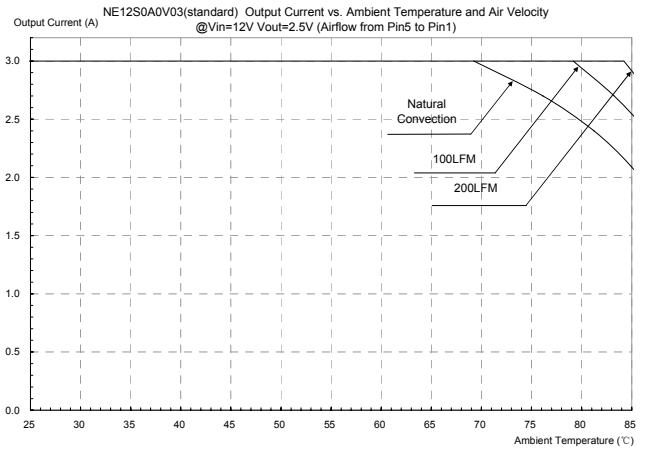

Figure 40: Output current vs. ambient temperature and air velocity @ $V_{in}=12V$, $V_{out}=2.5V$ (Airflow from Pin5 to Pin1)

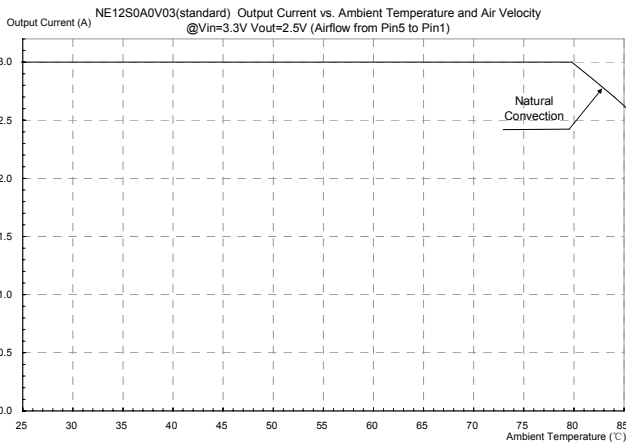

Figure 38: Output current vs. ambient temperature and air velocity @ $V_{in}=3.3V$, $V_{out}=2.5V$ (Airflow from Pin5 to Pin1)

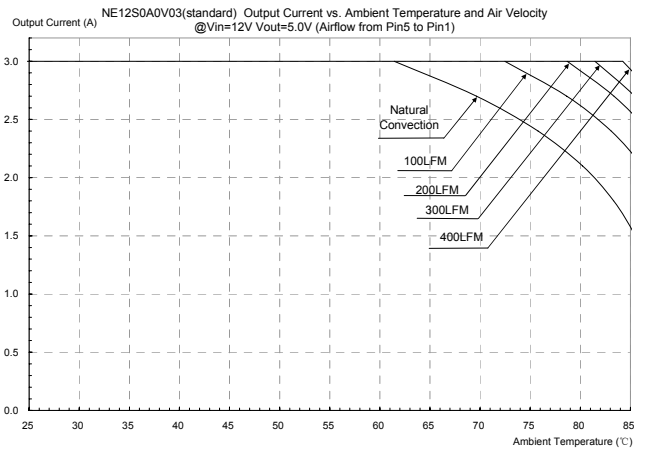

Figure 41: Output current vs. ambient temperature and air velocity @ $V_{in}=12V$, $V_{out}=5.0V$ (Airflow from Pin5 to Pin1)

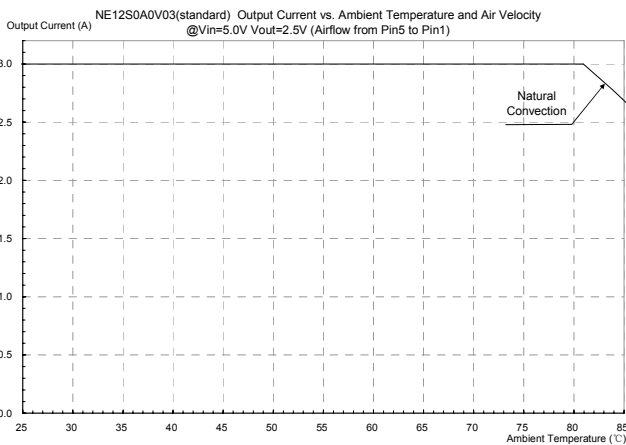
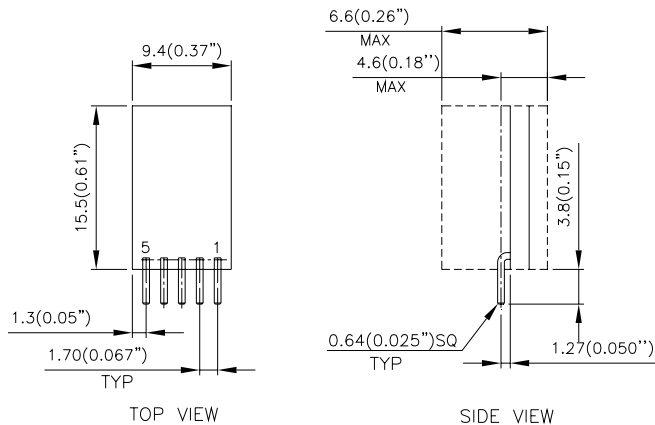

Figure 39: Output current vs. ambient temperature and air velocity @ $V_{in}=5V$, $V_{out}=2.5V$ (Airflow from Pin5 to Pin1)



MECHANICAL DRAWING

VERTICAL



HORIZONTAL

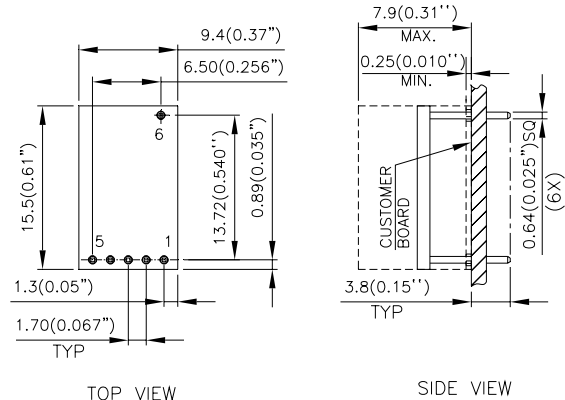

PIN ASSIGNMENT

PIN#	FUNCTION
1	Enable
2	Vin
3	Common/RTN
4	Vout
5	PG/Trim

PIN ASSIGNMENT

PIN#	FUNCTION
1	Enable
2	Vin
3	Common/RTN
4	Vout
5	PG/Trim
6	Mech. Support

NOTES:

DIMENSIONS ARE IN MILLIMETERS AND (INCHS)

TOLERANCE: X.X mm±0.5 mm(X.XX in.±0.02 in.)

X.XX mm±0.25 mm(X.XXX in.±0.010 in.)

PART NUMBERING SYSTEM

NE	12	S	0A0	V	03	P	N	F	A
Product Series	Input Voltage	Number of outputs	Output Voltage	Mounting	Output Current	ON/OFF Logic	Pin Length		Option Code
NE-Non-isolated Series	12- 3.1~13.8V	S- Single Output	0A0 - programmable	H - Horizontal V - Vertical	03 - 03A	P - Positive	N - 0.150"	F- RoHS 6/6 (Lead Free)	A - 5 pins

MODEL LIST

Model Name	Packaging	Input Voltage	Output Voltage	Output Current	Efficiency 12Vin 5Vout@ 100%
NE12S0A0V03PNFA	Vertical	3.1V~ 13.8Vdc	0.59V~ 5.0Vdc	3A	92.5%
NE12S0A0H03PNFA	Horizontal	3.1V~ 13.8Vdc	0.59V~ 5.0Vdc	3A	92.5%

CONTACT: www.delta.com.tw/dcdc

USA:

Telephone:
East Coast: (888) 335 8201
West Coast: (888) 335 8208
Fax: (978) 656 3964
Email: DCDC@delta-corp.com

Europe:

Telephone: +41 31 998 53 11
Fax: +41 31 998 53 53
Email: DCDC@delta-es.tw

Asia & the rest of world:

Telephone: +886 3 4526107 ext. 6220
Fax: +886 3 4513485
Email: DCDC@delta.com.tw

WARRANTY

Delta offers a two (2) year limited warranty. Complete warranty information is listed on our web site or is available upon request from Delta.

Information furnished by Delta is believed to be accurate and reliable. However, no responsibility is assumed by Delta for its use, nor for any infringements of patents or other rights of third parties, which may result from its use. No license is granted by implication or otherwise under any patent or patent rights of Delta. Delta reserves the right to revise these specifications at any time, without notice.



Стандарт Электрон Связь

Мы молодая и активно развивающаяся компания в области поставок электронных компонентов. Мы поставляем электронные компоненты отечественного и импортного производства напрямую от производителей и с крупнейших складов мира.

Благодаря сотрудничеству с мировыми поставщиками мы осуществляем комплексные и плановые поставки широчайшего спектра электронных компонентов.

Собственная эффективная логистика и склад в обеспечивает надежную поставку продукции в точно указанные сроки по всей России.

Мы осуществляем техническую поддержку нашим клиентам и предпродажную проверку качества продукции. На все поставляемые продукты мы предоставляем гарантию .

Осуществляем поставки продукции под контролем ВП МО РФ на предприятия военно-промышленного комплекса России , а также работаем в рамках 275 ФЗ с открытием отдельных счетов в уполномоченном банке. Система менеджмента качества компании соответствует требованиям ГОСТ ISO 9001.

Минимальные сроки поставки, гибкие цены, неограниченный ассортимент и индивидуальный подход к клиентам являются основой для выстраивания долгосрочного и эффективного сотрудничества с предприятиями радиоэлектронной промышленности, предприятиями ВПК и научно-исследовательскими институтами России.

С нами вы становитесь еще успешнее!

Наши контакты:

Телефон: +7 812 627 14 35

Электронная почта: sales@st-electron.ru

Адрес: 198099, Санкт-Петербург,
Промышленная ул, дом № 19, литера Н,
помещение 100-Н Офис 331