

FEATURES

- SNR = 65.8 dBFS at f_{IN} up to 250 MHz at 500 MSPS**
- ENOB of 10.5 bits at f_{IN} up to 250 MHz at 500 MSPS (-1.0 dBFS)**
- SFDR = 80 dBc at f_{IN} up to 250 MHz at 500 MSPS (-1.0 dBFS)**
- Excellent linearity**
 - DNL = ± 0.5 LSB typical, INL = ± 0.6 LSB typical**
- Integrated 16k \times 12 FIFO**
- FIFO readback options**
 - 12-bit parallel CMOS at 62.5 MHz**
 - 6-bit DDR LVDS interface**
 - SPORT at 62.5 MHz**
 - SPI at 25 MHz**
- High speed synchronization capability**
- 1 GHz full power analog bandwidth**
- Integrated input buffer**
- On-chip reference, no external decoupling required**
- Low power dissipation**
 - 695 mW at 500 MSPS**
 - Programmable input voltage range**
 - 1.18 V to 1.6 V, 1.5 V nominal**
- 1.9 V analog and digital supply operation**
- 1.9 V or 3.3 V SPI and SPORT operation**
- Clock duty cycle stabilizer**
- Integrated data clock output with programmable clock and data alignment**

APPLICATIONS

- Wireless and wired broadband communications**
- Communications test equipment**
- Power amplifier linearization**

GENERAL DESCRIPTION

The AD6641 is a 250 MHz bandwidth digital predistortion (DPD) observation receiver that integrates a 12-bit 500 MSPS ADC, a 16k \times 12 FIFO, and a multimode back end that allows users to retrieve the data through a serial port (SPORT), the SPI interface, a 12-bit parallel CMOS port, or a 6-bit DDR LVDS port after being stored in the integrated FIFO memory. It is optimized for outstanding dynamic performance and low power consumption and is suitable for use in telecommunications applications such as a digital predistortion observation path where wider bandwidths are desired. All necessary functions, including the sample-and-hold and voltage reference, are included on the chip to provide a complete signal conversion solution.

The on-chip FIFO allows small snapshots of time to be captured via the ADC and read back at a lower rate. This reduces the constraints of signal processing by transferring the captured data at an arbitrary time and at a much lower sample rate. The FIFO can be operated in several user-programmable modes. In the single capture mode, the ADC data is captured when signaled via the SPI port or the use of the external FILL \pm pins. In the continuous capture mode, the data is loaded continuously into the FIFO and the FILL \pm pins are used to stop this operation.

FUNCTIONAL BLOCK DIAGRAM

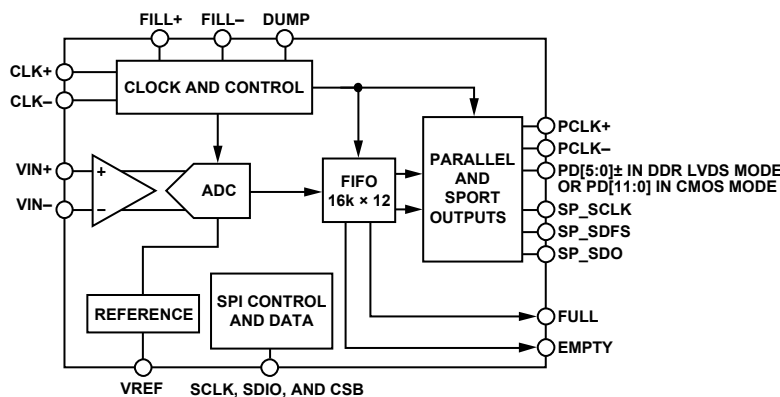

Figure 1.

Rev. 0

Information furnished by Analog Devices is believed to be accurate and reliable. However, no responsibility is assumed by Analog Devices for its use, nor for any infringements of patents or other rights of third parties that may result from its use. Specifications subject to change without notice. No license is granted by implication or otherwise under any patent or patent rights of Analog Devices. Trademarks and registered trademarks are the property of their respective owners.

TABLE OF CONTENTS

Features	1	Thermal Resistance	10
Applications.....	1	ESD Caution.....	10
General Description	1	Pin Configurations and Function Descriptions	11
Functional Block Diagram	1	Typical Performance Characteristics	15
Revision History	2	Equivalent Circuits.....	18
Product Highlights	3	SPI Register Map	20
Specifications.....	4	Theory of Operation	23
DC Specifications	4	FIFO Operation	23
AC Specifications.....	5	FIFO Output Interfaces	26
Digital Specifications	6	Configuration Using the SPI.....	27
Switching Specifications	7	Outline Dimensions	28
SPI Timing Requirements	8	Ordering Guide	28
Absolute Maximum Ratings.....	10		

REVISION HISTORY

4/11—Revision 0: Initial Version

The data stored in the FIFO can be read back based on several user-selectable output modes. The DUMP pin can be asserted to output the FIFO data. The data stored in the FIFO can be accessed via a SPORT, SPI, 12-bit parallel CMOS port, or 6-bit DDR LVDS interface. The maximum output throughput supported by the AD6641 is in the 12-bit CMOS or 6-bit DDR LVDS mode and is internally limited to 1/8th of the maximum input sample rate. This corresponds to the maximum output data rate of 62.5 MHz at an input clock rate of 500 MSPS.

The ADC requires a 1.9 V analog voltage supply and a differential clock for full performance operation. Output format options include twos complement, offset binary format, or Gray code. A data clock output is available for proper output data timing. Fabricated on an advanced SiGe BiCMOS process, the device is available in a 56-lead LFCSP and is specified over the industrial temperature range (−40°C to +85°C). This product is protected by a U.S. patent.

PRODUCT HIGHLIGHTS

1. High Performance ADC Core.
Maintains 65.8 dBFS SNR at 500 MSPS with a 250 MHz input.
2. Low Power.
Consumes only 695 mW at 500 MSPS.
3. Ease of Use.
On-chip 16k FIFO allows the user to target the high performance ADC to the time period of interest and reduce the constraints of processing the data by transferring it at an arbitrary time and a lower sample rate. The on-chip reference and sample-and-hold provide flexibility in system design. Use of a single 1.9 V supply simplifies system power supply design.
4. Serial Port Control.
Standard serial port interface supports configuration of the device and customization for the user's needs.
5. 1.9 V or 3.3 V SPI and Serial Data Port Operation.

AD6641

SPECIFICATIONS

DC SPECIFICATIONS

AVDD = 1.9 V, DRVDD = 1.9 V, T_{MIN} = -40°C, T_{MAX} = +85°C, f_{IN} = -1.0 dBFS, full scale = 1.5 V, unless otherwise noted.

Table 1.

Parameter ¹	Temp	AD6641-500			Unit
		Min	Typ	Max	
RESOLUTION			12		Bits
ACCURACY					
No Missing Codes	Full		Guaranteed		
Offset Error	Full	-2.6	0.0	+1.8	mV
Gain Error	Full	-6.8	-2.3	+3.3	% FS
Differential Nonlinearity (DNL)	Full		±0.5		LSB
Integral Nonlinearity (INL)	Full		±0.6		LSB
TEMPERATURE DRIFT					
Offset Error	Full		18		μV/°C
Gain Error	Full		0.07		%/°C
ANALOG INPUTS (VIN±)					
Differential Input Voltage Range ²	Full	1.18	1.5	1.6	V p-p
Input Common-Mode Voltage	Full		1.8		V
Input Resistance (Differential)	Full		1		kΩ
Input Capacitance (Differential)	25°C		1.3		pF
POWER SUPPLY					
AVDD	Full	1.8	1.9	2.0	V
DRVDD	Full	1.8	1.9	2.0	V
SPI_VDDIO	Full	1.8	1.9	3.3	V
Supply Currents					
I _{AVDD} ³	Full		300	330	mA
I _{DRVDD} ³	Full		66	80	mA
Power Dissipation ³	Full		695	779	mW
Power-Down Dissipation	Full		15		mW
Standby Dissipation	Full		72		mW
Standby to Power-Up Time	Full		10		μs

¹ See the AN-835 Application Note, *Understanding High Speed ADC Testing and Evaluation*, for a complete set of definitions and information about how these tests were completed.

² The input range is programmable through the SPI, and the range specified reflects the nominal values of each setting. See the SPI Register Map section for additional details.

³ I_{AVDD} and I_{DRVDD} are measured with a -1 dBFS, 30 MHz sine input at a rated sample rate.

AC SPECIFICATIONS

AVDD = 1.9 V, DRVDD = 1.9 V, T_{MIN} = -40°C, T_{MAX} = +85°C, f_{IN} = -1.0 dBFS, full scale = 1.5 V, unless otherwise noted.

Table 2.

Parameter ^{1,2}	Temp	AD6641-500			Unit
		Min	Typ	Max	
SNR					
f _{IN} = 30 MHz	25°C		66.0		dBFS
f _{IN} = 125 MHz	25°C		65.9		dBFS
	Full	65.0			dBFS
f _{IN} = 250 MHz	25°C		65.8		dBFS
f _{IN} = 450 MHz	25°C		65.1		dBFS
SINAD					
f _{IN} = 30 MHz	25°C		66.0		dBFS
f _{IN} = 125 MHz	25°C		65.7		dBFS
	Full	63.8			dBFS
f _{IN} = 250 MHz	25°C		65.3		dBFS
f _{IN} = 450 MHz	25°C		64.6		dBFS
EFFECTIVE NUMBER OF BITS (ENOB)					
f _{IN} = 30 MHz	25°C		10.7		Bits
f _{IN} = 125 MHz	25°C		10.6		Bits
f _{IN} = 250 MHz	25°C		10.5		Bits
f _{IN} = 450 MHz	25°C		10.4		Bits
SFDR					
f _{IN} = 30 MHz	25°C		88		dBc
f _{IN} = 125 MHz	25°C		83		dBc
	Full	77			dBc
f _{IN} = 250 MHz	25°C		80		dBc
f _{IN} = 450 MHz	25°C		72		dBc
WORST HARMONIC (SECOND OR THIRD)					
f _{IN} = 30 MHz	25°C		-92		dBc
f _{IN} = 125 MHz	25°C			-77	dBc
	Full		-84		dBc
f _{IN} = 250 MHz	25°C		-80		dBc
f _{IN} = 450 MHz	25°C		-72		dBc
WORST OTHER HARMONIC (SFDR EXCLUDING SECOND AND THIRD)					
f _{IN} = 30 MHz	25°C		-90		dBc
f _{IN} = 125 MHz	25°C		-90		dBc
	Full			-77	dBc
f _{IN} = 250 MHz	25°C		-85		dBc
f _{IN} = 450 MHz	25°C		-78		dBc
TWO-TONE IMD					
f _{IN1} = 119.8 MHz, f _{IN2} = 125.8 MHz (-7 dBFS, Each Tone)	25°C		-82		dBc
ANALOG INPUT BANDWIDTH	25°C		1		GHz

¹ All ac specifications tested by driving CLK+ and CLK- differentially.

² See the AN-835 Application Note, *Understanding High Speed ADC Testing and Evaluation*, for a complete set of definitions and information about how these tests were completed.

AD6641

DIGITAL SPECIFICATIONS

AVDD = 1.9 V, DRVDD = 1.9 V, T_{MIN} = -40°C, T_{MAX} = +85°C, f_{IN} = -1.0 dBFS, full scale = 1.5 V, unless otherwise noted.

Table 3.

Parameter ¹	Temp	AD6641-500			Unit
		Min	Typ	Max	
CLOCK INPUTS (CLK±)					
Logic Compliance	Full	CMOS/LVDS/LVPECL			
Internal Common-Mode Bias	Full	0.9			V
Differential Input Voltage					
High Level Input (V _{IH})	Full	0.2		1.8	V p-p
Low Level Input (V _{IL})	Full	-1.8		-0.2	V p-p
High Level Input Current (I _{IH})	Full	-10		+10	μA
Low Level Input Current (I _{IL})	Full	-10		+10	μA
Input Resistance (Differential)	Full	8	10	12	kΩ
Input Capacitance	Full		4		pF
LOGIC INPUTS (SPI, SPORT)					
Logic Compliance	Full	CMOS			
Logic 1 Voltage	Full	0.8 × SPI_VDDIO			V
Logic 0 Voltage	Full		0.2 × SPI_VDDIO		V
Logic 1 Input Current (SDIO)	Full		0		μA
Logic 0 Input Current (SDIO)	Full		-60		μA
Logic 1 Input Current (SCLK)	Full		50		μA
Logic 0 Input Current (SCLK)	Full		0		μA
Input Capacitance	25°C		4		pF
LOGIC INPUTS (DUMP, CSB)					
Logic Compliance	Full	CMOS			
Logic 1 Voltage	Full	0.8 × DRVDD			V
Logic 0 Voltage	Full		0.2 × DRVDD		V
Logic 1 Input Current	Full		0		μA
Logic 0 Input Current	Full		-60		μA
Input Capacitance	25°C		4		pF
LOGIC INPUTS (FILL±)					
Logic Compliance	Full	CMOS/LVDS/LVPECL			
Internal Common-Mode Bias	Full	0.9			V
Differential Input Voltage					
High Level Input (V _{IH})	Full	0.2		1.8	V p-p
Low Level Input (V _{IL})	Full	-1.8		-0.2	V p-p
High Level Input Current (I _{IH})	Full	-10		+10	μA
Low Level Input Current (I _{IL})	Full	-10		+10	μA
Input Resistance (Differential)	Full	8	10	12	kΩ
Input Capacitance	Full		4		pF
LOGIC OUTPUTS² (FULL, EMPTY)					
Logic Compliance	Full	CMOS			
High Level Output Voltage	Full	DRVDD - 0.05			V
Low Level Output Voltage	Full		DRGND + 0.05		V
LOGIC OUTPUTS² (SPI, SPORT)					
Logic Compliance	Full	CMOS			
High Level Output Voltage	Full	SPI_VDDIO - 0.05			V
Low Level Output Voltage	Full		DRGND + 0.05		V

Parameter ¹	Temp	AD6641-500			Unit
		Min	Typ	Max	
LOGIC OUTPUTS					
DDR LVDS Mode (PCLK±, PD[5:0]±, PDOR±)					
Logic Compliance	Full		LVDS		
V _{OD} Differential Output Voltage	Full	247		454	mV
V _{OS} Output Offset Voltage	Full	1.125		1.375	V
Parallel CMOS Mode (PCLK±, PD[11:0])					
Logic Compliance	Full		CMOS		
High Level Output Voltage	Full	DRVDD – 0.05			V
Low Level Output Voltage	Full			DRGND + 0.05	V
Output Coding		Twos complement, Gray code, or offset binary (default)			

¹ See the [AN-835](#) Application Note, *Understanding High Speed ADC Testing and Evaluation*, for a complete set of definitions and information about how these tests were completed.

² 5 pF loading.

SWITCHING SPECIFICATIONS

AVDD = 1.9 V, DRVDD = 1.9 V, T_{MIN} = –40°C, T_{MAX} = +85°C, f_{IN} = –1.0 dBFS, full scale = 1.5 V, unless otherwise noted.

Table 4.

Parameter ¹	Temp	AD6641-500			Unit
		Min	Typ	Max	
OUTPUT DATA RATE					
Maximum Output Data Rate (Decimate by 8 at 500 MSPS Sample Rate, Parallel CMOS or DDR LVDS Mode Interface)	Full	62.5			MHz
Maximum Output Data Rate (Decimate by 8 at 500 MSPS Sample Rate, SPORT Mode)	Full	62.5			MHz
PULSE WIDTH/PERIOD (CLK±)					
CLK± Pulse Width High (t _{CH})	Full		1		ns
CLK± Pulse Width Low (t _{CL})	Full		1		ns
Rise Time (t _R) (20% to 80%)	25°C		0.2		ns
Fall Time (t _F) (20% to 80%)	25°C		0.2		ns
PULSE WIDTH/PERIOD (PCLK±, DDR LVDS MODE)					
PCLK± Pulse Width High (t _{PCLK,CH})	Full		8		ns
PCLK± Period (t _{PCLK})	Full		16		ns
Propagation Delay (t _{CPD} , CLK± to PCLK±)	Full		±0.1		ns
Rise Time (t _R) (20% to 80%)	25°C		0.2		ns
Fall Time (t _F) (20% to 80%)	25°C		0.2		ns
Data to PCLK Skew (t _{SKEW})	Full		0.2		ns
SERIAL PORT OUTPUT TIMING ²					
SP_SDFS Propagation Delay (t _{DSDFS})	Full		3		ns
SP_SDO Propagation Delay (t _{DSDO})	Full		3		ns
SERIAL PORT INPUT TIMING					
SP_SDFS Setup Time (t _{SSF})	Full		2		ns
SP_SDFS Hold Time (t _{HSF})	Full		2		ns
FILL± INPUT TIMING					
FILL± Setup Time (t _{Sfill})	Full		0.5		ns
FILL± Hold Time (t _{Hfill})	Full		0.7		ns
APERTURE DELAY (t _A)	25°C		0.85		ns
APERTURE UNCERTAINTY (JITTER, t _J)	25°C		80		fs rms

¹ See the [AN-835](#) Application Note, *Understanding High Speed ADC Testing and Evaluation*, for a complete set of definitions and information about how these tests were completed.

² 5 pF loading.

SPI TIMING REQUIREMENTS

Table 5.

Parameter	Description	Limit	Unit
t_{DS}	Setup time between the data and the rising edge of SCLK	2	ns min
t_{DH}	Hold time between the data and the rising edge of SCLK	2	ns min
t_{CLK}	Period of the SCLK	40	ns min
t_S	Setup time between CSB and SCLK	2	ns min
t_H	Hold time between CSB and SCLK	2	ns min
t_{HIGH}	SCLK pulse width high	10	ns min
t_{LOW}	SCLK pulse width low	10	ns min
t_{EN_SDIO}	Time required for the SDIO pin to switch from an input to an output relative to the SCLK falling edge	10	ns min
t_{DIS_SDIO}	Time required for the SDIO pin to switch from an output to an input relative to the SCLK rising edge	10	ns min

Timing Diagrams

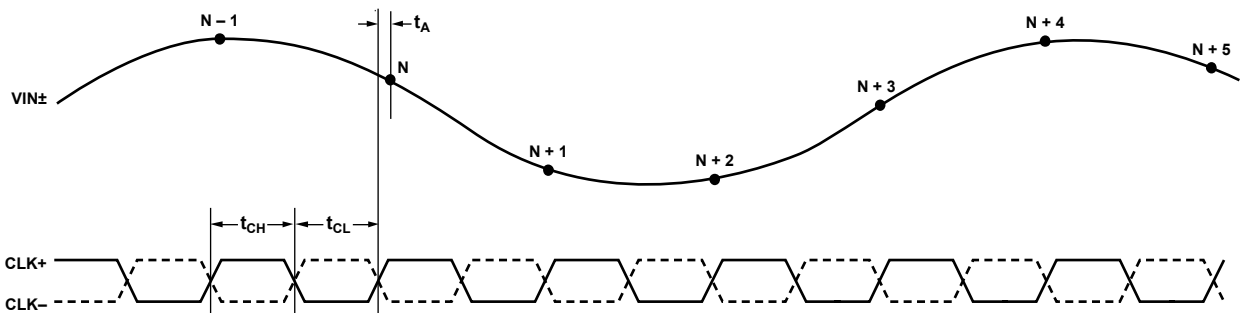

Figure 2. Input Interface Timing

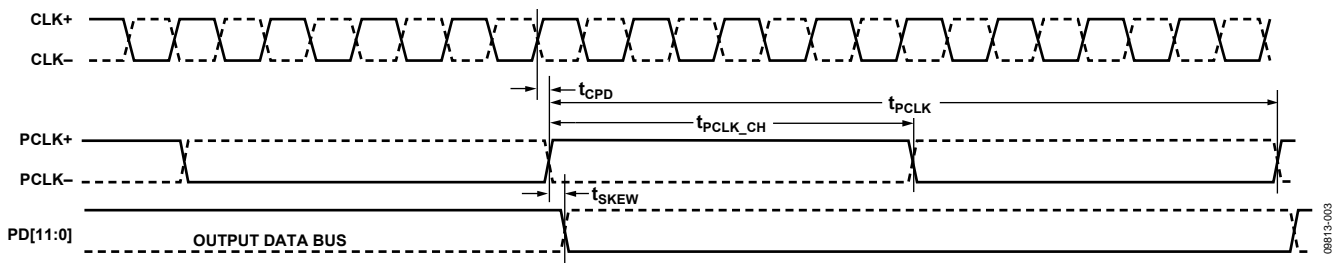

Figure 3. Parallel CMOS Mode Output Interface Timing

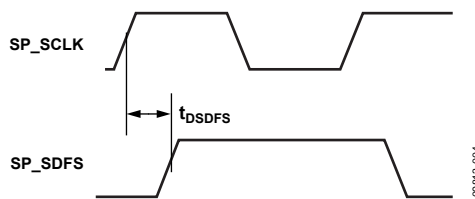

Figure 4. SP_SDFS Propagation Delay

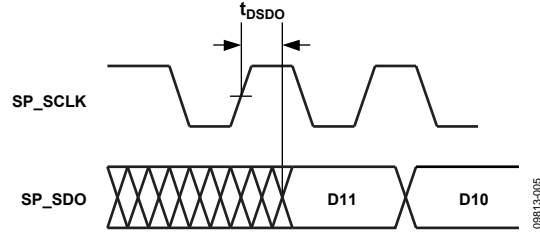

Figure 5. SP_SDO Propagation Delay

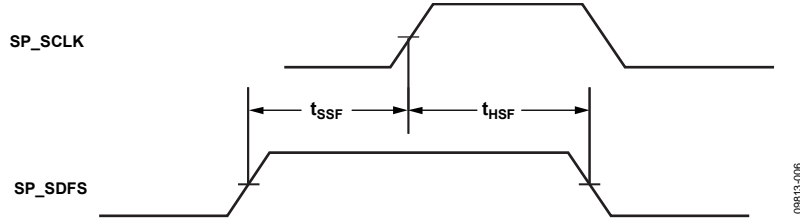

Figure 6. Slave Mode SP_SDFS Setup/Hold Time

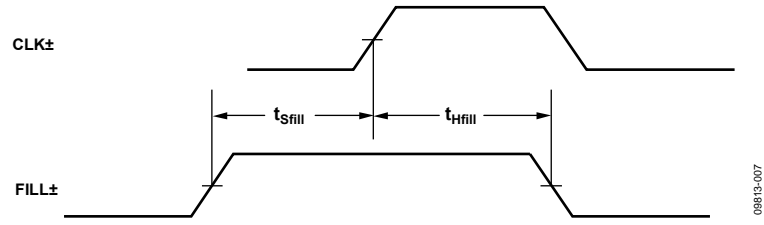

Figure 7. FILL± Setup and Hold Times

ABSOLUTE MAXIMUM RATINGS

Table 6.

Parameter	Rating
Electrical	
AVDD to AGND	−0.3 V to +2.0 V
DRVDD to DRGND	−0.3 V to +2.0 V
AGND to DRGND	−0.3 V to +0.3 V
AVDD to DRVDD	−2.0 V to +2.0 V
SPI_VDDIO to AVDD	−2.0 V to +2.0 V
SPI_VDDIO to DRVDD	−2.0 V to +2.0 V
PD[5:0]± to DRGND	−0.3 V to DRVDD + 0.2 V
PCLK± to DRGND	−0.3 V to DRVDD + 0.2 V
PDOR± to DRGND	−0.3 V to DRVDD + 0.2 V
FULL to DRGND	−0.3 V to DRVDD + 0.2 V
CLK± to AGND	−0.3 V to AVDD + 0.2 V
FILL± to AGND	−0.3 V to DRVDD + 0.2 V
DUMP to AGND	−0.3 V to DRVDD + 0.2 V
EMPTY to AGND	−0.3 V to DRVDD + 0.2 V
VIN± to AGND	−0.3 V to AVDD + 0.2 V
VREF to AGND	−0.3 V to AVDD + 0.2 V
CML to AGND	−0.3 V to AVDD + 0.2 V
CSB to DRGND	−0.3 V to SPI_VDDIO + 0.3 V
SP_SCLK, SP_SDFS to AGND	−0.3 V to SPI_VDDIO + 0.3 V
SDIO to DRGND	−0.3 V to SPI_VDDIO + 0.3 V
SP_SDO to DRGND	−0.3 V to SPI_VDDIO + 0.3 V
Environmental	
Storage Temperature Range	−65°C to +125°C
Operating Temperature Range	−40°C to +85°C
Lead Temperature (Soldering, 10 sec)	300°C
Junction Temperature	150°C

Stresses above those listed under Absolute Maximum Ratings may cause permanent damage to the device. This is a stress rating only; functional operation of the device at these or any other conditions above those indicated in the operational section of this specification is not implied. Exposure to absolute maximum rating conditions for extended periods may affect device reliability.

THERMAL RESISTANCE

The exposed pad must be soldered to the ground plane for the LFCSP package. Soldering the exposed pad to the PCB increases the reliability of the solder joints, maximizing the thermal capability of the package.

Table 7.

Package Type	θ_{JA}	θ_{JC}	Unit
56-Lead LFCSP_VQ (CP-56-1)	23.7	1.7	°C/W

Typical θ_{JA} and θ_{JC} are specified for a 4-layer board in still air. Airflow increases heat dissipation, effectively reducing θ_{JA} . In addition, metal in direct contact with the package leads from metal traces, through holes, ground, and power planes reduces the θ_{JA} .

ESD CAUTION



ESD (electrostatic discharge) sensitive device.

Charged devices and circuit boards can discharge without detection. Although this product features patented or proprietary protection circuitry, damage may occur on devices subjected to high energy ESD. Therefore, proper ESD precautions should be taken to avoid performance degradation or loss of functionality.

PIN CONFIGURATIONS AND FUNCTION DESCRIPTIONS

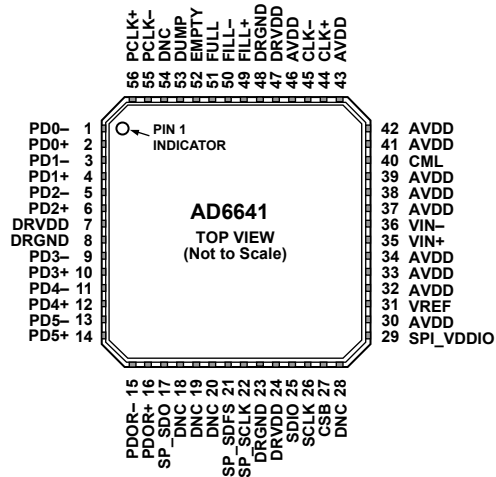

NOTES

1. DNC = DO NOT CONNECT. DO NOT CONNECT TO THIS PIN.
2. THE EXPOSED PAD IS THE ONLY ANALOG GROUND CONNECTION FOR THE CHIP. IT MUST BE CONNECTED TO PCB AGND.

09813-008

Figure 8. Pin Configuration for DDR LVDS Mode

Table 8. DDR LVDS Mode Pin Function Descriptions

Pin No.	Mnemonic	Description
0	EPAD	Exposed Pad. The exposed pad is the only ground connection for the chip. The pad must be connected to PCB AGND.
1	PD0-	PD0 Data Output (LSB)—Complement.
2	PD0+	PD0 Data Output (LSB)—True.
3	PD1-	PD1 Data Output—Complement.
4	PD1+	PD1 Data Output—True.
5	PD2-	PD2 Data Output—Complement.
6	PD2+	PD2 Data Output—True.
7, 24, 47	DRVDD	1.9 V Digital Output Supply.
8, 23, 48	DRGND	Digital Output Ground.
9	PD3-	PD3 Data Output—Complement.
10	PD3+	PD3 Data Output—True.
11	PD4-	PD4 Data Output—Complement.
12	PD4+	PD4 Data Output—True.
13	PD5-	PD5 Data Output (MSB)—Complement.
14	PD5+	PD5 Data Output (MSB)—True.
15	PDOR-	Overrange Output—Complement.
16	PDOR+	Overrange Output—True.
17	SP_SDO	SPORT Output.
18, 19, 20, 28, 54	DNC	Do Not Connect. Do not connect to this pin.
21	SP_SDFS	SPORT Frame Sync Input (Slave Mode)/Output (Master Mode).
22	SP_SCLK	SPORT Clock Input (Slave Mode)/Output (Master Mode).
25	SDIO	Serial Port Interface (SPI) Data Input/Output (Serial Port Mode).
26	SCLK	Serial Port Interface Clock (Serial Port Mode).
27	CSB	Serial Port Chip Select (Active Low).
29	SPI_VDDIO	1.9 V or 3.3 V SPI I/O Supply.
30, 32, 33, 34, 37, 38, 39, 41, 42, 43, 46	AVDD	1.9 V Analog Supply.
31	VREF	Voltage Reference Input/Output. Nominally 0.75 V.
35	VIN+	Analog Input—True.
36	VIN-	Analog Input—Complement.

AD6641

Pin No.	Mnemonic	Description
40	CML	Common-Mode Output. Enabled through the SPI, this pin provides a reference for the optimized internal bias voltage for VIN+ and VIN-.
44	CLK+	Clock Input—True.
45	CLK-	Clock Input—Complement.
49	FILL+	FIFO Fill Input (LVDS)—True.
50	FILL-	FIFO Fill Input (LVDS)—Complement.
51	FULL	FIFO Full Output Indicator.
52	EMPTY	FIFO Empty Output Indicator.
53	DUMP	FIFO Readback Input.
55	PCLK-	Data Clock Output—Complement.
56	PCLK+	Data Clock Output—True.

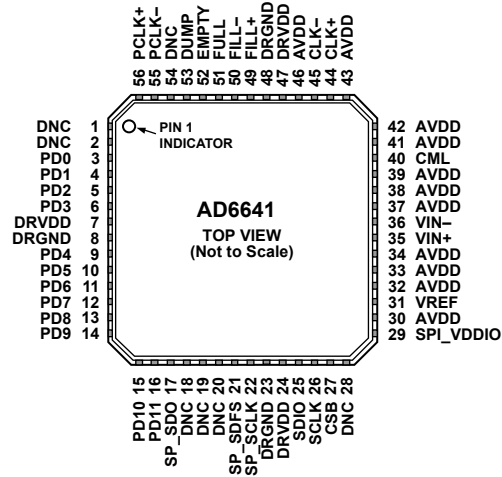

1. DNC = DO NOT CONNECT. DO NOT CONNECT TO THIS PIN.
2. THE EXPOSED PAD IS THE ONLY ANALOG GROUND CONNECTION FOR THE CHIP. IT MUST BE CONNECTED TO PCB AGND.

09813-009

Figure 9. Pin Configuration for Parallel CMOS Mode

Table 9. Parallel CMOS Mode Pin Function Descriptions

Pin No.	Mnemonic	Description
0	EPAD	Exposed Pad. The exposed pad is the only ground connection for the chip. The pad must be connected to PCB AGND.
1, 2, 18, 19, 20, 28, 54	DNC	Do Not Connect. Do not connect to this pin.
3	PD0	PD0 Data Output.
4	PD1	PD1 Data Output.
5	PD2	PD2 Data Output.
6	PD3	PD3 Data Output.
7, 24, 47	DRVDD	1.9 V Digital Output Supply.
8, 23, 48	DRGND	Digital Output Ground.
9	PD4	PD4 Data Output.
10	PD5	PD5 Data Output.
11	PD6	PD6 Data Output.
12	PD7	PD7 Data Output.
13	PD8	PD8 Data Output.
14	PD9	PD9 Data Output.
15	PD10	PD10 Data Output.
16	PD11	PD11 Data Output (MSB).
17	SP_SDO	SPORT Output.
21	SP_SDFS	SPORT Frame Sync Input (Slave Mode)/Output (Master Mode).
22	SP_SCLK	SPORT Clock Input (Slave Mode)/Output (Master Mode).
25	SDIO	Serial Port Interface (SPI) Data Input/Output (Serial Port Mode).
26	SCLK	Serial Port Interface Clock (Serial Port Mode).
27	CSB	Serial Port Chip Select (Active Low).
29	SPI_VDDIO	1.9 V or 3.3 V SPI I/O Supply.
30, 32, 33, 34, 37, 38, 39, 41, 42, 43, 46	AVDD	1.9 V Analog Supply.
31	VREF	Voltage Reference Input/Output. Nominally 0.75 V.
35	VIN+	Analog Input—True.
36	VIN-	Analog Input—Complement.
40	CML	Common-Mode Output. Enabled through the SPI, this pin provides a reference for the optimized internal bias voltage for VIN+ and VIN-.
44	CLK+	Clock Input—True.

AD6641

Pin No.	Mnemonic	Description
45	CLK-	Clock Input—Complement.
49	FILL+	FIFO Fill Input (LVDS)—True.
50	FILL-	FIFO Fill Input (LVDS)—Complement.
51	FULL	FIFO Full Output Indicator.
52	EMPTY	FIFO Empty Output Indicator.
53	DUMP	FIFO Readback Input.
55	PCLK-	Data Clock Output—Complement.
56	PCLK+	Data Clock Output—True.

TYPICAL PERFORMANCE CHARACTERISTICS

AVDD = 1.9 V, DRVDD = 1.9 V, rated sample rate, $T_A = 25^\circ\text{C}$, 1.5 V p-p differential input, $A_{IN} = -1$ dBFS, unless otherwise noted.

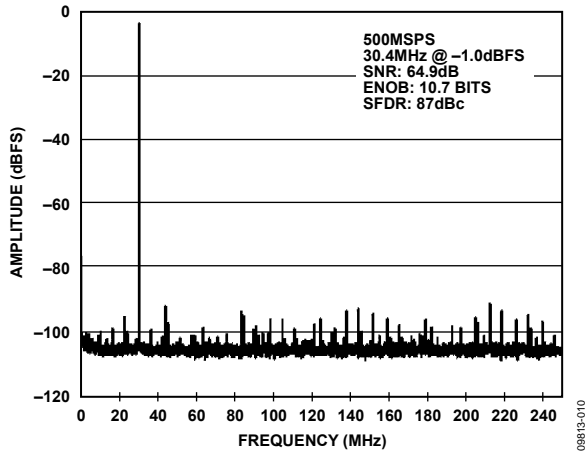

Figure 10. 16k Point Single-Tone FFT; 500 MSPS, 30.4 MHz

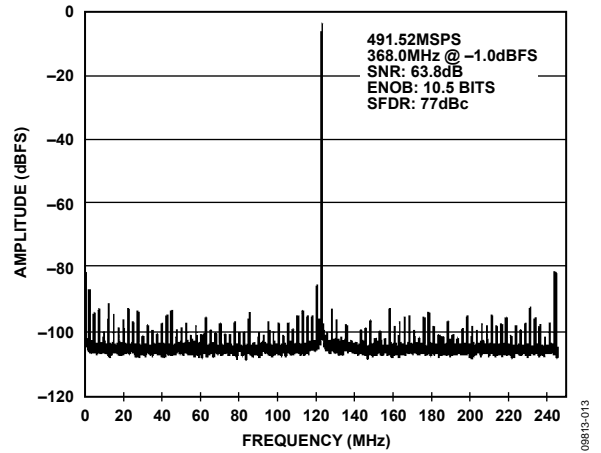

Figure 13. 16k Point Single-Tone FFT; 491.52 MSPS, 368.0 MHz

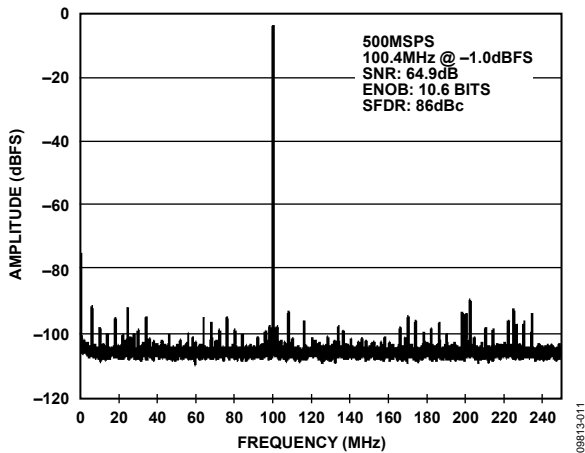

Figure 11. 16k Point Single-Tone FFT; 500 MSPS, 100.4 MHz

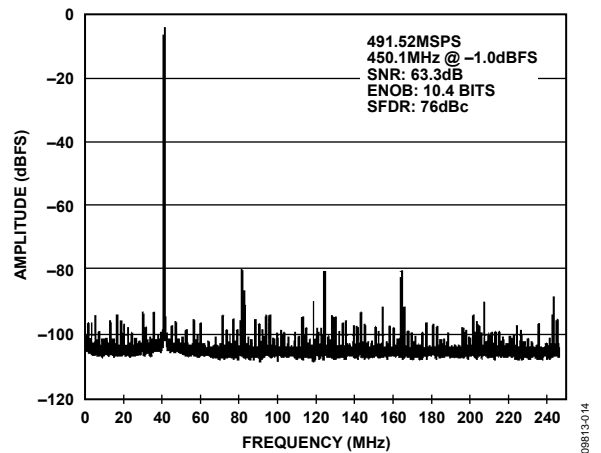

Figure 14. 16k Point Single-Tone FFT; 491.52 MSPS, 450.1 MHz

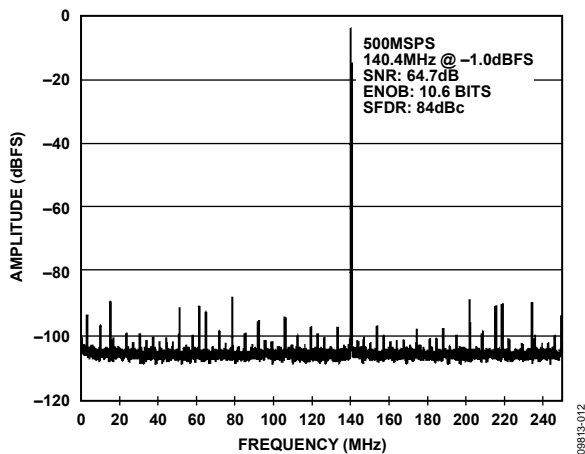

Figure 12. 16k Point Single-Tone FFT; 500 MSPS, 140.4 MHz

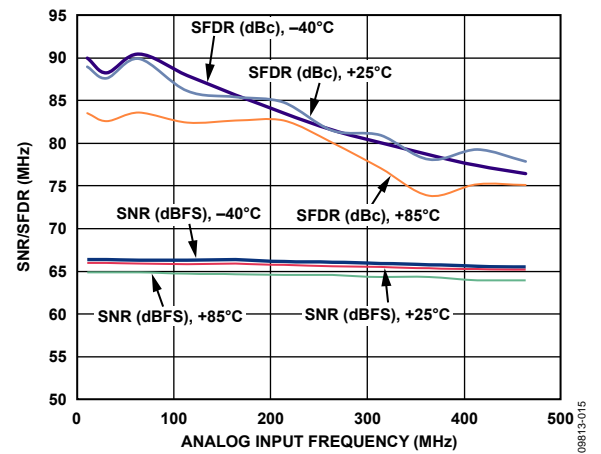

Figure 15. Single-Tone SNR/SFDR vs. Input Frequency (f_{IN}) and Temperature; 500 MSPS

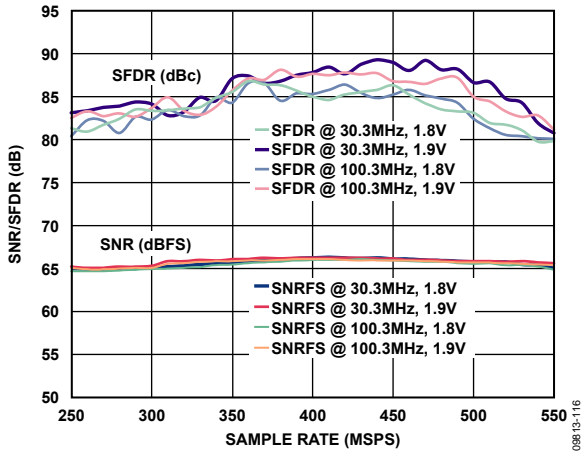

Figure 16. SNR/SFDR vs. Sample Rate and Supply

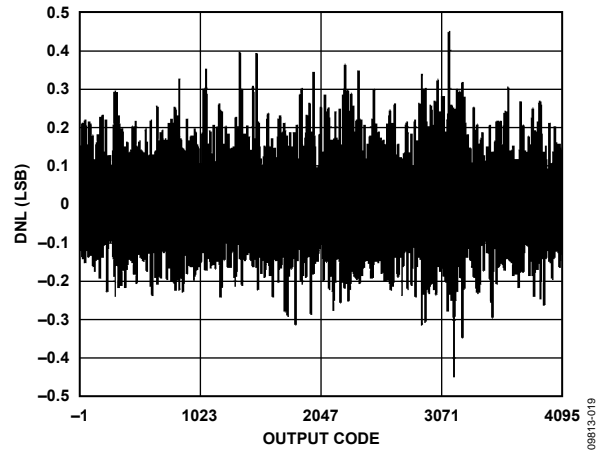

Figure 19. DNL; 500 MSPS

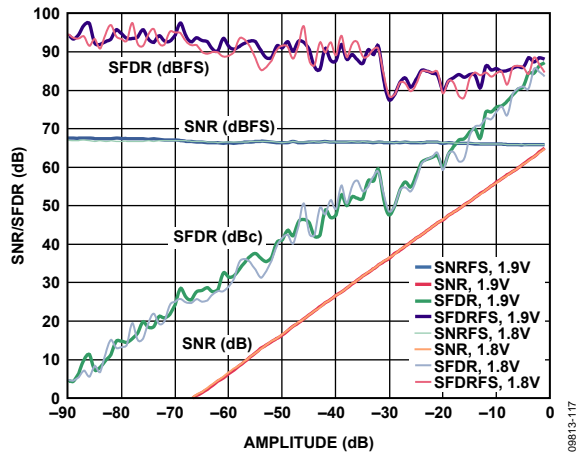

Figure 17. SNR/SFDR vs. Input Amplitude; 500 MSPS, 140.3 MHz

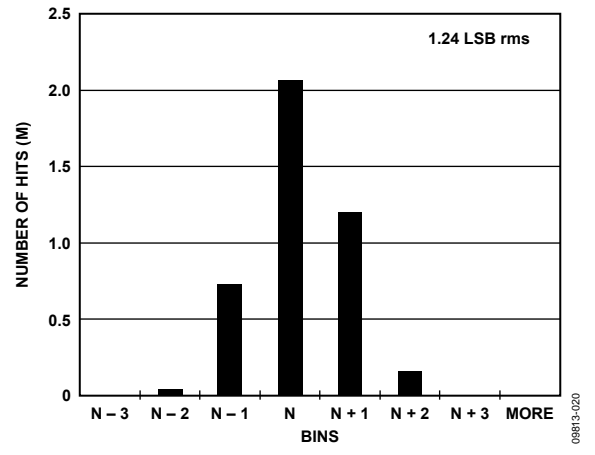

Figure 20. Grounded Input Histogram; 500 MSPS

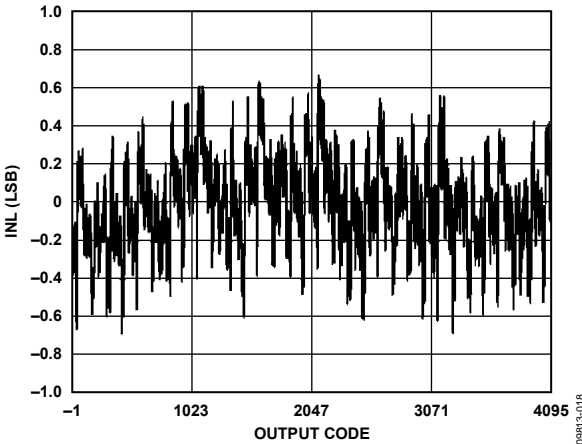

Figure 18. INL; 500 MSPS

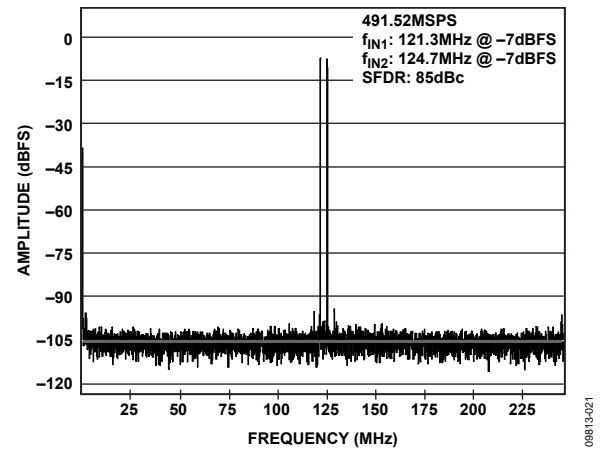

Figure 21. 16k Point Single-Tone FFT; 491.52 MSPS, $f_{IN1} = 121.3 \text{ MHz}$, $f_{IN2} = 124.7 \text{ MHz}$

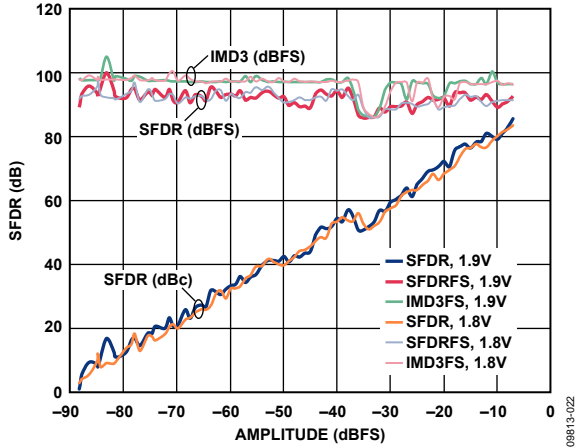

Figure 22. Two-Tone SFDR vs. Input Amplitude; 500 MSPS, 119.2 MHz, 122.5 MHz

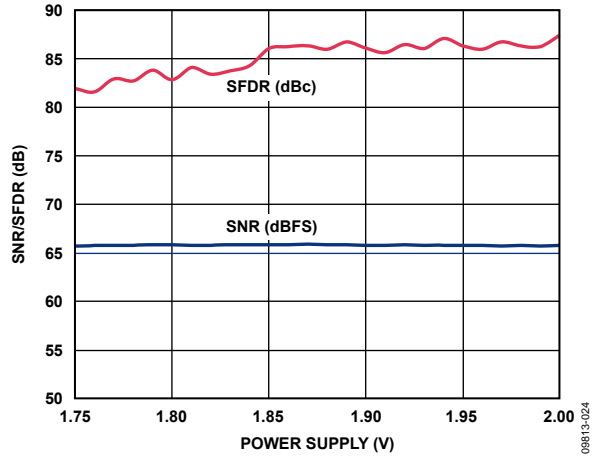

Figure 24. SNR/SFDR vs. Power Supply

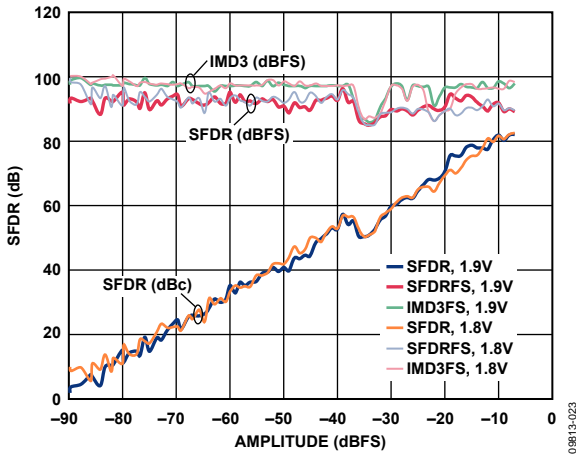

Figure 23. Two-Tone SFDR vs. Input Amplitude; 500 MSPS, 139.3 MHz, 141.3 MHz

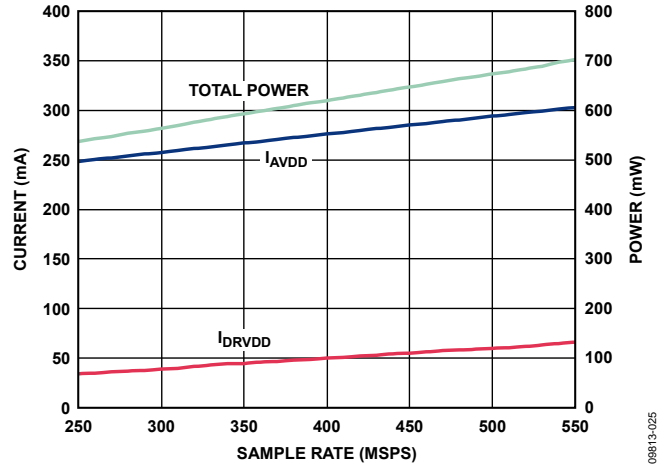

Figure 25. Current and Power vs. Sample Rate

EQUIVALENT CIRCUITS

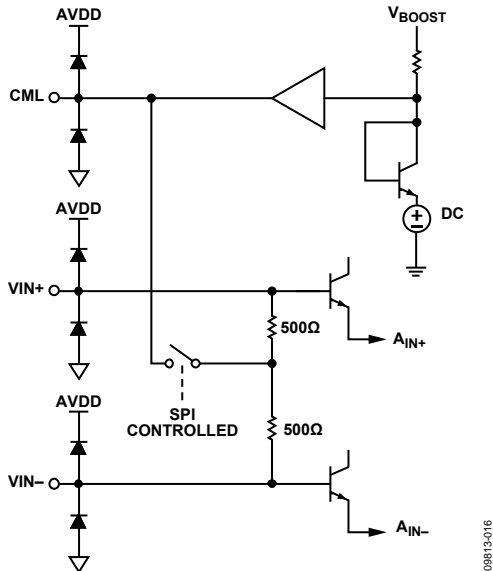

Figure 26. DC Equivalent Analog Input Circuit

08813-016

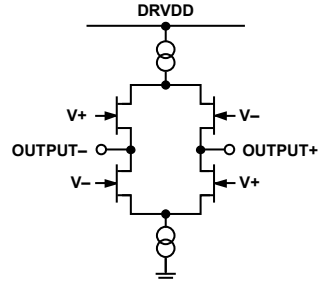

Figure 30. LVDS Outputs (PDOR±, PD[5:0]±, PCLK±)

08813-110

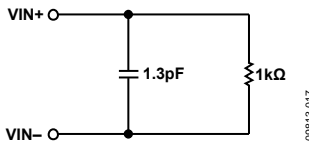

Figure 27. AC Equivalent Analog Input Circuit

08813-017

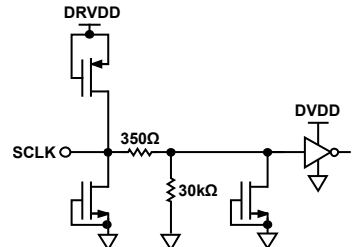

Figure 31. Equivalent SCLK Input Circuit

08813-129

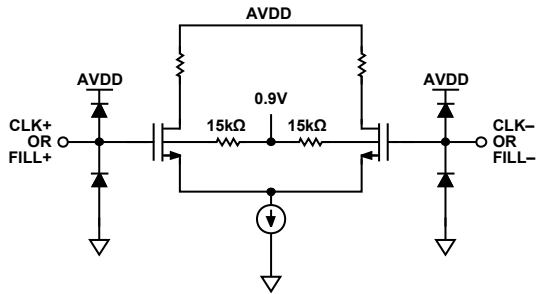

Figure 28. Equivalent CLK± and FILL± Input Circuit

08813-127

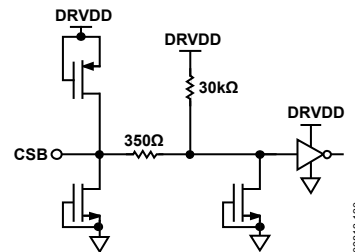

Figure 32. Equivalent CSB Input Circuit

08813-130

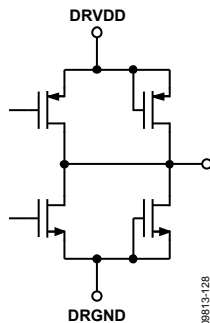

Figure 29. Equivalent PD[11:0], FULL, EMPTY, PCLK±, and SP_SDO Output Circuit

08813-128

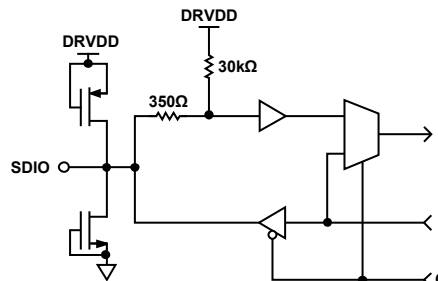

Figure 33. Equivalent SDIO Circuit

08813-131

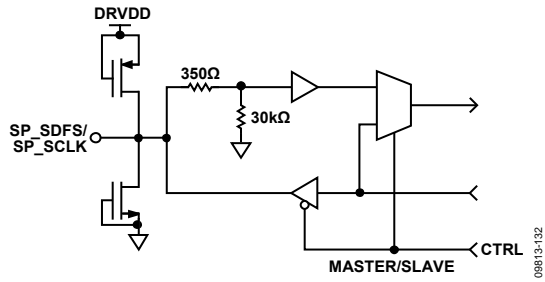

Figure 34. Equivalent SP_SDFS and SP_SCLK Circuit

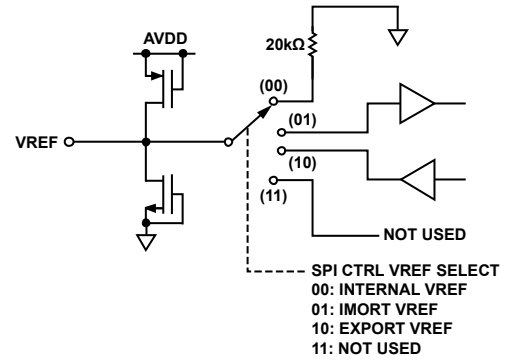

Figure 35. Equivalent VREF Circuit

SPI REGISTER MAP

Table 10. Memory Map Register

Addr. (Hex)	Parameter Name	Bit 7 (MSB)	Bit 6	Bit 5	Bit 4	Bit 3	Bit 2	Bit 1	Bit 0 (LSB)	Default Value (Hex)	Default Notes/ Comments
Chip Configuration Registers											
0x00	CHIP_PORT_CONFIG	0	LSB first	Soft reset	1	1	Soft reset	LSB first	0	0x18	The nibbles should be mirrored by the user so that LSB or MSB first mode registers correctly, regardless of shift mode.
0x01	CHIP_ID	8-bit chip ID, Bits[7:0] = 0xA0								Read only	Default is unique chip ID, different for each device. This is a read-only register.
0x02	CHIP_GRADE	0	0	Speed grade: 10 = 500 MSPS	X ¹	X ¹	X ¹	X ¹	X ¹	Read only	Child ID used to differentiate graded devices.
Transfer Register											
0xFF	DEVICE_UPDATE	[7:1] = 0000000							SW transfer	0x00	Synchronously transfers data from the master shift register to the slave.
ADC Functions											
0x08	Modes	0	0	0	0	0	Internal power-down mode: 000 = normal (power-up, default) 001 = full power-down 010 = standby 011 = reserved			0x00	Determines various generic modes of chip operation.
0x0D	TEST_IO	(For user-defined mode only, set Bits[3:0] = 1000) 00 = Pattern 1 only 01 = toggle Pattern 1/ Pattern 2 10 = toggle Pattern 1/0000 11 = toggle Pattern 1/ Pattern 2/0000		Reset PN23 gen: 1 = on 0 = off (default)	Reset PN9 gen: 1 = on 0 = off (default)	Output test mode: 0000 = off (default) 0001 = midscale short 0010 = +FS short 0011 = -FS short 0100 = checkerboard output 0101 = PN23 sequence 0110 = PN9 0111 = one/zero word toggle 1000 = user defined 1001 = unused 1010 = unused 1011 = unused 1100 = unused (format determined by OUTPUT_MODE)				0x00	When set, the test data is placed on the output pins in place of normal data. Set pattern values: Pattern 1: Reg 0x19, Reg 0x1A Pattern 2: Reg 0x1B, Reg 0x1C.
0x14	OUTPUT_MODE	0	0	0	Output disable: 0 = enable (default) 1 = disable	0 = CMOS: 1 = LVDS (default)	Output invert: 1 = on 0 = off (default)	Data format select: 00 = offset binary (default) 01 = twos complement 10 = Gray code 11 = reserved		0x08	

Addr. (Hex)	Parameter Name	Bit 7 (MSB)	Bit 6	Bit 5	Bit 4	Bit 3	Bit 2	Bit 1	Bit 0 (LSB)	Default Value (Hex)	Default Notes/ Comments
0x15	OUTPUT_ADJUST	[7:4] = 0000				LVDS course adjust: 0 = 3.5 mA (default) 1 = 2.0 mA	LVDS fine adjust: 001 = 3.50 mA 010 = 3.25 mA 011 = 3.00 mA 100 = 2.75 mA 101 = 2.50 mA 110 = 2.25 mA 111 = 2.00 mA			0x00	
0x16	OUTPUT_PHASE	Output clock polarity: 1 = inverted 0 = normal (default)	[6:0] = 0000000						0x03		
0x17	OUTPUT_DELAY	0	0	0	0	Output clock delay: 0000 = 0 0001 = -1/10 0010 = -2/10 0011 = -3/10 0100 = reserved 0101 = +5/10 0110 = +4/10 0111 = +3/10 1000 = +2/10 1001 = +1/10			0	Shown as fractional value of sampling clock period that is subtracted or added to initial t_{SKEW} , see Figure 3).	
0x18	Input range	VREF select: 00 = internal V_{REF} (20 k Ω pull-down) 01 = import V_{REF} (0.59 V to 0.80 V on VREF pin) 10 = export V_{REF} 11 = not used		0	Input voltage range setting (V): 11100 = 1.60 11101 = 1.58 11110 = 1.55 11111 = 1.52 00000 = 1.50 00001 = 1.47 00010 = 1.44 00011 = 1.42 00100 = 1.39 00101 = 1.36 00110 = 1.34 00111 = 1.31 01000 = 1.28 01001 = 1.26 01010 = 1.23 01011 = 1.20 01100 = 1.18					0	
0x19	USER_PATT1_LSB	[7:0]						0	User Defined Pattern 1 LSB.		
0x1A	USER_PATT1_MSB	[7:0]						0	User Defined Pattern 1 MSB.		
0x1B	USER_PATT2_LSB	[7:0]						0	User Defined Pattern 2 LSB.		
0x1C	USER_PATT2_MSB	[7:0]						0	User Defined Pattern 2 MSB.		
Digital Controls											
0x101	Fill control register	Reserved	Fill input pin disable	Reserved	LIFO mode	FIFO fill mode: 00 = single 01 = continuous 1x = reserved		Reserved	Standby after fill	0	
0x102	FIFO Config	[7:4] = reserved				Dump reset	Fill reset	Dump	Fill	0	
0x104	Fill count	[7:0]						0x7F	Number of words to use for fill or dump.		

AD6641

Addr. (Hex)	Parameter Name	Bit 7 (MSB)	Bit 6	Bit 5	Bit 4	Bit 3	Bit 2	Bit 1	Bit 0 (LSB)	Default Value (Hex)	Default Notes/Comments
0x105	Settle Count0	[7:0]								0	LSBs settling time given to ADC before initiating fill.
0x106	Settle Count1	[7:0]								0	MSBs settling time given to ADC before initiating fill.
0x107	Dump control	[7:3] = reserved					0 = slave 1 = master	Readback mode: 00 = off 01 = parallel 10 = SPORT 11 = reserved		0	Customer drives SP_SCLK, SP_SDFS in slave mode.
0x10A	FIFO status	[7:3] = reserved					Over-range	Empty	Full	0	
0x10B	FIFO Dump Data0	[7:0] = LSBs								0	LSBs readback data.
0x10C	FIFO Dump Data1	[7:4] = reserved				[3:0] = MSBs				0	MSBs upper four bits readback data.
0x10F	Read Offset Data0	[7:0] = LSBs								0	LSBs offset to RAM, allowing subsegments of data capture to be read.
0x110	Read Offset Data1	[7:6] = reserved		[5:0] = MSBs						0	MSB's offset.
0x111	PPORT control	[7:5] = reserved			Divide ratio = 2 × (bit word): 00100 = divide by 8 (default) ... 01111 = divide by 30 1xxxx = divide by 32					0x04	CMOS parallel port divide rate.
0x112	SPORT control	[7:5] = reserved			Divide ratio = 2 × (bit word): 00100 = divide by 8 (default) ... 01111 = divide by 30 1xxxx = divide by 32					0x04	Serial port divide rate.
0x13A	FIFO test BIST	[7:5] = reserved			Sets the BIST mode for the FIFO: 1xxx = reserved 0111 = reserved 0110 = 12'hFFF (-1 LSB) 0101 = 12'h001 (+1 LSB) 0100 = PN data 0011 = checkerboard (12'hAAA, 12'h555, 12'hAAA, ...) 0010 = checkerboard (12'h555, 12'hAAA, 12'h555, ...) 0001 = decremting ramp 0000 = incremting ramp				FIFO BIST enable	0	

¹X = don't care.

THEORY OF OPERATION

The on-chip FIFO allows small snapshots of time to be captured via the ADC and read back at a lower rate. This reduces the constraints of signal processing by transferring the captured data at an arbitrary time and at a much lower sample rate.

FIFO OPERATION

The capture of the data can be signaled through writes to the SPI port by pulsing the FILL± pins. The transaction diagram shown in Figure 36 illustrates the loading of the FIFO.

At Event 1, the FIFO is instructed to fill either by asserting the FILL± pins or via a write to the SPI bits. FILL± pin operation can be delayed by a programmable fill hold-off counter so that the FIFO data can be surrounding a fill event. The FIFO then loads itself with data. The number of samples of data is determined by the SPI fill count register (0x104). This is an 8-bit register with values from 0 to 255. The number of samples placed in the FIFO is determined by the following equation:

$$\text{Number of Samples} = (\text{FILL_CNT} + 1) \times 64$$

After the FIFO has begun filling at Event 2, the AD6641 asserts a full flag to indicate that the FIFO has finished capturing data and enters a wait state in which the device waits to receive the dump instruction from the DUMP pin or the SPI.

After the data has been shifted (Event 4), the FIFO goes into the idle state and waits for another fill command. During the idle state, the ADC can optionally be placed into standby mode to save power. If the ADC powers down in the idle state, initiating a fill operation (Event 1) powers up the ADC. In this mode, the ADC waits for settle count cycles (0x105, 0x106) before capturing the data. Settle count is programmable from the SPI port and

allows the analog circuitry to stabilize before taking data. An intelligent trade-off between speed of acquisition and accuracy can be made by using this register.

The data can be read back through any of the three output interfaces at a low data rate, which further saves power. If the SPI or SPORT is used to read back the data, the interface can require as few as three pins. A full flag and an empty flag are provided to signal the state of the FIFO. The FIFO status register (0x10A) in the SPI also allows this to be monitored via software.

Single Capture Mode

The FIFO can be placed into single capture mode by writing the FIFO fill mode bits in the fill control register (0x101[3:2]) to 00. In the single capture mode, the user initiates a capture either by driving the FILL± pins high or by initiating a fill command through the SPI port by writing the standby after fill bit (0x101[0]). This powers up the ADC (if needed) after a programmable amount of time as determined by the SPI settle count registers (0x105, 0x106). If Bit 0 of the 0x101 register in the SPI is set, the ADC returns to standby mode after the capture is complete.

Fill Pin Timing

A fill of the FIFO can be initiated by asserting the differential FILL± pins. When a pulse is detected on the FILL± pins, the FIFO is filled.

Dump Pin Timing

A readback of the FIFO can be initiated by asserting the DUMP pin. When a logic high is detected on the DUMP pin, the FIFO data is available through the chosen interface.

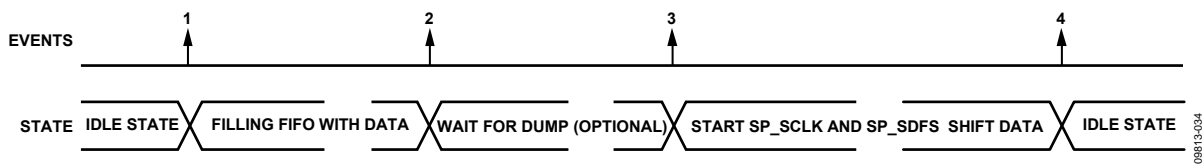

Figure 36. On-Chip FIFO Transaction Timing Assuming Serial Port

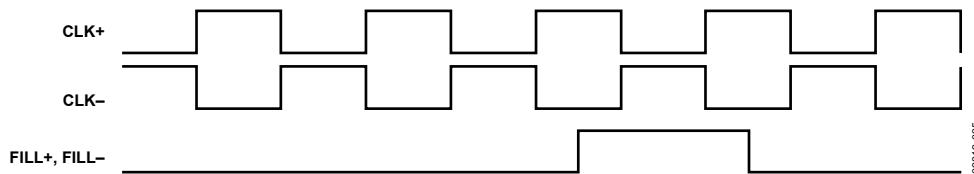

Figure 37. FIFO Fill Timing

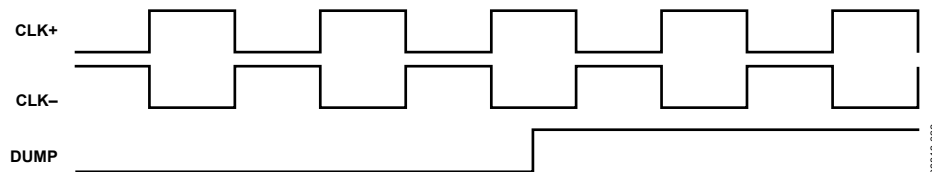

Figure 38. FIFO DUMP Timing

SPORT Master Mode (Single Capture)

Details of the transaction diagram for serial master mode are shown in Figure 39 for single capture mode with the SDO output. Clock cycles are approximate because the fill and dump signals can be driven asynchronously. In this example, SCLK is derived from the master clock with a divide by 8 programmed from the SPI.

Fill Pulse (1)

The FIFO captures data after a fill signal (high level) is detected on the rising edge of the sampling clock. In synchronous operation, a valid high level is accomplished by adhering to the setup and hold times specified. For nonsynchronous control, the fill signal can be widened to accommodate two or more clock cycles to guarantee capture of a high level. Fill count (0x104) is reset on the rising edge of the clock and is incremented on subsequent clock cycles only after the fill signal returns low. A new fill signal at any point during the capture resets the counter and begins filling the FIFO.

Empty Signal (2)

After the FIFO state machine has begun loading data, the empty signal goes low 24 clock cycles after the fill signal was last sampled high.

Full Signal (3)

The full signal indicates when the FIFO has been filled and is driven high when the number of samples specified has been captured in the FIFO, where

$$\text{Number of Samples} = (\text{FILL_CNT} + 1) \times 64$$

The time at which the full signal goes high is based on $(\text{FILL_CNT} + 1) \times 64 + 13$ clock cycles after the fill signal was last sampled high.

Dump Signal (4)—Transition to High

The dump signal initiates reading data from the FIFO. Dump is enabled with a high level and should be initiated only after the full signal goes high. The dump signal should be held high until all data has been read out of the FIFO.

SCLK Signal (5)

The SCLK (serial clock) signal is configured as an output from the device when in the master mode of operation. SCLK begins cycling five ADC clock cycles after the dump signal is sampled high and continues cycling up until one additional cycle after the empty signal goes high. SCLK then remains low until the next dump operation.

SDFS Signal (6)

The SDFS (serial data frame sync) signal is configured as an output from the device when in the master mode of operation. Frame synchronization begins 15 ADC clock cycles after the dump signal is sampled.

Dump Signal (7)—Transition to Low

A dump signal transition to low is applied after data has been read out of the FIFO.

Empty Signal (8)—Transition to High

The empty signal transitions to high after data has been output from the FIFO based on the clock cycle count of $(\text{FILL_CNT} + 1) \times 64$.

The transition occurs 76 ADC clock cycles after the last LSB(s) of data have been output on the serial port.

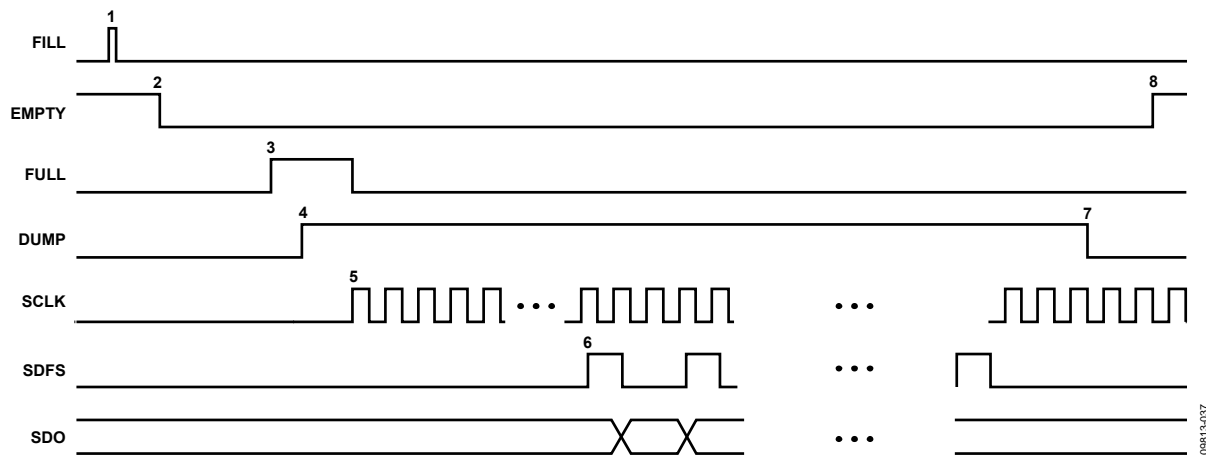

Figure 39. SPORT Master Mode Transaction Diagram

08813-037

Parallel Master Mode (Single Capture)

Details of the transaction diagram for parallel master mode are shown in Figure 40 with the PD[11:0] output word. Clock cycles are approximate because the fill and dump signals can be driven asynchronously. In this example, PCLK± is derived from the master clock with a divide by 8 programmed from the SPI.

Fill Pulse (1)

The FIFO captures data after a fill signal (high level) is detected on the rising edge of the sampling clock. In synchronous operation, a valid high level is accomplished by adhering to the setup and hold times specified. For nonsynchronous control, the fill signal can be widened to accommodate two or more clock cycles to guarantee capture of a high level. Fill count (0x104) is reset on the rising edge of the clock and is incremented on subsequent clock cycles only after the fill signal returns low. A new fill signal at any point during the capture resets the counter and begins filling the FIFO.

Empty Signal (2)

After the FIFO state machine has begun loading data, the empty signal goes low 24 clock cycles after the fill signal was last sampled high.

Full Signal (3)

The full signal indicates when the FIFO has been filled and is driven high when the number of samples specified has been captured in the FIFO, where

$$\text{Number of Samples} = (\text{FILL_CNT} + 1) \times 64$$

The time at which the full signal goes high is based on $(\text{FILL_CNT} + 1) \times 64 + 13$ clock cycles after the fill signal was last sampled high.

Dump Signal (4)—Transition to High

The dump signal initiates reading data from the FIFO. Dump is enabled with a high level and should be initiated only after the full signal goes high. The dump signal should be held high until all data has been read out of the FIFO.

PCLK± Signal (5)

The PCLK± (parallel clock) signal is configured as an output from the device. PCLK± begins cycling 71 ADC clock cycles after the dump signal is sampled high. PCLK± goes low after the last data is read out of the FIFO and remains low until the next dump operation.

PD[11:0] Signal (6)

The PD (parallel data) output provides 12 data bits (PD[11:0]) at a maximum rate of 1/8th of the sampling clock. Data begins after two PCLK± cycles (assuming the dump signal has been sampled).

Dump Signal (7)—Transition to Low

A dump signal transition to low is applied after data has been read out of the FIFO.

Empty Signal (8)—Transition to High

The empty signal transitions to high after data has been output from the FIFO based on the clock cycle count of $(\text{FILL_CNT} + 1) \times 64$. The transition occurs nine clock cycles after the last PCLK± rising edge.

Continuous Capture Mode

The FIFO can be placed into continuous capture mode by writing the FIFO fill mode bits in the fill control register (0x101[3:2]) to 01. In the continuous capture mode, data is loaded continuously into the FIFO and the FILL± pins pulsing high is used to stop the operation. This allows the history of the samples that preceded an event to be captured.

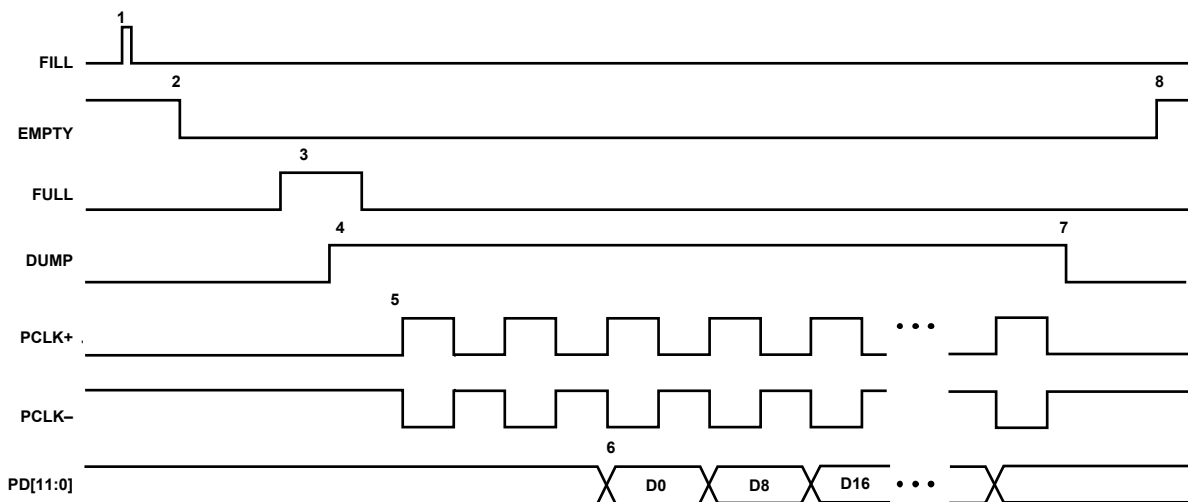

Figure 40. Parallel Mode Transaction Diagram

AD6641

FIFO OUTPUT INTERFACES

The FIFO data is available through one of three interfaces. The data can be output on the serial data port (SPORT), the SPI port, or a 12-bit CMOS interface. The data port chosen must be selected from the SPI port before the data is read from the FIFO. Only one interface can be chosen at a time. The SPORT and SPI interfaces are powered via the SPI_VDDIO pin and can support either 1.9 V or 3.3 V logic levels.

SPORT Interface

The SPORT consists of a clock (SP_SCLK) and frame sync (SP_SDFS) signal. The SP_SCLK and SP_SDFS signals are output from the AD6641 when the SPORT is configured as a bus master and are input to the device when it is configured as a slave port.

Serial Data Frame (Serial Bus Master)

The serial data transfer is initiated with SP_SDFS. In master mode, the internal serial controller initiates SP_SDFS after the dump input goes high requesting the data. SP_SDFS is valid for one complete clock cycle prior to the data shift. On the next clock cycle, the AD6641 begins shifting out the data stream.

CMOS Output Interface

The data stored in the FIFO can also be accessed via a 12-bit parallel CMOS interface. The maximum output throughput supported by the AD6641 is in the 12-bit CMOS mode and is internally limited to 1/8th of the maximum input sample rate. Therefore, the output maximum output data rate is 62.5 MHz

at a 500 MSPS input sample rate. See Figure 3 for the parallel CMOS mode output interface timing diagram.

LVDS Output Interface

The AD6641 differential outputs conform to the ANSI-644 LVDS standard on default power-up. This can be changed to a low power, reduced signal option similar to the IEEE 1596.3 standard using the SPI. This LVDS standard can further reduce the overall power dissipation of the device, which reduces the power by ~39 mW. The LVDS driver current is derived on chip and sets the output current at each output equal to a nominal 3.5 mA. A 100 Ω differential termination resistor placed at the LVDS receiver inputs results in a nominal ± 350 mV differential or 700 mV p-p swing at the receiver.

The AD6641 LVDS outputs facilitate interfacing with LVDS receivers in custom ASICs and FPGAs that have LVDS capability for superior switching performance in noisy environments. Single point-to-point net topologies are recommended with a 100 Ω termination resistor placed as close to the receiver as possible. No far-end receiver termination and poor differential trace routing may result in timing errors. It is recommended that the trace length be no longer than 24 inches and that the differential output traces be kept close together and at equal lengths.

The data on the LVDS output port is interleaved in a MSB/LSB format. PCLK \pm is generated by dividing the ADC sample clock by the programmed decimation rate (8 to 32, even divides). The maximum rate of PCLK \pm is limited to 62.5 MHz.

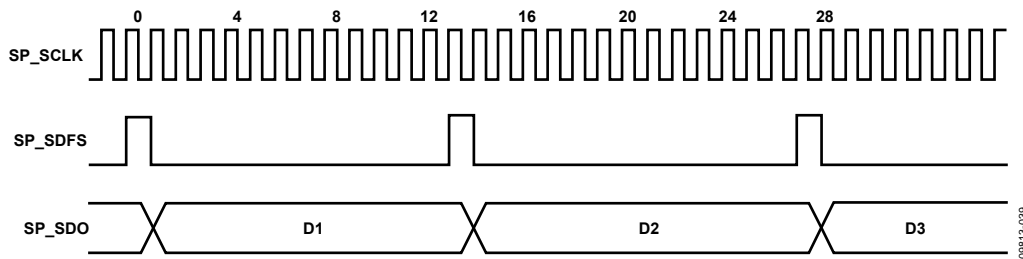

Figure 41. Data Output in Serial Bus Master Mode

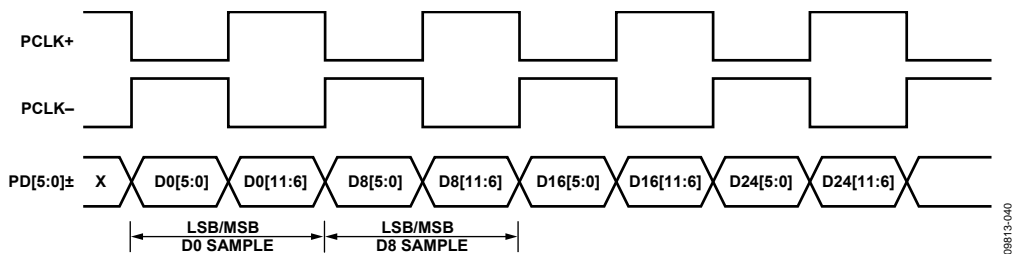

Figure 42. DDR LVDS Output MSB/LSB Interleaving with Decimate by 8

ANALOG INPUT AND VOLTAGE REFERENCE

The analog input to the AD6641 is a differential buffer. For best dynamic performance, match the source impedances driving VIN+ and VIN– such that common-mode settling errors are symmetrical. The analog input is optimized to provide superior wideband performance and requires that the analog inputs be driven differentially. SNR and SINAD performance degrades significantly if the analog input is driven with a single-ended signal.

A wideband transformer, such as Mini-Circuits® ADT1-1WT, can provide the differential analog inputs for applications that require a single-ended-to-differential conversion. Both analog inputs are self-biased by an on-chip reference to a nominal 1.7 V.

An internal differential voltage reference creates positive and negative reference voltages that define the 1.5 V p-p fixed span of the ADC core. This internal voltage reference can be adjusted by means of an SPI control.

VREF

The AD6641 VREF pin (Pin 31) allows the user to monitor the on-board voltage reference or provide an external reference (requires configuration through the SPI). The three optional settings are internal V_{REF} (pin is connected to 20 k Ω to ground), export V_{REF} , and import V_{REF} . Do not attach a bypass capacitor to this pin. VREF is internally compensated and additional loading may impact performance.

CONFIGURATION USING THE SPI

Three pins define the SPI of the AD6641: SCLK, SDIO, and CSB (see Table 11). SCLK (a serial clock) is used to synchronize the read and write data presented from and to the AD6641. SDIO (serial data input/output) is a bidirectional pin that allows data to be sent to and read from the internal memory map registers. CSB (chip select) is an active low control that enables or disables the read and write cycles.

Table 11. Serial Port Interface Pins

Pin	Function
SCLK	Serial clock. Serial shift clock input. SCLK is used to synchronize serial interface reads and writes.
SDIO	Serial data input/output. Bidirectional pin that serves as an input or an output, depending on the instruction being sent and the relative position in the timing frame.
CSB	Chip select (active low). This control gates the read and write cycles.

The falling edge of the CSB pin, in conjunction with the rising edge of the SCLK pin, determines the start of the framing. An example of the serial timing can be found in Figure 43 (for symbol definitions, see Table 5).

CSB can be held low indefinitely, which permanently enables the device; this is called streaming. CSB can stall high between bytes to allow additional external timing. When CSB is tied high, SPI functions are placed in high impedance mode.

During an instruction phase, a 16-bit instruction is transmitted. The first bit of the first byte in a serial data transfer frame indicates whether a read command or a write command is issued. Data follows the instruction phase, and its length is determined by the W0 and W1 bits. All data is composed of 8-bit words.

The instruction phase determines whether the serial frame is a read or write operation, allowing the serial port to be used both to program the chip and to read the contents of the on-chip memory. If the instruction is a read operation, the serial data input/output (SDIO) pin changes direction from an input to an output at the appropriate point in the serial frame.

Data can be sent in MSB first mode or in LSB first mode. MSB first is the default mode on power-up and can be changed via the SPI port configuration register. For more information about this and other features, see the [AN-877](#) Application Note, *Interfacing to High Speed ADCs via SPI*.

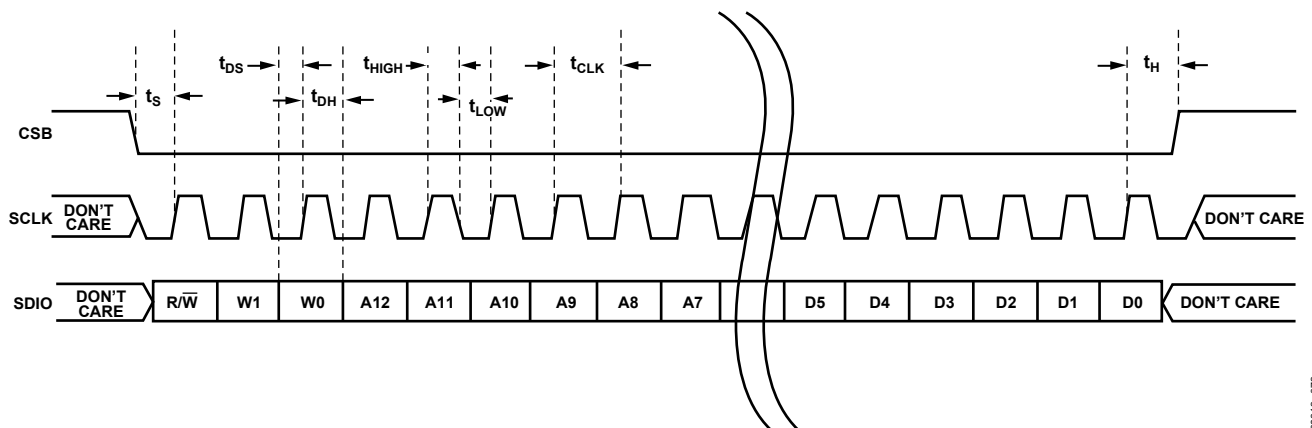
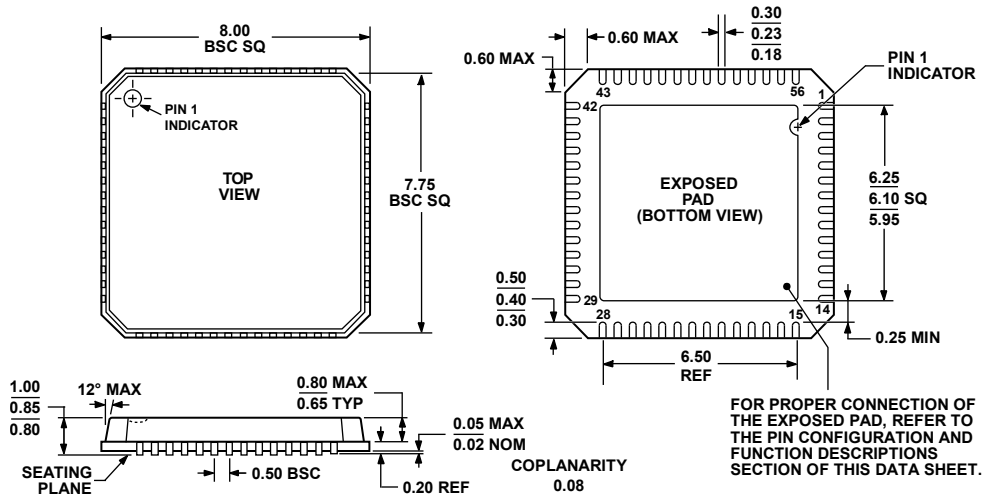

Figure 43. Serial Port Interface Timing Diagram

OUTLINE DIMENSIONS



COMPLIANT TO JEDEC STANDARDS MO-220-VLLD-2

Figure 44. 56-Lead Lead Frame Chip Scale Package [LFCSP_VQ]
 8 mm × 8 mm Body, Very Thin Quad
 (CP-56-1)
 Dimensions shown in millimeters

030809A

ORDERING GUIDE

Model ¹	Temperature Range	Package Description	Package Option
AD6641BCPZ-500	-40°C to +85°C	56-Lead Lead Frame Chip Scale Package [LFCSP_VQ]	CP-56-1
AD6641BCPZRL7-500	-40°C to +85°C	56-Lead Lead Frame Chip Scale Package [LFCSP_VQ], 7" Tape and Reel	CP-56-1
AD6641-500EBZ		Evaluation Board	

¹ Z = RoHS Compliant Part.



Стандарт Электрон Связь

Мы молодая и активно развивающаяся компания в области поставок электронных компонентов. Мы поставляем электронные компоненты отечественного и импортного производства напрямую от производителей и с крупнейших складов мира.

Благодаря сотрудничеству с мировыми поставщиками мы осуществляем комплексные и плановые поставки широчайшего спектра электронных компонентов.

Собственная эффективная логистика и склад в обеспечивает надежную поставку продукции в точно указанные сроки по всей России.

Мы осуществляем техническую поддержку нашим клиентам и предпродажную проверку качества продукции. На все поставляемые продукты мы предоставляем гарантию .

Осуществляем поставки продукции под контролем ВП МО РФ на предприятия военно-промышленного комплекса России , а также работаем в рамках 275 ФЗ с открытием отдельных счетов в уполномоченном банке. Система менеджмента качества компании соответствует требованиям ГОСТ ISO 9001.

Минимальные сроки поставки, гибкие цены, неограниченный ассортимент и индивидуальный подход к клиентам являются основой для выстраивания долгосрочного и эффективного сотрудничества с предприятиями радиоэлектронной промышленности, предприятиями ВПК и научно-исследовательскими институтами России.

С нами вы становитесь еще успешнее!

Наши контакты:

Телефон: +7 812 627 14 35

Электронная почта: sales@st-electron.ru

Адрес: 198099, Санкт-Петербург,
Промышленная ул, дом № 19, литера Н,
помещение 100-Н Офис 331