

# HLMP-EGxx, HLMP-EHxx, HLMP-ELxx

## New T-1 $\frac{3}{4}$ (5mm) Extra High Brightness AllnGaP LED Lamps



## Data Sheet



### Description

These Precision Optical Performance AllnGaP LEDs provide superior light output for excellent readability in sunlight and are extremely reliable. AllnGaP LED technology provides extremely stable light output over long periods of time. Precision Optical Performance lamps utilize the aluminum indium gallium phosphide (AllnGaP) technology.

These LED lamps are untinted, T-1 $\frac{3}{4}$  packages incorporating second generation optics producing well defined spatial radiation patterns at specific viewing cone angles.

These lamps are made with an advanced optical grade epoxy offering superior high temperature and high moisture resistance performance in outdoor signal and sign application. The maximum LED junction temperature limit of +130°C enables high temperature operation in bright sunlight conditions. The epoxy contains both uv-a and uv-b inhibitors to reduce the effects of long term exposure to direct sunlight.

### Benefits

- Superior performance for outdoor environments
- Suitable for auto-insertion onto PC board

### Features

- Viewing angle: 15°, 23°, 30°
- High luminous output
- Colors:
  - 590nm Amber
  - 615nm Red Orange
  - 626nm Red
- Package options:
  - With or without lead standoff
- Superior resistance to moisture
- Untinted for 15°, 23° and 30° lamps

### Applications

- Traffic management:
  - Traffic signals
  - Pedestrian signals
  - Work zone warning lights
  - Variable message signs
- Solar Power signs
- Commercial outdoor advertising
  - Signs
  - Marquees

# Package Dimension

## A: Non-standoff

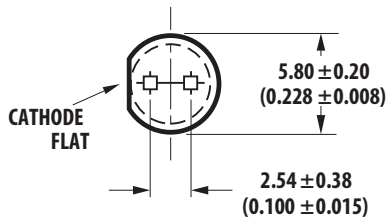
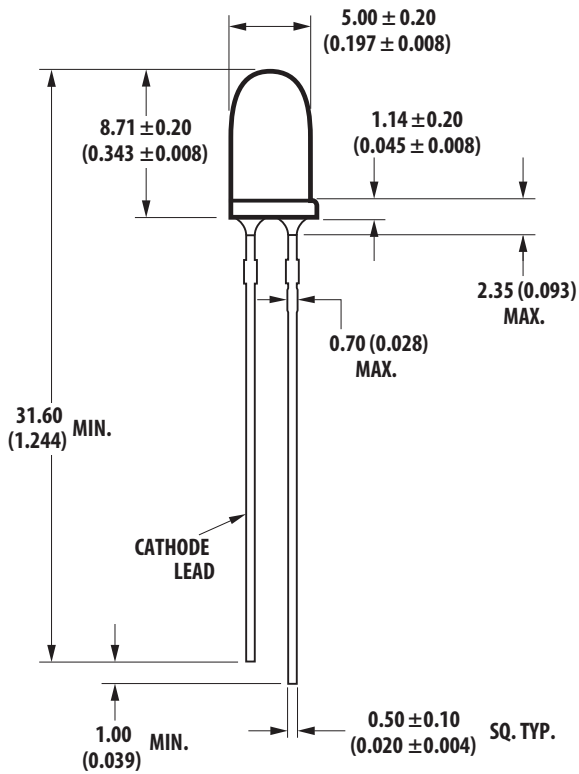

## B: Standoff

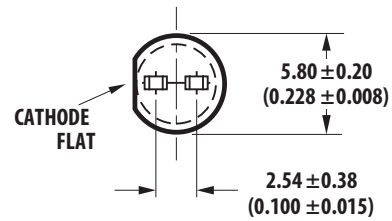
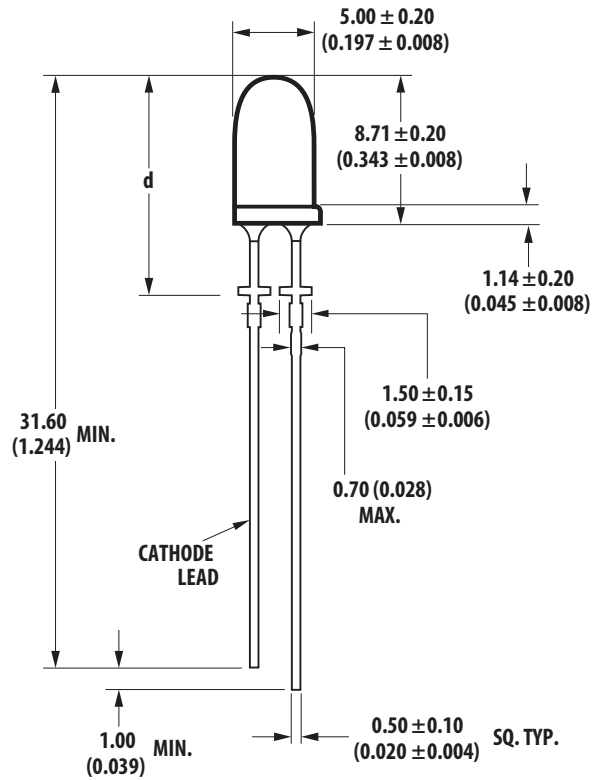

Viewing Angle	d
15°	12.39±0.25 (0.476±0.010)
23° & 30°	11.96±0.25 (0.459±0.010)

### Notes:

1. All dimensions are in millimeters (inches)
2. Leads are mild steel with tin plating.
3. The epoxy meniscus is 1.21mm max
4. For Identification of polarity after the leads are trimmed off, please refer to the illustration below:

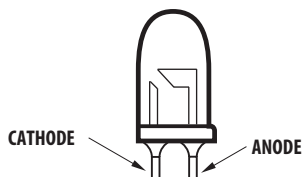

## Device Selection Guide

Typical viewing Angle $2\theta_{1/2}$ (Deg) <sup>[4]</sup>	Color and Dominant Wavelength (nm), Typ <sup>[3]</sup>	Lamps without Standoff on leads (Package drawing A)	Lamps with Standoff on leads (Package drawing B)	Luminous Intensity Iv (mcd) <sup>[1,2,5]</sup> at 20 mA		
				Min	Max	
15°	Amber 590	HLMP-EL1A-Z1KDD	HLMP-EL1B-Z1KDD	12000	21000	
		HLMP-EL1A-Z1LDD	HLMP-EL1B-Z1LDD	12000	21000	
	Red 626	HLMP-EG1A-Z10DD	HLMP-EG1B-Z10DD	12000	21000	
	Red Orange 615	HLMP-EH1A-Z10DD	HLMP-EH1B-Z10DD	12000	21000	
23°	Amber 590	HLMP-EL2A-XYKDD	HLMP-EL2B-XYKDD	7200	12000	
		HLMP-EL2A-XYLDD	HLMP-EL2B-XYLDD	7200	12000	
	Red 626	HLMP-EG2A-XY0DD	HLMP-EG2B-XY0DD	7200	12000	
	Red Orange 615	HLMP-EH2A-XY0DD	HLMP-EH2B-XY0DD	7200	12000	
30°	Amber 590	HLMP-EL3A-VWKDD	HLMP-EL3B-VWKDD	4200	7200	
		HLMP-EL3A-VWLDD	HLMP-EL3B-VWLDD	4200	7200	
		HLMP-EL3A-WXKDD	HLMP-EL3B-WXKDD	5500	9300	
		HLMP-EL3A-WXLDD	HLMP-EL3B-WXLDD	5500	9300	
	Red 626	HLMP-EG3A-VW0DD	HLMP-EG3B-VW0DD	4200	7200	
		HLMP-EG3A-WX0DD	HLMP-EG3B-WX0DD	5500	9300	
		Red Orange 615	HLMP-EH3A-WX0DD	HLMP-EH3B-WX0DD	5500	9300

### Notes:

1. The luminous intensity is measured on the mechanical axis of the lamp package and it is tested with pulsing condition.
2. The optical axis is closely aligned with the package mechanical axis.
3. Dominant wavelength,  $\lambda_d$ , is derived from the CIE Chromaticity Diagram and represents the color of the lamp.
4.  $\theta_{1/2}$  is the off-axis angle where the luminous intensity is half the on-axis intensity.
5. Tolerance for each bin limit is  $\pm 15\%$

## Part Numbering System

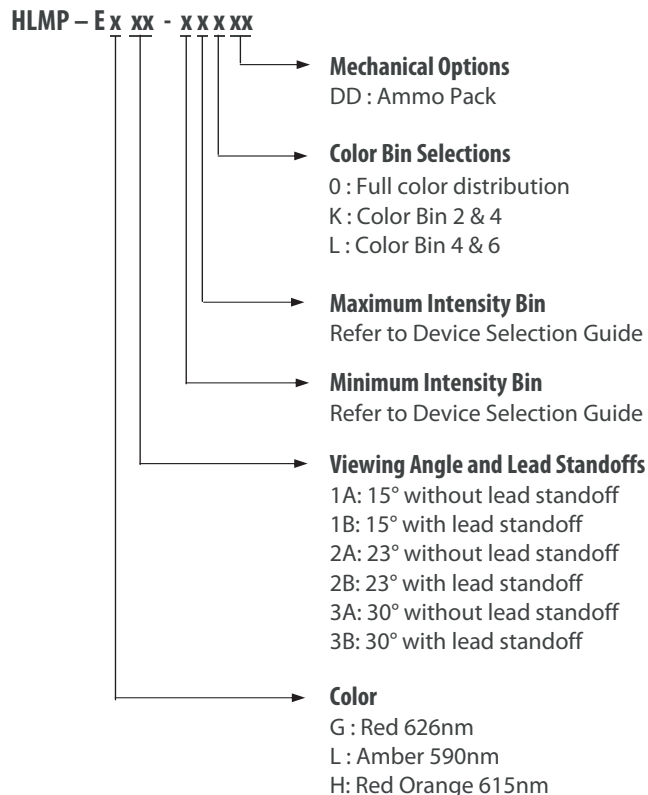

Note: Please refer to AB 5337 for complete information on part numbering system.

## Absolute Maximum Ratings

T<sub>J</sub> = 25°C

Parameter	Red/ Amber/ Red Orange	Unit
DC Forward Current [2]	50	mA
Peak Forward Current	100 [1]	mA
Average forward current	30	mA
Power Dissipation	120	mW
Reverse Voltage	5	V
Operating Temperature Range	-40 to +100	°C
Storage Temperature Range	-40 to +100	°C

Notes:

1. Duty Factor 30%, frequency 1KHz.
2. Derate linearly as shown in Figure 4

## Electrical / Optical Characteristics

T<sub>J</sub> = 25°C

Parameter	Symbol	Min	Typ.	Max	Units	Test Conditions
Forward Voltage Amber/ Red / Red Orange	V <sub>F</sub>	1.8	2.1	2.4	V	I <sub>F</sub> = 20 mA
Reverse Voltage	V <sub>R</sub>	5			V	I <sub>R</sub> = 100 μA
Dominant Wavelength [1] Amber Red Red Orange	λ <sub>d</sub>	584.5 618.0 612.0	590.0 626.0 615.0	594.5 630.0 619.0	nm	I <sub>F</sub> = 20 mA
Peak Wavelength Amber Red Red Orange	λ <sub>PEAK</sub>		594 634 621		nm	Peak of Wavelength of Spectral Distribution at I <sub>F</sub> = 20 mA
Spectral Halfwidth Amber Red Red Orange	Δλ <sub>1/2</sub>		13 14 14		nm	
Thermal resistance	Rθ <sub>J-PIN</sub>		240		°C/W	LED junction to anode lead
Luminous Efficacy [2] Amber Red Red Orange	η <sub>v</sub>		500 200 265		lm/W	Emitted Luminous Flux/ Emitted Radiant Flux
Luminous Flux Amber Red Red Orange	Φ <sub>v</sub>		2100 2300 2300		mlm	I <sub>F</sub> = 20 mA
Luminous Efficiency [3] Amber Red Red Orange	η <sub>e</sub>		50 55 55		lm/W	Emitted Luminous Flux/Electrical Power
Thermal coefficient of λ <sub>d</sub> Amber Red Red Orange			0.08 0.05 0.07		nm/°C	I <sub>F</sub> = 20 mA ; +25°C ≤ T <sub>J</sub> ≤ +100°C

Notes:

1. The dominant wavelength, λ<sub>d</sub> is derived from the CIE Chromaticity Diagram referenced to Illuminant E. Tolerance for each color of dominant wavelength is +/- 0.5nm.
2. The radiant intensity, I<sub>e</sub> in watts per steradian, maybe found from the equation I<sub>e</sub> = I<sub>v</sub> / η<sub>v</sub> where I<sub>v</sub> is the luminous intensity in candela and η<sub>v</sub> is the luminous efficacy in lumens/ watt.
3. η<sub>e</sub> = Φ<sub>v</sub> / I<sub>F</sub> × V<sub>F</sub> where Φ<sub>v</sub> is the emitted luminous flux, I<sub>F</sub> is electrical forward current and V<sub>F</sub> is the forward voltage.

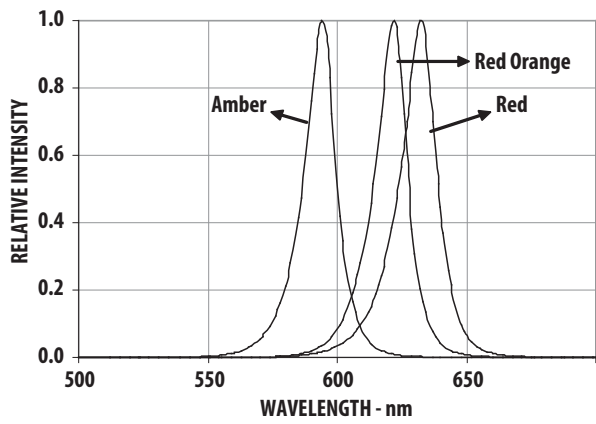

Figure 1. Relative Intensity vs Peak Wavelength

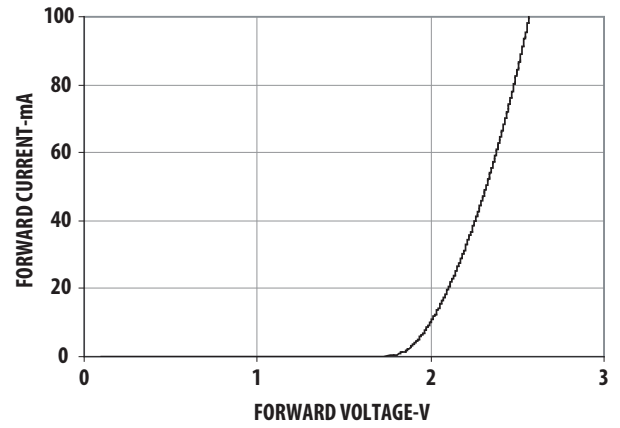

Figure 2. Forward Current vs Forward Voltage

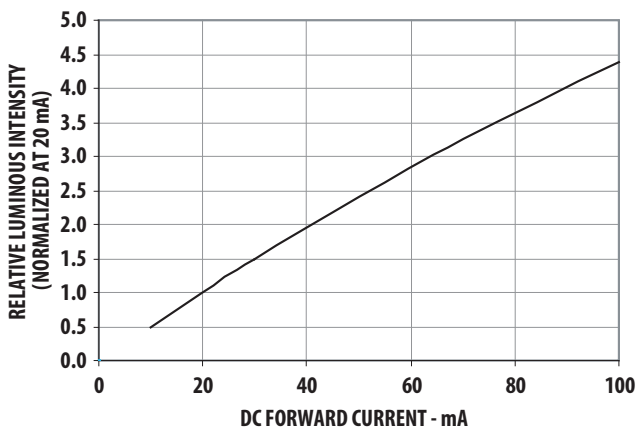

Figure 3. Relative Luminous Intensity vs Forward Current

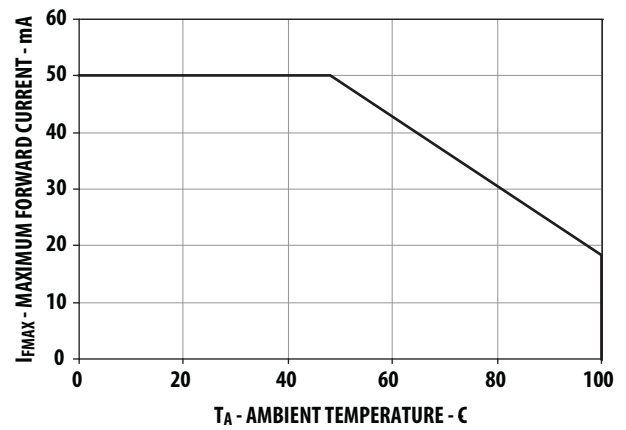

Figure 4. Maximum Forward Current vs Ambient Temperature

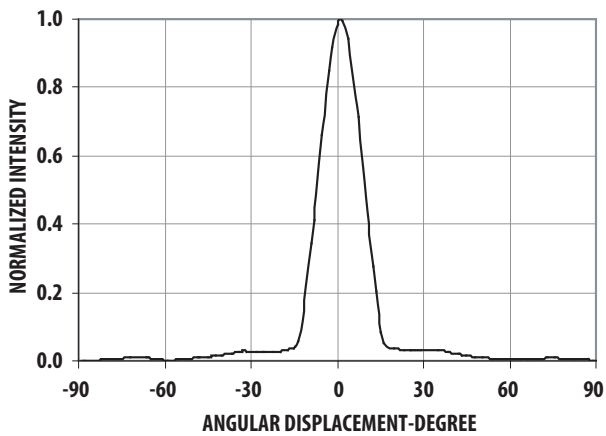

Figure 5. Radiation Pattern for 15° Viewing Angle Lamp

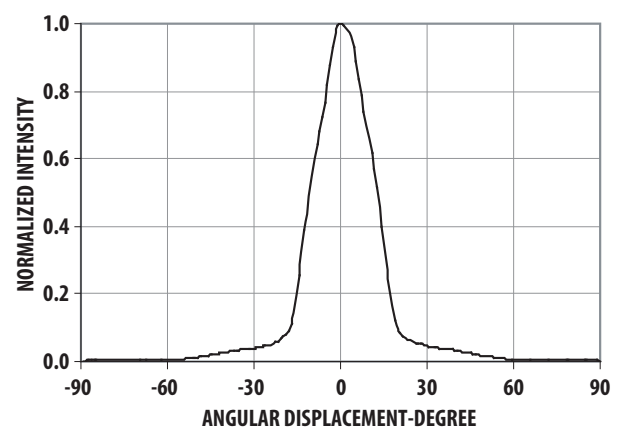

Figure 6. Radiation Pattern for 23° Viewing Angle Lamp

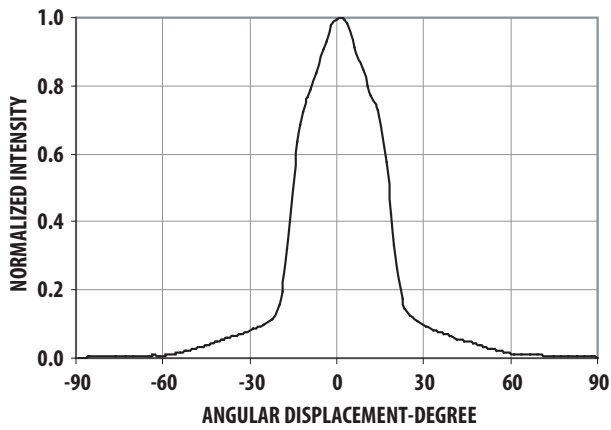
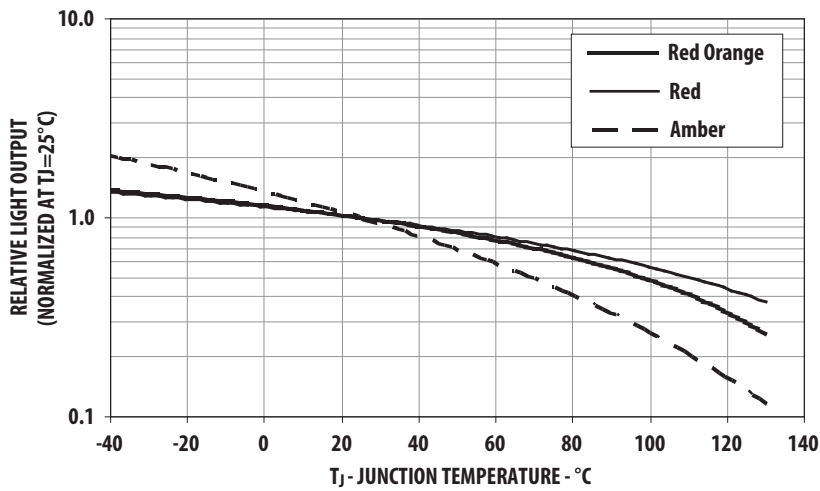
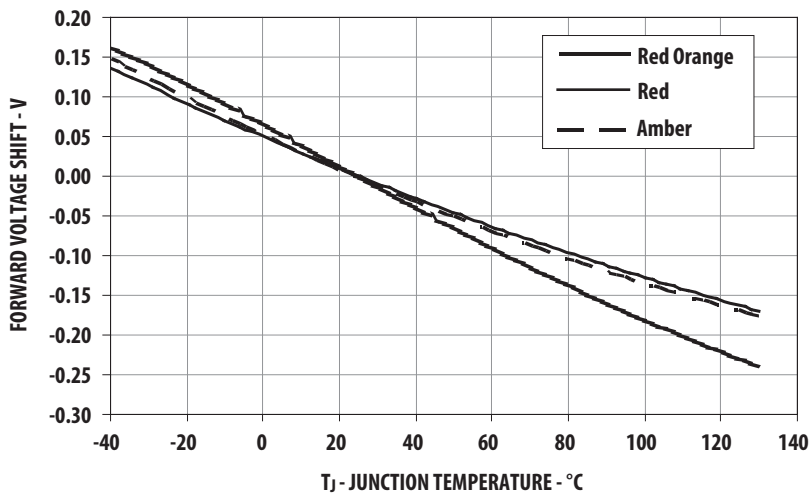

Figure 7. Radiation Pattern for 30° Viewing Angle Lamp

### Relative Light Output vs Junction Temperature



### Relative Forward Voltage vs Junction Temperature



### Intensity Bin Limit Table (1.3:1 Iv bin ratio)

Bin	Intensity (mcd) at 20mA	
	Min	Max
V	4200	5500
W	5500	7200
X	7200	9300
Y	9300	12000
Z	12000	16000
1	16000	21000

Tolerance for each bin limit is  $\pm 15\%$

### VF Bin Table (V at 20mA)

Bin ID	Min	Max
VD	1.8	2.0
VA	2.0	2.2
VB	2.2	2.4

Tolerance for each bin limit is  $\pm 0.05V$

### Red Color Range

Min Dom	Max Dom	X min	Y Min	X max	Y max
618	630	0.6872	0.3126	0.6890	0.2943
		0.6690	0.3149	0.7080	0.2920

Tolerance for each bin limit is  $\pm 0.5nm$

### Amber Color Range

Bin	Min Dom	Max Dom	Xmin	Ymin	Xmax	Ymax
2	587	589.5	0.5570	0.4420	0.5670	0.4250
			0.5530	0.4400	0.5720	0.4270
4	589.5	592	0.5720	0.4270	0.5820	0.4110
			0.5670	0.4250	0.5870	0.4130
6	592	594.5	0.5870	0.4130	0.5950	0.3980
			0.5820	0.4110	0.6000	0.3990

Tolerance for each bin limit is  $\pm 0.5nm$

### Red Orange Color Range

Min Dom	Max Dom	Xmin	Ymin	Xmax	Ymax
612	619	0.6712	0.6887	0.6716	0.6549
		0.3280	0.3109	0.3116	0.3282

Tolerance for each bin limit  $\pm 0.5nm$

Note:

All bin categories are established for classification of products. Products may not be available in all bin categories. Please contact Avago representative for further information.

### Avago Color Bin on CIE 1931 Chromaticity Diagram

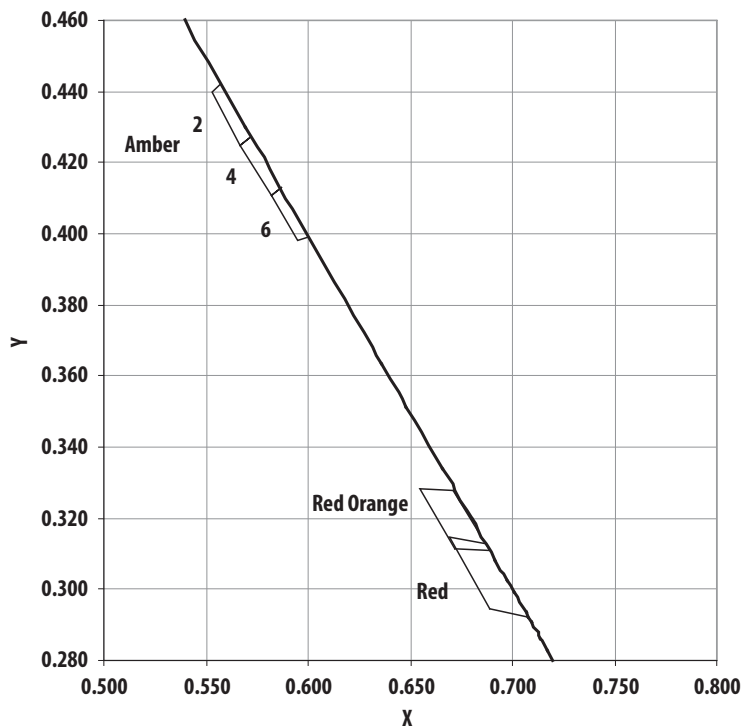

## Precautions:

### Lead Forming:

- The leads of an LED lamp may be preformed or cut to length prior to insertion and soldering on PC board.
- For better control, it is recommended to use proper tool to precisely form and cut the leads to applicable length rather than doing it manually.
- If manual lead cutting is necessary, cut the leads after the soldering process. The solder connection forms a mechanical ground which prevents mechanical stress due to lead cutting from traveling into LED package. This is highly recommended for hand solder operation, as the excess lead length also acts as small heat sink.

### Soldering and Handling:

- Care must be taken during PCB assembly and soldering process to prevent damage to the LED component.
- LED component may be effectively hand soldered to PCB. However, it is only recommended under unavoidable circumstances such as rework. The closest manual soldering distance of the soldering heat source (soldering iron's tip) to the body is 1.59mm. Soldering the LED using soldering iron tip closer than 1.59mm might damage the LED.

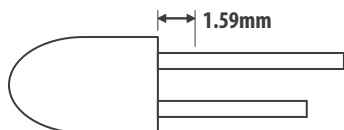

- ESD precaution must be properly applied on the soldering station and personnel to prevent ESD damage to the LED component that is ESD sensitive. Do refer to Avago application note AN 1142 for details. The soldering iron used should have grounded tip to ensure electrostatic charge is properly grounded.
- Recommended soldering condition:

	Wave Soldering [1, 2]	Manual Solder Dipping
Pre-heat temperature	105 °C Max.	-
Preheat time	60 sec Max	-
Peak temperature	260 °C Max.	260 °C Max.
Dwell time	5 sec Max.	5 sec Max

#### Note:

- 1) Above conditions refers to measurement with thermocouple mounted at the bottom of PCB.
  - 2) It is recommended to use only bottom preheaters in order to reduce thermal stress experienced by LED.
- Wave soldering parameters must be set and maintained according to the recommended temperature and dwell time. Customer is advised to perform daily check on the soldering profile to ensure that it is always conforming to recommended soldering conditions.

#### Note:

1. PCB with different size and design (component density) will have different heat mass (heat capacity). This might cause a change in temperature experienced by the board if same wave soldering setting is used. So, it is recommended to re-calibrate the soldering profile again before loading a new type of PCB.
2. Avago Technologies' high brightness LED are using high efficiency LED die with single wire bond as shown below. Customer is advised to take extra precaution during wave soldering to ensure that the maximum wave temperature does not exceed 260°C and the solder contact time does not exceeding 5sec. Over-stressing the LED during soldering process might cause premature failure to the LED due to delamination.

### Avago Technologies LED Configuration

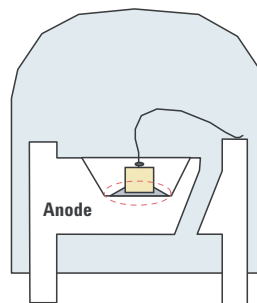

Note: Electrical connection between bottom surface of LED die and the lead frame is achieved through conductive paste.

- Any alignment fixture that is being applied during wave soldering should be loosely fitted and should not apply weight or force on LED. Non metal material is recommended as it will absorb less heat during wave soldering process.

Note: In order to further assist customer in designing jig accurately that fit Avago Technologies' product, 3D model of the product is available upon request.

- At elevated temperature, LED is more susceptible to mechanical stress. Therefore, PCB must allowed to cool down to room temperature prior to handling, which includes removal of alignment fixture or pallet.
- If PCB board contains both through hole (TH) LED and other surface mount components, it is recommended that surface mount components be soldered on the top side of the PCB. If surface mount need to be on the bottom side, these components should be soldered using reflow soldering prior to insertion the TH LED.
- Recommended PC board plated through holes (PTH) size for LED component leads.

LED component lead size	Diagonal	Plated through hole diameter
0.45 x 0.45 mm (0.018x 0.018 inch)	0.636 mm (0.025 inch)	0.98 to 1.08 mm (0.039 to 0.043 inch)
0.50 x 0.50 mm (0.020x 0.020 inch)	0.707 mm (0.028 inch)	1.05 to 1.15 mm (0.041 to 0.045 inch)

- Over-sizing the PTH can lead to twisted LED after clinching. On the other hand under sizing the PTH can cause difficulty inserting the TH LED.



Refer to application note AN5334 for more information about soldering and handling of high brightness TH LED lamps.

### Example of Wave Soldering Temperature Profile for TH LED

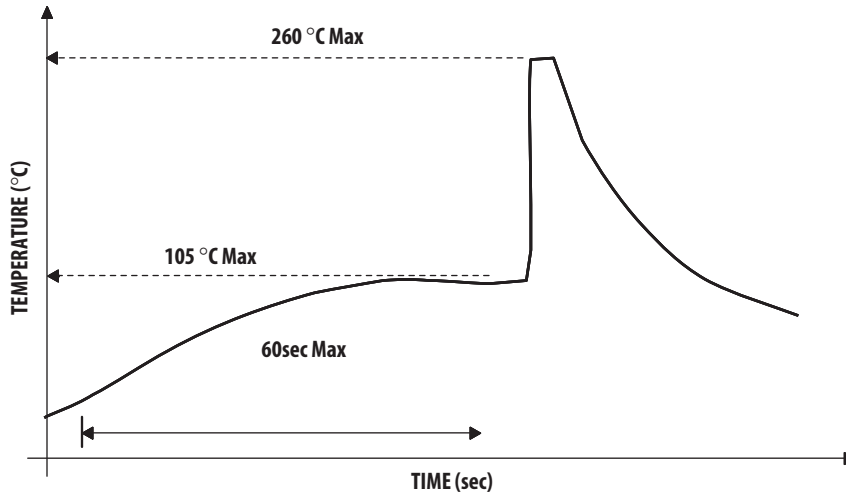

Recommended solder:  
 Sn63 (Leaded solder alloy)  
 SAC305 (Lead free solder alloy)

Flux: Rosin flux

Solder bath temperature:  $255^{\circ}\text{C} \pm 5^{\circ}\text{C}$   
 (maximum peak temperature =  $260^{\circ}\text{C}$ )

Dwell time: 3.0 sec - 5.0 sec  
 (maximum = 5sec)

Note: Allow for board to be sufficiently cooled to room temperature before exerting mechanical force.

### Ammo Packs Drawing

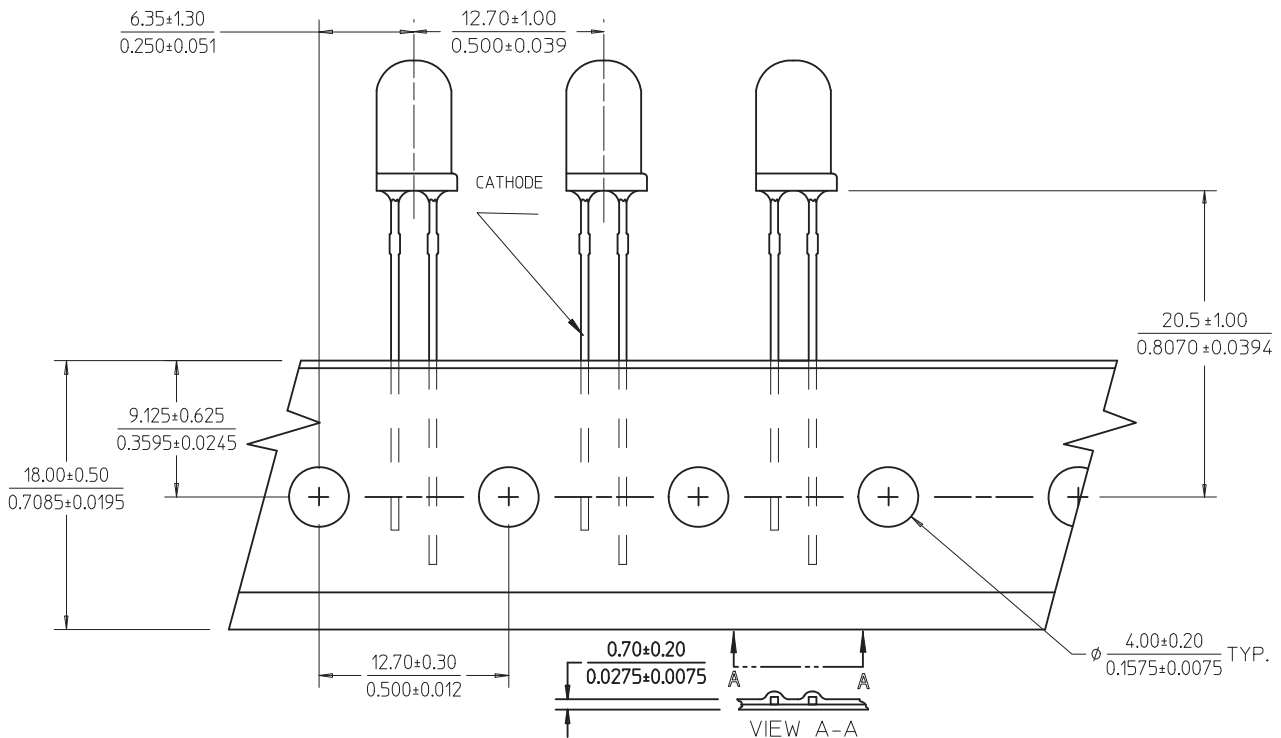

Note: The ammo-packs drawing is applicable for packaging option -DD & -ZZ and regardless standoff or non-standoff

## Packaging Box for Ammo Packs



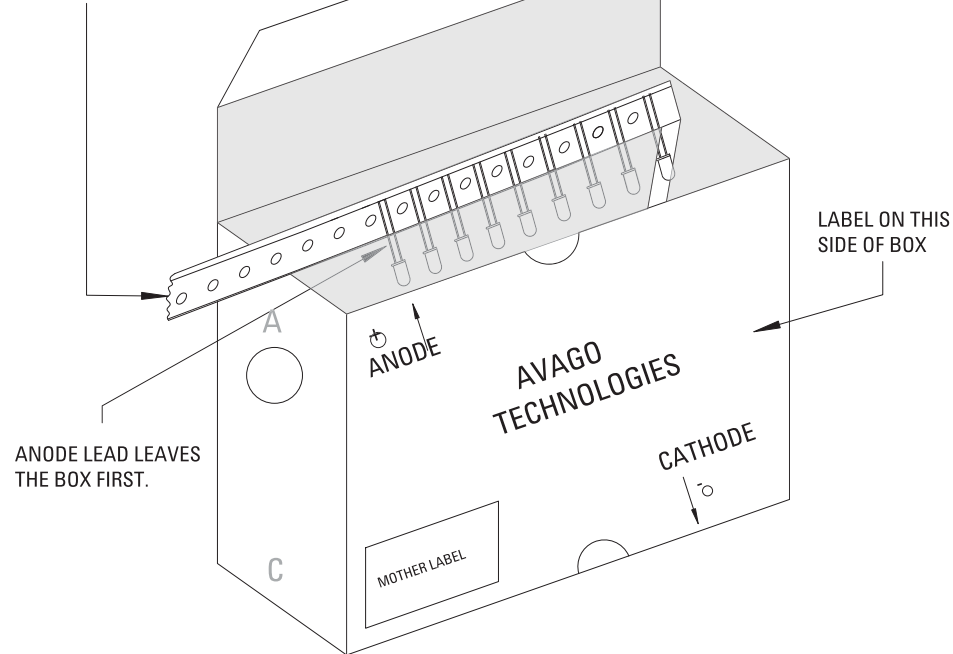









FROM LEFT SIDE OF BOX  
ADHESIVE TAPE MUST BE  
FACING UPWARDS.













Note: The dimension for ammo pack is applicable for the device with standoff and without standoff.

## Packaging Label:

(i) Avago Mother Label: (Available on packaging box of ammo pack and shipping box)

 <b>AVAGO</b> TECHNOLOGIES	
(1P) Item: <b>Part Number</b>	STANDARD LABEL LS0002
	RoHS Compliant
(1T) Lot: <b>Lot Number</b>	e3 max temp 260C
	(Q) QTY: <b>Quantity</b>
LPN:	
	CAT: <b>Intensity Bin</b>
(9D)MFG Date: <b>Manufacturing Date</b>	
	BIN: <b>Refer to below information</b>
<hr/>	
(P) Customer Item:	
	
(V) Vendor ID:	(9D) Date Code: <b>Date Code</b>
	
<hr/>	
DeptID:	Made In: <b>Country of Origin</b>
	

(ii) Avago Baby Label (Only available on bulk packaging)

		RoHS Compliant e3 max temp 260C
<b>Lamps Baby Label</b>		
(1P) PART #: Part Number		
		
(1T) LOT #: Lot Number		
		
(9D)MFG DATE: Manufacturing Date	QUANTITY: Packing Quantity	
		
C/O: Country of Origin		
Customer P/N:	CAT: Intensity Bin	
		
Supplier Code:	BIN: Refer to below information	
		
	DATECODE: Date Code	
		

**Acronyms and Definition:**

BIN:

(i) Color bin only or VF bin only

(Applicable for part number with color bins but without VF bin OR part number with VF bins and no color bin)

OR

(ii) Color bin incorporated with VF Bin

(Applicable for part number that have both color bin and VF bin)

Example:

(i) Color bin only or VF bin only

BIN: 2 (represent color bin 2 only)

BIN: VB (represent VF bin "VB" only)

(ii) Color bin incorporate with VF Bin



**DISCLAIMER:** AVAGO'S PRODUCTS AND SOFTWARE ARE NOT SPECIFICALLY DESIGNED, MANUFACTURED OR AUTHORIZED FOR SALE AS PARTS, COMPONENTS OR ASSEMBLIES FOR THE PLANNING, CONSTRUCTION, MAINTENANCE OR DIRECT OPERATION OF A NUCLEAR FACILITY OR FOR USE IN MEDICAL DEVICES OR APPLICATIONS. CUSTOMER IS SOLELY RESPONSIBLE, AND WAIVES ALL RIGHTS TO MAKE CLAIMS AGAINST AVAGO OR ITS SUPPLIERS, FOR ALL LOSS, DAMAGE, EXPENSE OR LIABILITY IN CONNECTION WITH SUCH USE.

For product information and a complete list of distributors, please go to our web site: [www.avagotech.com](http://www.avagotech.com)

Avago, Avago Technologies, and the A logo are trademarks of Avago Technologies in the United States and other countries. Data subject to change. Copyright © 2005-2010 Avago Technologies. All rights reserved. AV02-1687EN - February 23, 2010





## Стандарт Электрон Связь

Мы молодая и активно развивающаяся компания в области поставок электронных компонентов. Мы поставляем электронные компоненты отечественного и импортного производства напрямую от производителей и с крупнейших складов мира.

Благодаря сотрудничеству с мировыми поставщиками мы осуществляем комплексные и плановые поставки широчайшего спектра электронных компонентов.

Собственная эффективная логистика и склад в обеспечивает надежную поставку продукции в точно указанные сроки по всей России.

Мы осуществляем техническую поддержку нашим клиентам и предпродажную проверку качества продукции. На все поставляемые продукты мы предоставляем гарантию .

Осуществляем поставки продукции под контролем ВП МО РФ на предприятия военно-промышленного комплекса России , а также работаем в рамках 275 ФЗ с открытием отдельных счетов в уполномоченном банке. Система менеджмента качества компании соответствует требованиям ГОСТ ISO 9001.

Минимальные сроки поставки, гибкие цены, неограниченный ассортимент и индивидуальный подход к клиентам являются основой для выстраивания долгосрочного и эффективного сотрудничества с предприятиями радиоэлектронной промышленности, предприятиями ВПК и научно-исследовательскими институтами России.

С нами вы становитесь еще успешнее!

### Наши контакты:

**Телефон:** +7 812 627 14 35

**Электронная почта:** [sales@st-electron.ru](mailto:sales@st-electron.ru)

**Адрес:** 198099, Санкт-Петербург,  
Промышленная ул, дом № 19, литера Н,  
помещение 100-Н Офис 331