

STRADELLA-CY

Beam for canopy lighting with batwing light distribution. Suitable for symmetrical tunnel lighting.

TECHNICAL SPECIFICATIONS:

Dimensions	13.9 mm
Height	4.7 mm
Fastening	pin
ROHS compliant	yes ⓘ

MATERIAL SPECIFICATIONS:

Component	Type	Material	Colour	Finish
STRADELLA-CY	Single lens	PMMA	clear	

ORDERING INFORMATION:

Component	Qty in box	MOQ	MPQ	Box weight (kg)
C15437_STRADELLA-CY » Box size: 480 x 250 x 390 mm	16000	1000	1000	7.3

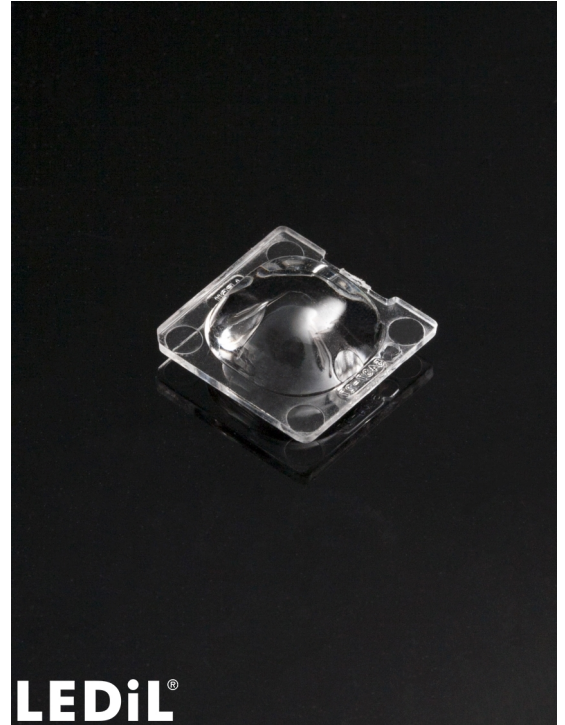

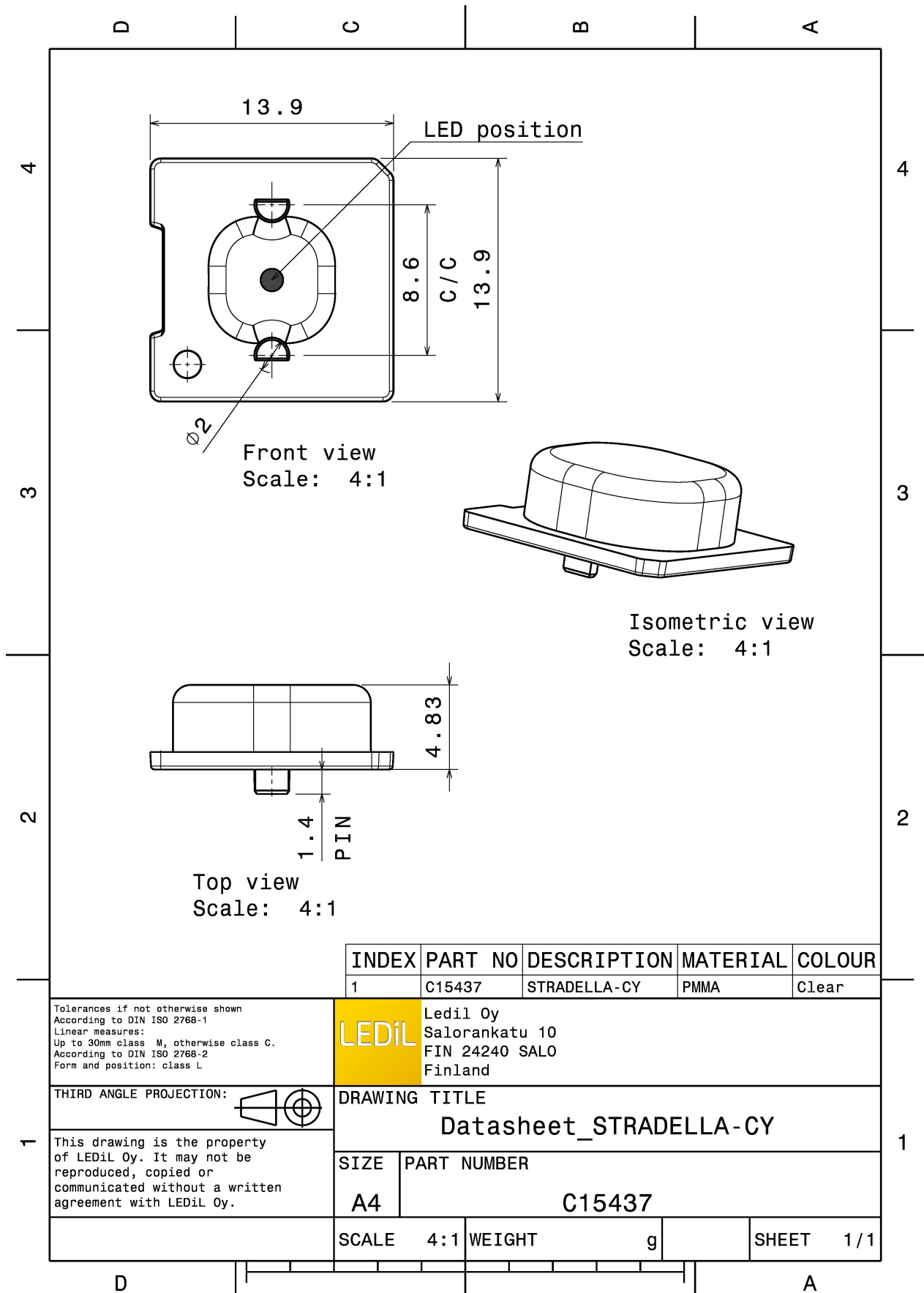

PHOTOMETRIC DATA (MEASURED):

CREE

LED XT-E
 FWHM 115.0°
 Efficiency 94 %
 Peak intensity 0.3 cd/lm
 LEDs/each optic 1
 Light colour White
 Required components:

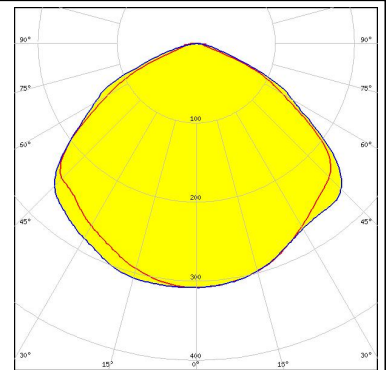

NICHIA

LED NVSW219D
 FWHM 114.0°
 Efficiency 94 %
 Peak intensity 0.4 cd/lm
 LEDs/each optic 1
 Light colour White
 Required components:

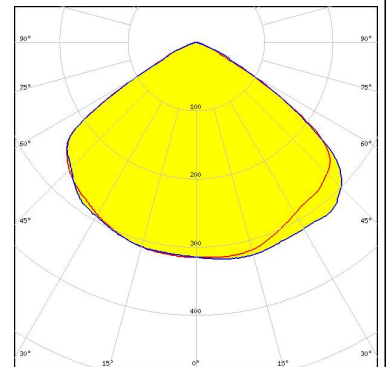
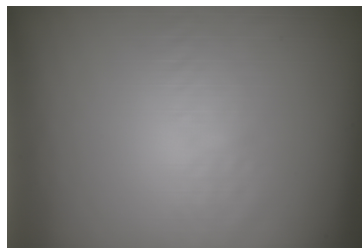

NICHIA

LED NVSW319B
 FWHM Asymmetric
 Efficiency 94 %
 Peak intensity 0.4 cd/lm
 LEDs/each optic 1
 Light colour White
 Required components:

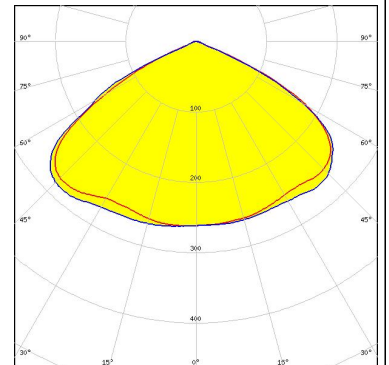

SAMSUNG

LED LH181B
 FWHM 116.0°
 Efficiency 94 %
 Peak intensity 0.4 cd/lm
 LEDs/each optic 1
 Light colour White
 Required components:

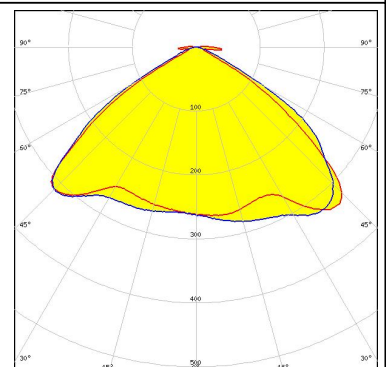

PHOTOMETRIC DATA (SIMULATED):



LED XP-E2
 FWHM 117.0°
 Efficiency 90 %
 Peak intensity 0.4 cd/lm
 LEDs/each optic 1
 Light colour White
 Required components:

Transparent protective cover

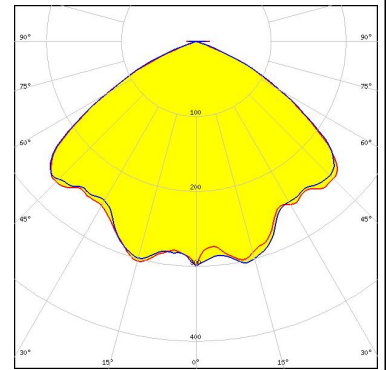

LED XP-G2 HE
 FWHM 121.0°
 Efficiency 95 %
 Peak intensity 0.3 cd/lm
 LEDs/each optic 1
 Light colour White
 Required components:

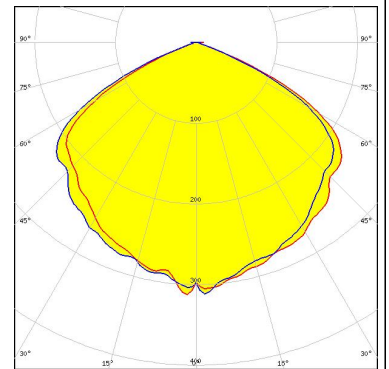

LED LUXEON IR Domed 150
 FWHM 133.0°
 Efficiency 94 %
 LEDs/each optic 1
 Light colour White
 Required components:



LED OSCONIQ P 3030
 FWHM 112.0°
 Efficiency 96 %
 Peak intensity 0.4 cd/lm
 LEDs/each optic 1
 Light colour White
 Required components:

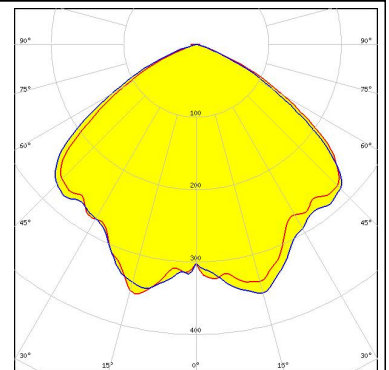

PHOTOMETRIC DATA (SIMULATED):

OSRAM

Opto Semiconductors

LED OSCONIQ P 3737 (2W version)
 FWHM 115.0°
 Efficiency 94 %
 Peak intensity 0.4 cd/lm
 LEDs/each optic 1
 Light colour White
 Required components:

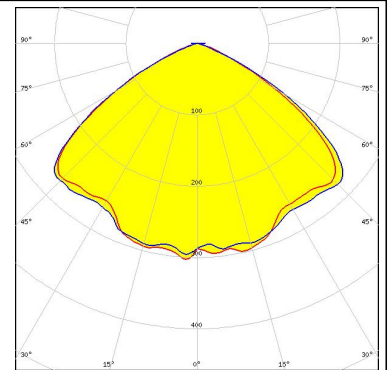

OSRAM

Opto Semiconductors

LED OSCONIQ P 3737 (3W version)
 FWHM 117.0°
 Efficiency 96 %
 Peak intensity 0.3 cd/lm
 LEDs/each optic 1
 Light colour White
 Required components:

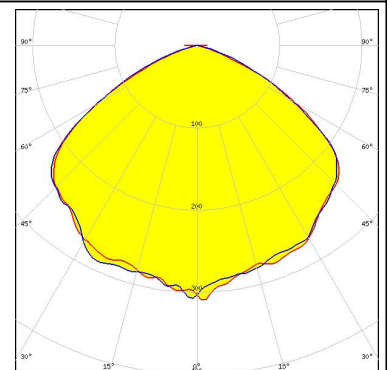

OSRAM

Opto Semiconductors

LED OSLOM Square CSSRM2/CSSRM3
 FWHM 120.0°
 Efficiency 96 %
 Peak intensity 0.3 cd/lm
 LEDs/each optic 1
 Light colour White
 Required components:

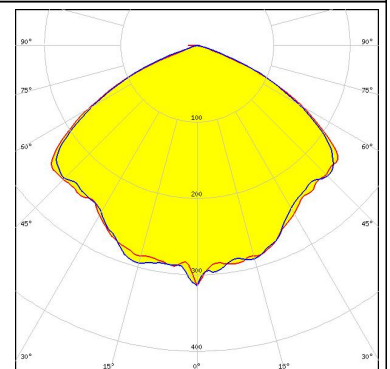

SAMSUNG

LED LH351B
 FWHM 110.0°
 Efficiency 92 %
 Peak intensity 0.3 cd/lm
 LEDs/each optic 1
 Light colour White
 Required components:

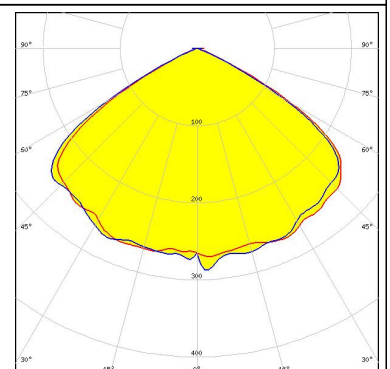

PHOTOMETRIC DATA (SIMULATED):

SAMSUNG

LED LH351D
 FWHM 123.0°
 Efficiency 94 %
 Peak intensity 0.3 cd/lm
 LEDs/each optic 1
 Light colour White
 Required components:

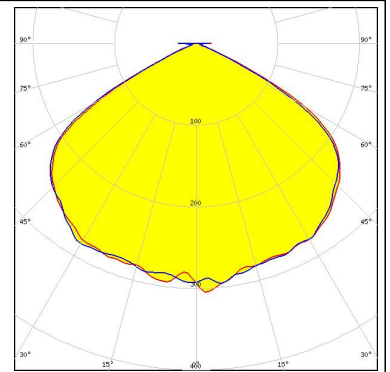

SEOUL SEMICONDUCTOR

LED SEOUL DC 5050 6V
 FWHM 114.0°
 Efficiency 94 %
 Peak intensity 0.3 cd/lm
 LEDs/each optic 1
 Light colour White
 Required components:

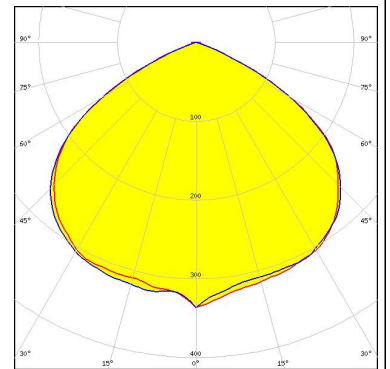

SEOUL SEMICONDUCTOR

LED Z5M1/Z5M2
 FWHM 118.0°
 Efficiency 96 %
 Peak intensity 0.4 cd/lm
 LEDs/each optic 1
 Light colour White
 Required components:

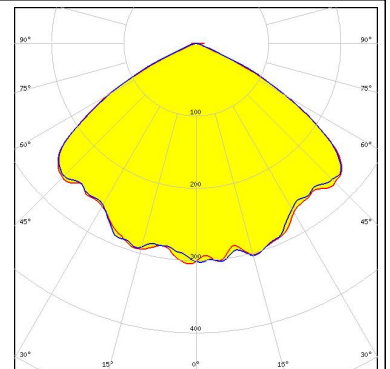

GENERAL INFORMATION:

NOTE: The typical beam angle will be changed by different color, chip size and chip position tolerance. The typical total beam angle is the full angle measured where the luminous intensity is half of the peak value.

MATERIALS:

As part of our continuous research and improvement processes, and to ensure the best possible quality and availability of our products, LEDiL reserves the right to change material grades without notice.

PRODUCT DATA USER AGREEMENT AND DISCLAIMER:

The measured data in the provided downloadable LEDiL Product Datasheets and Mechanical 2D-Drawings is rounded and provided as reference for planning. LEDiL Oy's optical specifications have been verified by conducting performance testing of the products in accordance with the company's quality system. The reported data are averaged results of multiple measurements with typical variation. LEDiL Oy reserves the right to without prior notification make changes and improvements to its products.

LEDiL Oy assumes neither warranty, nor guarantee nor any other liability of any kind for the contents and correctness of the provided data. The provided data has been generated with highest diligence but the provided data may in reality not represent the complete possible variation range of all intrinsic parameters. Therefore, in certain cases a deviation from the provided data could occur.

LEDiL Oy reserves the right to undertake technical changes of its products without further notification which could lead to changes in the provided data. LEDiL Oy assumes no liability of any kind for the possible deviation from any provided data or any other damage resulting from the usage of the provided data.

The user agrees to this disclaimer and user agreement with the download or usage of the provided files.

LEDiL Oy

Joensuunkatu 13
FI-24240 SALO
Finland

LEDiL Inc.

228 West Page Street
Suite D
Sycamore IL 60178
USA

Local sales and technical support

[www.ledil.com/
where_to_buy](http://www.ledil.com/where_to_buy)

Shipping locations

Salo, Finland
Hong Kong, China

Distribution Partners

[www.ledil.com/
where_to_buy](http://www.ledil.com/where_to_buy)



**Стандарт
Электрон
Связь**

Мы молодая и активно развивающаяся компания в области поставок электронных компонентов. Мы поставляем электронные компоненты отечественного и импортного производства напрямую от производителей и с крупнейших складов мира.

Благодаря сотрудничеству с мировыми поставщиками мы осуществляем комплексные и плановые поставки широчайшего спектра электронных компонентов.

Собственная эффективная логистика и склад в обеспечивает надежную поставку продукции в точно указанные сроки по всей России.

Мы осуществляем техническую поддержку нашим клиентам и предпродажную проверку качества продукции. На все поставляемые продукты мы предоставляем гарантию .

Осуществляем поставки продукции под контролем ВП МО РФ на предприятия военно-промышленного комплекса России , а также работаем в рамках 275 ФЗ с открытием отдельных счетов в уполномоченном банке. Система менеджмента качества компании соответствует требованиям ГОСТ ISO 9001.

Минимальные сроки поставки, гибкие цены, неограниченный ассортимент и индивидуальный подход к клиентам являются основой для выстраивания долгосрочного и эффективного сотрудничества с предприятиями радиоэлектронной промышленности, предприятиями ВПК и научно-исследовательскими институтами России.

С нами вы становитесь еще успешнее!

Наши контакты:

Телефон: +7 812 627 14 35

Электронная почта: sales@st-electron.ru

Адрес: 198099, Санкт-Петербург,
Промышленная ул, дом № 19, литера Н,
помещение 100-Н Офис 331