

# BC846BPDW1T1G, SBC846BPDW1T1G, BC847BPDW1T1G, SBC847BPDW1T1G Series, BC848CPDW1T1G



ON Semiconductor®

<http://onsemi.com>



SOT-363  
CASE 419B  
STYLE 1

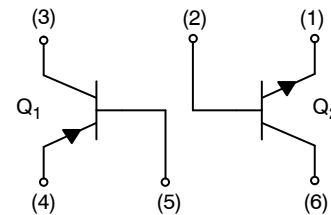
## Dual General Purpose Transistors

### NPN/PNP Duals (Complementary)

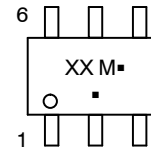
These transistors are designed for general purpose amplifier applications. They are housed in the SOT-363/SC-88 which is designed for low power surface mount applications.

#### Features

- AEC-Q101 Qualified and PPAP Capable
- S Prefix for Automotive and Other Applications Requiring Unique Site and Control Change Requirements
- These Devices are Pb-Free, Halogen Free/BFR Free and are RoHS Compliant\*



#### MARKING DIAGRAM



XX = Device Code  
M = Date Code  
▪ = Pb-Free Package

(Note: Microdot may be in either location)

#### MAXIMUM RATINGS – NPN

Rating	Symbol	Value	Unit
Collector-Emitter Voltage BC846, SBC846 BC847, SBC847 BC848	$V_{CEO}$	65 45 30	V
Collector-Base Voltage BC846, SBC846 BC847, SBC847 BC848	$V_{CBO}$	80 50 30	V
Emitter-Base Voltage	$V_{EBO}$	6.0	V
Collector Current – Continuous	$I_C$	100	mAdc

#### MAXIMUM RATINGS – PNP

Rating	Symbol	Value	Unit
Collector-Emitter Voltage BC846, SBC846 BC847, SBC847 BC848	$V_{CEO}$	-65 -45 -30	V
Collector-Base Voltage BC846, SBC846 BC847, SBC847 BC848	$V_{CBO}$	-80 -50 -30	V
Emitter-Base Voltage	$V_{EBO}$	-5.0	V
Collector Current – Continuous	$I_C$	-100	mAdc

Stresses exceeding Maximum Ratings may damage the device. Maximum Ratings are stress ratings only. Functional operation above the Recommended Operating Conditions is not implied. Extended exposure to stresses above the Recommended Operating Conditions may affect device reliability.

\*For additional information on our Pb-Free strategy and soldering details, please download the ON Semiconductor Soldering and Mounting Techniques Reference Manual, SOLDERRM/D.

#### ORDERING INFORMATION

Device	Mark	Package	Shipping†
BC846BPDW1T1G	BB	SOT-363 (Pb-Free)	3,000 / Tape & Reel
SBC846BPDW1T1G	BB	SOT-363 (Pb-Free)	3,000 / Tape & Reel
SBC846BPDW1T2G	BB	SOT-363 (Pb-Free)	3,000 / Tape & Reel
BC847BPDW1T1G	BF	SOT-363 (Pb-Free)	3,000 / Tape & Reel
SBC847BPDW1T1G	BF	SOT-363 (Pb-Free)	3,000 / Tape & Reel
BC847BPDW1T2G	BF	SOT-363 (Pb-Free)	3,000 / Tape & Reel
BC848CPDW1T1G	BL	SOT-363 (Pb-Free)	3,000 / Tape & Reel

†For information on tape and reel specifications, including part orientation and tape sizes, please refer to our Tape and Reel Packaging Specification Brochure, BRD8011/D.

**BC846BPDW1T1G, SBC846BPDW1T1G, BC847BPDW1T1G,  
SBC847BPDW1T1G Series, BC848CPDW1T1G**

**THERMAL CHARACTERISTICS**

Characteristic	Symbol	Max	Unit
Total Device Dissipation Per Device FR-5 Board (Note 1) $T_A = 25^\circ\text{C}$ Derate above $25^\circ\text{C}$	$P_D$	380 250 3.0	mW mW/ $^\circ\text{C}$ mW/ $^\circ\text{C}$
Thermal Resistance, Junction-to-Ambient	$R_{\theta JA}$	328	$^\circ\text{C/W}$
Junction and Storage Temperature	$T_J, T_{stg}$	-55 to +150	$^\circ\text{C}$

1. FR-5 = 1.0 x 0.75 x 0.062 in.

**ELECTRICAL CHARACTERISTICS (NPN)** ( $T_A = 25^\circ\text{C}$  unless otherwise noted)

Characteristic	Symbol	Min	Typ	Max	Unit
----------------	--------	-----	-----	-----	------

**OFF CHARACTERISTICS**

Collector - Emitter Breakdown Voltage ( $I_C = 10\text{ mA}$ ) BC846, SBC846 Series BC847, SBC847 Series BC848 Series	$V_{(BR)CEO}$	65 45 30	- - -	- - -	V
Collector - Emitter Breakdown Voltage ( $I_C = 10\ \mu\text{A}, V_{EB} = 0$ ) BC846, SBC846 Series BC847B, SBC847B Only BC848 Series	$V_{(BR)CES}$	80 50 30	- - -	- - -	V
Collector - Base Breakdown Voltage ( $I_C = 10\ \mu\text{A}$ ) BC846, SBC846 Series BC847, SBC847 Series BC848 Series	$V_{(BR)CBO}$	80 50 30	- - -	- - -	V
Emitter - Base Breakdown Voltage ( $I_E = 1.0\ \mu\text{A}$ ) BC846, SBC846 Series BC847, SBC847 Series BC848 Series	$V_{(BR)EBO}$	6.0 6.0 5.0	- - -	- - -	V
Collector Cutoff Current ( $V_{CB} = 30\text{ V}$ ) ( $V_{CB} = 30\text{ V}, T_A = 150^\circ\text{C}$ )	$I_{CBO}$	- -	- -	15 5.0	nA $\mu\text{A}$

**ON CHARACTERISTICS**

DC Current Gain ( $I_C = 10\ \mu\text{A}, V_{CE} = 5.0\text{ V}$ ) BC846B, SBC846B, BC847B, SBC847B BC848C ( $I_C = 2.0\text{ mA}, V_{CE} = 5.0\text{ V}$ ) BC846B, SBC846B, BC847B, SBC847B BC848C	$h_{FE}$	- - 200 420	150 270 290 520	- - 475 800	-
Collector - Emitter Saturation Voltage ( $I_C = 10\text{ mA}, I_B = 0.5\text{ mA}$ ) ( $I_C = 100\text{ mA}, I_B = 5.0\text{ mA}$ )	$V_{CE(sat)}$	- -	- -	0.25 0.6	V
Base - Emitter Saturation Voltage ( $I_C = 10\text{ mA}, I_B = 0.5\text{ mA}$ ) ( $I_C = 100\text{ mA}, I_B = 5.0\text{ mA}$ )	$V_{BE(sat)}$	- -	0.7 0.9	- -	V
Base - Emitter Voltage ( $I_C = 2.0\text{ mA}, V_{CE} = 5.0\text{ V}$ ) ( $I_C = 10\text{ mA}, V_{CE} = 5.0\text{ V}$ )	$V_{BE(on)}$	580 -	660 -	700 770	mV

**SMALL-SIGNAL CHARACTERISTICS**

Current - Gain - Bandwidth Product ( $I_C = 10\text{ mA}, V_{CE} = 5.0\text{ Vdc}, f = 100\text{ MHz}$ )	$f_T$	100	-	-	MHz
Output Capacitance ( $V_{CB} = 10\text{ V}, f = 1.0\text{ MHz}$ )	$C_{obo}$	-	-	4.5	pF
Noise Figure ( $I_C = 0.2\text{ mA}, V_{CE} = 5.0\text{ Vdc}, R_S = 2.0\text{ k}\Omega, f = 1.0\text{ kHz}, BW = 200\text{ Hz}$ )	NF	-	-	10	dB

**BC846BPDW1T1G, SBC846BPDW1T1G, BC847BPDW1T1G,  
SBC847BPDW1T1G Series, BC848CPDW1T1G**

**ELECTRICAL CHARACTERISTICS (PNP)** ( $T_A = 25^\circ\text{C}$  unless otherwise noted)

Characteristic	Symbol	Min	Typ	Max	Unit
<b>OFF CHARACTERISTICS</b>					
Collector – Emitter Breakdown Voltage ( $I_C = -10\text{ mA}$ ) BC846, SBC846 Series BC847, SBC847 Series BC848 Series	$V_{(BR)CEO}$	-65 -45 -30	-	-	V
Collector – Emitter Breakdown Voltage ( $I_C = -10\text{ }\mu\text{A}$ , $V_{EB} = 0$ ) BC846, SBC846 Series BC847, SBC847 Series BC848 Series	$V_{(BR)CES}$	-80 -50 -30	-	-	V
Collector – Base Breakdown Voltage ( $I_C = -10\text{ }\mu\text{A}$ ) BC846, SBC846 Series BC847, SBC847 Series BC848 Series	$V_{(BR)CBO}$	-80 -50 -30	-	-	V
Emitter – Base Breakdown Voltage ( $I_E = -1.0\text{ }\mu\text{A}$ ) BC846, SBC846 Series BC847, SBC847 Series BC848 Series	$V_{(BR)EBO}$	-5.0 -5.0 -5.0	-	-	V
Collector Cutoff Current ( $V_{CB} = -30\text{ V}$ ) ( $V_{CB} = -30\text{ V}$ , $T_A = 150^\circ\text{C}$ )	$I_{CBO}$	-	-	-15 -4.0	nA $\mu\text{A}$

**ON CHARACTERISTICS**

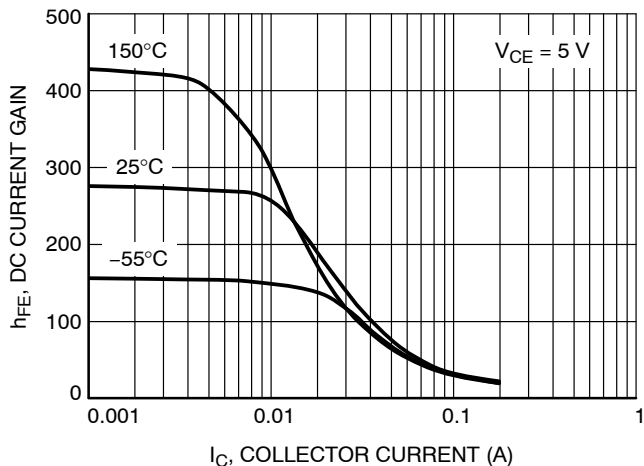
DC Current Gain ( $I_C = -10\text{ }\mu\text{A}$ , $V_{CE} = -5.0\text{ V}$ ) BC846B, SBC846B, BC847B, SBC847B BC848C ( $I_C = -2.0\text{ mA}$ , $V_{CE} = -5.0\text{ V}$ ) BC846B, SBC846B, BC847B, SBC847B BC848C	$h_{FE}$	- - 200 420	150 270 290 520	- - 475 800	-
Collector – Emitter Saturation Voltage ( $I_C = -10\text{ mA}$ , $I_B = -0.5\text{ mA}$ ) ( $I_C = -100\text{ mA}$ , $I_B = -5.0\text{ mA}$ )	$V_{CE(sat)}$	- -	- -	-0.3 -0.65	V
Base – Emitter Saturation Voltage ( $I_C = -10\text{ mA}$ , $I_B = -0.5\text{ mA}$ ) ( $I_C = -100\text{ mA}$ , $I_B = -5.0\text{ mA}$ )	$V_{BE(sat)}$	- -	-0.7 -0.9	- -	V
Base – Emitter On Voltage ( $I_C = -2.0\text{ mA}$ , $V_{CE} = -5.0\text{ V}$ ) ( $I_C = -10\text{ mA}$ , $V_{CE} = -5.0\text{ V}$ )	$V_{BE(on)}$	-0.6 -	- -	-0.75 -0.82	V

**SMALL-SIGNAL CHARACTERISTICS**

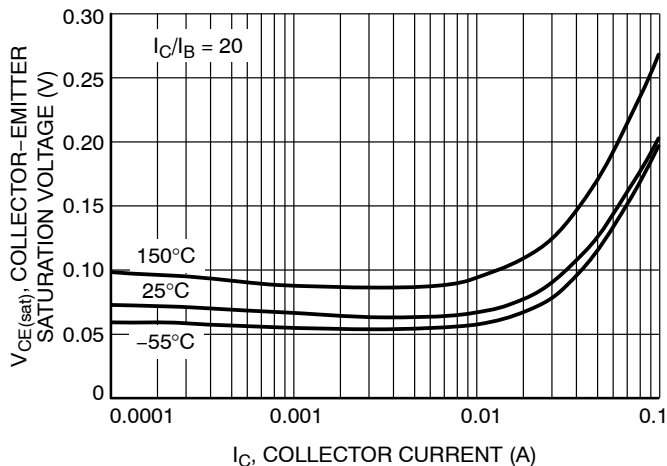
Current – Gain – Bandwidth Product ( $I_C = -10\text{ mA}$ , $V_{CE} = -5.0\text{ Vdc}$ , $f = 100\text{ MHz}$ )	$f_T$	100	-	-	MHz
Output Capacitance ( $V_{CB} = -10\text{ V}$ , $f = 1.0\text{ MHz}$ )	$C_{ob}$	-	-	4.5	pF
Noise Figure ( $I_C = -0.2\text{ mA}$ , $V_{CE} = -5.0\text{ Vdc}$ , $R_S = 2.0\text{ k}\Omega$ , $f = 1.0\text{ kHz}$ , $BW = 200\text{ Hz}$ )	NF	-	-	10	dB

**BC846BPDW1T1G, SBC846BPDW1T1G, BC847BPDW1T1G,  
SBC847BPDW1T1G Series, BC848CPDW1T1G**

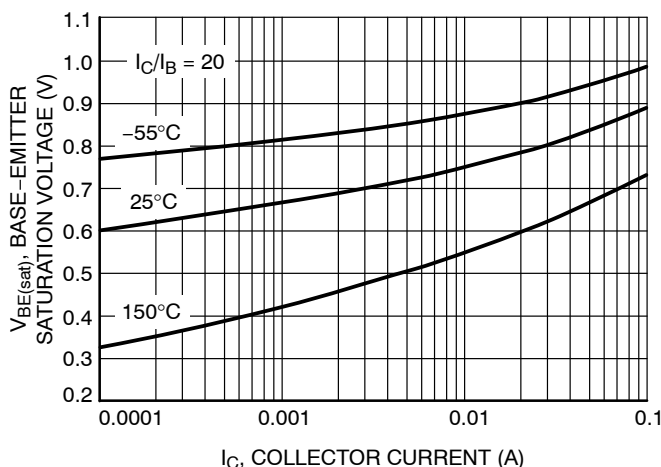
**TYPICAL NPN CHARACTERISTICS – BC846/SBC846**



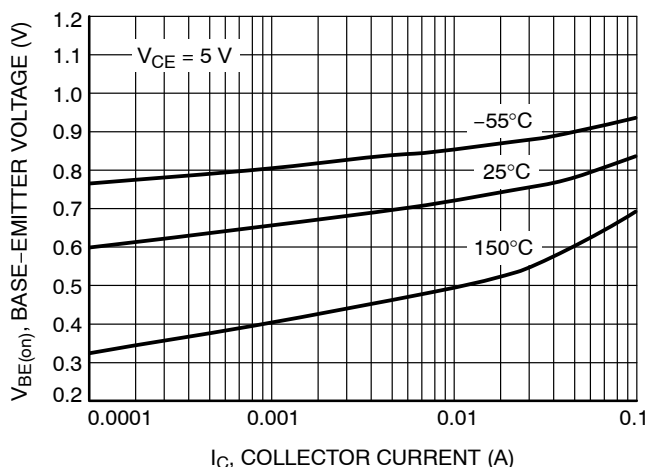
**Figure 1. DC Current Gain vs. Collector Current**



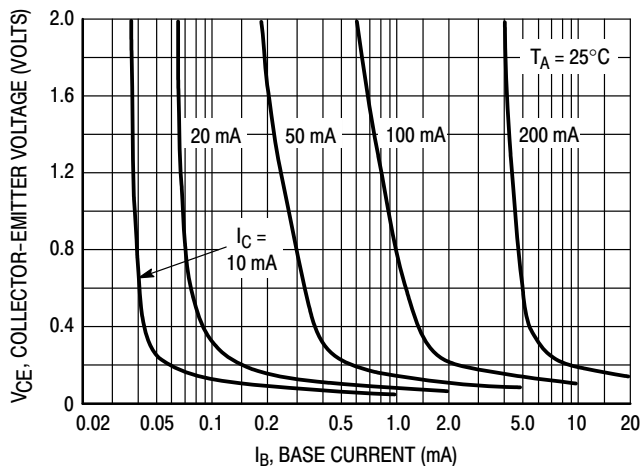
**Figure 2. Collector Emitter Saturation Voltage vs. Collector Current**



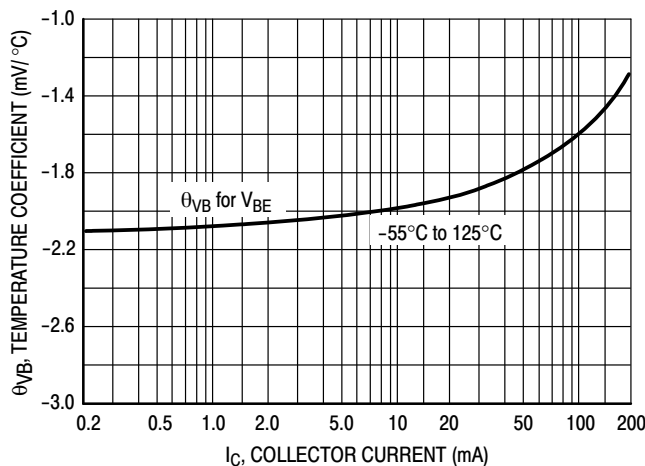
**Figure 3. Base Emitter Saturation Voltage vs. Collector Current**



**Figure 4. Base Emitter Voltage vs. Collector Current**



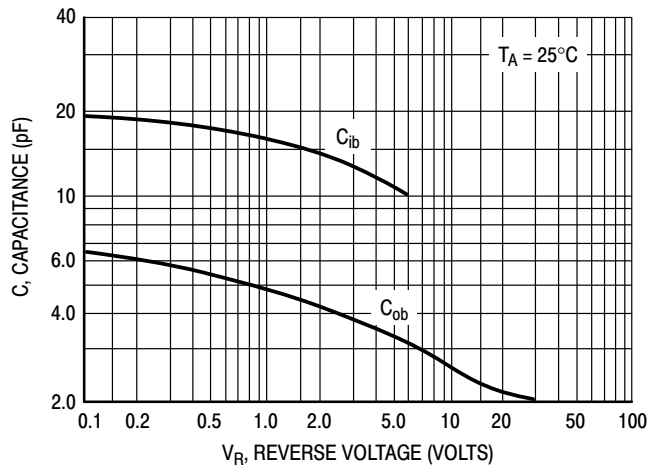
**Figure 5. Collector Saturation Region**



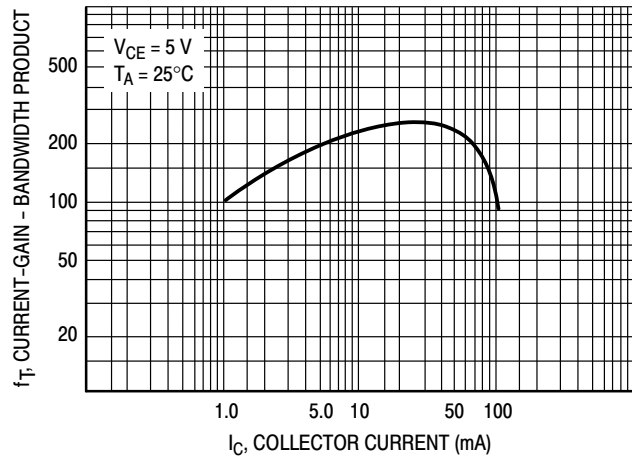
**Figure 6. Base-Emitter Temperature Coefficient**

**BC846BPDW1T1G, SBC846BPDW1T1G, BC847BPDW1T1G,  
SBC847BPDW1T1G Series, BC848CPDW1T1G**

**TYPICAL NPN CHARACTERISTICS – BC846/SBC846**



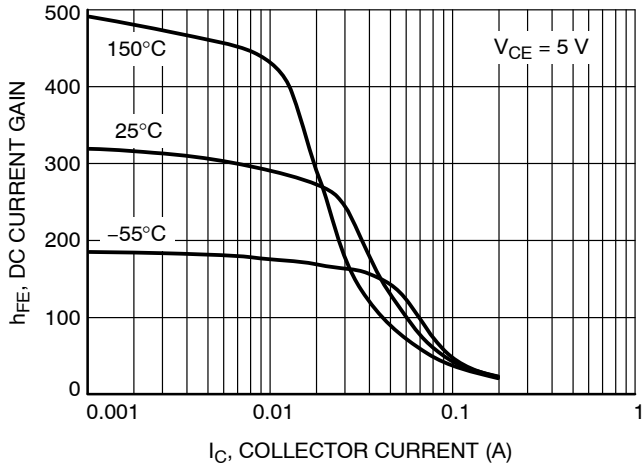
**Figure 7. Capacitance**



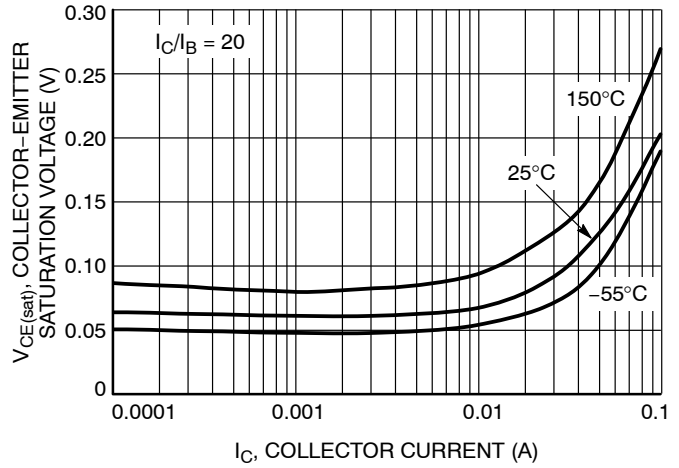
**Figure 8. Current-Gain - Bandwidth Product**

**BC846BPDW1T1G, SBC846BPDW1T1G, BC847BPDW1T1G,  
SBC847BPDW1T1G Series, BC848CPDW1T1G**

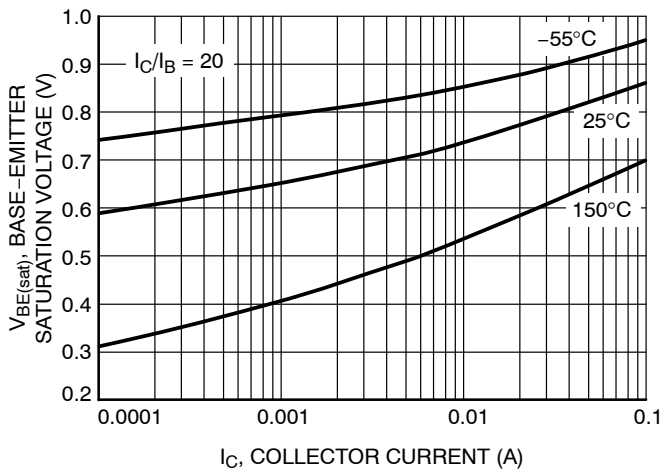
**TYPICAL PNP CHARACTERISTICS — BC846/SBC846**



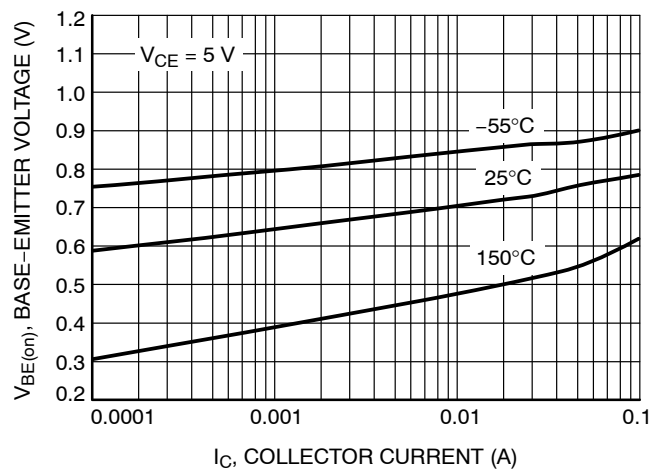
**Figure 9. DC Current Gain vs. Collector Current**



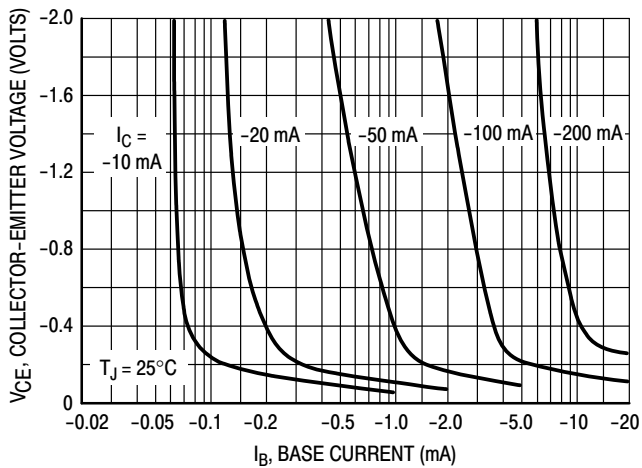
**Figure 10. Collector Emitter Saturation Voltage vs. Collector Current**



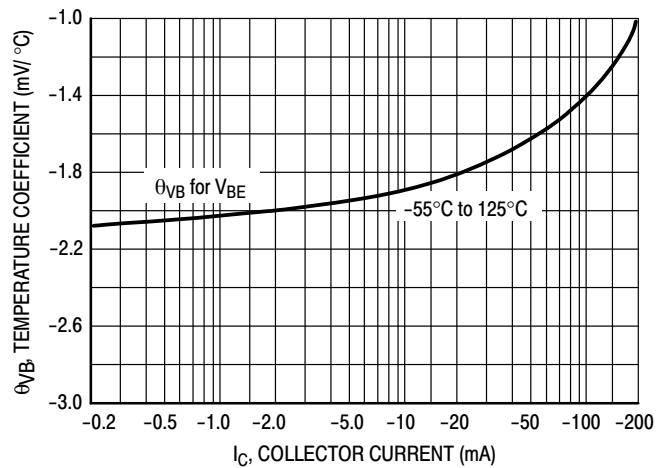
**Figure 11. Base Emitter Saturation Voltage vs. Collector Current**



**Figure 12. Base Emitter Voltage vs. Collector Current**



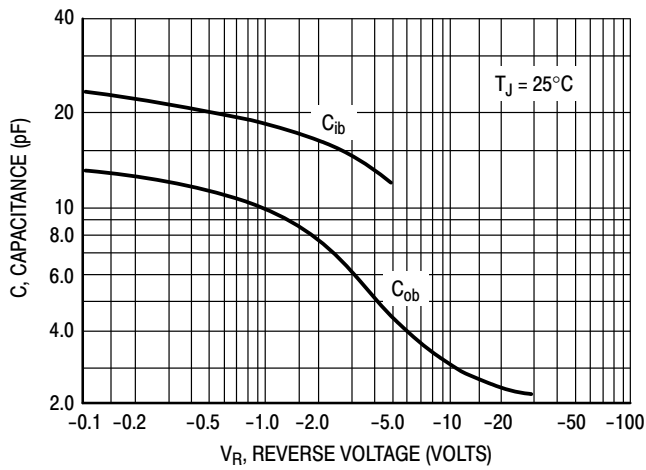
**Figure 13. Collector Saturation Region**



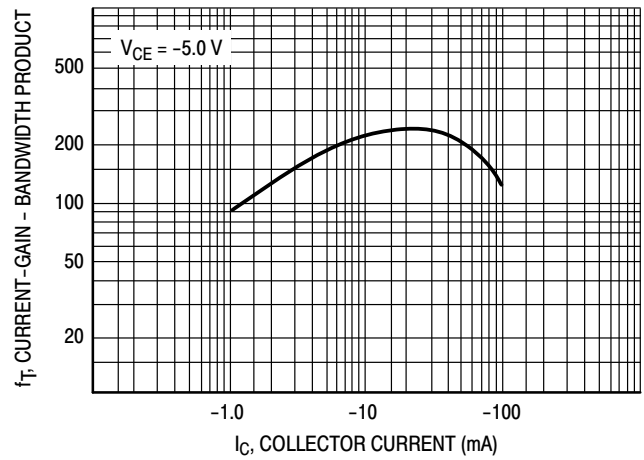
**Figure 14. Base-Emitter Temperature Coefficient**

**BC846BPDW1T1G, SBC846BPDW1T1G, BC847BPDW1T1G,  
SBC847BPDW1T1G Series, BC848CPDW1T1G**

**TYPICAL PNP CHARACTERISTICS — BC846/SBC846**



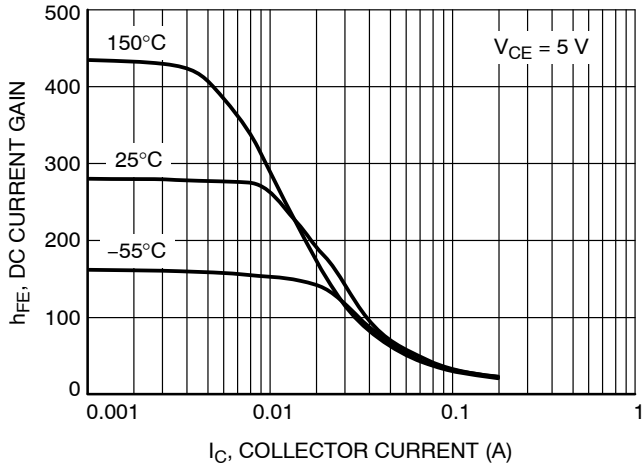
**Figure 15. Capacitance**



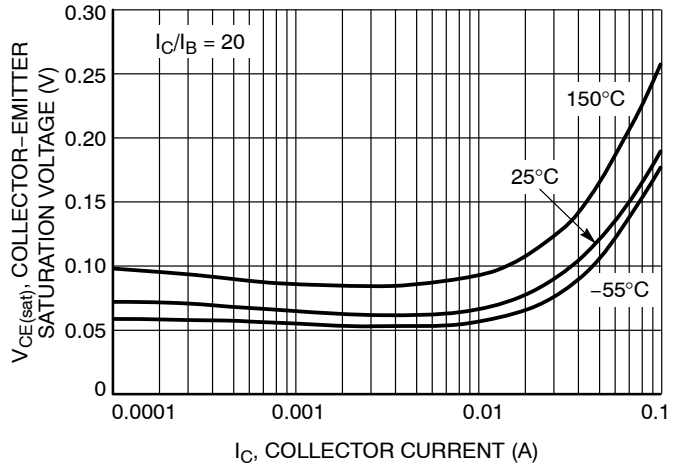
**Figure 16. Current-Gain - Bandwidth Product**

**BC846BPDW1T1G, SBC846BPDW1T1G, BC847BPDW1T1G,  
SBC847BPDW1T1G Series, BC848CPDW1T1G**

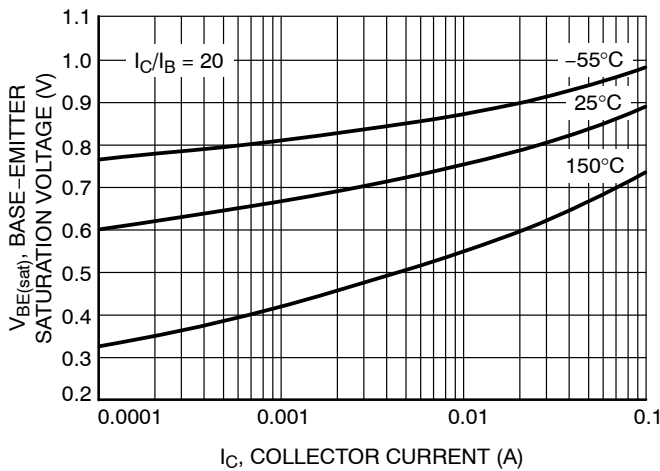
**TYPICAL NPN CHARACTERISTICS – BC847/SBC847 SERIES**



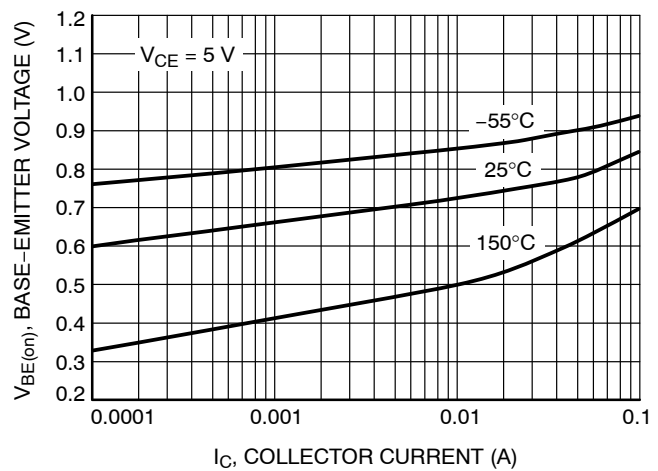
**Figure 17. DC Current Gain vs. Collector Current**



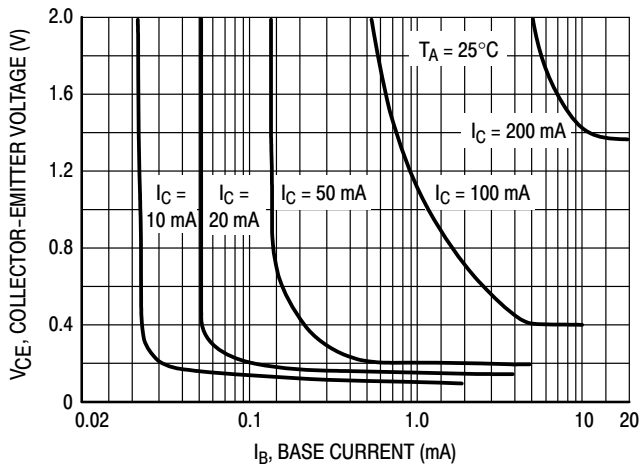
**Figure 18. Collector Emitter Saturation Voltage vs. Collector Current**



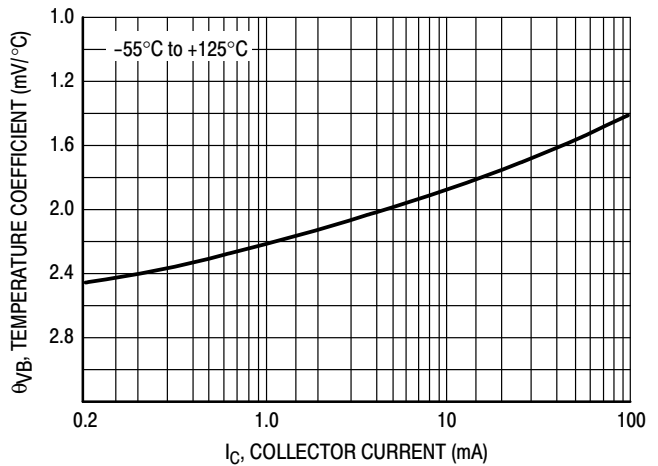
**Figure 19. Base Emitter Saturation Voltage vs. Collector Current**



**Figure 20. Base Emitter Voltage vs. Collector Current**



**Figure 21. Collector Saturation Region**

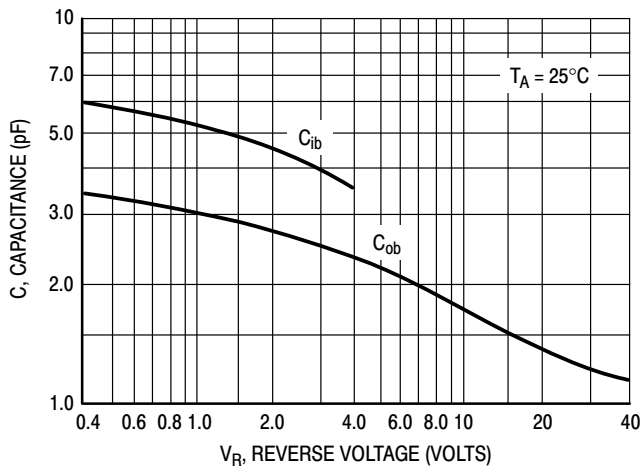


**Figure 22. Base-Emitter Temperature Coefficient**

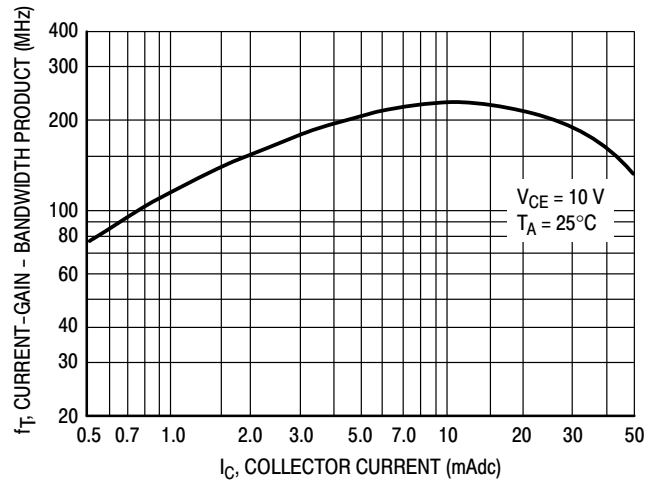


**BC846BPDW1T1G, SBC846BPDW1T1G, BC847BPDW1T1G,  
SBC847BPDW1T1G Series, BC848CPDW1T1G**

**TYPICAL NPN CHARACTERISTICS – BC847/SBC847 SERIES**



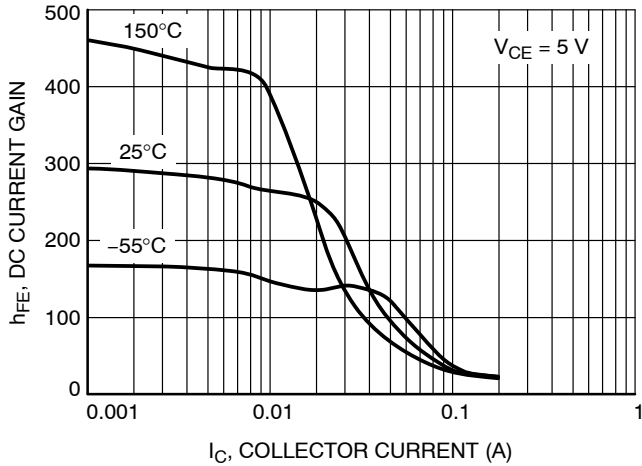
**Figure 23. Capacitances**



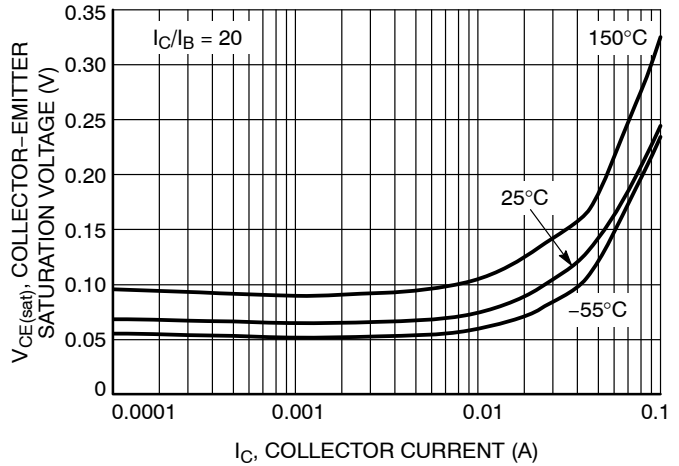
**Figure 24. Current-Gain - Bandwidth Product**

**BC846BPDW1T1G, SBC846BPDW1T1G, BC847BPDW1T1G,  
SBC847BPDW1T1G Series, BC848CPDW1T1G**

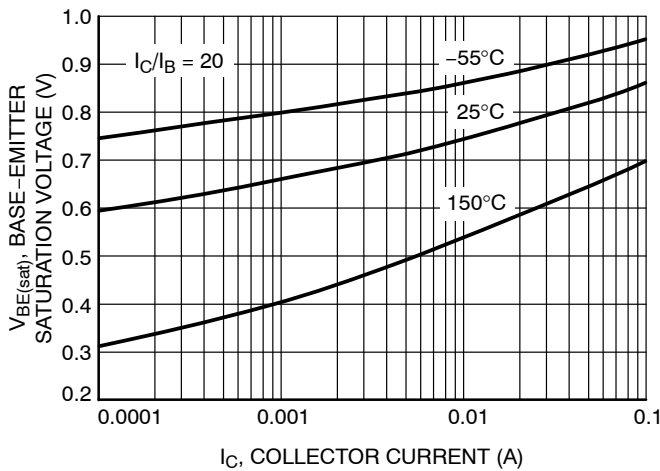
**TYPICAL PNP CHARACTERISTICS – BC847/SBC847 SERIES**



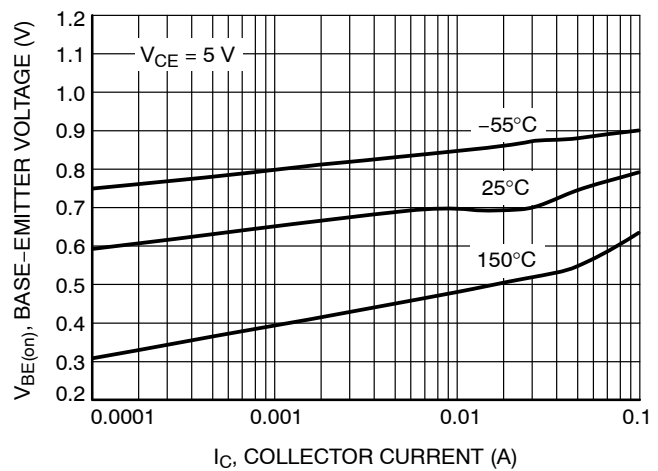
**Figure 25. DC Current Gain vs. Collector Current**



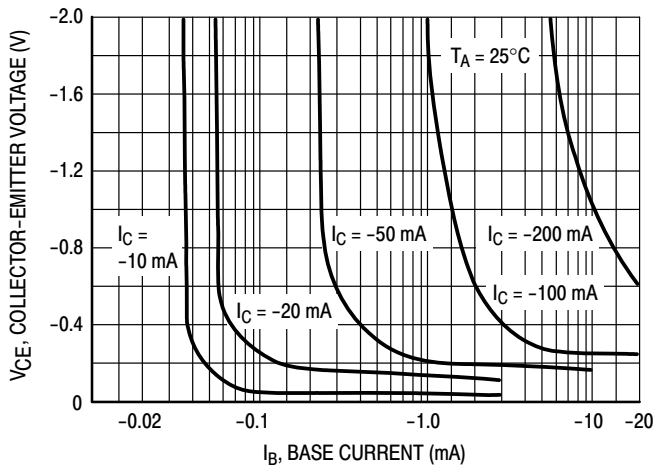
**Figure 26. Collector Emitter Saturation Voltage vs. Collector Current**



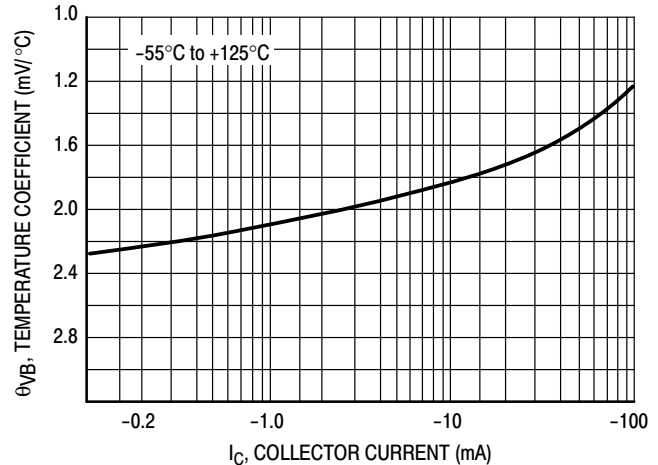
**Figure 27. Base Emitter Saturation Voltage vs. Collector Current**



**Figure 28. Base Emitter Voltage vs. Collector Current**



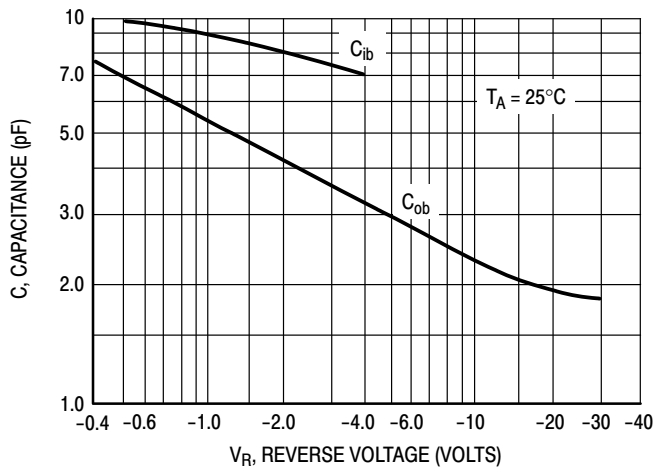
**Figure 29. Collector Saturation Region**



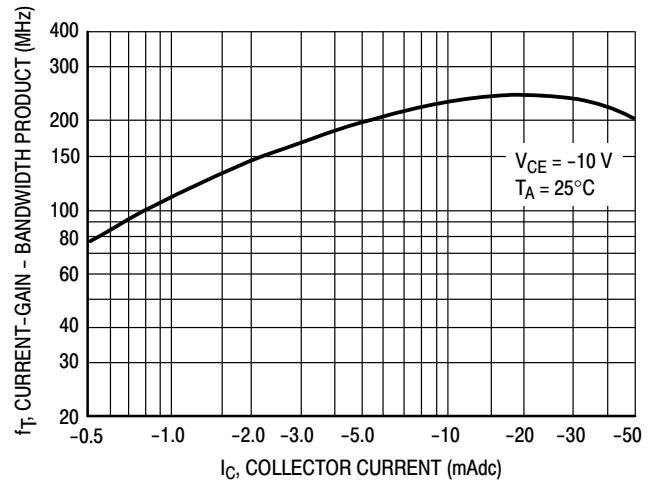
**Figure 30. Base-Emitter Temperature Coefficient**

**BC846BPDW1T1G, SBC846BPDW1T1G, BC847BPDW1T1G,  
SBC847BPDW1T1G Series, BC848CPDW1T1G**

**TYPICAL PNP CHARACTERISTICS – BC847/SBC847 SERIES**



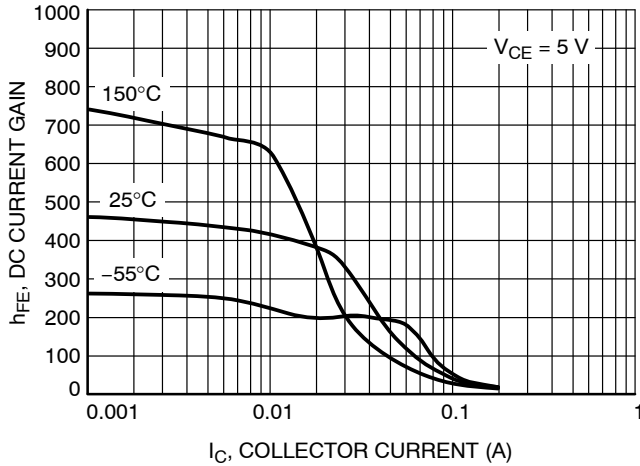
**Figure 31. Capacitances**



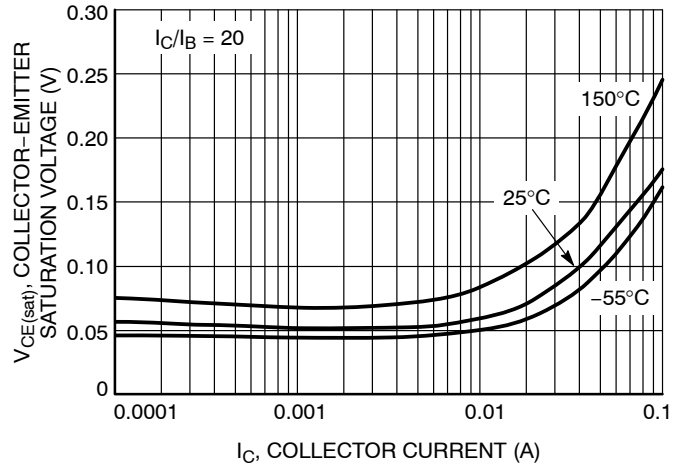
**Figure 32. Current-Gain - Bandwidth Product**

**BC846BPDW1T1G, SBC846BPDW1T1G, BC847BPDW1T1G,  
SBC847BPDW1T1G Series, BC848CPDW1T1G**

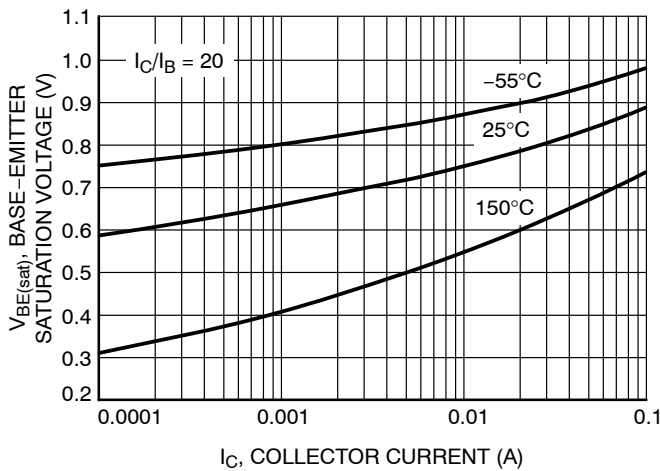
**TYPICAL NPN CHARACTERISTICS - BC848 SERIES**



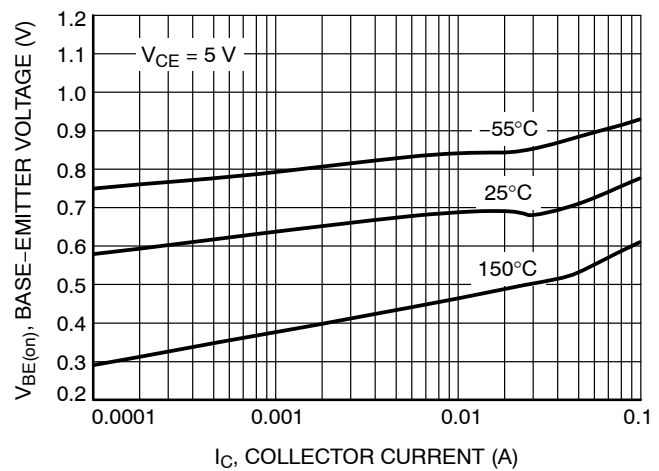
**Figure 33. DC Current Gain vs. Collector Current**



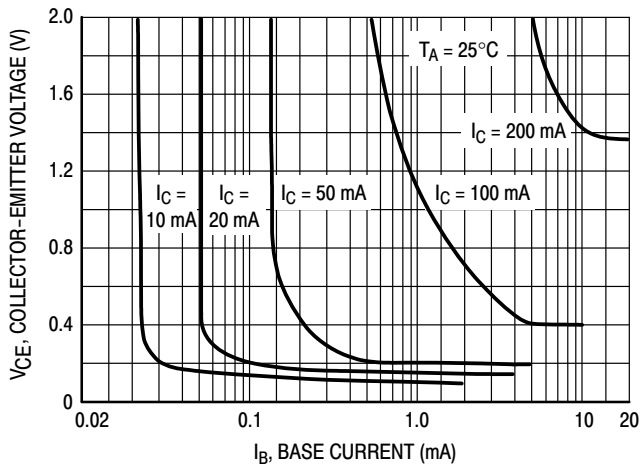
**Figure 34. Collector Emitter Saturation Voltage vs. Collector Current**



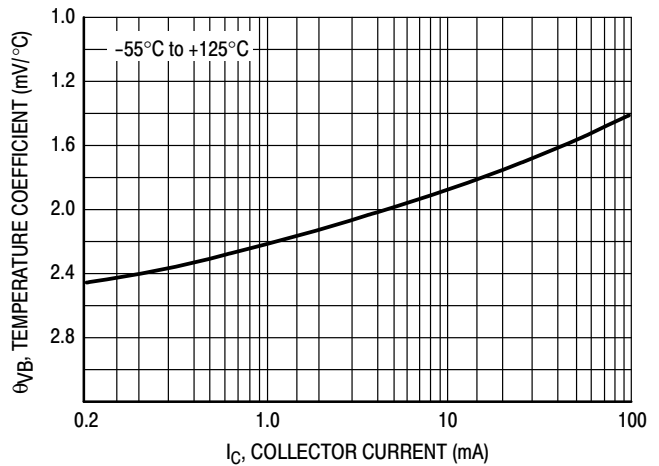
**Figure 35. Base Emitter Saturation Voltage vs. Collector Current**



**Figure 36. Base Emitter Voltage vs. Collector Current**



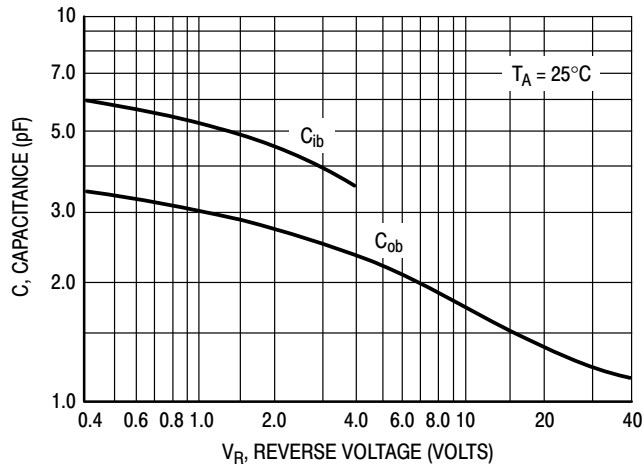
**Figure 37. Collector Saturation Region**



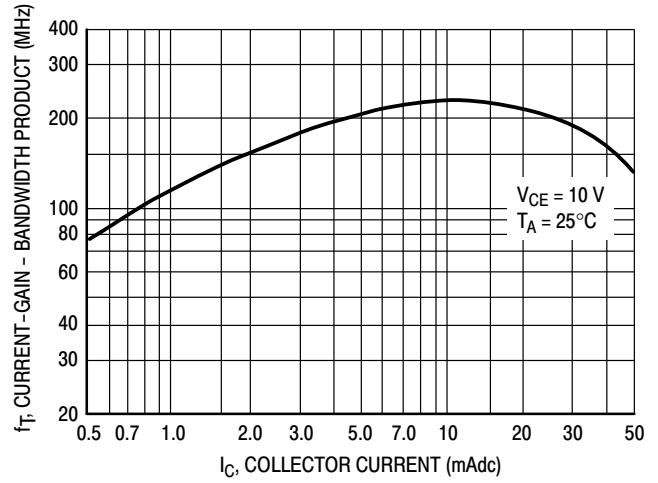
**Figure 38. Base-Emitter Temperature Coefficient**

**BC846BPDW1T1G, SBC846BPDW1T1G, BC847BPDW1T1G,  
SBC847BPDW1T1G Series, BC848CPDW1T1G**

**TYPICAL NPN CHARACTERISTICS – BC848 SERIES**



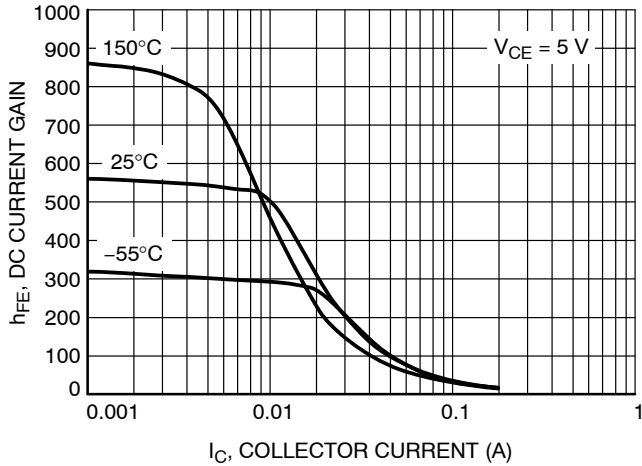
**Figure 39. Capacitances**



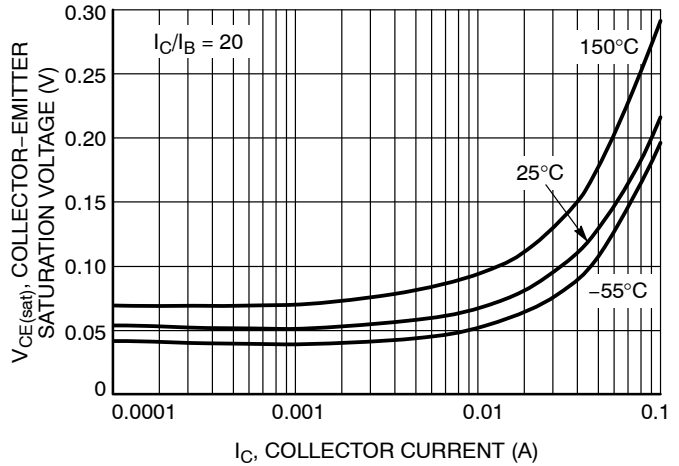
**Figure 40. Current-Gain - Bandwidth Product**

**BC846BPDW1T1G, SBC846BPDW1T1G, BC847BPDW1T1G,  
SBC847BPDW1T1G Series, BC848CPDW1T1G**

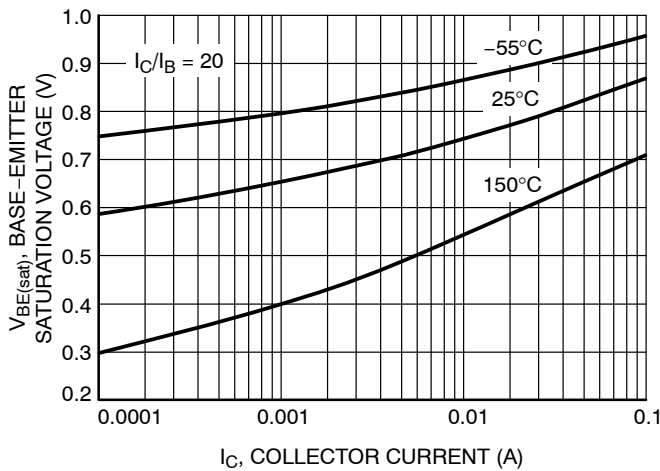
**TYPICAL PNP CHARACTERISTICS - BC848 SERIES**



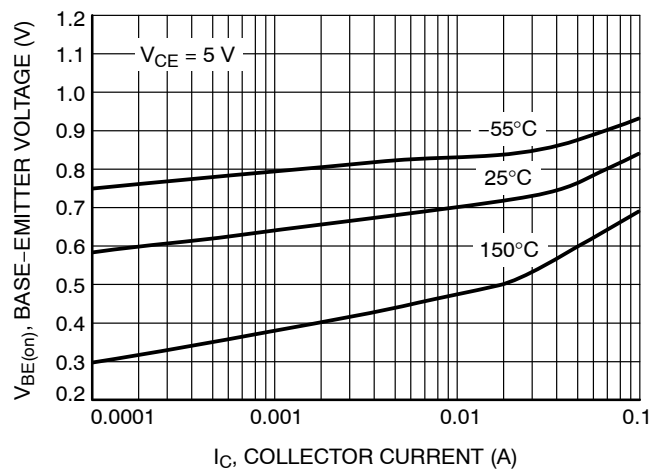
**Figure 41. DC Current Gain vs. Collector Current**



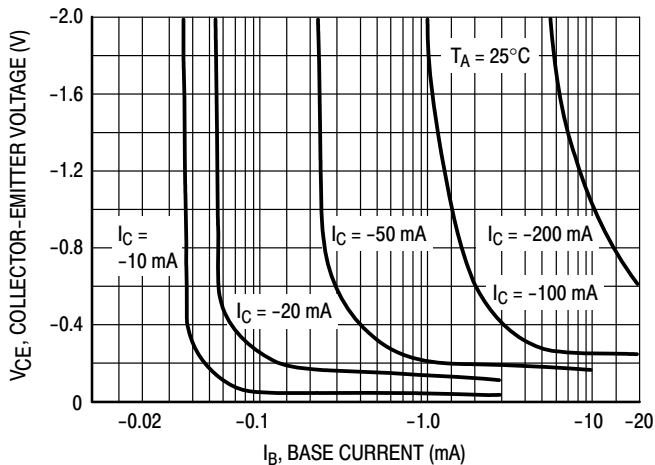
**Figure 42. Collector Emitter Saturation Voltage vs. Collector Current**



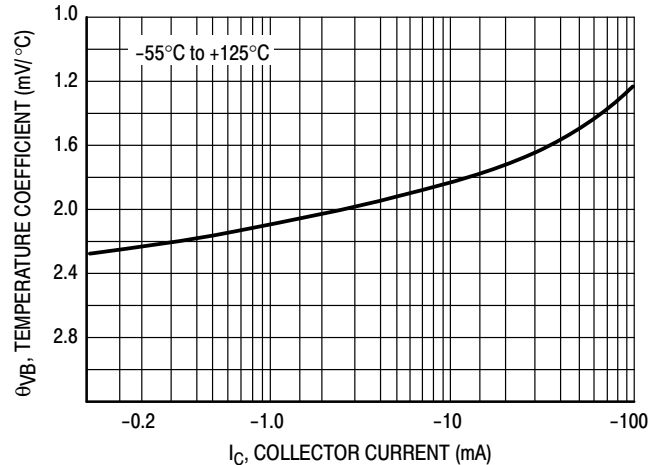
**Figure 43. Base Emitter Saturation Voltage vs. Collector Current**



**Figure 44. Base Emitter Voltage vs. Collector Current**



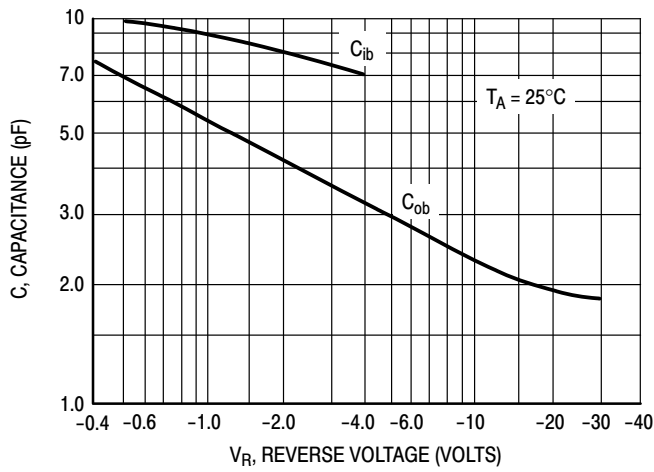
**Figure 45. Collector Saturation Region**



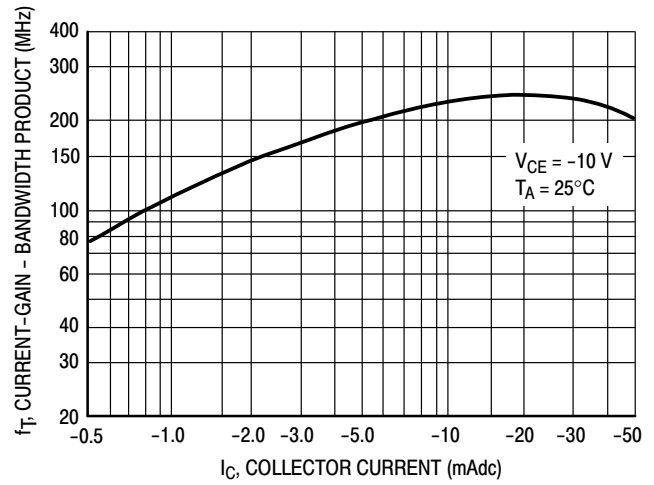
**Figure 46. Base-Emitter Temperature Coefficient**

**BC846BPDW1T1G, SBC846BPDW1T1G, BC847BPDW1T1G,  
SBC847BPDW1T1G Series, BC848CPDW1T1G**

**TYPICAL PNP CHARACTERISTICS – BC848 SERIES**

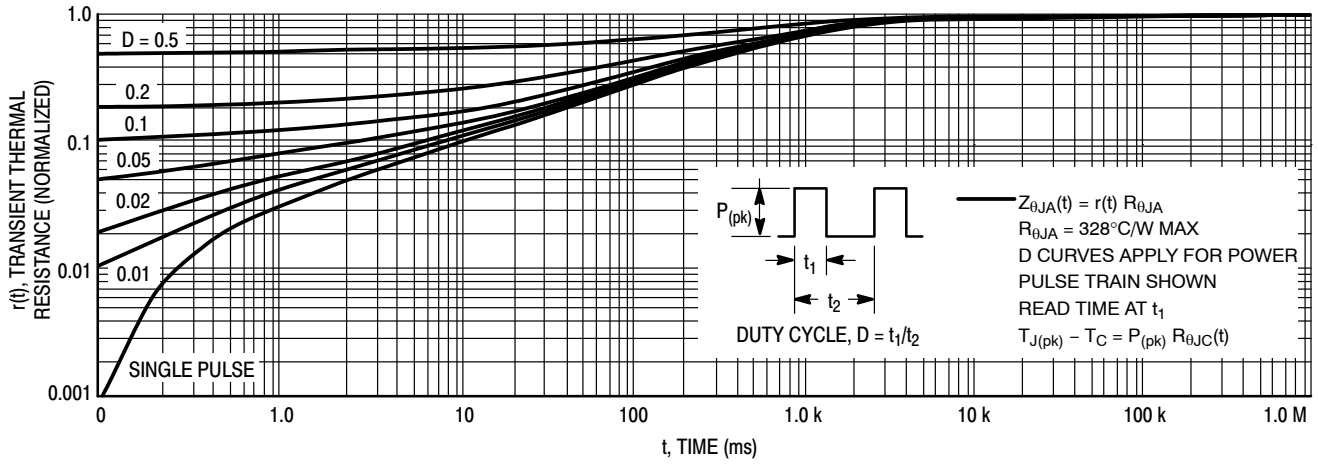


**Figure 47. Capacitances**

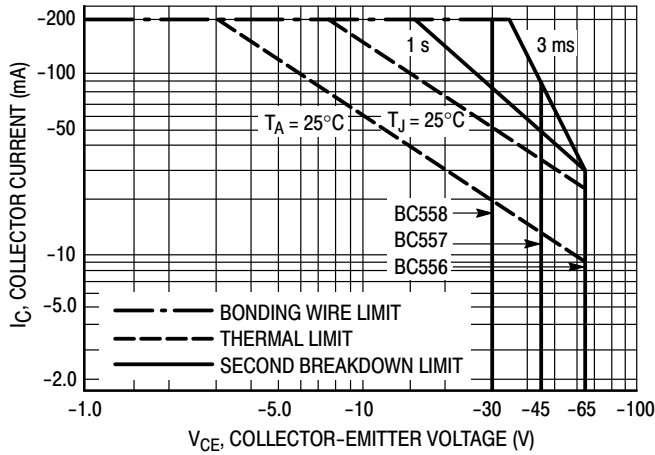


**Figure 48. Current-Gain - Bandwidth Product**

**BC846BPDW1T1G, SBC846BPDW1T1G, BC847BPDW1T1G,  
SBC847BPDW1T1G Series, BC848CPDW1T1G**



**Figure 49. Thermal Response**



**Figure 50. Active Region Safe Operating Area**

The safe operating area curves indicate  $I_C$ - $V_{CE}$  limits of the transistor that must be observed for reliable operation. Collector load lines for specific circuits must fall below the limits indicated by the applicable curve.

The data of Figure 50 is based upon  $T_{J(pk)} = 150^\circ\text{C}$ ;  $T_C$  or  $T_A$  is variable depending upon conditions. Pulse curves are valid for duty cycles to 10% provided  $T_{J(pk)} \leq 150^\circ\text{C}$ .  $T_{J(pk)}$  may be calculated from the data in Figure 49. At high case or ambient temperatures, thermal limitations will reduce the power that can be handled to values less than the limitations imposed by the secondary breakdown.



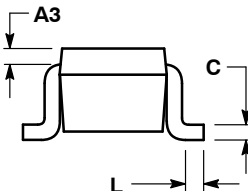
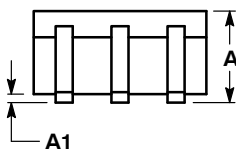
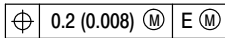
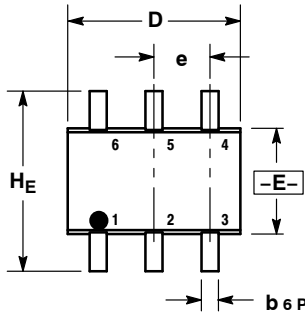
# BC846BPDW1T1G, SBC846BPDW1T1G, BC847BPDW1T1G, SBC847BPDW1T1G Series, BC848CPDW1T1G

## PACKAGE DIMENSIONS

SC-88/SOT-363/SC70-6

CASE 419B-02

ISSUE W



NOTES:

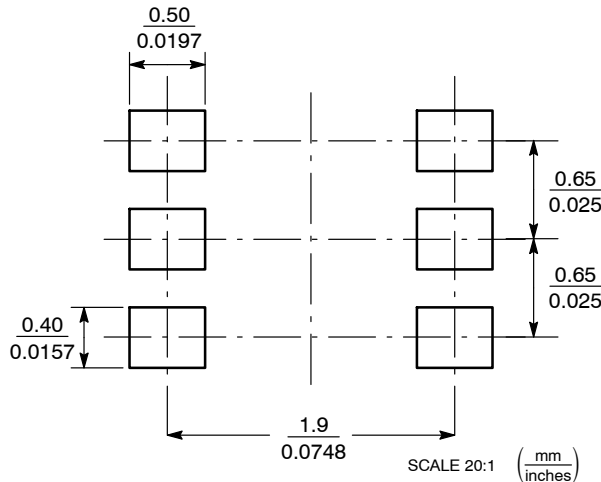
1. DIMENSIONING AND TOLERANCING PER ANSI Y14.5M, 1982.
2. CONTROLLING DIMENSION: INCH.
3. 419B-01 OBSOLETE, NEW STANDARD 419B-02.

DIM	MILLIMETERS			INCHES		
	MIN	NOM	MAX	MIN	NOM	MAX
A	0.80	0.95	1.10	0.031	0.037	0.043
A1	0.00	0.05	0.10	0.000	0.002	0.004
A3	0.20 REF			0.008 REF		
b	0.10	0.21	0.30	0.004	0.008	0.012
C	0.10	0.14	0.25	0.004	0.005	0.010
D	1.80	2.00	2.20	0.070	0.078	0.086
E	1.15	1.25	1.35	0.045	0.049	0.053
e	0.65 BSC			0.026 BSC		
L	0.10	0.20	0.30	0.004	0.008	0.012
HE	2.00	2.10	2.20	0.078	0.082	0.086

STYLE 1:

- PIN 1. EMITTER 2
- BASE 2
- COLLECTOR 1
- EMITTER 1
- BASE 1
- COLLECTOR 2

### SOLDERING FOOTPRINT\*



SC-88/SC70-6/SOT-363

\*For additional information on our Pb-Free strategy and soldering details, please download the ON Semiconductor Soldering and Mounting Techniques Reference Manual, SOLDERRM/D.

ON Semiconductor and are registered trademarks of Semiconductor Components Industries, LLC (SCILLC). SCILLC owns the rights to a number of patents, trademarks, copyrights, trade secrets, and other intellectual property. A listing of SCILLC's product/patent coverage may be accessed at [www.onsemi.com/site/pdf/Patent-Marking.pdf](http://www.onsemi.com/site/pdf/Patent-Marking.pdf). SCILLC reserves the right to make changes without further notice to any products herein. SCILLC makes no warranty, representation or guarantee regarding the suitability of its products for any particular purpose, nor does SCILLC assume any liability arising out of the application or use of any product or circuit, and specifically disclaims any and all liability, including without limitation special, consequential or incidental damages. "Typical" parameters which may be provided in SCILLC data sheets and/or specifications can and do vary in different applications and actual performance may vary over time. All operating parameters, including "Typicals" must be validated for each customer application by customer's technical experts. SCILLC does not convey any license under its patent rights nor the rights of others. SCILLC products are not designed, intended, or authorized for use as components in systems intended for surgical implant into the body, or other applications intended to support or sustain life, or for any other application in which the failure of the SCILLC product could create a situation where personal injury or death may occur. Should Buyer purchase or use SCILLC products for any such unintended or unauthorized application, Buyer shall indemnify and hold SCILLC and its officers, employees, subsidiaries, affiliates, and distributors harmless against all claims, costs, damages, and expenses, and reasonable attorney fees arising out of, directly or indirectly, any claim of personal injury or death associated with such unintended or unauthorized use, even if such claim alleges that SCILLC was negligent regarding the design or manufacture of the part. SCILLC is an Equal Opportunity/Affirmative Action Employer. This literature is subject to all applicable copyright laws and is not for resale in any manner.

### PUBLICATION ORDERING INFORMATION

**LITERATURE FULFILLMENT:**  
Literature Distribution Center for ON Semiconductor  
P.O. Box 5163, Denver, Colorado 80217 USA  
**Phone:** 303-675-2175 or 800-344-3860 Toll Free USA/Canada  
**Fax:** 303-675-2176 or 800-344-3867 Toll Free USA/Canada  
**Email:** [orderlit@onsemi.com](mailto:orderlit@onsemi.com)

**N. American Technical Support:** 800-282-9855 Toll Free  
USA/Canada  
**Europe, Middle East and Africa Technical Support:**  
Phone: 421 33 790 2910  
**Japan Customer Focus Center**  
Phone: 81-3-5817-1050

**ON Semiconductor Website:** [www.onsemi.com](http://www.onsemi.com)  
**Order Literature:** <http://www.onsemi.com/orderlit>  
For additional information, please contact your local Sales Representative

BC846BPDW1T1/D



**Стандарт  
Электрон  
Связь**

Мы молодая и активно развивающаяся компания в области поставок электронных компонентов. Мы поставляем электронные компоненты отечественного и импортного производства напрямую от производителей и с крупнейших складов мира.

Благодаря сотрудничеству с мировыми поставщиками мы осуществляем комплексные и плановые поставки широчайшего спектра электронных компонентов.

Собственная эффективная логистика и склад в обеспечивает надежную поставку продукции в точно указанные сроки по всей России.

Мы осуществляем техническую поддержку нашим клиентам и предпродажную проверку качества продукции. На все поставляемые продукты мы предоставляем гарантию .

Осуществляем поставки продукции под контролем ВП МО РФ на предприятия военно-промышленного комплекса России , а также работаем в рамках 275 ФЗ с открытием отдельных счетов в уполномоченном банке. Система менеджмента качества компании соответствует требованиям ГОСТ ISO 9001.

Минимальные сроки поставки, гибкие цены, неограниченный ассортимент и индивидуальный подход к клиентам являются основой для выстраивания долгосрочного и эффективного сотрудничества с предприятиями радиоэлектронной промышленности, предприятиями ВПК и научно-исследовательскими институтами России.

С нами вы становитесь еще успешнее!

**Наши контакты:**

**Телефон:** +7 812 627 14 35

**Электронная почта:** [sales@st-electron.ru](mailto:sales@st-electron.ru)

**Адрес:** 198099, Санкт-Петербург,  
Промышленная ул, дом № 19, литера Н,  
помещение 100-Н Офис 331