

# 3 Series Thumbwheel Switches

## Features/Benefits

- Most complete product offering in the industry
- Spacers available to fit most panel cutouts
- Front or rear mounting options

## Typical Applications

- Test & measurement equipment
- Industrial equipment
- Computer devices



## Specifications

### CONTACT RATING:

CARRY: 1 AMP continuous.  
SWITCH: 100 mA max.

OPERATING VOLTAGE: 50 mV to 28 V DC or 120 V AC.

ELECTRICAL LIFE: 100,000 actuations.

CONTACT RESISTANCE: Below 100 m Ω typ. initial @  
2-4 V DC, 100 mA.

INSULATION RESISTANCE: 10<sup>9</sup> Ω min.

DIELECTRIC STRENGTH: 500 Vrms min. @ sea level  
between common terminal and any output.

OPERATING TEMPERATURE: -40°C to 65°C.

## Materials

HOUSING: ABS plastic.

THUMBWHEEL: ABS plastic.

ROTOR CONTACTS: Precious metal on copper alloy.

STATOR CONTACTS: Hard gold over nickel over copper  
on epoxy fiberglass.

**NOTE:** Specifications and materials listed above are for switches with standard options. For information on specific and custom switches, consult Customer Service Center.

\* Note: All models listed are RoHS compliant. See Technical Data section of this catalog for RoHS compliant and compatible definitions and specifications.

## Build-A-Switch

To order, simply select desired option from each category and place in the appropriate box. Available options are shown and described on pages M-4 thru M-10. For additional options not shown in catalog, consult Customer Service Center.

Consult factory for illumination availability.

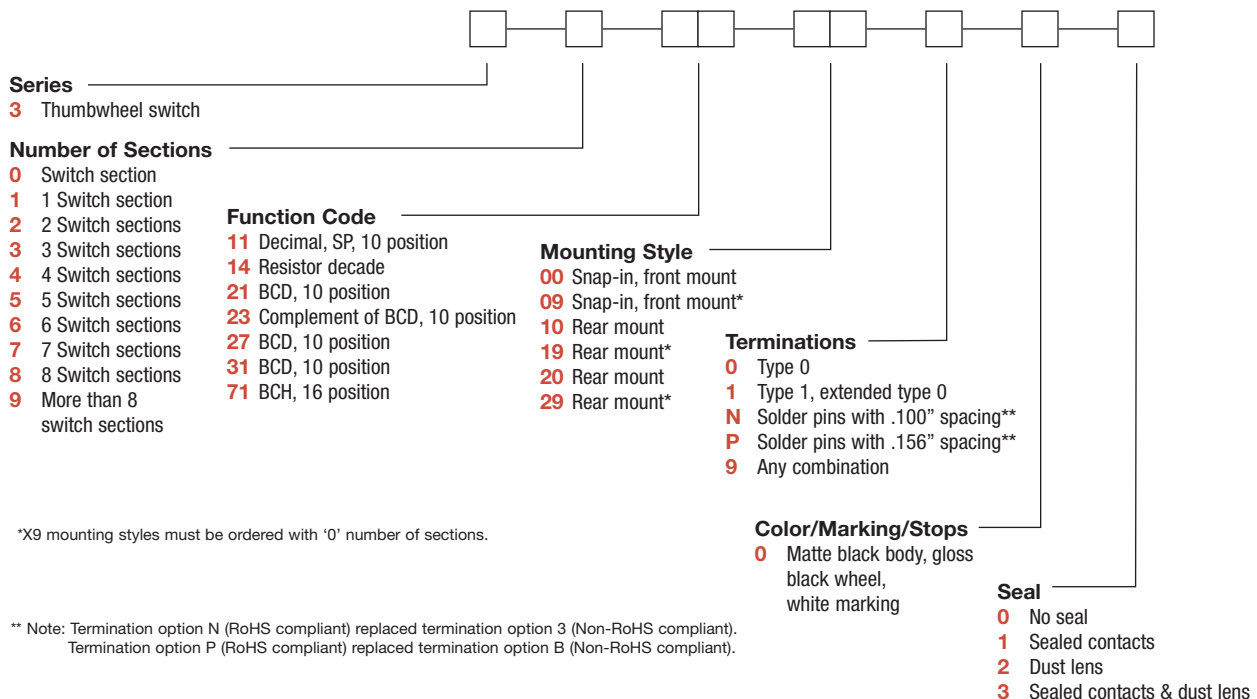

Thumbwheel



M

# 3 Series Thumbwheel Switches

## SERIES

### 3 THUMBWHEEL SWITCHES

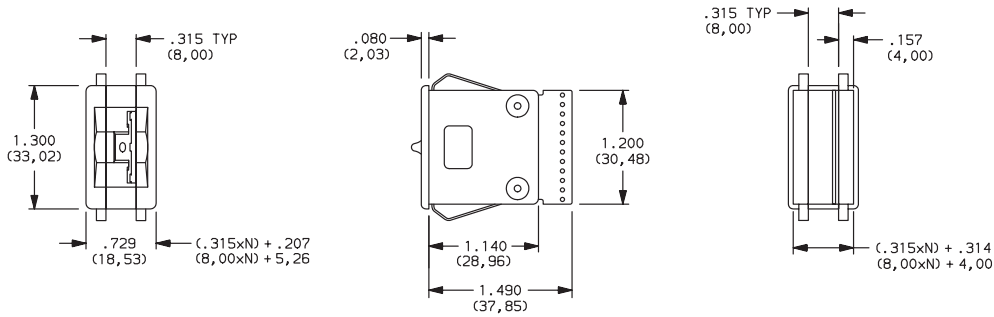

## NUMBER OF SECTIONS

- 0** Switch section only, no assembly. Blank bodies are considered sections; endplates are not sections. Must be ordered with 09 or 19 mounting style options, see pages M-5 and M-6.
- 1-8** Number of switch sections in assembly, includes endplates.
- 9** More than 8 switch sections, specify on CONFIGURATION FORM, page M-10 and consult Customer Service Center.

**NOTE:** Endplates and blank sections available separately, see pages M-13 and M-14.

## FUNCTION CODE

**11** DECIMAL-1 POLE; 10 POSITION

**14** RESISTOR DECADE; 1-2-2-2-2 CODE  
(RESISTORS NOT SUPPLIED)

**21** BCD 1-2-4-8; 10 POSITION

WHEEL	SIGNALS CONNECTED TO COMMON SIGNAL C										
	0	1	2	3	4	5	6	7	8	9	C
0	●										●
1		●									●
2			●								●
3				●							●
4					●						●
5						●					●
6							●				●
7								●			●
8									●		●
9										●	●
	2	3	4	5	6	7	8	9	10	11	12
	TERM. LOCATION										

Available Terminations: 0, 1, N  
See fig. 1, page M-7.

WHEEL	SWITCH CIRCUIT									
	0	1	2	3	4	5	6	7	8	9
0	●									●
1	●	●								●
2	●	●	●							●
3	●	●	●	●						●
4	●	●	●	●	●					●
5	●	●	●	●	●	●				●
6	●	●	●	●	●	●	●			●
7	●	●	●	●	●	●	●	●		●
8	●	●	●	●	●	●	●	●	●	●
9	●	●	●	●	●	●	●	●	●	●
	11	9	7	5	3	1,2	12			
	TERM. LOCATION									

Available Terminations: 1  
See fig. 1, page M-7.

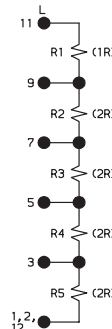

WHEEL	SIGNALS CONN. TO COMM. SIG. C				
	1	2	4	8	C
0					●
1	●				●
2		●			●
3	●	●			●
4			●		●
5	●		●		●
6		●	●		●
7	●	●	●		●
8				●	●
9	●			●	●
	3	5	7	11	9
	TERM. LOCATION				

Available Terminations: 0, 1, N  
See fig. 1, page M-7.

**NOTE:** For terminal location diagram, see page M-7.



Dimensions are shown: Inches (mm)  
Specifications and dimensions subject to change



# 3 Series Thumbwheel Switches

## FUNCTION CODE

**23** COMPLEMENT OF BCD 1-2-4-8;  
10 POSITION

W H E E L	SIGNALS CONN. TO			
	1	2	4	8
0	●	●	●	●
1	●	●	●	●
2	●	●	●	●
3	●	●	●	●
4	●	●	●	●
5	●	●	●	●
6	●	●	●	●
7	●	●	●	●
8	●	●	●	●
9	●	●	●	●
	3	9	11	5
	TERM. LOCATION			

Available Terminations: 0, 1, N  
See fig. 1, page M-7.

**27** BCD 1-2-4-8; 10 POSITION

W H E E L	SIGNALS CONN. TO			
	1	2	4	8
0				
1	●			
2	●	●		
3	●	●	●	
4	●	●	●	●
5	●	●	●	●
6	●	●	●	●
7	●	●	●	●
8	●	●	●	●
9	●	●	●	●
	4	5	1	2
	TERM. LOCATION			

Available Terminations: P  
See fig. 2, page M-7.

**31** BCD 1-2-4-8; 10 POSITION

W H E E L	SIGNALS CONN. TO			
	1	2	4	8
0				
1	●			
2	●	●		
3	●	●	●	
4	●	●	●	●
5	●	●	●	●
6	●	●	●	●
7	●	●	●	●
8	●	●	●	●
9	●	●	●	●
	2	3	11	9
	TERM. LOCATION			

Available Terminations: 0, 1, N  
See fig. 1, page M-7.

**71** BINARY CODED HEXADECIMAL,  
16 POSITION

W H E E L	SIGNALS CONN. TO			
	1	2	4	8
0				
1	●			
2	●	●		
3	●	●	●	
4	●	●	●	●
5	●	●	●	●
6	●	●	●	●
7	●	●	●	●
8	●	●	●	●
9	●	●	●	●
A	●	●	●	●
B	●	●	●	●
C	●	●	●	●
D	●	●	●	●
E	●	●	●	●
F	●	●	●	●
	3	5	7	11
	TERM. LOCATION			

Available Terminations: 0, 1, N  
See fig. 1, page M-7.

**NOTE:** For terminal location diagram, see page M-7.

## MOUNTING STYLE

### Type 0 Snap-In Front Mount

MOUNTING STYLE	DIM. 'A'
00	(.315 x N) + .326 (8,00 x N) + (8,28)

N = Number of sections.

Recommended panel thickness:  
0.46-.125  
(1,16-3,18)

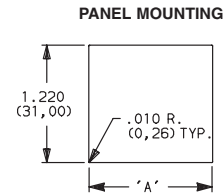

**00** SWITCH ASSEMBLY W/ ENDPLATES-.315 (8,00) SECTION PITCH

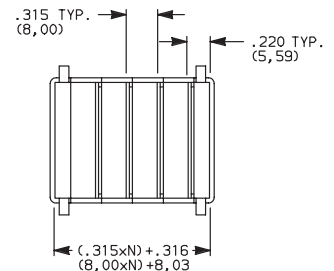
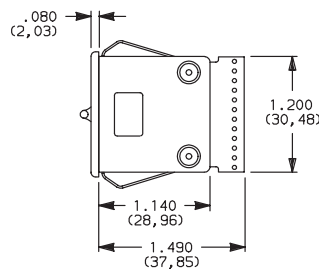
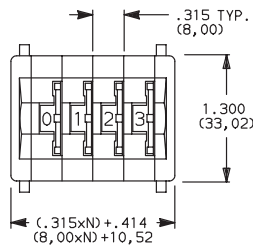

N = Number of sections.

**09** SWITCH SECTION ONLY-UNASSEMBLED WITHOUT ENDPLATES OR SPACERS  
(Must be ordered with number of sections option "0", see Page M-4.)

**NOTE:** Endplates, blank sections, spacers  
and assembly hardware available separately, see pages M-8 and M-9.



Dimensions are shown: Inches (mm)  
Specifications and dimensions subject to change



# 3 Series Thumbwheel Switches

## MOUNTING STYLE

### Type 1 Rear Mount

MOUNTING STYLE	DIM. 'A'	DIM. 'B'
10	$(.350 \times N) + .340$ $(8,89 \times N) + (8,64)$	$(.350 \times N) + .560$ $(8,89 \times N) + (14,22)$

N = Number of sections.

Recommended panel thickness:  
0.46-.125  
(1,16-3,18)

### PANEL MOUNTING

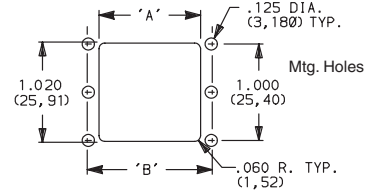

### 10 SWITCH ASSEMBLY W/ ENDPLATES-.350 (8,89) SECTION PITCH

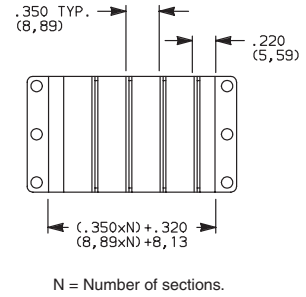
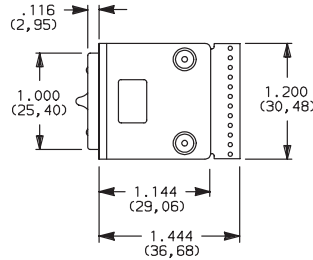
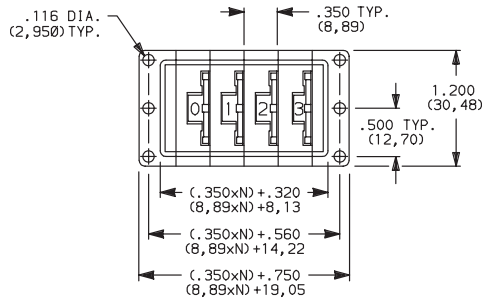

N = Number of sections.

### 19 SWITCH SECTION ONLY-UNASSEMBLED WITHOUT ENDPLATES OR SPACERS (Must be ordered with number of sections option "0", see Page M-4.)

### Type 2 Rear Mount

### 20 SWITCH ASSEMBLY W/ ENDPLATES-.350 (8,89) SECTION PITCH

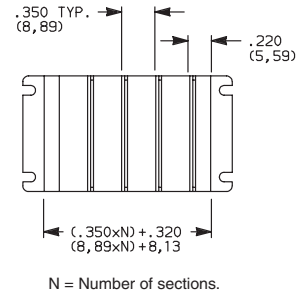
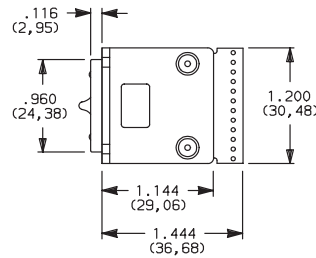
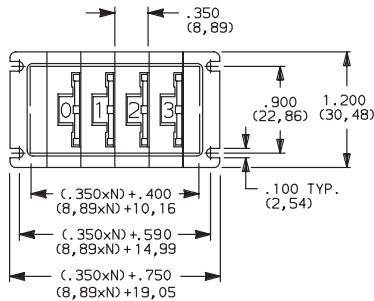

N = Number of sections.

### 29 SWITCH SECTION ONLY-UNASSEMBLED WITHOUT ENDPLATES OR SPACERS (Must be ordered with number of sections option "0", see Page M-4.)

Thumbwheel



M

**NOTE:** Endplates, blank sections, spacers and assembly hardware available separately, see pages M-8 and M-9.



Third Angle  
Projection

Dimensions are shown: Inches (mm)

Specifications and dimensions subject to change



# 3 Series Thumbwheel Switches

## TERMINATIONS

### 0 TYPE 0

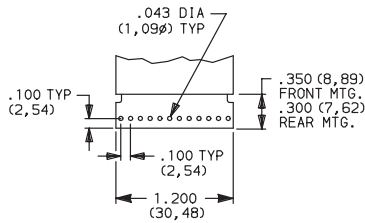

### 1 TYPE 1, EXTENDED TYPE 0

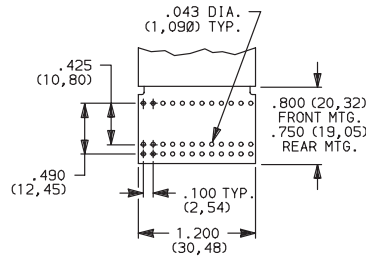

Signal traces cut except for common(s).

### N SOLDER PINS WITH .100" SPACING

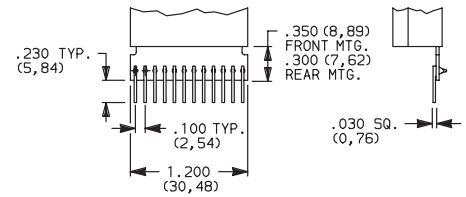

### 9 ANY COMBINATION OF TERMINATION CONFIGURATIONS OR SPECIAL TERMINATIONS.

Specify on configuration form, page M-10 and consult Customer Service Center.

### P SOLDER PINS WITH .156" SPACING

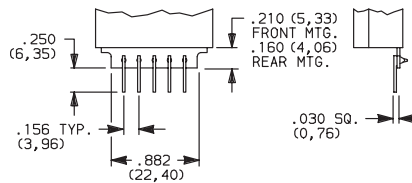

PC Board 1/32" (0,79) thick.

**NOTE:** All terminal holes shown may not be present for all function codes, consult Customer Service Center. Terminal connector available for termination options 0 & 1, see page M-9.

**NOTE:** Termination option N (RoHS compliant) replaced termination option 3 (Non-RoHS compliant). Termination option P (RoHS compliant) replaced termination option B (Non-RoHS compliant).

## Terminal Location Numbers

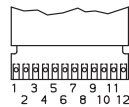

FIG. 1

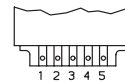

FIG. 2



**NOTE:** See function codes, pages M-4 and M-5, for signal locations.

## COLOR/MARKING/STOPS

### 0 MATTE BLACK HOUSING (Gloss black wheel with white characters; no stops.)

**NOTE:** Stop pins are available separately, see page M-8.

## SEAL

### 0 UNSEALED SWITCHING CONTACTS.

**1 SEALED SWITCHING CONTACTS.** (Sealing is by means of an o-ring rotary seal and a cured-in-place elastomer gasket. Switching contact area is protected from moisture, oil, and airborne contaminants.)

**2 DUST LENS.** (Protects the character face of the wheel from abrasion and dirt).

**3 SEALED SWITCHING CONTACTS AND DUST LENS**

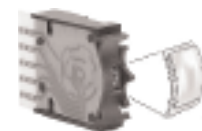

Dust Lens



Third Angle Projection  
Dimensions are shown: Inches (mm)  
Specifications and dimensions subject to change



# 3 Series Thumbwheel Switches

## AVAILABLE HARDWARE

Blank sections, Type 0,  
.315 THK.



**PART NO.**  
**413602000** W/RIB-BLACK  
**400502000** W/RIB & W/OUT SPRINGS-BLACK

Blank sections, Front mount, Type 0,  
.315 THK.



**PART NO.**  
**413502000** PLAIN-BLACK  
**400702000** PLAIN & W/OUT SPRINGS-BLACK

Blank sections, Rear mount, Type 1,  
.350 THK.



4006                      4008

**PART NO.**  
**400602000** W/RIB-BLACK  
**400802000** PLAIN-BLACK

Blank sections, Rear mount, Type 2,  
.350 THK.



4734                      4733

**PART NO.**  
**473402000** W/RIB-BLACK  
**473302000** PLAIN-BLACK

End plates, Front mount, Type 0



**PART NO.**  
**413402000** BLACK  
 Two required for complete assembly.

End plates, Rear mount, Type 1



**PART NO.**  
**400402003** BLACK  
 Two required for complete assembly.

End plates, Rear mount, Type 2



**PART NO.**  
**473202003** BLACK  
 Two required for complete assembly.

Spacers, Front mount, Type 0 & 3, .078 THK.  
(Makes section pitch 10mm)



**PART NO.**  
**410802000** BLACK

Stop pins



**PART NO.**  
**402900000**

Thumbwheel



M



Dimensions are shown: Inches (mm)  
 Specifications and dimensions subject to change

# 3 Series Thumbwheel Switches

## AVAILABLE HARDWARE

Terminal connector

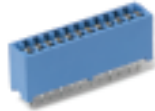

605A00000



605A02000

PART NO.

605A00000 PC

605A02000 SOLDER LUG

Fits 0 & 1 terminations only.

Screws for field assembly of thumbwheel switches  
(2 screws needed per assembly + 403500000 nuts)

SCREW PART NUMBER (0-80 UNF THD. SIZE)	NUMBER OF SECTIONS IN ASSEMBLY	
	FRONT MOUNTING	REAR MOUNTING
	MTG. STYLE - 00	MTG. STYLE - 10
412700000	1-2	1-2
412701000	3-4	3
412702000	5-7	4-6

Nut



Two nuts required per assembly and screws.

PART NO.

403500000

Nut driver (For 403500000 nut)



PART NO.

406100652

Thumbwheel



M

# 3 Series Thumbwheel Switches

## Configuration Form

GRAY SHADED AREAS TO BE FILLED IN BY CUSTOMER SERVICE.

CATALOG PART NO.

**3**











C&K PART NUMBER

C&K PART NUMBER

COMPANY NAME \_\_\_\_\_  
 ADDRESS \_\_\_\_\_ TEL.# \_\_\_\_\_  
 CUSTOMER CONTACT \_\_\_\_\_ DATE \_\_\_\_\_  
 ORIGINATED BY \_\_\_\_\_ SALES REP. \_\_\_\_\_

CUSTOMER PRINT REVISION:

DETAILS:

THUMBWHEEL SECTIONS	NO. OF SEC.	FUNCTION CODE – TERMINATIONS – COLOR/MARKING/STOPS/SEAL – ILLUMINATION <small>ENTER OPTION CODES IN APPROPRIATE BOXES. FUNCTION CODES INCLUDE BLANK SECTIONS (SEE PAGES M-9 &amp; M-10).</small>	DESCRIBE IN APPROPRIATE ROW
	1	<input type="text"/> 3 - <input type="text"/> <input type="text"/> - - <input type="text"/> <input type="text"/> <input type="text"/> <input type="text"/>	
	2	<input type="text"/> 3 - <input type="text"/> <input type="text"/> - - <input type="text"/> <input type="text"/> <input type="text"/> <input type="text"/>	
	3	<input type="text"/> 3 - <input type="text"/> <input type="text"/> - - <input type="text"/> <input type="text"/> <input type="text"/> <input type="text"/>	
	4	<input type="text"/> 3 - <input type="text"/> <input type="text"/> - - <input type="text"/> <input type="text"/> <input type="text"/> <input type="text"/>	
	5	<input type="text"/> 3 - <input type="text"/> <input type="text"/> - - <input type="text"/> <input type="text"/> <input type="text"/> <input type="text"/>	
	6	<input type="text"/> 3 - <input type="text"/> <input type="text"/> - - <input type="text"/> <input type="text"/> <input type="text"/> <input type="text"/>	
	7	<input type="text"/> 3 - <input type="text"/> <input type="text"/> - - <input type="text"/> <input type="text"/> <input type="text"/> <input type="text"/>	
	8	<input type="text"/> 3 - <input type="text"/> <input type="text"/> - - <input type="text"/> <input type="text"/> <input type="text"/> <input type="text"/>	
	9	<input type="text"/> 3 - <input type="text"/> <input type="text"/> - - <input type="text"/> <input type="text"/> <input type="text"/> <input type="text"/>	
	10	<input type="text"/> 3 - <input type="text"/> <input type="text"/> - - <input type="text"/> <input type="text"/> <input type="text"/> <input type="text"/>	
	11	<input type="text"/> 3 - <input type="text"/> <input type="text"/> - - <input type="text"/> <input type="text"/> <input type="text"/> <input type="text"/>	

Thumbwheel



M

QUALITY CONTROL INSTRUCTIONS

PRODUCTION APPROVAL DATE

Q.C. APPROVAL DATE

REV. INITIALS DATE

FOR SWITCHES WITH MORE THAN 11 SECTIONS, CONTINUE ON ADDITIONAL SHEETS.

SPECIAL INSTRUCTIONS OR SPECIFICATIONS:

SHEET \_\_\_\_ OF \_\_\_\_



Dimensions are shown: Inches (mm)  
Specifications and dimensions subject to change





## Стандарт Электрон Связь

Мы молодая и активно развивающаяся компания в области поставок электронных компонентов. Мы поставляем электронные компоненты отечественного и импортного производства напрямую от производителей и с крупнейших складов мира.

Благодаря сотрудничеству с мировыми поставщиками мы осуществляем комплексные и плановые поставки широчайшего спектра электронных компонентов.

Собственная эффективная логистика и склад в обеспечивает надежную поставку продукции в точно указанные сроки по всей России.

Мы осуществляем техническую поддержку нашим клиентам и предпродажную проверку качества продукции. На все поставляемые продукты мы предоставляем гарантию .

Осуществляем поставки продукции под контролем ВП МО РФ на предприятия военно-промышленного комплекса России , а также работаем в рамках 275 ФЗ с открытием отдельных счетов в уполномоченном банке. Система менеджмента качества компании соответствует требованиям ГОСТ ISO 9001.

Минимальные сроки поставки, гибкие цены, неограниченный ассортимент и индивидуальный подход к клиентам являются основой для выстраивания долгосрочного и эффективного сотрудничества с предприятиями радиоэлектронной промышленности, предприятиями ВПК и научно-исследовательскими институтами России.

С нами вы становитесь еще успешнее!

### Наши контакты:

**Телефон:** +7 812 627 14 35

**Электронная почта:** [sales@st-electron.ru](mailto:sales@st-electron.ru)

**Адрес:** 198099, Санкт-Петербург,  
Промышленная ул, дом № 19, литера Н,  
помещение 100-Н Офис 331