

NTR0202PL

Power MOSFET

-20 V, -400 mA, P-Channel
SOT-23 Package



ON Semiconductor®

<http://onsemi.com>

Features

- Low $R_{DS(on)}$ Provides Higher Efficiency and Extends Battery Life
 $R_{DS(on)} = 0.80 \Omega$, $V_{GS} = -10$ V
 $R_{DS(on)} = 1.10 \Omega$, $V_{GS} = -4.5$ V
- Miniature SOT-23 Surface Mount Package Saves Board Space
- Pb-Free Packages are Available

Applications

- DC-DC Converters
- Computers
- Printers
- PCMCIA Cards
- Cellular and Cordless Telephones

MAXIMUM RATINGS ($T_J = 25^\circ\text{C}$ unless otherwise noted)

Rating	Symbol	Value	Unit
Drain-to-Source Voltage	V_{DSS}	-20	V
Gate-to-Source Voltage - Continuous	V_{GS}	± 20	V
Continuous Drain Current @ $T_A = 25^\circ\text{C}$ Pulsed Drain Current ($t_p \leq 10 \mu\text{s}$)	I_D I_{DM}	-0.4 -1.0	A
Total Power Dissipation @ $T_A = 25^\circ\text{C}$ (Note 1)	P_D	225	mW
Operating and Storage Temperature Range	T_J, T_{stg}	-55 to 150	$^\circ\text{C}$
Thermal Resistance - Junction-to-Ambient	$R_{\theta JA}$	556	$^\circ\text{C}/\text{W}$
Source Current (Body Diode)	I_S	0.4	A
Maximum Lead Temperature for Soldering Purposes, 1/8" from case for 10 s	T_L	260	$^\circ\text{C}$

Stresses exceeding Maximum Ratings may damage the device. Maximum Ratings are stress ratings only. Functional operation above the Recommended Operating Conditions is not implied. Extended exposure to stresses above the Recommended Operating Conditions may affect device reliability.

1. Pulse Test: Pulse Width $\leq 300 \mu\text{s}$, Duty Cycle $\leq 2\%$.

$V_{(BR)DSS}$	$R_{DS(on)}$ Typ	I_D MAX
-20 V	550 m Ω @ -10 V	-400 mA

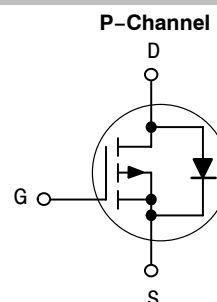

MARKING DIAGRAM & PIN ASSIGNMENT

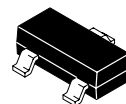

SOT-23
CASE 318
STYLE 21

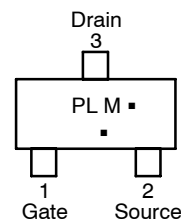

PL = Specific Device Code
M = Date Code*
▪ = Pb-Free Package

(Note: Microdot may be in either location)
*Date Code orientation may vary depending upon manufacturing location.

ORDERING INFORMATION

Device	Package	Shipping†
NTR0202PLT1	SOT-23	3000 Tape & Reel
NTR0202PLT1G	SOT-23 (Pb-Free)	3000 Tape & Reel
NTR0202PLT3	SOT-23	10,000 Tape & Reel
NTR0202PLT3G	SOT-23 (Pb-Free)	10,000 Tape & Reel

†For information on tape and reel specifications, including part orientation and tape sizes, please refer to our Tape and Reel Packaging Specification Brochure, BRD8011/D.

NTR0202PL

ELECTRICAL CHARACTERISTICS ($T_A = 25^\circ\text{C}$ unless otherwise noted)

Characteristic	Symbol	Min	Typ	Max	Unit
OFF CHARACTERISTICS					
Drain-to-Source Breakdown Voltage ($V_{GS} = 0\text{ V}$, $I_D = -10\ \mu\text{A}$) (Positive Temperature Coefficient)	$V_{(BR)DSS}$	-20	33		V mV/ $^\circ\text{C}$
Zero Gate Voltage Drain Current ($V_{DS} = -20\text{ V}$, $V_{GS} = 0\text{ V}$, $T_J = 25^\circ\text{C}$) ($V_{DS} = -20\text{ V}$, $V_{GS} = 0\text{ V}$, $T_J = 150^\circ\text{C}$)	I_{DSS}			-1.0 -10	μA
Gate-Body Leakage Current ($V_{GS} = \pm 20\text{ V}$, $V_{DS} = 0\text{ V}$)	I_{GSS}			± 100	nA
ON CHARACTERISTICS (Note 2)					
Gate Threshold Voltage ($V_{DS} = V_{GS}$, $I_D = -250\ \mu\text{A}$) (Negative Temperature Coefficient)	$V_{GS(th)}$	-1.1	-1.9 3.0	-2.3	V mV/ $^\circ\text{C}$
Static Drain-to-Source On-Resistance ($V_{GS} = -10\text{ V}$, $I_D = -200\text{ mA}$) ($V_{GS} = -4.5\text{ V}$, $I_D = -50\text{ mA}$)	$R_{DS(on)}$		0.55 0.80	0.80 1.10	Ω
Forward Transconductance ($V_{DS} = -10\text{ V}$, $I_D = -200\text{ mA}$)	g_{fs}		0.5		Mhos
DYNAMIC CHARACTERISTICS					
Input Capacitance	$(V_{DS} = -5.0\text{ V}$, $V_{GS} = 0\text{ V}$, $F = 1.0\text{ MHz}$)	C_{iss}	70		pF
Output Capacitance		C_{oss}	74		
Reverse Transfer Capacitance		C_{rss}	26		
SWITCHING CHARACTERISTICS (Note 3)					
Turn-On Delay Time	$(V_{DD} = -15\text{ V}$, $I_D = -200\text{ mA}$, $V_{GS} = -10\text{ V}$, $R_G = 6.0\ \Omega$)	$t_{d(on)}$	3.0		ns
Rise Time		t_r	6.0		
Turn-Off Delay Time		$t_{d(off)}$	18		
Fall Time		t_f	4		
Total Gate Charge	$(V_{DS} = -15\text{ V}$, $I_D = -200\text{ mA}$, $V_{GS} = -10\text{ V}$)	Q_{TOT}	2.18		nC
Gate-Source Charge		Q_{GS}	0.41		
Gate-Drain Charge		Q_{GD}	0.40		
BODY-DRAIN DIODE CHARACTERISTICS (Note 2)					
Diode Forward Voltage (Note 2) ($I_S = -400\text{ mA}$, $V_{GS} = 0\text{ V}$) ($I_S = -400\text{ mA}$, $V_{GS} = 0\text{ V}$, $T_J = 150^\circ\text{C}$)	V_{SD}		-0.8 -0.65	-1.0	V
Reverse Recovery Time	$(I_S = -1.0\text{ A}$, $V_{GS} = 0\text{ V}$, $di_S/dt = 100\text{ A}/\mu\text{s}$)	t_{rr}	11.8		ns
		t_a	9		
		t_b	3		
Reverse Recovery Stored Charge	$(I_S = -1.0\text{ A}$, $V_{GS} = 0\text{ V}$, $di_S/dt = 100\text{ A}/\mu\text{s}$)	Q_{RR}	0.007		μC

2. Pulse Test: Pulse Width $\leq 300\ \mu\text{s}$, Duty Cycle $\leq 2\%$.
3. Switching characteristics are independent of operating junction temperature.

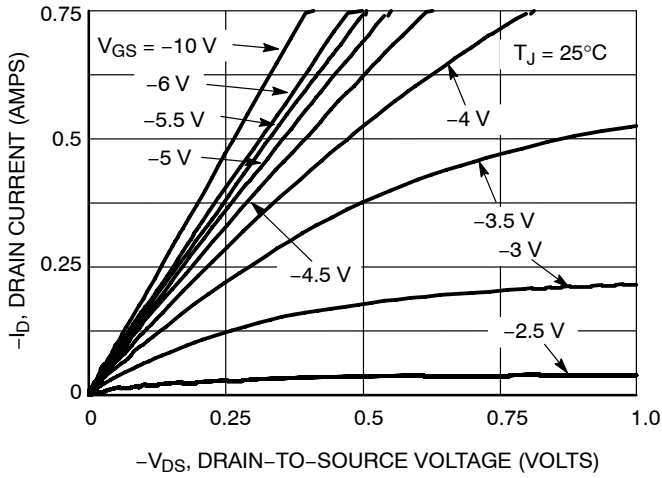

Figure 1. On-Region Characteristics

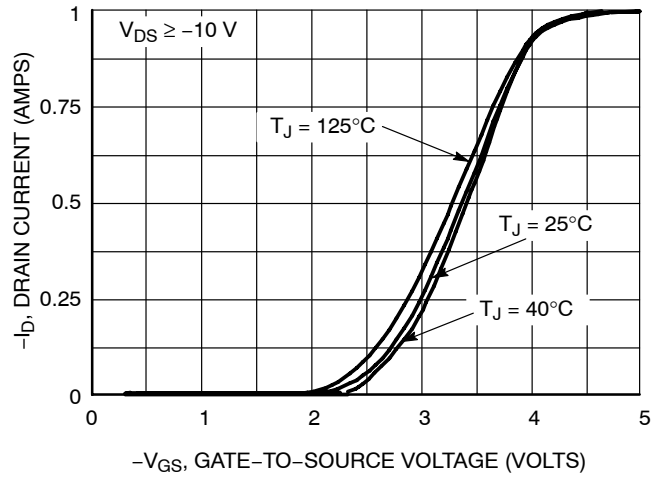

Figure 2. Transfer Characteristics

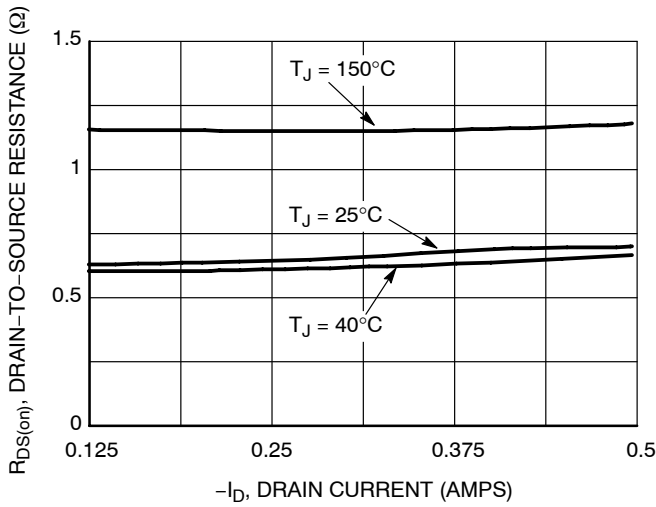

Figure 3. On-Resistance versus Drain Current

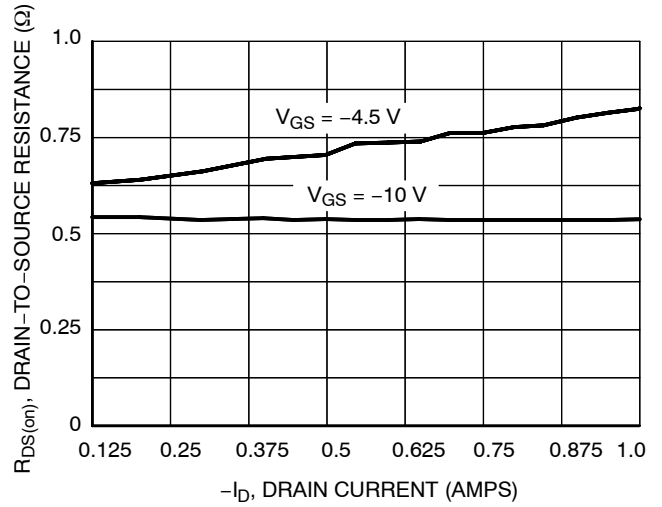

Figure 4. On-Resistance versus Drain Current and Gate Voltage

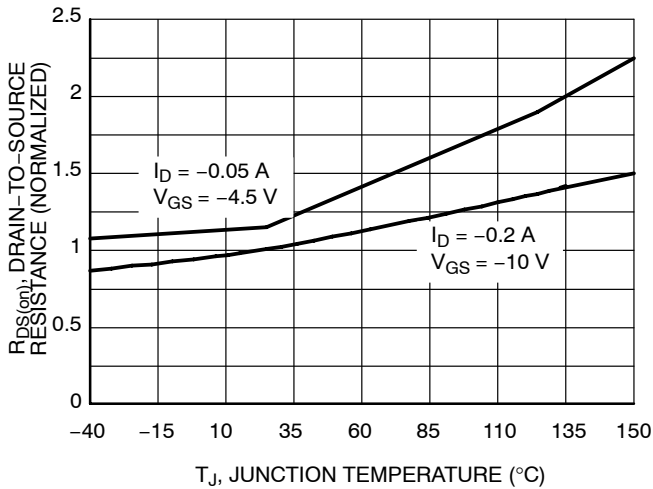

Figure 5. On-Resistance Variation with Temperature

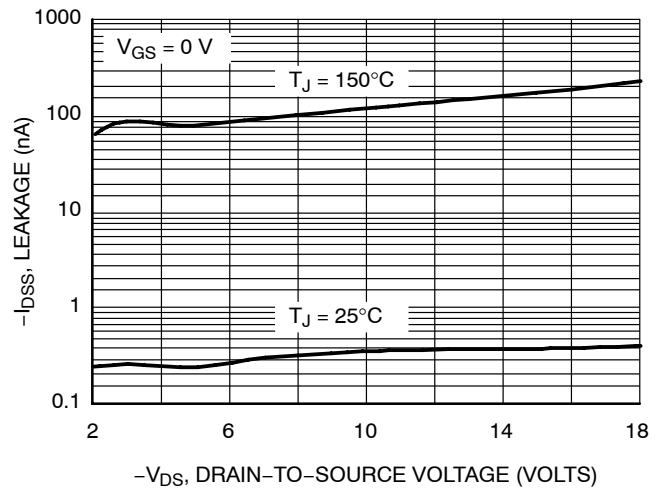

Figure 6. Drain-to-Source Leakage Current versus Voltage

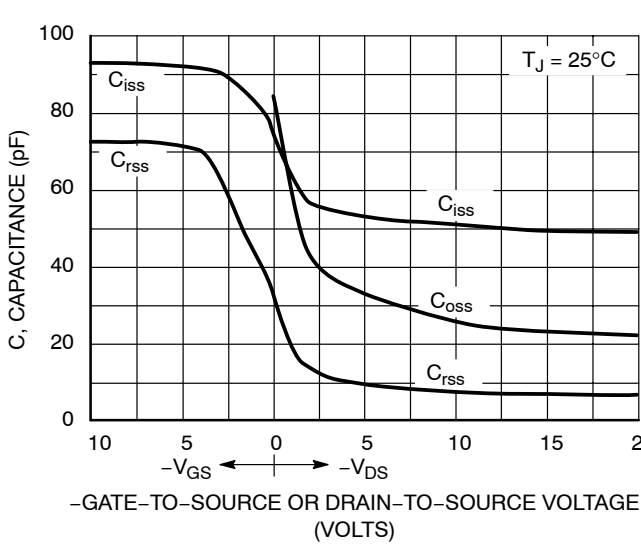

Figure 7. Capacitance Variation

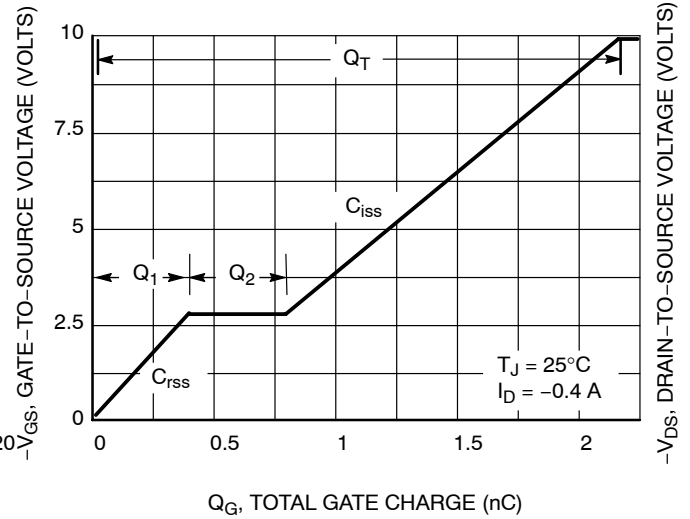

Figure 8. Gate-to-Source and Drain-to-Source Voltage versus Total Gate Charge

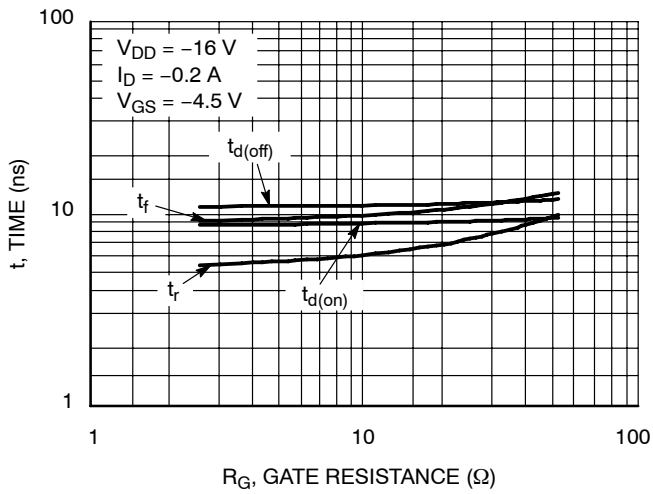

Figure 9. Resistive Switching Time Variation versus Gate Resistance

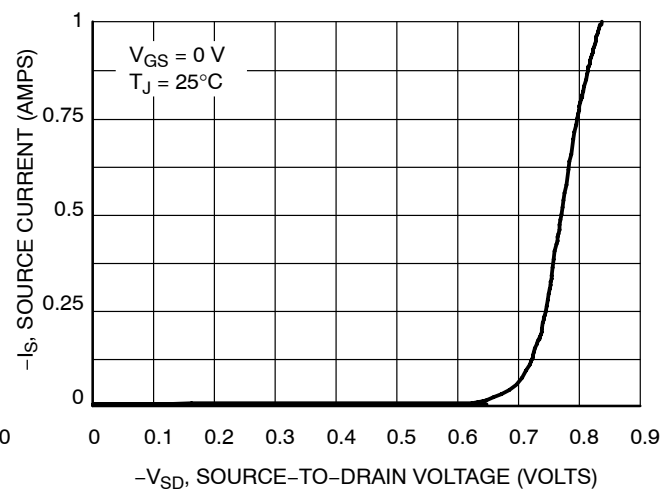
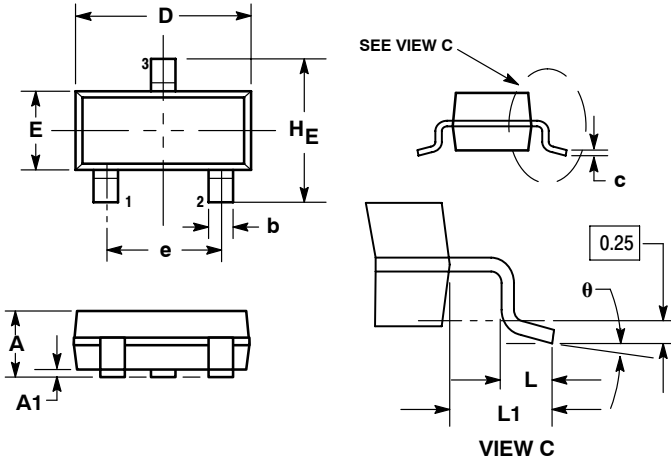

Figure 10. Diode Forward Voltage versus Current

NTR0202PL

PACKAGE DIMENSIONS

SOT-23 (TO-236) CASE 318-08 ISSUE AN



- NOTES:
1. DIMENSIONING AND TOLERANCING PER ANSI Y14.5M, 1982.
 2. CONTROLLING DIMENSION: INCH.
 3. MAXIMUM LEAD THICKNESS INCLUDES LEAD FINISH THICKNESS. MINIMUM LEAD THICKNESS IS THE MINIMUM THICKNESS OF BASE MATERIAL.
 4. 318-01 THRU -07 AND -09 OBSOLETE, NEW STANDARD 318-08.

DIM	MILLIMETERS			INCHES		
	MIN	NOM	MAX	MIN	NOM	MAX
A	0.89	1.00	1.11	0.035	0.040	0.044
A1	0.01	0.06	0.10	0.001	0.002	0.004
b	0.37	0.44	0.50	0.015	0.018	0.020
c	0.09	0.13	0.18	0.003	0.005	0.007
D	2.80	2.90	3.04	0.110	0.114	0.120
E	1.20	1.30	1.40	0.047	0.051	0.055
e	1.78	1.90	2.04	0.070	0.075	0.081
L	0.10	0.20	0.30	0.004	0.008	0.012
L1	0.35	0.54	0.69	0.014	0.021	0.029
HE	2.10	2.40	2.64	0.083	0.094	0.104

- STYLE 21:
PIN 1. GATE
2. SOURCE
3. DRAIN

SOLDERING FOOTPRINT*

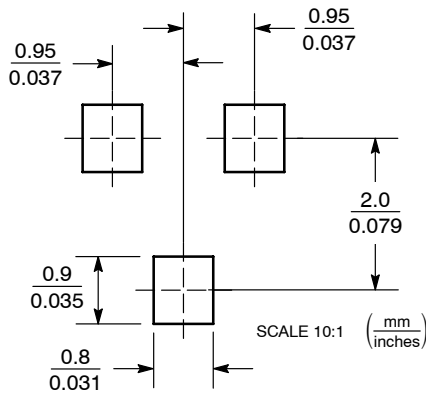

*For additional information on our Pb-Free strategy and soldering details, please download the ON Semiconductor Soldering and Mounting Techniques Reference Manual, SOLDERRM/D.

ON Semiconductor and are registered trademarks of Semiconductor Components Industries, LLC (SCILLC). SCILLC reserves the right to make changes without further notice to any products herein. SCILLC makes no warranty, representation or guarantee regarding the suitability of its products for any particular purpose, nor does SCILLC assume any liability arising out of the application or use of any product or circuit, and specifically disclaims any and all liability, including without limitation special, consequential or incidental damages. "Typical" parameters which may be provided in SCILLC data sheets and/or specifications can and do vary in different applications and actual performance may vary over time. All operating parameters, including "Typicals" must be validated for each customer application by customer's technical experts. SCILLC does not convey any license under its patent rights nor the rights of others. SCILLC products are not designed, intended, or authorized for use as components in systems intended for surgical implant into the body, or other applications intended to support or sustain life, or for any other application in which the failure of the SCILLC product could create a situation where personal injury or death may occur. Should Buyer purchase or use SCILLC products for any such unintended or unauthorized application, Buyer shall indemnify and hold SCILLC and its officers, employees, subsidiaries, affiliates, and distributors harmless against all claims, costs, damages, and expenses, and reasonable attorney fees arising out of, directly or indirectly, any claim of personal injury or death associated with such unintended or unauthorized use, even if such claim alleges that SCILLC was negligent regarding the design or manufacture of the part. SCILLC is an Equal Opportunity/Affirmative Action Employer. This literature is subject to all applicable copyright laws and is not for resale in any manner.

PUBLICATION ORDERING INFORMATION

LITERATURE FULFILLMENT:
Literature Distribution Center for ON Semiconductor
P.O. Box 61312, Phoenix, Arizona 85082-1312 USA
Phone: 480-829-7710 or 800-344-3860 Toll Free USA/Canada
Fax: 480-829-7709 or 800-344-3867 Toll Free USA/Canada
Email: orderlit@onsemi.com

N. American Technical Support: 800-282-9855 Toll Free
USA/Canada

Japan: ON Semiconductor, Japan Customer Focus Center
2-9-1 Kamimeguro, Meguro-ku, Tokyo, Japan 153-0051
Phone: 81-3-5773-3850

ON Semiconductor Website: <http://onsemi.com>

Order Literature: <http://www.onsemi.com/litorder>

For additional information, please contact your local Sales Representative.



Стандарт Электрон Связь

Мы молодая и активно развивающаяся компания в области поставок электронных компонентов. Мы поставляем электронные компоненты отечественного и импортного производства напрямую от производителей и с крупнейших складов мира.

Благодаря сотрудничеству с мировыми поставщиками мы осуществляем комплексные и плановые поставки широчайшего спектра электронных компонентов.

Собственная эффективная логистика и склад в обеспечивает надежную поставку продукции в точно указанные сроки по всей России.

Мы осуществляем техническую поддержку нашим клиентам и предпродажную проверку качества продукции. На все поставляемые продукты мы предоставляем гарантию .

Осуществляем поставки продукции под контролем ВП МО РФ на предприятия военно-промышленного комплекса России , а также работаем в рамках 275 ФЗ с открытием отдельных счетов в уполномоченном банке. Система менеджмента качества компании соответствует требованиям ГОСТ ISO 9001.

Минимальные сроки поставки, гибкие цены, неограниченный ассортимент и индивидуальный подход к клиентам являются основой для выстраивания долгосрочного и эффективного сотрудничества с предприятиями радиоэлектронной промышленности, предприятиями ВПК и научно-исследовательскими институтами России.

С нами вы становитесь еще успешнее!

Наши контакты:

Телефон: +7 812 627 14 35

Электронная почта: sales@st-electron.ru

Адрес: 198099, Санкт-Петербург,
Промышленная ул, дом № 19, литера Н,
помещение 100-Н Офис 331