

NGD15N41CL, NGD15N41ACL, NGB15N41CL, NGB15N41ACL, NGP15N41CL, NGP15N41ACL

Ignition IGBT 15 A, 410 V N-Channel DPAK, D²PAK and TO-220

This Logic Level Insulated Gate Bipolar Transistor (IGBT) features monolithic circuitry integrating ESD and Over-Voltage clamped protection for use in inductive coil drivers applications. Primary uses include Ignition, Direct Fuel Injection, or wherever high voltage and high current switching is required.

Features

- Ideal for Coil-on-Plug Applications
- DPAK Package Offers Smaller Footprint and Increased Board Space
- Gate-Emitter ESD Protection
- Temperature Compensated Gate-Collector Voltage Clamp Limits Stress Applied to Load
- Integrated ESD Diode Protection
- New Design Increases Unclamped Inductive Switching (UIS) Energy Per Area
- Low Threshold Voltage to Interface Power Loads to Logic or Microprocessor Devices
- Low Saturation Voltage
- High Pulsed Current Capability
- Optional Gate Resistor (R_G) and Gate-Emitter Resistor (R_{GE})
- These are Pb-Free Devices

MAXIMUM RATINGS ($T_J = 25^\circ\text{C}$ unless otherwise noted)

Rating	Symbol	Value	Unit
Collector-Emitter Voltage	V_{CES}	440	V_{DC}
Collector-Gate Voltage	V_{CER}	440	V_{DC}
Gate-Emitter Voltage	V_{GE}	15	V_{DC}
Collector Current-Continuous @ $T_C = 25^\circ\text{C}$ - Pulsed	I_C	15 50	A_{DC} A_{AC}
ESD (Human Body Model) $R = 1500 \Omega$, $C = 100 \text{ pF}$	ESD	8.0	kV
ESD (Machine Model) $R = 0 \Omega$, $C = 200 \text{ pF}$	ESD	800	V
Total Power Dissipation @ $T_C = 25^\circ\text{C}$ Derate above 25°C	P_D	107 0.71	Watts $\text{W}/^\circ\text{C}$
Operating and Storage Temperature Range	T_J, T_{stg}	-55 to +175	$^\circ\text{C}$

Stresses exceeding Maximum Ratings may damage the device. Maximum Ratings are stress ratings only. Functional operation above the Recommended Operating Conditions is not implied. Extended exposure to stresses above the Recommended Operating Conditions may affect device reliability.



ON Semiconductor®

<http://onsemi.com>

15 AMPS
410 VOLTS

$V_{CE(on)} \leq 2.1 \text{ V @}$
 $I_C = 10 \text{ A}, V_{GE} \geq 4.5 \text{ V}$

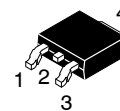
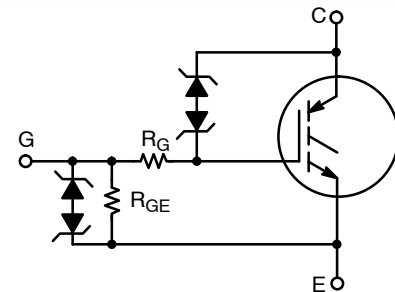

DPAK
CASE 369C
STYLE 2

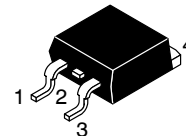

D²PAK
CASE 418B
STYLE 4

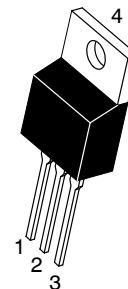

TO-220AB
CASE 221A
STYLE 9

ORDERING INFORMATION

See detailed ordering and shipping information in the package dimensions section on page 8 of this data sheet.

DEVICE MARKING INFORMATION

See general marking information in the device marking section on page 8 of this data sheet.

NGD15N41CL, NGD15N41ACL, NGB15N41CL, NGB15N41ACL, NGP15N41CL, NGP15N41ACL

UNCLAMPED COLLECTOR-TO-EMITTER AVALANCHE CHARACTERISTICS ($-55^{\circ} \leq T_J \leq 175^{\circ}C$)

Characteristic	Symbol	Value	Unit
Single Pulse Collector-to-Emitter Avalanche Energy $V_{CC} = 50\text{ V}$, $V_{GE} = 5.0\text{ V}$, Pk $I_L = 16.6\text{ A}$, $L = 1.8\text{ mH}$, Starting $T_J = 25^{\circ}C$ $V_{CC} = 50\text{ V}$, $V_{GE} = 5.0\text{ V}$, Pk $I_L = 15\text{ A}$, $L = 1.8\text{ mH}$, Starting $T_J = 125^{\circ}C$	E_{AS}	250 200	mJ

THERMAL CHARACTERISTICS

Characteristic	Symbol	Value	Unit
Thermal Resistance, Junction to Case	$R_{\theta JC}$	1.4	$^{\circ}C/W$
Thermal Resistance, Junction to Ambient	DPAK (Note 1) $R_{\theta JA}$	100	
	D ² PAK (Note 1) $R_{\theta JA}$	50	
	TO-220 $R_{\theta JA}$	62.5	
Maximum Lead Temperature for Soldering Purposes, 1/8" from case for 5 seconds	T_L	275	$^{\circ}C$

ELECTRICAL CHARACTERISTICS

Characteristic	Symbol	Test Conditions	Temperature	Min	Typ	Max	Unit
----------------	--------	-----------------	-------------	-----	-----	-----	------

OFF CHARACTERISTICS

Collector-Emitter Clamp Voltage	BV_{CES}	$I_C = 2.0\text{ mA}$	$T_J = -40^{\circ}C$ to $150^{\circ}C$	380	410	440	V_{DC}
		$I_C = 10\text{ mA}$	$T_J = -40^{\circ}C$ to $150^{\circ}C$	380	410	440	
Zero Gate Voltage Collector Current	I_{CES}	$V_{CE} = 350\text{ V}$, $V_{GE} = 0\text{ V}$	$T_J = 25^{\circ}C$	-	2.0	20	μA_{DC}
			$T_J = 150^{\circ}C$	-	10	40*	
			$T_J = -40^{\circ}C$	-	1.0	10	
Reverse Collector-Emitter Leakage Current	I_{ECS}	$V_{CE} = -24\text{ V}$	$T_J = 25^{\circ}C$	-	0.7	2.0	mA
			$T_J = 150^{\circ}C$	-	12	25*	
			$T_J = -40^{\circ}C$	-	0.1	1.0	
Reverse Collector-Emitter Clamp Voltage	$BV_{CES(R)}$	$I_C = -75\text{ mA}$	$T_J = 25^{\circ}C$	27	33	37	V_{DC}
			$T_J = 150^{\circ}C$	30	36	40	
			$T_J = -40^{\circ}C$	25	31	35	
Gate-Emitter Clamp Voltage	BV_{GES}	$I_G = 5.0\text{ mA}$	$T_J = -40^{\circ}C$ to $150^{\circ}C$	11	13	15	V_{DC}
Gate-Emitter Leakage Current	I_{GES}	$V_{GE} = 10\text{ V}$	$T_J = -40^{\circ}C$ to $150^{\circ}C$	384	640	1000	μA_{DC}
Gate Resistor	R_G	-	$T_J = -40^{\circ}C$ to $150^{\circ}C$	-	70	-	Ω
Gate Emitter Resistor	R_{GE}	-	$T_J = -40^{\circ}C$ to $150^{\circ}C$	10	16	26	k Ω

ON CHARACTERISTICS (Note 2)

Gate Threshold Voltage	$V_{GE(th)}$	$I_C = 1.0\text{ mA}$, $V_{GE} = V_{CE}$	$T_J = 25^{\circ}C$	1.1	1.4	1.9	V_{DC}
			$T_J = 150^{\circ}C$	0.75	1.0	1.4	
			$T_J = -40^{\circ}C$	1.2	1.6	2.1*	
Threshold Temperature Coefficient (Negative)	-	-	-	-	3.4	-	mV/ $^{\circ}C$

1. When surface mounted to an FR4 board using the minimum recommended pad size.

2. Pulse Test: Pulse Width $\leq 300\ \mu s$, Duty Cycle $\leq 2\%$.

*Maximum Value of Characteristic across Temperature Range.

**NGD15N41CL, NGD15N41ACL, NGB15N41CL, NGB15N41ACL, NGP15N41CL,
NGP15N41ACL**

ELECTRICAL CHARACTERISTICS (continued)

Characteristic	Symbol	Test Conditions	Temperature	Min	Typ	Max	Unit
ON CHARACTERISTICS (continued) (Note 3)							
Collector-to-Emitter On-Voltage	$V_{CE(on)}$	$I_C = 6.0 \text{ A},$ $V_{GE} = 4.0 \text{ V}$	$T_J = 25^\circ\text{C}$	1.0	1.6	1.8	V_{DC}
			$T_J = 150^\circ\text{C}$	0.9	1.5	1.8	
			$T_J = -40^\circ\text{C}$	1.1	1.65	1.9*	
		$I_C = 8.0 \text{ A},$ $V_{GE} = 4.0 \text{ V}$	$T_J = 25^\circ\text{C}$	1.3	1.8	2.0*	
			$T_J = 150^\circ\text{C}$	1.2	1.7	1.9	
			$T_J = -40^\circ\text{C}$	1.4	1.8	2.0*	
		$I_C = 10 \text{ A},$ $V_{GE} = 4.0 \text{ V}$	$T_J = 25^\circ\text{C}$	1.4	2.0	2.2	
			$T_J = 150^\circ\text{C}$	1.5	2.0	2.3*	
			$T_J = -40^\circ\text{C}$	1.4	2.0	2.2	
		$I_C = 10 \text{ A},$ $V_{GE} = 4.5 \text{ V}$	$T_J = 25^\circ\text{C}$	1.3	1.9	2.1	
			$T_J = 150^\circ\text{C}$	1.3	1.9	2.1	
			$T_J = -40^\circ\text{C}$	1.4	1.95	2.1*	
Forward Transconductance	gfs	$V_{CE} = 5.0 \text{ V}, I_C = 6.0 \text{ A}$	$T_J = -40^\circ\text{C}$ to 150°C	8.0	15	25	Mhos

DYNAMIC CHARACTERISTICS

Input Capacitance	C_{ISS}	$V_{CC} = 25 \text{ V}, V_{GE} = 0 \text{ V}$ $f = 1.0 \text{ MHz}$	$T_J = -40^\circ\text{C}$ to 150°C	400	650	1000	pF
Output Capacitance	C_{OSS}			30	55	100	
Transfer Capacitance	C_{RSS}			3.0	4.5	8.0	

SWITCHING CHARACTERISTICS

Turn-Off Delay Time (Inductive)	$t_{d(off)}$	$V_{CC} = 300 \text{ V}, I_C = 6.5 \text{ A}$ $R_G = 1.0 \text{ k}\Omega, L = 300 \mu\text{H}$	$T_J = 25^\circ\text{C}$	-	4.0	10	μSec
			$T_J = 150^\circ\text{C}$	-	4.5	10	
Fall Time (Inductive)	t_f	$V_{CC} = 300 \text{ V}, I_C = 6.5 \text{ A}$ $R_G = 1.0 \text{ k}\Omega, L = 300 \mu\text{H}$	$T_J = 25^\circ\text{C}$	-	6.0	12	μSec
			$T_J = 150^\circ\text{C}$	-	10	12	
Turn-Off Delay Time (Resistive)	$t_{d(off)}$	$V_{CC} = 300 \text{ V}, I_C = 6.5 \text{ A}$ $R_G = 1.0 \text{ k}\Omega, R_L = 46 \Omega,$	$T_J = 25^\circ\text{C}$	-	3.0	10	μSec
			$T_J = 150^\circ\text{C}$	-	3.5	10	
Fall Time (Resistive)	t_f	$V_{CC} = 300 \text{ V}, I_C = 6.5 \text{ A}$ $R_G = 1.0 \text{ k}\Omega, R_L = 46 \Omega,$	$T_J = 25^\circ\text{C}$	-	8.0	15	μSec
			$T_J = 150^\circ\text{C}$	-	12	15	
Turn-On Delay Time	$t_{d(on)}$	$V_{CC} = 10 \text{ V}, I_C = 6.5 \text{ A}$ $R_G = 1.0 \text{ k}\Omega, R_L = 1.5 \Omega$	$T_J = 25^\circ\text{C}$	-	0.7	4.0	μSec
			$T_J = 150^\circ\text{C}$	-	0.7	4.0	
Rise Time	t_r	$V_{CC} = 10 \text{ V}, I_C = 6.5 \text{ A}$ $R_G = 1.0 \text{ k}\Omega, R_L = 1.5 \Omega$	$T_J = 25^\circ\text{C}$	-	4.0	7.0	μSec
			$T_J = 150^\circ\text{C}$	-	5.0	7.0	

3. Pulse Test: Pulse Width $\leq 300 \mu\text{s}$, Duty Cycle $\leq 2\%$.

*Maximum Value of Characteristic across Temperature Range.

NGD15N41CL, NGD15N41ACL, NGB15N41CL, NGB15N41ACL, NGP15N41CL, NGP15N41ACL

TYPICAL ELECTRICAL CHARACTERISTICS (unless otherwise noted)

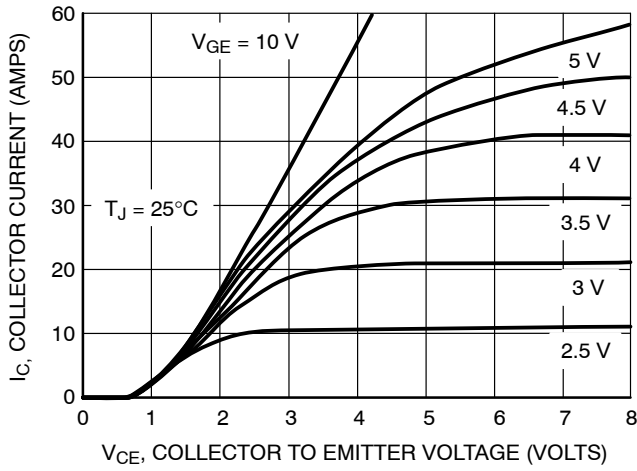

Figure 1. Output Characteristics

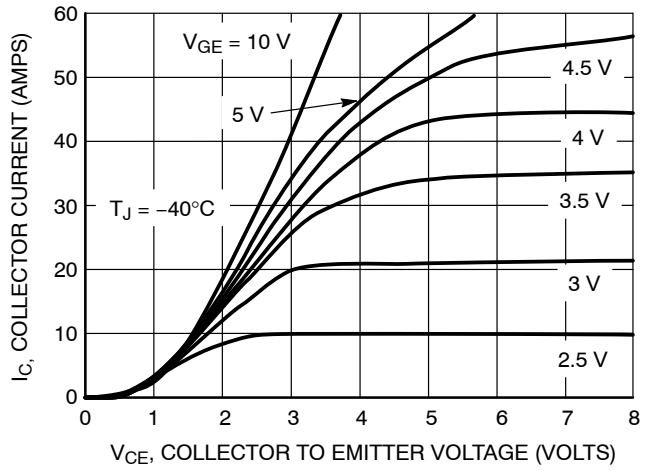

Figure 2. Output Characteristics

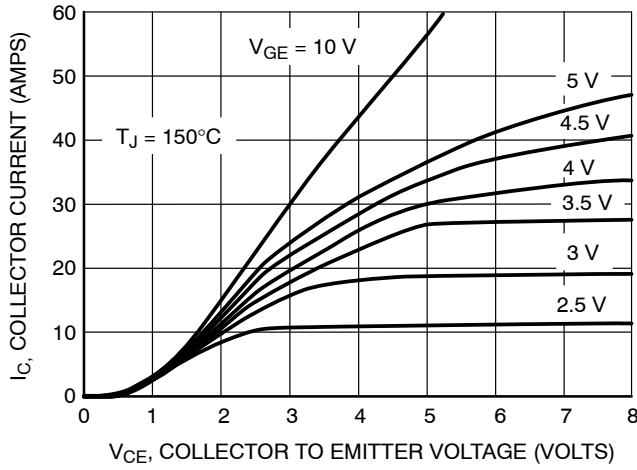

Figure 3. Output Characteristics

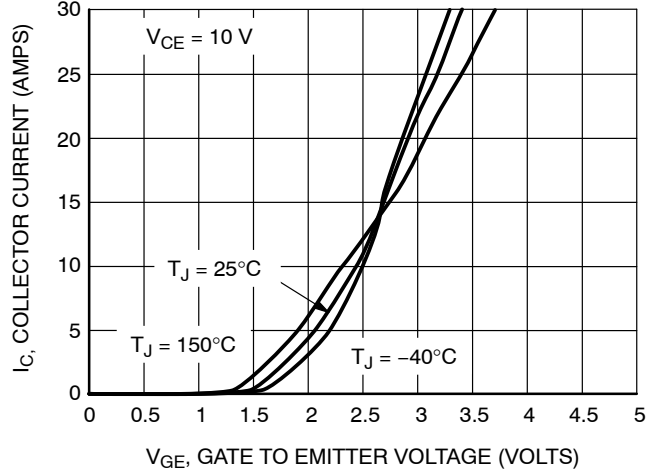

Figure 4. Transfer Characteristics

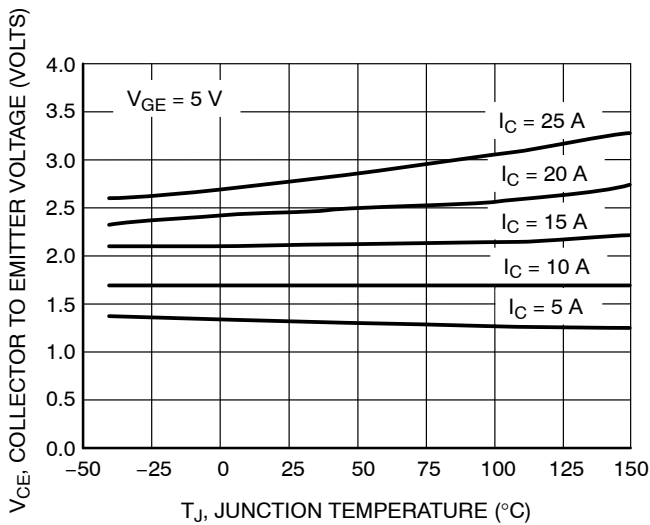

Figure 5. Collector-to-Emitter Saturation Voltage versus Junction Temperature

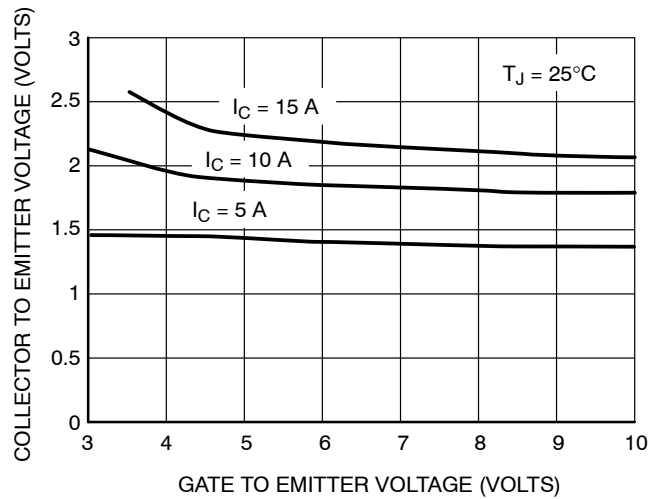

Figure 6. Collector-to-Emitter Voltage versus Gate-to-Emitter Voltage

NGD15N41CL, NGD15N41ACL, NGB15N41CL, NGB15N41ACL, NGP15N41CL, NGP15N41ACL

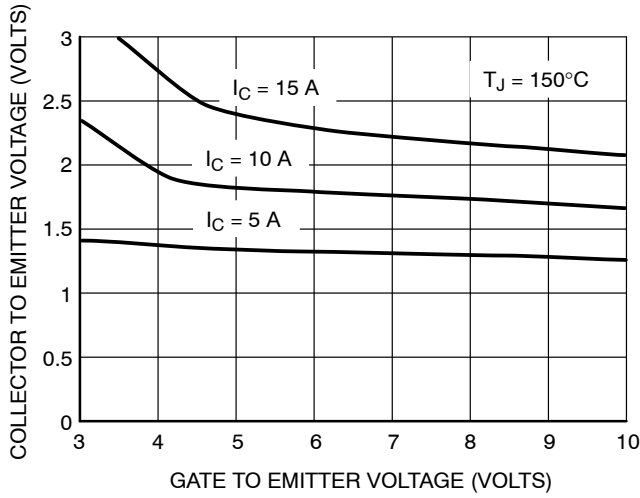

Figure 7. Collector-to-Emitter Voltage versus Gate-to-Emitter Voltage

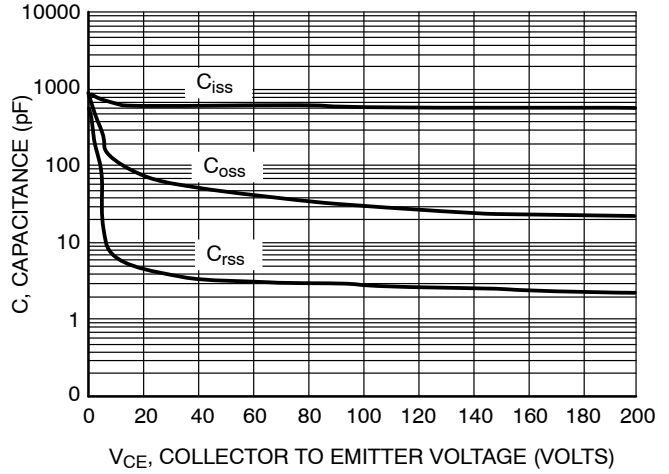

Figure 8. Capacitance Variation

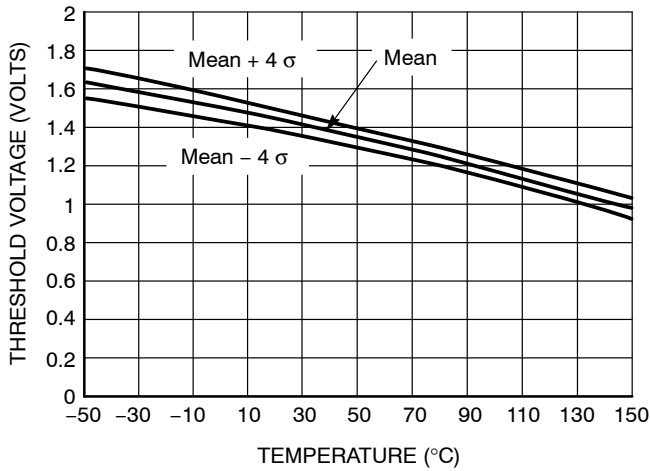

Figure 9. Gate Threshold Voltage versus Temperature

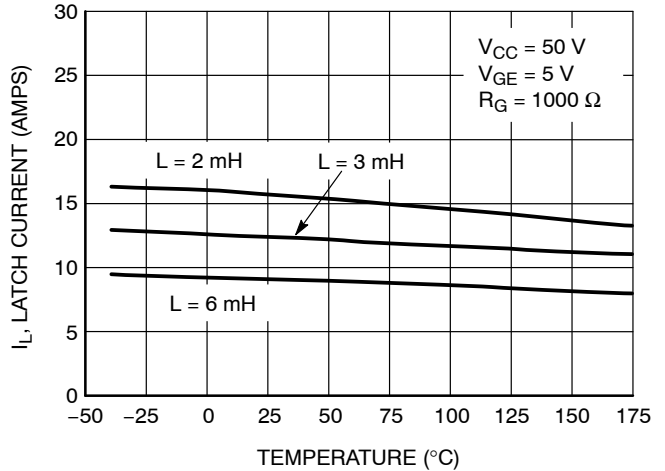

Figure 10. Minimum Open Secondary Latch Current versus Temperature

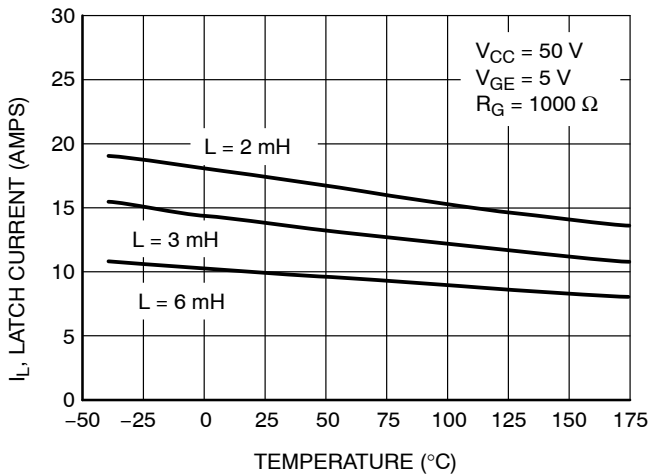

Figure 11. Typical Open Secondary Latch Current versus Temperature

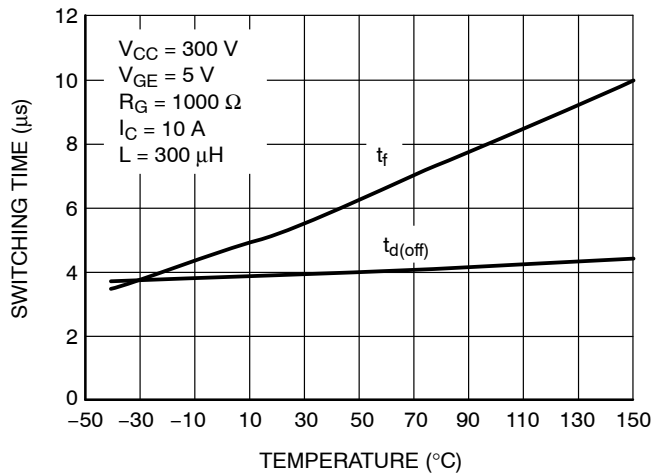
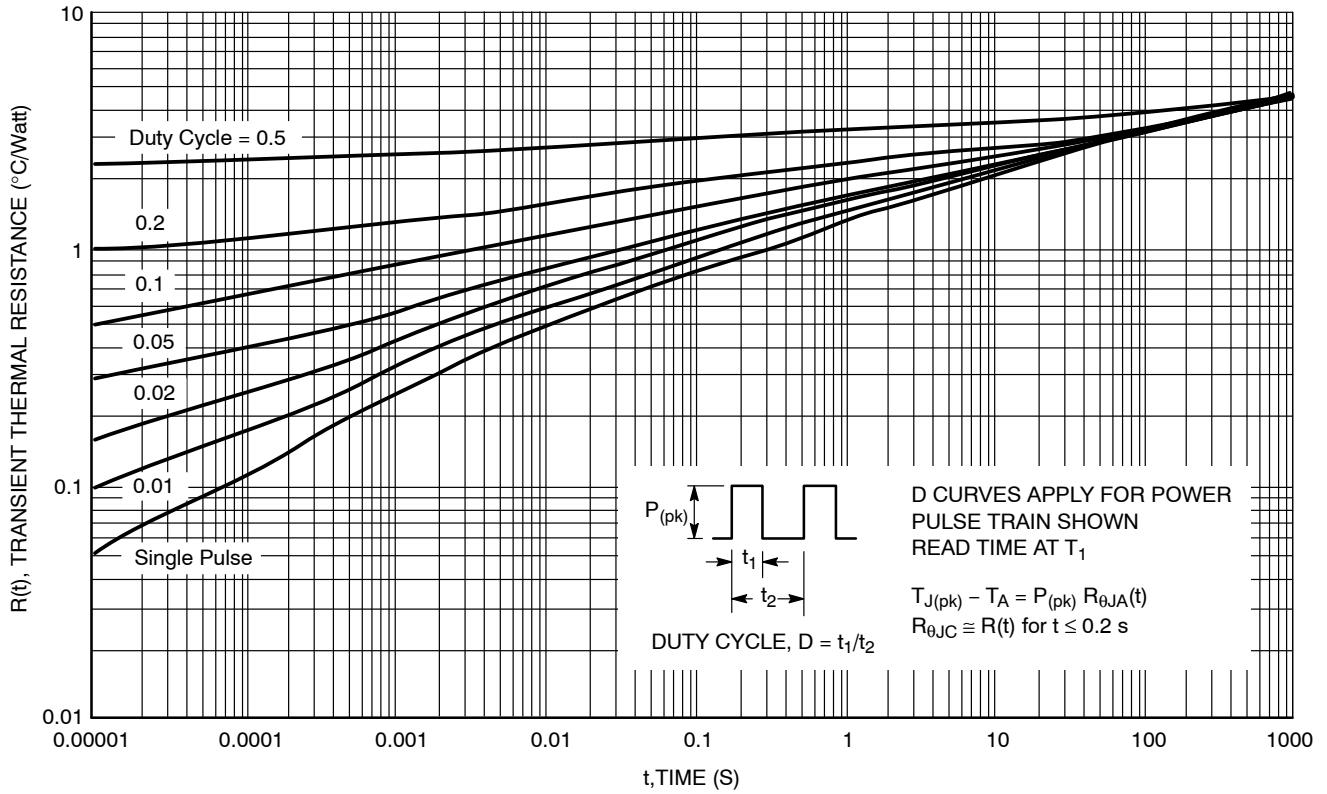
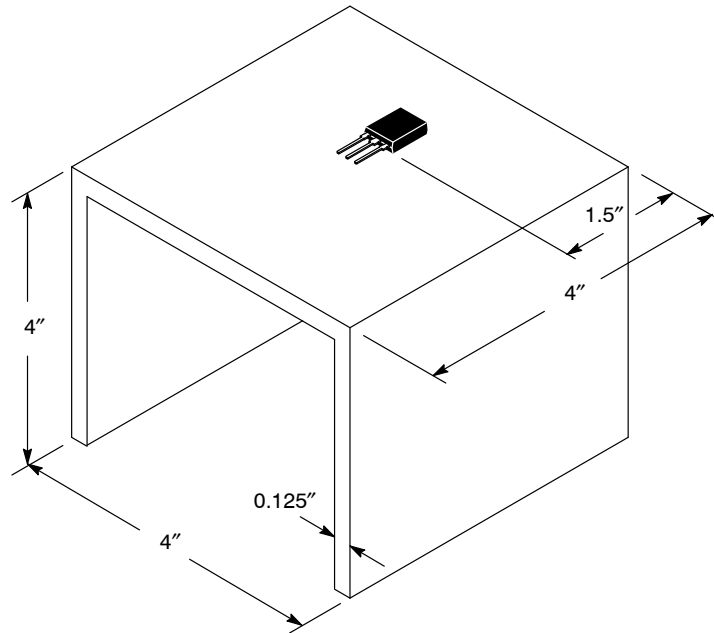

Figure 12. Inductive Switching Fall Time versus Temperature

NGD15N41CL, NGD15N41ACL, NGB15N41CL, NGB15N41ACL, NGP15N41CL,
NGP15N41ACL



**Figure 13. Transient Thermal Resistance
(Non-normalized Junction-to-Ambient mounted on
fixture in Figure 14)**



**Figure 14. Test Fixture for Transient Thermal Curve
(48 square inches of 1/8" thick aluminum)**

NGD15N41CL, NGD15N41ACL, NGB15N41CL, NGB15N41ACL, NGP15N41CL, NGP15N41ACL

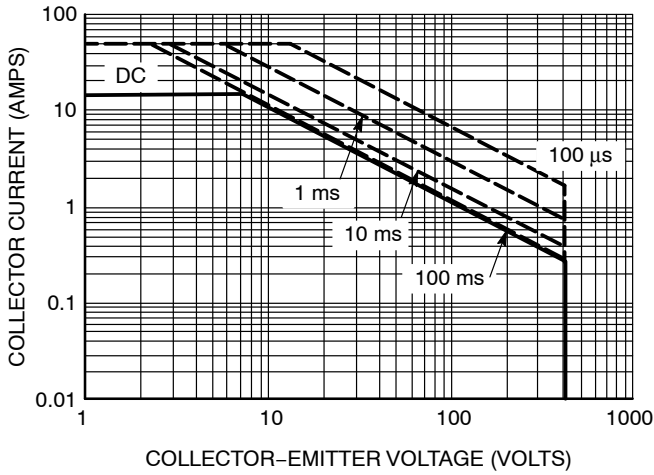

Figure 15. Single Pulse Safe Operating Area (Mounted on an Infinite Heatsink at $T_A = 25^\circ\text{C}$)

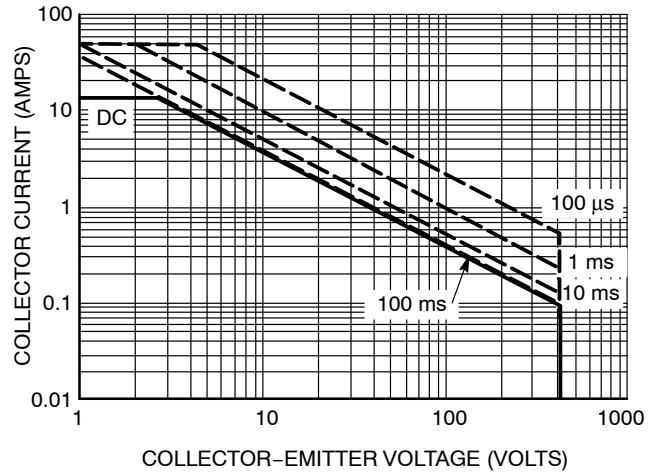

Figure 16. Single Pulse Safe Operating Area (Mounted on an Infinite Heatsink at $T_A = 125^\circ\text{C}$)

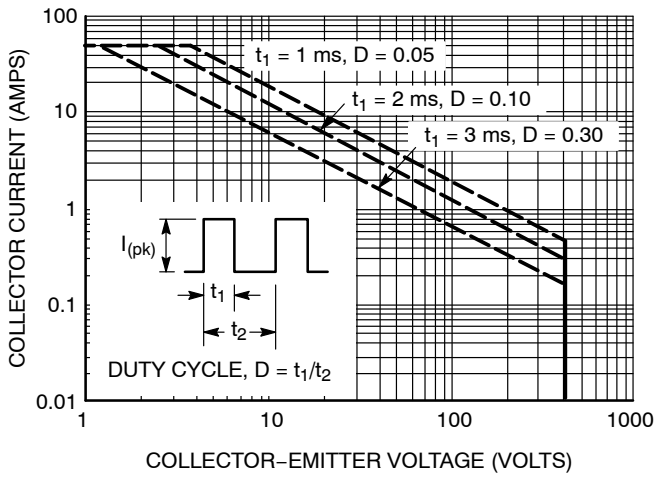

Figure 17. Pulse Train Safe Operating Area (Mounted on an Infinite Heatsink at $T_C = 25^\circ\text{C}$)

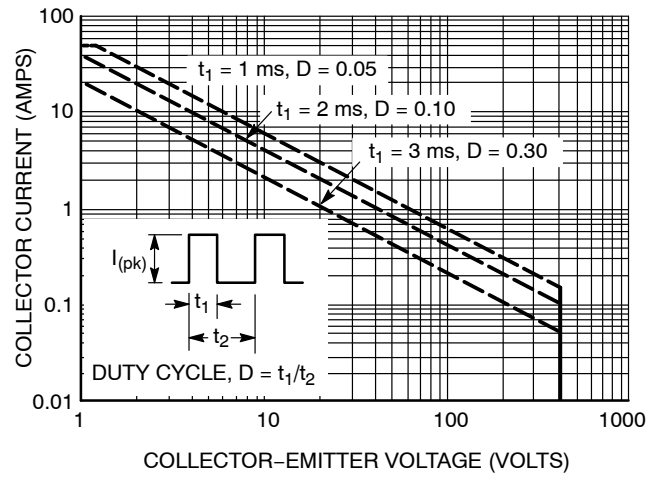

Figure 18. Pulse Train Safe Operating Area (Mounted on an Infinite Heatsink at $T_C = 125^\circ\text{C}$)

NGD15N41CL, NGD15N41ACL, NGB15N41CL, NGB15N41ACL, NGP15N41CL, NGP15N41ACL

ORDERING INFORMATION

Device	Package Type	Shipping [†]
NGD15N41CLT4G	DPAK (Pb-Free)	2500/Tape & Reel
NGD15N41ACL4G		
NGB15N41CLT4G	D ² PAK (Pb-Free)	800/Tape & Reel
NGB15N41ACL4G		
NGP15N41CLG	TO-220 (Pb-Free)	50 Units/Rail
NGP15N41ACLG		

[†]For information on tape and reel specifications, including part orientation and tape sizes, please refer to our Tape and Reel Packaging Specification Brochure, BRD8011/D.

MARKING DIAGRAMS

**DPAK
CASE 369C
STYLE 7**

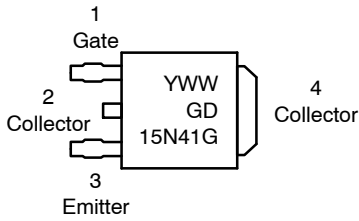

**D²PAK
CASE 418B
STYLE 4**

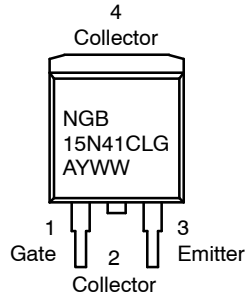

**TO-220AB
CASE 221A
STYLE 9**

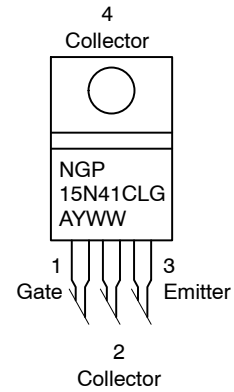

A = Assembly Location
 Y = Year
 WW = Work Week
 G = Pb-Free Device

NGD15N41CL, NGD15N41ACL, NGB15N41CL, NGB15N41ACL, NGP15N41CL,
NGP15N41ACL

PACKAGE DIMENSIONS

DPAK (SINGLE GAUGE)

CASE 369C-01

ISSUE D

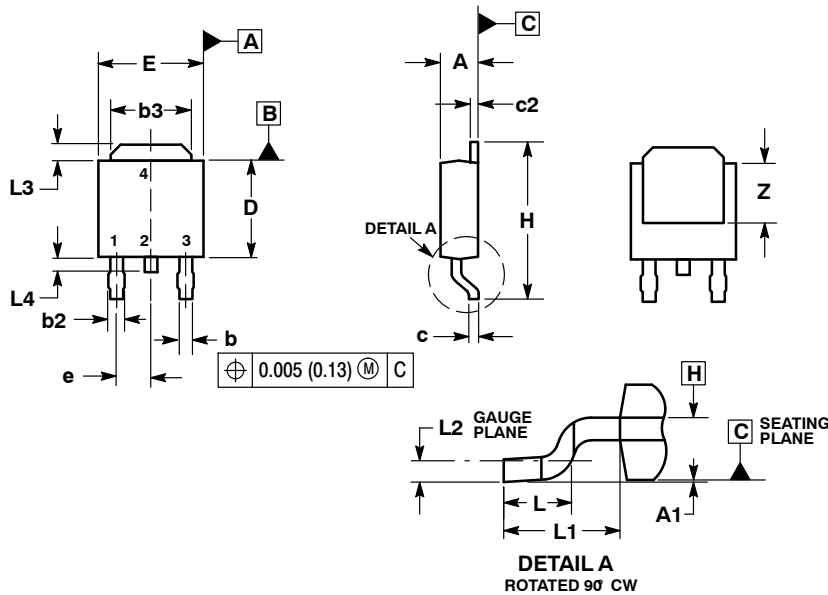

NOTES:

1. DIMENSIONING AND TOLERANCING PER ASME Y14.5M, 1994.
2. CONTROLLING DIMENSION: INCHES.
3. THERMAL PAD CONTOUR OPTIONAL WITHIN DIMENSIONS b3, L3 and Z.
4. DIMENSIONS D AND E DO NOT INCLUDE MOLD FLASH, PROTRUSIONS, OR BURRS. MOLD FLASH, PROTRUSIONS, OR GATE BURRS SHALL NOT EXCEED 0.006 INCHES PER SIDE.
5. DIMENSIONS D AND E ARE DETERMINED AT THE OUTERMOST EXTREMES OF THE PLASTIC BODY.
6. DATUMS A AND B ARE DETERMINED AT DATUM PLANE H.

DIM	INCHES		MILLIMETERS	
	MIN	MAX	MIN	MAX
A	0.086	0.094	2.18	2.38
A1	0.000	0.005	0.00	0.13
b	0.025	0.035	0.63	0.89
b2	0.030	0.045	0.76	1.14
b3	0.180	0.215	4.57	5.46
c	0.018	0.024	0.46	0.61
c2	0.018	0.024	0.46	0.61
D	0.235	0.245	5.97	6.22
E	0.250	0.265	6.35	6.73
e	0.090 BSC		2.29 BSC	
H	0.370	0.410	9.40	10.41
L	0.055	0.070	1.40	1.78
L1	0.108 REF		2.74 REF	
L2	0.020 BSC		0.51 BSC	
L3	0.035	0.050	0.89	1.27
L4	---	0.040	---	1.01
Z	0.155	---	3.93	---

SOLDERING FOOTPRINT*

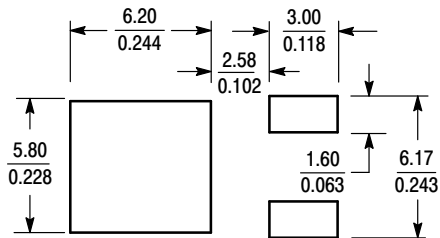

SCALE 3:1 (mm/inches)

STYLE 2:

- PIN 1. GATE
2. DRAIN
3. SOURCE
4. DRAIN

*For additional information on our Pb-Free strategy and soldering details, please download the ON Semiconductor Soldering and Mounting Techniques Reference Manual, SOLDERRM/D.

NGD15N41CL, NGD15N41ACL, NGB15N41CL, NGB15N41ACL, NGP15N41CL,
NGP15N41ACL

PACKAGE DIMENSIONS

D²PAK
CASE 418B-04
ISSUE K

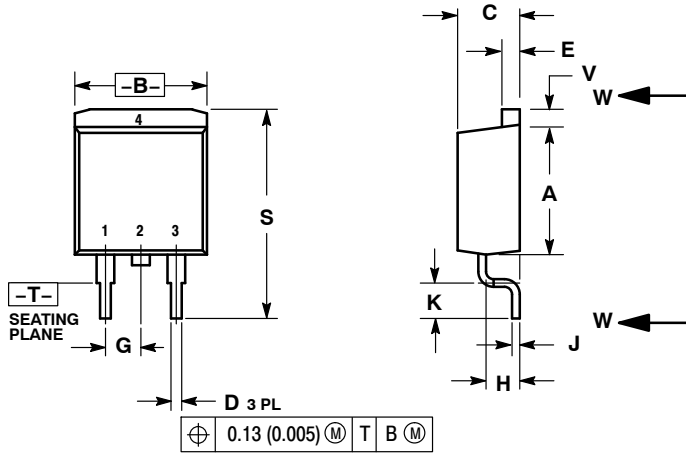

NOTES:

1. DIMENSIONING AND TOLERANCING PER ANSI Y14.5M, 1982.
2. CONTROLLING DIMENSION: INCH.
3. 418B-01 THRU 418B-03 OBSOLETE, NEW STANDARD 418B-04.

DIM	INCHES		MILLIMETERS	
	MIN	MAX	MIN	MAX
A	0.340	0.380	8.64	9.65
B	0.380	0.405	9.65	10.29
C	0.160	0.190	4.06	4.83
D	0.020	0.035	0.51	0.89
E	0.045	0.055	1.14	1.40
F	0.310	0.350	7.87	8.89
G	0.100 BSC		2.54 BSC	
H	0.080	0.110	2.03	2.79
J	0.018	0.025	0.46	0.64
K	0.090	0.110	2.29	2.79
L	0.052	0.072	1.32	1.83
M	0.280	0.320	7.11	8.13
N	0.197 REF		5.00 REF	
P	0.079 REF		2.00 REF	
R	0.039 REF		0.99 REF	
S	0.575	0.625	14.60	15.88
V	0.045	0.055	1.14	1.40

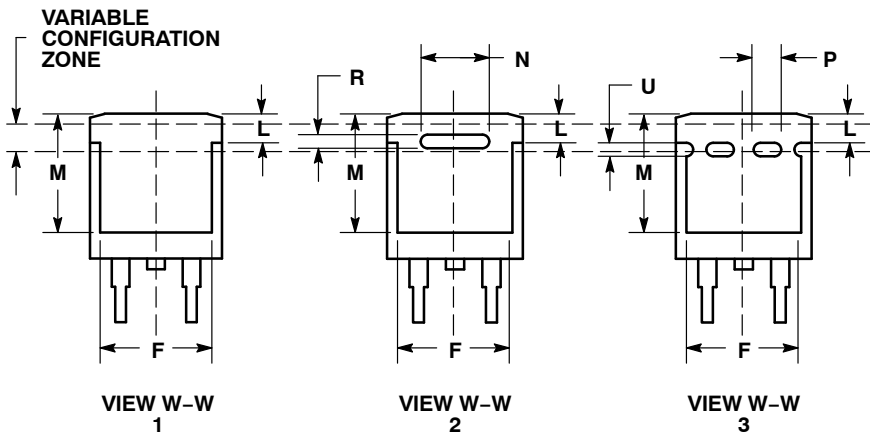

STYLE 4:

- PIN 1. GATE
2. COLLECTOR
3. EMITTER
4. COLLECTOR

SOLDERING FOOTPRINT*

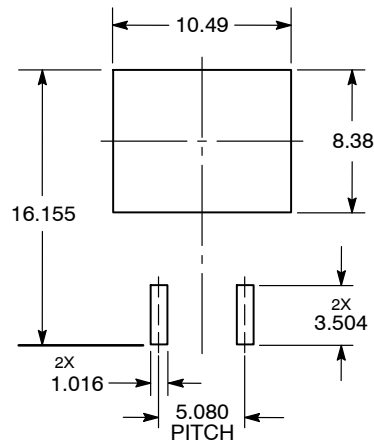

DIMENSIONS: MILLIMETERS

*For additional information on our Pb-Free strategy and soldering details, please download the ON Semiconductor Soldering and Mounting Techniques Reference Manual, SOLDERRM/D.

NGD15N41CL, NGD15N41ACL, NGB15N41CL, NGB15N41ACL, NGP15N41CL, NGP15N41ACL

PACKAGE DIMENSIONS

TO-220
CASE 221A-09
ISSUE AF

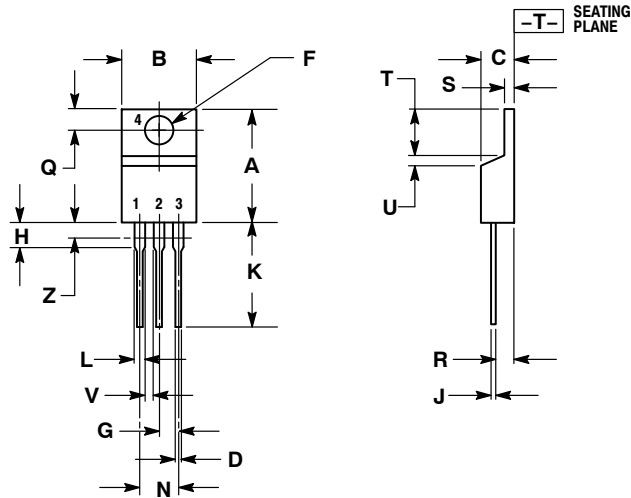

NOTES:

1. DIMENSIONING AND TOLERANCING PER ANSI Y14.5M, 1982.
2. CONTROLLING DIMENSION: INCH.
3. DIMENSION Z DEFINES A ZONE WHERE ALL BODY AND LEAD IRREGULARITIES ARE ALLOWED.

DIM	INCHES		MILLIMETERS	
	MIN	MAX	MIN	MAX
A	0.570	0.620	14.48	15.75
B	0.380	0.405	9.66	10.28
C	0.160	0.190	4.07	4.82
D	0.025	0.035	0.64	0.88
F	0.142	0.161	3.61	4.09
G	0.095	0.105	2.42	2.66
H	0.110	0.155	2.80	3.93
J	0.014	0.025	0.36	0.64
K	0.500	0.562	12.70	14.27
L	0.045	0.060	1.15	1.52
N	0.190	0.210	4.83	5.33
Q	0.100	0.120	2.54	3.04
R	0.080	0.110	2.04	2.79
S	0.045	0.055	1.15	1.39
T	0.235	0.255	5.97	6.47
U	0.000	0.050	0.00	1.27
V	0.045	---	1.15	---
Z	---	0.080	---	2.04

STYLE 9:

- PIN 1. GATE
2. COLLECTOR
3. EMITTER
4. COLLECTOR

ON Semiconductor and are registered trademarks of Semiconductor Components Industries, LLC (SCILLC). SCILLC reserves the right to make changes without further notice to any products herein. SCILLC makes no warranty, representation or guarantee regarding the suitability of its products for any particular purpose, nor does SCILLC assume any liability arising out of the application or use of any product or circuit, and specifically disclaims any and all liability, including without limitation special, consequential or incidental damages. "Typical" parameters which may be provided in SCILLC data sheets and/or specifications can and do vary in different applications and actual performance may vary over time. All operating parameters, including "Typicals" must be validated for each customer application by customer's technical experts. SCILLC does not convey any license under its patent rights nor the rights of others. SCILLC products are not designed, intended, or authorized for use as components in systems intended for surgical implant into the body, or other applications intended to support or sustain life, or for any other application in which the failure of the SCILLC product could create a situation where personal injury or death may occur. Should Buyer purchase or use SCILLC products for any such unintended or unauthorized application, Buyer shall indemnify and hold SCILLC and its officers, employees, subsidiaries, affiliates, and distributors harmless against all claims, costs, damages, and expenses, and reasonable attorney fees arising out of, directly or indirectly, any claim of personal injury or death associated with such unintended or unauthorized use, even if such claim alleges that SCILLC was negligent regarding the design or manufacture of the part. SCILLC is an Equal Opportunity/Affirmative Action Employer. This literature is subject to all applicable copyright laws and is not for resale in any manner.

PUBLICATION ORDERING INFORMATION

LITERATURE FULFILLMENT:

Literature Distribution Center for ON Semiconductor
P.O. Box 5163, Denver, Colorado 80217 USA
Phone: 303-675-2175 or 800-344-3860 Toll Free USA/Canada
Fax: 303-675-2176 or 800-344-3867 Toll Free USA/Canada
Email: orderlit@onsemi.com

N. American Technical Support: 800-282-9855 Toll Free
USA/Canada
Europe, Middle East and Africa Technical Support:
Phone: 421 33 790 2910
Japan Customer Focus Center
Phone: 81-3-5817-1050

ON Semiconductor Website: www.onsemi.com

Order Literature: <http://www.onsemi.com/orderlit>

For additional information, please contact your local Sales Representative



**Стандарт
Электрон
Связь**

Мы молодая и активно развивающаяся компания в области поставок электронных компонентов. Мы поставляем электронные компоненты отечественного и импортного производства напрямую от производителей и с крупнейших складов мира.

Благодаря сотрудничеству с мировыми поставщиками мы осуществляем комплексные и плановые поставки широчайшего спектра электронных компонентов.

Собственная эффективная логистика и склад в обеспечивает надежную поставку продукции в точно указанные сроки по всей России.

Мы осуществляем техническую поддержку нашим клиентам и предпродажную проверку качества продукции. На все поставляемые продукты мы предоставляем гарантию .

Осуществляем поставки продукции под контролем ВП МО РФ на предприятия военно-промышленного комплекса России , а также работаем в рамках 275 ФЗ с открытием отдельных счетов в уполномоченном банке. Система менеджмента качества компании соответствует требованиям ГОСТ ISO 9001.

Минимальные сроки поставки, гибкие цены, неограниченный ассортимент и индивидуальный подход к клиентам являются основой для выстраивания долгосрочного и эффективного сотрудничества с предприятиями радиоэлектронной промышленности, предприятиями ВПК и научно-исследовательскими институтами России.

С нами вы становитесь еще успешнее!

Наши контакты:

Телефон: +7 812 627 14 35

Электронная почта: sales@st-electron.ru

Адрес: 198099, Санкт-Петербург,
Промышленная ул, дом № 19, литера Н,
помещение 100-Н Офис 331