

RoHS

## Lxx08xx & Qxx08xx & Qxx08xHx Series



### Description

8 Amp bi-directional solid state switch series is designed for AC switching and phase control applications such as motor speed and temperature modulation controls, lighting controls, and static switching relays.

**Sensitive** type devices guarantee gate control in Quadrants I & IV needed for digital control circuitry.

**Standard** type devices normally operate in Quadrants I & III triggered from AC line.

**Alternistor** type devices only operate in quadrants I, II, & III and are used in circuits requiring high dv/dt capability.

### Agency Approval

Agency	Agency File Number
	L Package: E71639

### Main Features

Symbol	Value	Unit
$I_{T(RMS)}$	8	A
$V_{DRM}/V_{RRM}$	400 to 1000	V
$I_{GT(Q1)}$	5 to 50	mA

### Schematic Symbol

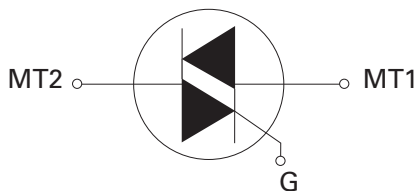

### Features & Benefits

- RoHS compliant
- Glass – passivated junctions
- Voltage capability up to 1000 V
- Surge capability up to 100 A
- Electrically isolated “L-Package” is UL recognized for 2500Vrms
- Solid-state switching eliminates arcing or contact bounce that create voltage transients
- No contacts to wear out from reaction of switching events
- Restricted (or limited) RFI generation, depending on activation point of sine wave
- Requires only a small gate activation pulse in each half-cycle

### Applications

Excellent for AC switching and phase control applications such as heating, lighting, and motor speed controls.

Typical applications are AC solid-state switches, light dimmers, power tools, home/brown goods and white goods appliances.

Alternistor Triacs (no snubber required) are used in applications with extremely inductive loads requiring highest commutation performance.

Internally constructed isolated packages are offered for ease of heat sinking with highest isolation voltage.

**Absolute Maximum Ratings — Sensitive Triac (4 Quadrants)**

Symbol	Parameter		Value	Unit	
$I_{T(RMS)}$	RMS on-state current (full sine wave)	Lxx08Ly	$T_C = 80^\circ\text{C}$	8	A
		Lxx08Ry / Lxx08Vy / Lxx08Dy	$T_C = 85^\circ\text{C}$		
$I_{TSM}$	Non repetitive surge peak on-state current (full cycle, $T_J$ initial = $25^\circ\text{C}$ )	f = 50 Hz	t = 20 ms	65	A
		f = 60 Hz	t = 16.7 ms	85	
$I^2t$	$I^2t$ Value for fusing	$t_p = 8.3$ ms		26.5	$\text{A}^2\text{s}$
di/dt	Critical rate of rise of on-state current $I_G = 50\text{mA}$ with $0.1\mu\text{s}$ rise time	f = 120 Hz	$T_J = 110^\circ\text{C}$	70	$\text{A}/\mu\text{s}$
$I_{GTM}$	Peak gate trigger current	$t_p \leq 10 \mu\text{s}$	$T_J = 110^\circ\text{C}$	1.6	A
$P_{G(AV)}$	Average gate power dissipation	$T_J = 110^\circ\text{C}$		0.4	W
$T_{stg}$	Storage temperature range			-40 to 150	$^\circ\text{C}$
$T_J$	Operating junction temperature range			-40 to 110	$^\circ\text{C}$

Note: xx = voltage, y = sensitivity

**Absolute Maximum Ratings — Standard Triac**

Symbol	Parameter		Value	Unit	
$I_{T(RMS)}$	RMS on-state current (full sine wave)	Qxx08Ry / Qxx08Ny	$T_C = 95^\circ\text{C}$	8	A
		Qxx08Ly	$T_C = 90^\circ\text{C}$		
$I_{TSM}$	Non repetitive surge peak on-state current (full cycle, $T_J$ initial = $25^\circ\text{C}$ )	f = 50 Hz	t = 20 ms	83	A
		f = 60 Hz	t = 16.7 ms	100	
$I^2t$	$I^2t$ Value for fusing	$t_p = 8.3$ ms		41	$\text{A}^2\text{s}$
di/dt	Critical rate of rise of on-state current $I_G = 200\text{mA}$ with $\leq 0.1\mu\text{s}$ rise time	f = 120 Hz	$T_J = 125^\circ\text{C}$	70	$\text{A}/\mu\text{s}$
$I_{GTM}$	Peak gate trigger current	$t_p \leq 10 \mu\text{s};$ $I_{GT} \leq I_{GTM}$	$T_J = 125^\circ\text{C}$	1.8	A
$P_{G(AV)}$	Average gate power dissipation	$T_J = 125^\circ\text{C}$		0.5	W
$T_{stg}$	Storage temperature range			-40 to 150	$^\circ\text{C}$
$T_J$	Operating junction temperature range			-40 to 125	$^\circ\text{C}$

Note: xx = voltage, y = sensitivity

**Absolute Maximum Ratings — Alternistor (3 Quadrants)**

Symbol	Parameter		Value	Unit		
$I_{T(RMS)}$	RMS on-state current (full sine wave)	Qxx08LHy	$T_C = 90^\circ\text{C}$	8	A	
		Qxx08RHy / Qxx08NHy Qxx08VHy / Qxx08DHy	$T_C = 95^\circ\text{C}$			
$I_{TSM}$	Non repetitive surge peak on-state current (full cycle, $T_J$ initial = $25^\circ\text{C}$ )	f = 50 Hz	t = 20 ms	Qxx08VHy / Qxx08DHy	80	A
				Qxx08LHy / Qxx08RHy / Qxx08NHy	83	
		f = 60 Hz	t = 16.7 ms	Qxx08VHy / Qxx08DHy	85	
				Qxx08LHy / Qxx08RHy / Qxx08NHy	100	
$I^2t$	$I^2t$ Value for fusing	$t_p = 8.3$ ms	Qxx08VHy / Qxx08DHy	30	$\text{A}^2\text{s}$	
			Qxx08LHy / Qxx08RHy / Qxx08NHy	41		
di/dt	Critical rate of rise of on-state current	f = 120 Hz	$T_J = 125^\circ\text{C}$	70	A/ $\mu\text{s}$	
$I_{GTM}$	Peak gate trigger current	$t_p \leq 10 \mu\text{s};$ $I_{GT} \leq I_{GTM}$	$T_J = 125^\circ\text{C}$	Qxx08VHy / Qxx08DHy	1.6	A
				Qxx08LHy / Qxx08RHy / Qxx08NHy	2.0	
$P_{G(AV)}$	Average gate power dissipation	$T_J = 125^\circ\text{C}$	$I_{GT} = 10\text{mA}$	Qxx08VHy / Qxx08DHy	0.4	W
			$I_{GT} = 35\text{mA}$	Qxx08LHy / Qxx08RHy / Qxx08NHy	0.5	
$T_{stg}$	Storage temperature range			-40 to 150	$^\circ\text{C}$	
$T_J$	Operating junction temperature range			-40 to 125	$^\circ\text{C}$	

Note: xx = voltage, y = sensitivity

**Electrical Characteristics ( $T_J = 25^\circ\text{C}$ , unless otherwise specified) — Sensitive Triac (4 Quadrants)**

Symbol	Test Conditions	Quadrant		Lxx08x6	Lxx08x8	Unit
$I_{GT}$	$V_D = 12\text{V}$ $R_L = 60 \Omega$	I – II – III IV	MAX.	5 10	10 20	mA
$V_{GT}$		ALL	MAX.	1.3		
$V_{GD}$	$V_D = V_{DRM}$ $R_L = 3.3 \text{ k}\Omega$ $T_J = 110^\circ\text{C}$	ALL	MIN.	0.2		V
$I_H$	$I_T = 100\text{mA}$		MAX.	10	20	mA
dv/dt	$V_D = V_{DRM}$ Gate Open $T_J = 100^\circ\text{C}$	400V	TYP.	30	40	
		600V		20	30	
(dv/dt)c	(di/dt)c = 4.3 A/ms $T_J = 110^\circ\text{C}$		TYP.	2	2	V/ $\mu\text{s}$
$t_{gt}$	$I_G = 100\text{mA}$ $PW = 15\mu\text{s}$ $I_T = 11.3 \text{ A(pk)}$		TYP.	3.0	3.2	$\mu\text{s}$

Note: xx = voltage, x = package, y = sensitivity

**Electrical Characteristics (T<sub>J</sub> = 25°C, unless otherwise specified) — Standard Triac**

Symbol	Test Conditions	Quadrant		Qxx08x4	Qxx08x5	Unit
I <sub>GT</sub>	V <sub>D</sub> = 12V R <sub>L</sub> = 60 Ω	I – II – III IV	MAX. TYP.	25 50	50 75	mA
V <sub>GT</sub>		I – II – III	MAX.	1.3		V
V <sub>GD</sub>	V <sub>D</sub> = V <sub>DRM</sub> R <sub>L</sub> = 3.3 kΩ T <sub>J</sub> = 125°C	ALL	MIN.	0.2		V
I <sub>H</sub>	I <sub>T</sub> = 200mA		MAX.	50	50	mA
dv/dt	V <sub>D</sub> = V <sub>DRM</sub> Gate Open T <sub>J</sub> = 125°C	400V	MIN.	150		V/μs
		600V			125	
		800V			100	
		1000V			80	
(dv/dt)c	(di/dt)c = 4.3 A/ms T <sub>J</sub> = 125°C		TYP.	4	4	V/μs
t <sub>gt</sub>	I <sub>G</sub> = 100mA PW = 15μs I <sub>T</sub> = 11.3 A(pk)		TYP.	3.0	3.0	μs

**Electrical Characteristics (T<sub>J</sub> = 25°C, unless otherwise specified) — Alternistor Triac (3 Quadrants)**

Symbol	Test Conditions	Quadrant			Qxx08xH3	Qxx08xH4	Unit
I <sub>GT</sub>	V <sub>D</sub> = 12V R <sub>L</sub> = 60 Ω	I – II – III	MAX.		10	35	mA
V <sub>GT</sub>		I – II – III	MAX.		1.3		V
V <sub>GD</sub>	V <sub>D</sub> = V <sub>DRM</sub> R <sub>L</sub> = 3.3 kΩ T <sub>J</sub> = 125°C	I – II – III	MIN.		0.2		V
I <sub>H</sub>	I <sub>T</sub> = 100mA		MAX.		15	35	mA
dv/dt	V <sub>D</sub> = V <sub>DRM</sub> Gate Open T <sub>J</sub> = 125°C	Qxx08LHy / Qxx08RH <sub>y</sub> / Qxx08NH <sub>y</sub>	MIN.	400V	75	400	V/μs
				600V	50	300	
				800V		200	
				1000V		100	
		Qxx08VHy / Qxx08DH <sub>y</sub>		400V	75	450	
				600V	50	350	
				800V		250	
				1000V		150	
(dv/dt)c	(di/dt)c = 4.3 A/ms T <sub>J</sub> = 125°C		MIN.		20	25	V/μs
t <sub>gt</sub>	I <sub>G</sub> = 100mA PW = 15μs I <sub>T</sub> = 11.3 A(pk)		TYP.		4.0	4.0	μs

Note : xx = voltage, x = package, y = sensitivity

### Static Characteristics

Symbol	Test Conditions			Value	Unit	
$V_{TM}$	$I_{TM} = 11.3A$ $t_p = 380 \mu s$			MAX.	1.60 V	
$I_{DRM}$ $I_{RRM}$	$V_{DRM} = V_{RRM}$	Lxx08xy	$T_J = 25^\circ C$	400 - 600V	MAX.	20 $\mu A$
			$T_J = 110^\circ C$	400 - 600V		0.5 mA
		Qxx08xy	$T_J = 25^\circ C$	400 - 1000V		50 $\mu A$
			$T_J = 125^\circ C$	400 - 800V		2 mA
			$T_J = 100^\circ C$	1000V		3 mA
		Qxx08xHy	$T_J = 25^\circ C$	400 - 800V		10 $\mu A$
				1000V		20 $\mu A$
			$T_J = 125^\circ C$	400 - 800V		2 mA
			$T_J = 100^\circ C$	1000V		3 mA

### Thermal Resistances

Symbol	Parameter	Value	Unit
$R_{\theta(J-C)}$	Junction to case (AC)	L/Qxx08Ryy / L/Qxx08Nyy	1.5
		L/Qxx08Lyy	2.8
		L/Qxx08Vyy	2.1
$R_{\theta(J-A)}$	Junction to ambient	L/Qxx08Ryy	45
		L/Qxx08Lyy	50
		L/Qxx08Vyy	64

Note: xx = voltage, x = package, y = sensitivity, yy = type & sensitivity

#### Figure 1: Definition of Quadrants



#### Figure 2: Normalized DC Gate Trigger Current for All Quadrants vs. Junction Temperature

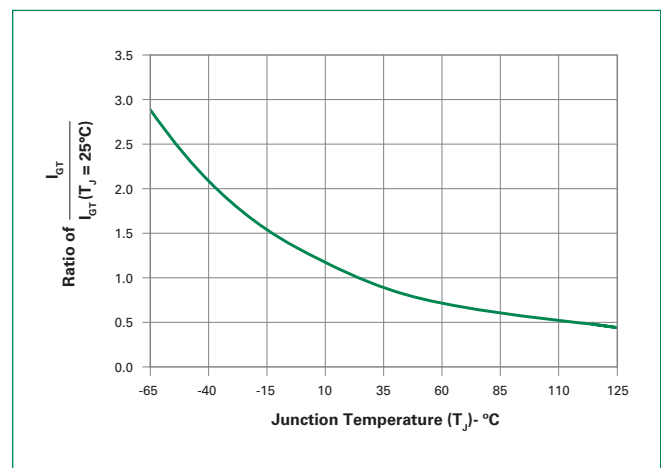

**Figure 3: Normalized DC Holding Current vs. Junction Temperature**



**Figure 4: Normalized DC Gate Trigger Voltage for All Quadrants vs. Junction Temperature**

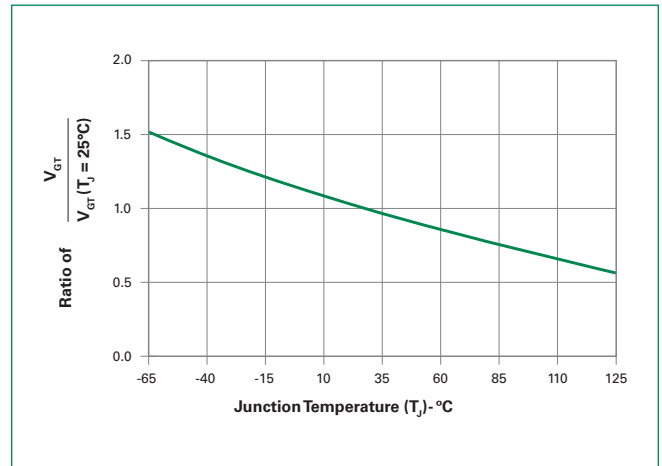

**Figure 5: Power Dissipation (Typical) vs. RMS On-State Current**



**Figure 6: Maximum Allowable Case Temperature vs. On-State Current (Sensitive Triac)**



**Figure 7: Maximum Allowable Case Temperature vs. On-State Current (Standard / Alternistor Triac)**



**Figure 8: On-State Current vs. On-State Voltage (Typical)**



Note: xx = voltage, x = package, y = sensitivity, yy = type & sensitivity

Figure 9: Maximum Allowable Ambient Temperature vs. On-State Current



Figure 10: Surge Peak On-State Current vs. Number of Cycles



SUPPLY FREQUENCY: 60 Hz Sinusoidal  
LOAD: Resistive  
RMS On-State Current:  $I_{T(RMS)}$ : Maximum Rated Value at Specified Case Temperature

Notes:  
1. Gate control may be lost during and immediately following surge current interval.  
2. Overload may not be repeated until junction temperature has returned to steady-state rated value.

Note: xx = voltage, x = package, y = sensitivity, yy = type & sensitivity

**Soldering Parameters**

Reflow Condition		Pb – Free assembly
Pre Heat	- Temperature Min ( $T_{s(min)}$ )	150°C
	- Temperature Max ( $T_{s(max)}$ )	200°C
	- Time (min to max) ( $t_s$ )	60 – 180 secs
Average ramp up rate (Liquidus Temp ( $T_L$ ) to peak)		5°C/second max
$T_{s(max)}$ to $T_L$ - Ramp-up Rate		5°C/second max
Reflow	- Temperature ( $T_L$ ) (Liquidus)	217°C
	- Temperature ( $t_L$ )	60 – 150 seconds
Peak Temperature ( $T_p$ )		260 <sup>+0/-5</sup> °C
Time within 5°C of actual peak Temperature ( $t_p$ )		20 – 40 seconds
Ramp-down Rate		5°C/second max
Time 25°C to peak Temperature ( $T_p$ )		8 minutes Max.
Do not exceed		280°C



**Physical Specifications**

<b>Terminal Finish</b>	100% Matte Tin-plated
<b>Body Material</b>	UL recognized epoxy meeting flammability classification 94V-0
<b>Terminal Material</b>	Copper Alloy

**Design Considerations**

Careful selection of the correct device for the application's operating parameters and environment will go a long way toward extending the operating life of the Thyristor. Good design practice should limit the maximum continuous current through the main terminals to 75% of the device rating. Other ways to ensure long life for a power discrete semiconductor are proper heat sinking and selection of voltage ratings for worst case conditions. Overheating, overvoltage (including dv/dt), and surge currents are the main killers of semiconductors. Correct mounting, soldering, and forming of the leads also help protect against component damage.

**Environmental Specifications**

Test	Specifications and Conditions
<b>AC Blocking (<math>V_{DRM}</math>)</b>	MIL-STD-750, M-1040, Cond A Applied Peak AC voltage @ 125°C for 1008 hours
<b>Temperature Cycling</b>	MIL-STD-750, M-1051, 100 cycles; -40°C to +150°C; 15-min dwell-time
<b>Temperature/Humidity</b>	EIA / JEDEC, JESD22-A101 1008 hours; 320V - DC: 85°C; 85% rel humidity
<b>High Temp Storage</b>	MIL-STD-750, M-1031, 1008 hours; 150°C
<b>Low-Temp Storage</b>	1008 hours; -40°C
<b>Thermal Shock</b>	MIL-STD-750, M-1056 10 cycles; 0°C to 100°C; 5-min dwell-time at each temperature; 10 sec (max) transfer time between temperature
<b>Autoclave</b>	EIA / JEDEC, JESD22-A102 168 hours (121°C at 2 ATMs) and 100% R/H
<b>Resistance to Solder Heat</b>	MIL-STD-750 Method 2031
<b>Solderability</b>	ANSI/J-STD-002, category 3, Test A
<b>Lead Bend</b>	MIL-STD-750, M-2036 Cond E



**Dimensions — TO-220AB (R-Package) — Non-Isolated Mounting Tab Common with Center Lead**



Dimension	Inches		Millimeters	
	Min	Max	Min	Max
A	0.380	0.420	9.65	10.67
B	0.105	0.115	2.67	2.92
C	0.230	0.250	5.84	6.35
D	0.590	0.620	14.99	15.75
E	0.142	0.147	3.61	3.73
F	0.110	0.130	2.79	3.30
G	0.540	0.575	13.72	14.61
H	0.025	0.035	0.64	0.89
J	0.195	0.205	4.95	5.21
K	0.095	0.105	2.41	2.67
L	0.060	0.075	1.52	1.91
M	0.085	0.095	2.16	2.41
N	0.018	0.024	0.46	0.61
O	0.178	0.188	4.52	4.78
P	0.045	0.060	1.14	1.52
R	0.038	0.048	0.97	1.22

**Dimensions — TO-220AB (L-Package) — Isolated Mounting Tab**



Dimension	Inches		Millimeters	
	Min	Max	Min	Max
A	0.380	0.420	9.65	10.67
B	0.105	0.115	2.67	2.92
C	0.230	0.250	5.84	6.35
D	0.590	0.620	14.99	15.75
E	0.142	0.147	3.61	3.73
F	0.110	0.130	2.79	3.30
G	0.540	0.575	13.72	14.61
H	0.025	0.035	0.64	0.89
J	0.195	0.205	4.95	5.21
K	0.095	0.105	2.41	2.67
L	0.060	0.075	1.52	1.91
M	0.085	0.095	2.16	2.41
N	0.018	0.024	0.46	0.61
O	0.178	0.188	4.52	4.78
P	0.045	0.060	1.14	1.52
R	0.038	0.048	0.97	1.22

### Dimensions — TO-263AB (N-Package) — D<sup>2</sup>-PAK Surface Mount

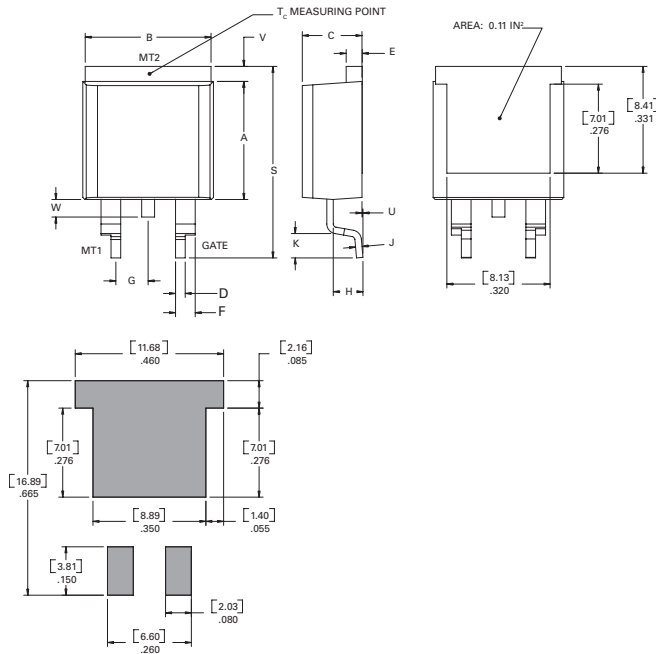

Dimension	Inches		Millimeters	
	Min	Max	Min	Max
A	0.360	0.370	9.14	9.40
B	0.380	0.420	9.65	10.67
C	0.178	0.188	4.52	4.78
D	0.025	0.035	0.64	0.89
E	0.045	0.060	1.14	1.52
F	0.060	0.075	1.52	1.91
G	0.095	0.105	2.41	2.67
H	0.092	0.102	2.34	2.59
J	0.018	0.024	0.46	0.61
K	0.090	0.110	2.29	2.79
S	0.590	0.625	14.99	15.88
V	0.035	0.045	0.89	1.14
U	0.002	0.010	0.05	0.25
W	0.040	0.070	1.02	1.78

### Dimensions — TO-251AA (V-Package) — V-PAK Through Hole



Dimension	Inches			Millimeters		
	Min	Typ	Max	Min	Typ	Max
A	0.040	0.044	0.050	1.02	1.11	1.27
B	0.235	0.242	0.245	5.97	6.15	6.22
C	0.350	0.361	0.375	8.89	9.18	9.53
D	0.205	0.208	0.213	5.21	5.29	5.41
E	0.255	0.262	0.265	6.48	6.66	6.73
F	0.027	0.031	0.033	0.69	0.80	0.84
G	0.087	0.090	0.093	2.21	2.28	2.36
H	0.085	0.092	0.095	2.16	2.34	2.41
I	0.176	0.180	0.184	4.47	4.57	4.67
J	0.018	0.020	0.023	0.46	0.51	0.58
K	0.038	0.040	0.044	0.97	1.01	1.12
L	0.018	0.020	0.023	0.46	0.52	0.58
P	0.042	0.047	0.052	1.06	1.20	1.32
Q	0.034	0.039	0.044	0.86	1.00	1.11
R	0.034	0.039	0.044	0.86	1.00	1.11
S	0.074	0.079	0.084	1.86	2.00	2.11

**Dimensions — TO-252AA (D-Package) — D-PAK Surface Mount**



Dimension	Inches			Millimeters		
	Min	Typ	Max	Min	Typ	Max
A	0.040	0.043	0.050	1.02	1.09	1.27
B	0.235	0.243	0.245	5.97	6.16	6.22
C	0.106	0.108	0.113	2.69	2.74	2.87
D	0.205	0.208	0.213	5.21	5.29	5.41
E	0.255	0.262	0.265	6.48	6.65	6.73
F	0.027	0.031	0.033	0.69	0.80	0.84
G	0.087	0.090	0.093	2.21	2.28	2.36
H	0.085	0.092	0.095	2.16	2.33	2.41
I	0.176	0.179	0.184	4.47	4.55	4.67
J	0.018	0.020	0.023	0.46	0.51	0.58
K	0.038	0.040	0.044	0.97	1.02	1.12
L	0.018	0.020	0.023	0.46	0.51	0.58
M	0.000	0.000	0.004	0.00	0.00	0.10
N	0.021	0.026	0.027	0.53	0.67	0.69
O	0°	0°	5°	0°	0°	5°
P	0.042	0.047	0.052	1.06	1.20	1.32
Q	0.034	0.039	0.044	0.86	1.00	1.11

**Product Selector**

Part Number	Voltage (xx)				Gate Sensitivity Quadrants		Type	Package
	400V	600V	800V	1000V	I – II – III	IV		
Lxx08L6	X	X			5 mA	10 mA	Sensitive Triac	TO-220L
Lxx08D6	X	X			5 mA	10 mA	Sensitive Triac	TO-252 D-PAK
Lxx08R6	X	X			5mA	10mA	Sensitive Triac	TO-220R
Lxx08V6	X	X			5 mA	10 mA	Sensitive Triac	TO-251 V-PAK
Lxx08L8	X	X			10 mA	20 mA	Sensitive Triac	TO-220L
Lxx08D8	X	X			10 mA	20 mA	Sensitive Triac	TO-252 D-PAK
Lxx08R8	X	X			10mA	20mA	Sensitive Triac	TO-220R
Lxx08V8	X	X			10 mA	20 mA	Sensitive Triac	TO-251 V-PAK
Qxx08RH3	X	X			10 mA		Alternistor Triac	TO-220R
Qxx08VH3	X	X			10 mA		Alternistor Triac	TO-251 V-PAK
Qxx08DH3	X	X			10 mA		Alternistor Triac	TO-252 D-PAK
Qxx08L4	X				25 mA		Triac	TO-220L
Qxx08R4	X				25 mA		Triac	TO-220R
Qxx08N4	X				25 mA		Triac	TO-263 D <sup>2</sup> -PAK
Qxx08LH4	X	X	X	X	35 mA		Alternistor Triac	TO-220L
Qxx08RH4	X	X	X	X	35 mA		Alternistor Triac	TO-220R
Qxx08VH4	X	X	X	X	35 mA		Alternistor Triac	TO-251 V-PAK
Qxx08DH4	X	X	X	X	35 mA		Alternistor Triac	TO-252 D-PAK
Qxx08NH4	X	X	X	X	35 mA		Alternistor Triac	TO-263 D <sup>2</sup> -PAK
Qxx08L5		X	X	X	50 mA		Triac	TO-220L
Qxx08R5		X	X	X	50 mA		Triac	TO-220R
Qxx08N5		X	X	X	50 mA		Triac	TO-263 D <sup>2</sup> -PAK

**Packing Options**

Part Number	Marking	Weight	Packing Mode	Base Quantity
L/Qxx08L/Ryy	L/Qxx08L/Ryy	2.2 g	Bulk	500
L/Qxx08L/RyyTP	L/Qxx08L/Ryy	2.2 g	Tube Pack	500 (50 per tube)
Qxx08NyyTP	Qxx08Nyy	1.6 g	Tube	500 (50 per tube)
Qxx08NyyRP	Qxx08Nyy	1.6 g	Embossed Carrier	500
L/Qxx08DyyTP	L/Qxx08Dyy	0.3 g	Tube	750 (75 per tube)
L/Qxx08DyyRP	L/Qxx08Dyy	0.3 g	Embossed Carrier	2500
L/Qxx08VyyTP	L/Qxx08Vyy	0.4 g	Tube	750 (75 per tube)

Note: xx = voltage, x = package, y = sensitivity, yy = type & sensitivity

**TO-252 Embossed Carrier Reel Pack (RP) Specifications**

Meets all EIA-481-2 Standards

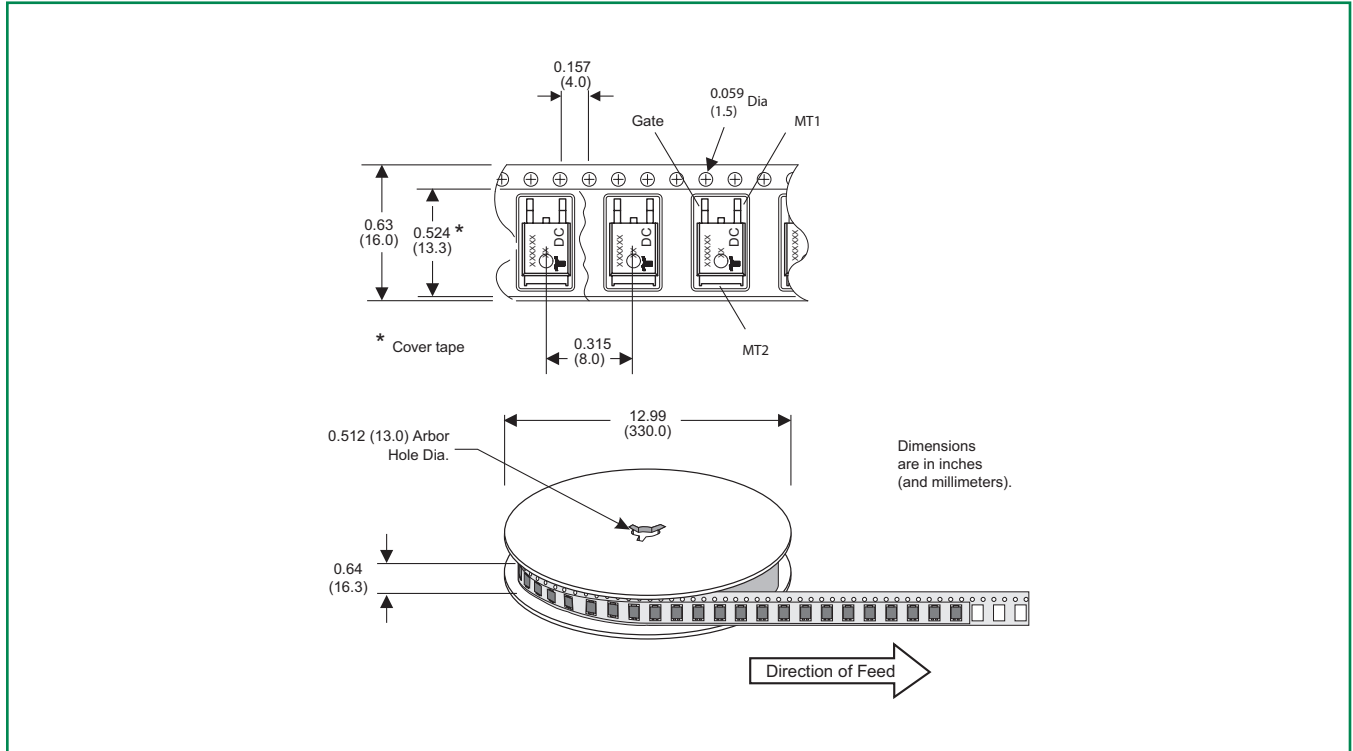

**TO-263 Embossed Carrier Reel Pack (RP) Specifications**

Meets all EIA-481-2 Standards



### Part Numbering System



### Part Marking System

TO-220 AB – (R Package)  
 TO-263 AB – (N Package)

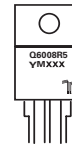

TO-252AA – (D Package)  
 TO-251AA – (V Package)

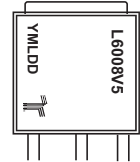

TO-220 AB – (L Package)





## Стандарт Электрон Связь

Мы молодая и активно развивающаяся компания в области поставок электронных компонентов. Мы поставляем электронные компоненты отечественного и импортного производства напрямую от производителей и с крупнейших складов мира.

Благодаря сотрудничеству с мировыми поставщиками мы осуществляем комплексные и плановые поставки широчайшего спектра электронных компонентов.

Собственная эффективная логистика и склад в обеспечивает надежную поставку продукции в точно указанные сроки по всей России.

Мы осуществляем техническую поддержку нашим клиентам и предпродажную проверку качества продукции. На все поставляемые продукты мы предоставляем гарантию .

Осуществляем поставки продукции под контролем ВП МО РФ на предприятия военно-промышленного комплекса России , а также работаем в рамках 275 ФЗ с открытием отдельных счетов в уполномоченном банке. Система менеджмента качества компании соответствует требованиям ГОСТ ISO 9001.

Минимальные сроки поставки, гибкие цены, неограниченный ассортимент и индивидуальный подход к клиентам являются основой для выстраивания долгосрочного и эффективного сотрудничества с предприятиями радиоэлектронной промышленности, предприятиями ВПК и научно-исследовательскими институтами России.

С нами вы становитесь еще успешнее!

### Наши контакты:

**Телефон:** +7 812 627 14 35

**Электронная почта:** [sales@st-electron.ru](mailto:sales@st-electron.ru)

**Адрес:** 198099, Санкт-Петербург,  
Промышленная ул, дом № 19, литера Н,  
помещение 100-Н Офис 331