

E3S-R

Ideal for Detecting Glass Wafers and Other Transparent Objects

- Detects glass wafers and LCD glass circuit boards.



(Compact models with plastic housing only)

Be sure to read *Safety Precautions* on page 7.

Ordering Information

Sensors

Compact Models with Plastic Housing (Refer to *Dimensions* on page 8.)

Red light Infrared light





Sensing method	Appearance	Connection method	Sensing distance	Model		Recommended application *2	
				NPN	PNP	Flat object	Cylindrical object
						Detecting glass wafers and LCD glass circuit boards	Detecting plastic bottles and other transparent containers
Retro-reflective	Horizontal	Pre-wired (2 m)	300 mm [100 mm] *1	E3S-R12 2M	---	Ideal	Ideal
			1 m [100 mm] *1	E3S-R11 2M	E3S-R31 2M	Ideal	---
		Standard M12 Connector	300 mm [100 mm] *1	E3S-R17	---	Ideal	Ideal
			1 m [100 mm] *1	E3S-R16	E3S-R36	Ideal	---
	Vertical	Pre-wired (2 m)	300 mm [100 mm] *1	E3S-R62 2M	---	Ideal	Ideal
			1 m [100 mm] *1	E3S-R61 2M	E3S-R81 2M	Ideal	---
		Standard M12 Connector	300 mm [100 mm] *1	E3S-R67	---	Ideal	Ideal
			1 m [100 mm] *1	E3S-R66	E3S-R86	Ideal	---

*1. Values in parentheses indicate the minimum required distance between the Sensor and Reflector.

*2. The E3S-R may not detect some glass wafer materials or plastic bottle shapes. Before using the E3S-R, be sure to test it on samples to make sure it can detect the items reliably.

Models with Metal Housing (Refer to Dimensions on page 10.)

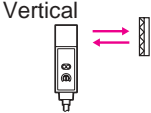
 Red light

Sensing method	Appearance	Connection method	Sensing distance		Model	Recommended application *	
						Flat object	Cylindrical object
						Detecting glass wafers and LCD glass circuit boards	Detecting plastic bottles and other transparent containers
Retro-reflective	Horizontal 	Pre-wired	 300 mm		E3S-RS30E4	---	Ideal
				1 m	E3S-R1E4	---	Applicable
	Vertical 		 300 mm		E3S-RS30E42	---	Ideal
				1 m	E3S-R1E42	---	Applicable

* The E3S-R may not detect some glass wafer materials or plastic bottle shapes. Before using the E3S-R, be sure to test it on samples to make sure it can detect the items reliably.

Accessories (Order Separately)

Sensitivity Adjuster/Screwdriver (Refer to Dimensions on E39-L/F39-L/E39-S/E39-R.)







Name	Model	Quantity	Remarks
Sensitivity adjuster	E39-G1	1	Provided with the E3S-RS30E4□ and E3S-R1E4□.
Screwdriver for sensitivity adjustment	E39-G2	1	Provided with the E3S-R1□, E3S-R3□, E3S-R6□, and E3S-R8□.

Reflector (Refer to Dimensions on E39-L/F39-L/E39-S/E39-R.)

Name	Sensing distance	Model	Quantity	Remarks
Reflector	Refer to Ratings and Specifications.	E39-R1	1	Provided with the E3S-R.

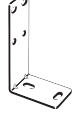

Note: Refer to Reflectors on E39-L/F39-L/E39-S/E39-R for details.

Mounting Brackets and Other Products (Refer to Dimensions on E39-L/F39-L/E39-S/E39-R.)

Appearance	Model	Quantity	Remarks
	E39-L69	1	Provided with the E3S-R1□ and E3S-R3□.
	E39-L70	1	Provided with the E3S-R6□ and E3S-R8□.
	E39-L6	1	Provided with the E3S-RS30E4□ and E3S-R1E4□.
	E39-L2	1	Can be used with the E3S-RS30E4□ and E3S-R1E4□.
	E39-L97	1	Horizontal protective cover bracket Can be used for compact models with plastic housing. Refer to E39-L□.
	E39-L98	1	Vertical protective cover bracket Can be used for compact models with plastic housing. Refer to E39-L□.
	E39-L60	1	Close Mounting Plate Provided with the E3S-R□6 and E3S-R□7.

Note: 1. When using through-beam models, order one bracket for the Receiver and one for the Emitter.
2. Refer to Mounting Brackets on E39-L/F39-L/E39-S/E39-R for details.

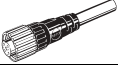
Sensor I/O Connectors (M12) (Refer to Dimensions on XS2.)

Cable	Appearance	Cable type		Model
Standard	Straight 	2 m	3-wire	XS2F-D421-DC0-A
		5 m		XS2F-D421-GC0-A
	L-shape 	2 m		XS2F-D422-DC0-A
		5 m		XS2F-D422-GC0-A

Note: For details on Sensor I/O Connectors and cables such as vibration-proof robot cables, refer to *Introduction to Sensor I/O Connectors*.

Ratings and Specifications

Item	Sensing method Model	Retro-reflective	Retro-reflective (with MSR function) *1	Retro-reflective	
		NPN	E3S-R11, R16, R61, R66	E3S-RS30E4, RS30E42	E3S-R1E4, R1E42
		PNP	---	---	---
Sensing distance		300 mm [100 mm] *2 (When using E39-R1)	1 m [100 mm] *2 (When using E39-R1)	300 mm (When using E39-R1)	1 m (When using E39-R1)
Standard sensing object		Opaque: 75-mm dia. min. 0.7-mm-thick LCD glass boards; 10-mm-dia., 1.0-mm-thick, 30-mm-long cylindrical glass objects	Opaque: 75-mm dia. min. 0.7-mm-thick LCD glass boards	Opaque: 75-mm dia. min. 10-mm-dia., 1.0-mm-thick, 30-mm-long cylindrical glass objects	
Directional angle		3° to 10°		---	
Light source (wavelength)		Infrared LED (880 nm)	Red LED (700 nm)	Infrared LED (950 nm)	
Power supply voltage		10 to 30 VDC; ripple: 10% max.		12 to 24 VDC±10%; ripple: 10% max.	
Current consumption		30 mA max.		40 mA max.	
Control output		Load power supply voltage: 30 VDC max. Load current: 100 mA max. with a maximum residual voltage of 1 V Open collector output configuration Light-ON/Dark-ON selector switch		Load power supply voltage: 24 VDC max Load current: 80 mA max. with a maximum residual voltage of 2 V NPN voltage output configuration Light-ON/Dark-ON cable connection selection	
Protection circuits		Power supply reverse polarity protection, Output short-circuit protection, Mutual interference prevention			
Response time		Operate or reset: 1 ms max.			
Sensitivity adjustment		Two-turn endless adjuster		One-turn adjuster	
Ambient illumination (Receiver side)		Incandescent lamp: 5,000 lx max. Sunlight: 10,000 lx max.		Incandescent lamp: 3,000 lx max. Sunlight: 10,000 lx max.	
Ambient temperature range		Operating: 0 to 40°C, Storage: -40 to 70°C (with no icing or condensation)			Operating: -25 to 55°C Storage: -40 to 70°C (with no icing or condensation)
Ambient humidity range		Operating: 35% to 85%, Storage: 35% to 95% (with no condensation)			
Insulation resistance		20 MΩ min. (at 500 VDC)			
Dielectric strength		1,000 VAC, 50/60 Hz for 1 min			
Vibration resistance		Destruction: 10 to 55 Hz, 1.5-mm double amplitude for 2 h each in X, Y, and Z directions			
Shock resistance		Destruction: 500 m/s ² for 3 times each in X, Y, and Z directions			
Degree of protection		IEC 60529 IP67			
Connection method		Pre-wired (standard length: 2 m)/Standard connector			
Weight (packed state)		Pre-wired models: Approx. 110 g Standard connector: Approx. 60 g		Pre-wired models: Approx. 190 g	
Materials	Case	Polybutylene terephthalate		Zinc die-cast	
	Lens	Modified polyallylate		Polycarbonate	
	Mounting Bracket	Stainless steel (SUS304)		Iron	
Accessories		Mounting Bracket (with screw), Adjustment screwdriver, Instruction manual, Reflector		Mounting Bracket (with screw), Adjustment screwdriver, Sensitivity adjuster, Instruction manual, Reflector	

*1. Refer to MSR function of *Technical Guide (Technical version)*.

*2. Values in parentheses indicate the minimum required distance between the Sensor and Reflector.

Engineering Data (Typical)

Parallel Operating Range

Retro-reflective

E3S-R12, E3S-R62 + E39-R1
(Supplied Reflector)

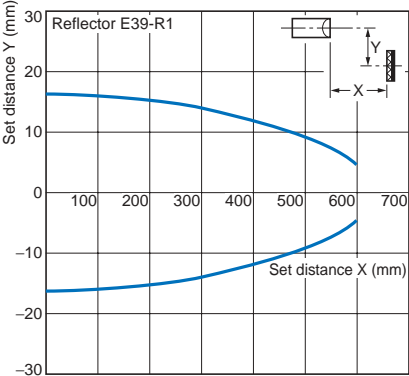

Retro-reflective

E3S-R□1, E3S-R□6 + E39-R1
(Supplied Reflector)

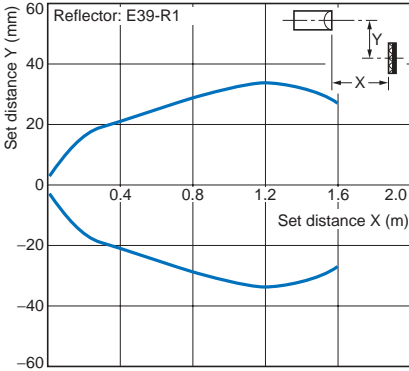

Retro-reflective

E3S-RS30E4□ + E39-R1
(Supplied Reflector)

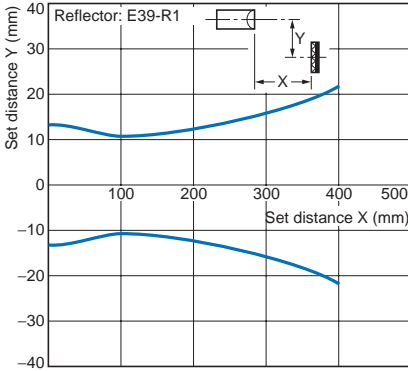

Retro-reflective

E3S-R1E4□ + E39-R1
(Supplied Reflector)

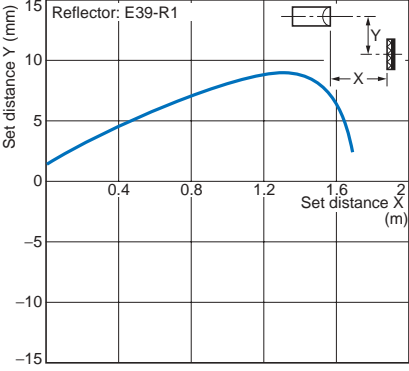

Excess Gain vs. Set Distance

E3S-R12, E3S-R62 + E39-R1
(Supplied Reflector)

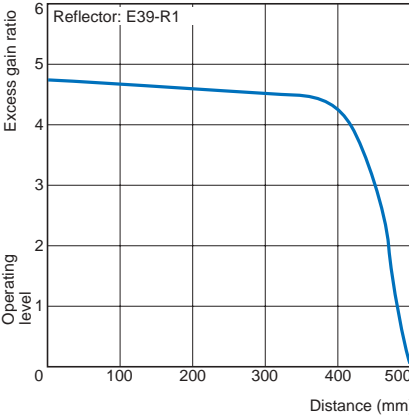

E3S-R□1, E3S-R□6 + E39-R1
(Supplied Reflector)

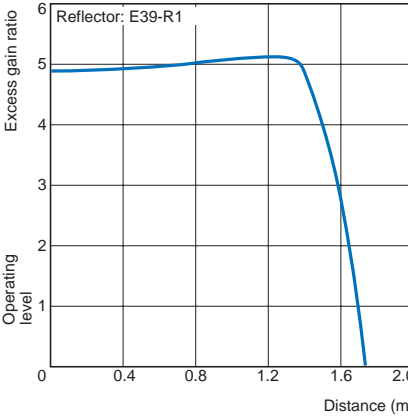

E3S-RS30E4□ + E39-R1
(Supplied Reflector)

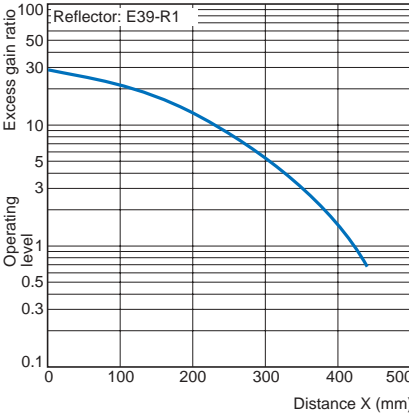

E3S-R1E4□ + E39-R1
(Supplied Reflector)

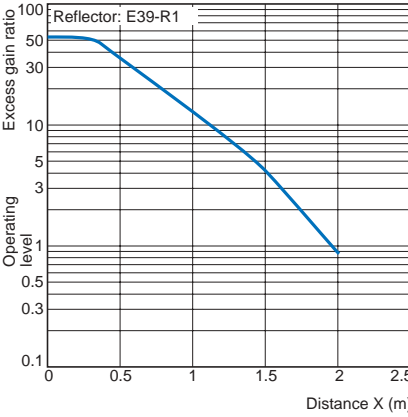

Light Level Change Rates with Various Transparent Objects (*1)

The following are the permeation rates of various transparent objects on condition that a permeation rate of 100 means that there is no object within the sensing distance of the E3S-R. The permeation rate of any type of object sensed by the E3S-R must be as low as possible for reliable detection of the object. Before using the E3S-R, be sure to test it on samples to make sure it can detect the items reliably.

Sensing object Appearance	Model Through position	E3S-R12, R62 E3S-R17, R67	E3S-R11, R31, R61, R81 E3S-R16, R36, R66, R86	E3S-RS30□□	E3S-R1□□
		Center	Center	Center	Center
Cylindrical glass object	10 dia. × 30, t = 1.0	27	---	20	33
	15 dia. × 30, t = 1.25	27	---	20	13
	20 dia. × 30, t = 1.7	22	---	28	13
	30 dia. × 30, t = 1.9	41	---	43	23
	100 dia. × 30, t = 2.5	58	---	55	50
	200 dia. × 30, t = 5.0	55	---	58	58
Glass plate	50 × 50, t = 0.5	82	82	78	---
	50 × 50, t = 1	74	74	70	75
	50 × 50, t = 2	73	73	70	75
	50 × 50, t = 3	62	62	58	65
	50 × 50, t = 5	53	53	50	55
	50 × 50, t = 10	38	38	35	40
Liquid crystal glass	t = 0.5 (permeability of 98%)*2	86	86	---	---
	t = 0.7 (permeability of 95%)*2	81	81	---	---
	t = 1.1 (permeability of 91%)*2	75	75	---	---
Operating range		95 max.	95 max.	90 max.	80 max.
Stable operating range		90 max.	90 max.	70 max.	60 max.

*1. The sensing distance of each model was set to the rated sensing distance.
*2. The permeability values were checked with light at a wavelength of 700 μm.

I/O Circuit Diagrams

NPN Output

Model	Operation mode	Timing Charts	Operation selector	Output circuit
E3S-R11(12) E3S-R61(62) E3S-R16(17) E3S-R66(67)	Light-ON	<p>Incident light No incident light Light indicator (Red) ON OFF Output transistor ON OFF Load (e.g., relay) Operate Reset (Between brown and black leads)</p>	L side (LIGHT ON)	<p>Connector Pin Arrangement</p> <p>Note: Pin 2 is not used.</p>
	Dark-ON	<p>Incident light No incident light Light indicator (Red) ON OFF Output transistor ON OFF Load (e.g., relay) Operate Reset (Between brown and black leads)</p>	D side (DARK ON)	

PNP Output

Model	Operation mode	Timing Charts	Operation selector	Output circuit
E3S-R31 E3S-R36 E3S-R81 E3S-R86	Light-ON		L side (LIGHT ON)	
	Dark-ON		D side (DARK ON)	

Plug (Sensor I/O Connector)

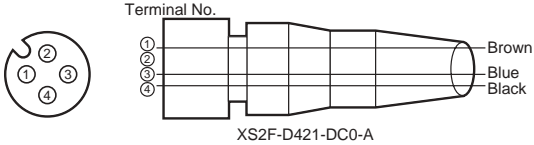

Classification	Wire color	Connection pin No.	Application
DC	Brown	1	Power supply (+V)
	---	2	---
	Blue	3	Power supply (0 V)
	Black	4	Output

Refer to *Introduction to Sensor I/O connectors* for details.

Note: Pin 2 is not used.

Model	Operation mode	Timing Charts	Cable Connection	Output circuit
E3S-RS30E4(42) E3S-R1E4(42)	Light-ON		Brown cable: +V Blue cable: 0 V	
	Dark-ON		Brown cable: 0 V Blue cable: +V	

*1. Reverse the polarity of the power supply to change the output mode of the E3S-R.

*2. Voltage output (When connecting a transistor circuit, etc.)

Safety Precautions

Refer to *Warranty and Limitations of Liability*.

WARNING

This product is not designed or rated for ensuring safety of persons either directly or indirectly. Do not use it for such purposes.



Precautions for Correct Use

Do not use the product in atmospheres or environments that exceed product ratings.

● Adjusting

- When the E3S-R senses a cylindrical object, the amount of light received varies with the direction of the cylindrical object. To prevent this, locate the E3S-R as shown in the following illustration.

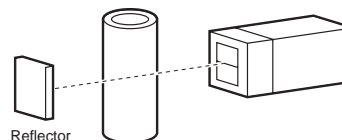

- When the E3S-R senses an uneven plastic container or glass bottle, the amount of light received varies with the direction and sensing part of the plastic container or glass bottle. To prevent this, turn a sample of the plastic container or glass bottle to the best sensing position of the E3S-R to find and decide the optimum direction and sensing part, and then make the sensitivity adjustment.
- In principle, sensing objects must pass through the center between the E3S-R and the reflector. Sensing objects must not be too close to the Reflector, otherwise sensing errors may result.
- Unless otherwise indicated, the E39-R1 Reflector is required for transparent object detection. The Receiver may not receive any light and detection capability may decline with other Reflectors.

Dimensions

Sensors

Compact Horizontal Models with Plastic Housing

Pre-wired Models

E3S-R11, E3S-R12

E3S-R31

With Mounting Bracket Attached

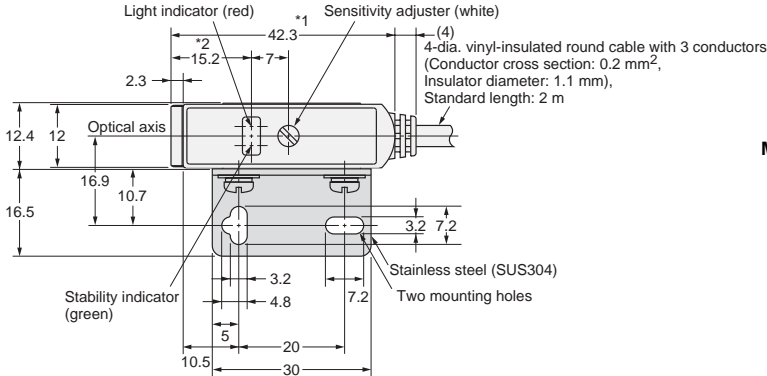
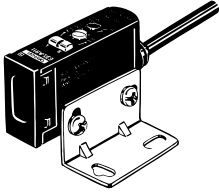

Mounting Holes

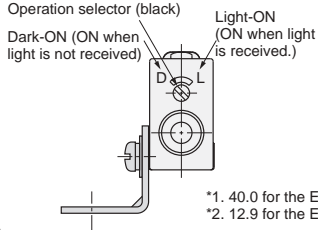
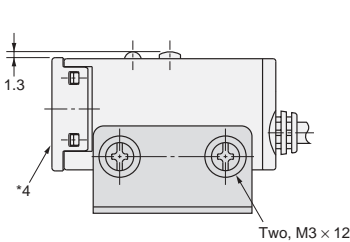
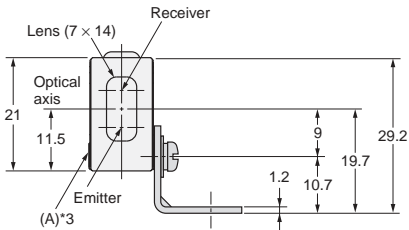
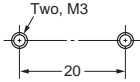

*3. The mounting bracket can be attached to this side.
*4. Not available on the E3S-R12.

Standard Connector Models

E3S-R16, E3S-R17

E3S-R36

With Mounting Bracket Attached

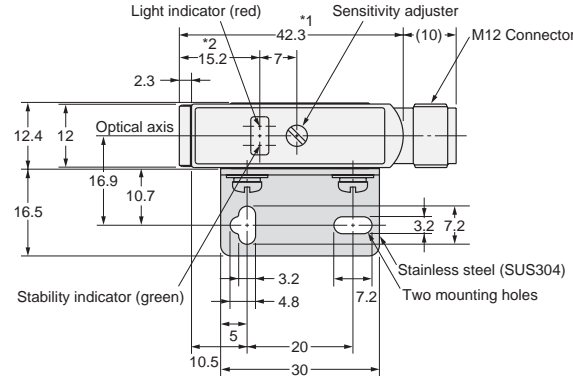
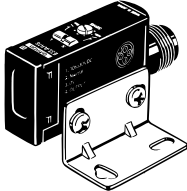

Mounting Holes

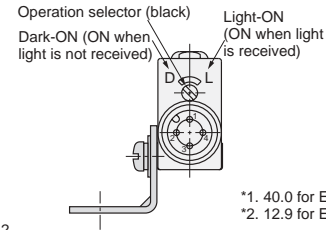
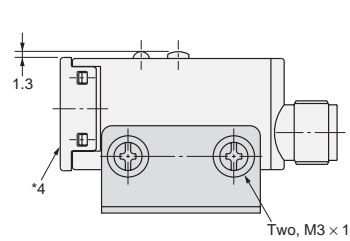
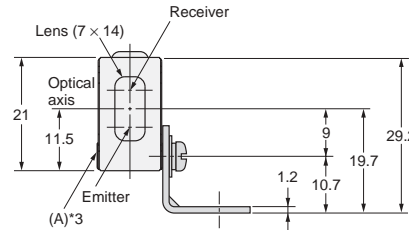
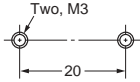

*3. The mounting bracket can be attached to this side.
*4. Not available on the E3S-R17.

Compact Vertical Models with Plastic Housing

Pre-wired Models
E3S-R61, E3S-R62
E3S-R81

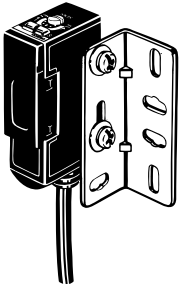

With Mounting Bracket Attached

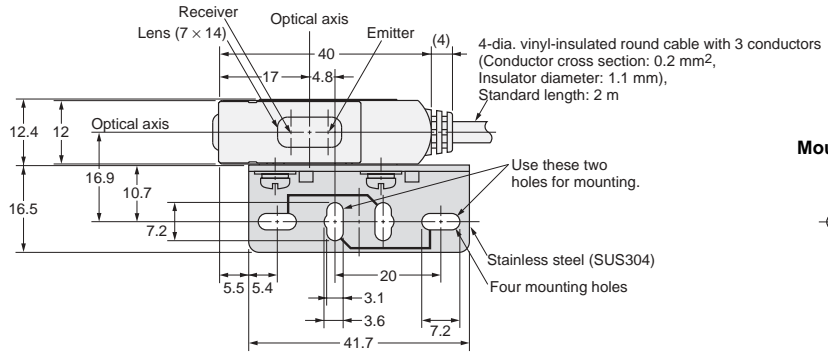

Mounting Holes

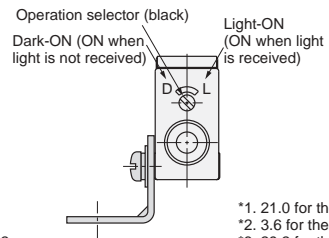
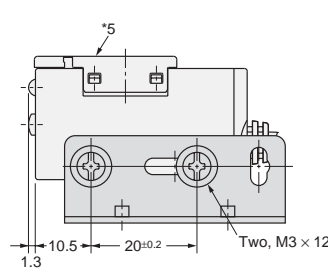
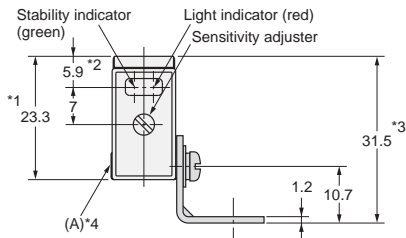
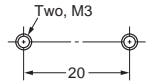

*1. 21.0 for the E3S-R62.
*2. 3.6 for the E3S-R62.
*3. 29.2 for the E3S-R62.

*4. The mounting bracket can be attached to this side.
*5. Not available on the E3S-R62.

Standard Connector Models
E3S-R66, E3S-R67
E3S-R86

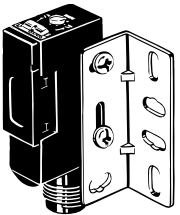

With Mounting Bracket Attached

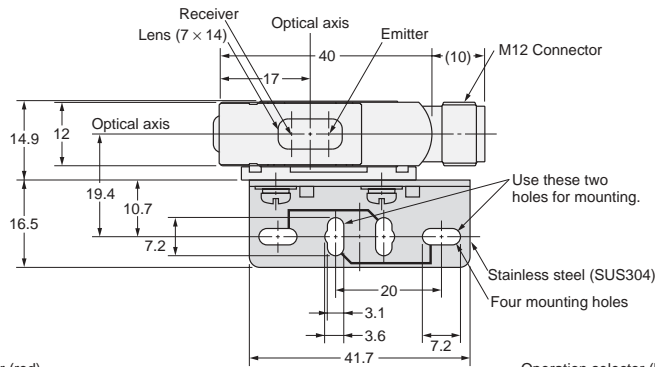

Mounting Holes

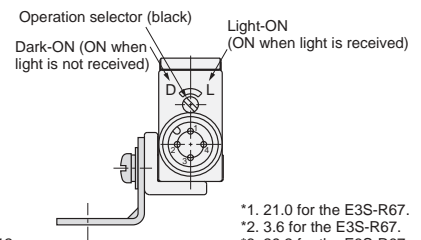
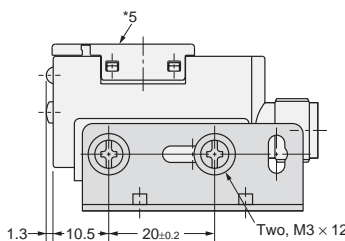
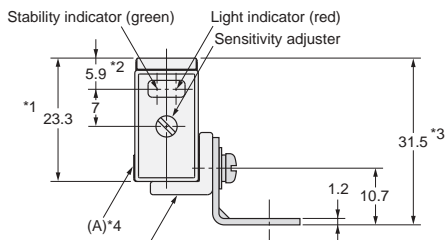
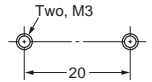

*1. 21.0 for the E3S-R67.
*2. 3.6 for the E3S-R67.
*3. 29.2 for the E3S-R67.

E39-L60 Close Mounting Plate (provided)
(Attach the mounting plate or the
plug cannot be connected.)

*4. The mounting bracket can be attached to this side.
*5. Not available on the E3S-R67.

Horizontal Models with Metal Housing

E3S-RS30E4
E3S-R1E4

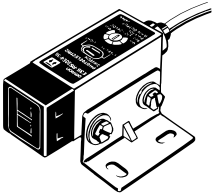

With Mounting Bracket Attached

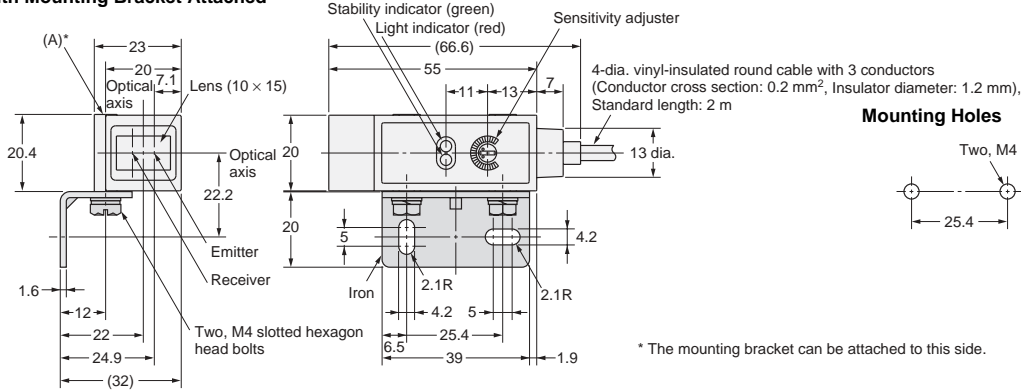

Vertical Models with Metal Housing

E3S-RS30E42
E3S-R1E42

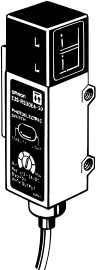

With Mounting Bracket Attachment

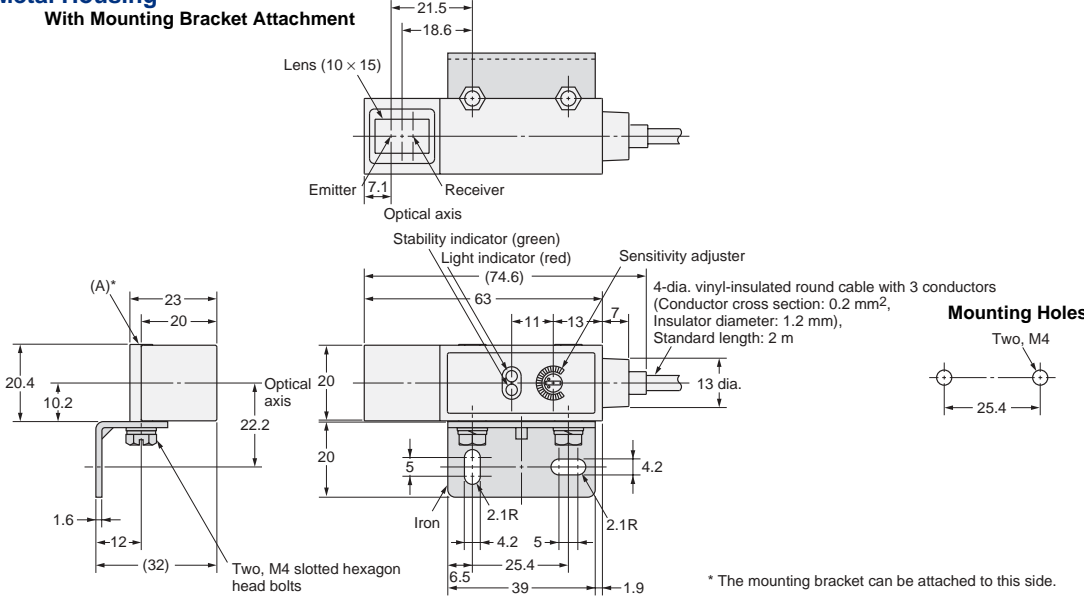

Accessories (Order Separately)

- Sensitivity Adjuster**
Refer to E39-L/F39-L/E39-S/E39-R for details.
- Reflectors**
Refer to E39-L/F39-L/E39-S/E39-R for details.
- Mounting Brackets**
Refer to E39-L/F39-L/E39-S/E39-R for details.
- Close Mounting Plates**
Refer to E39-L/F39-L/E39-S/E39-R for details.
- Sensor I/O Connectors**
Refer to Introduction to Sensor I/O Connectors for details.

Read and Understand This Catalog

Please read and understand this catalog before purchasing the products. Please consult your OMRON representative if you have any questions or comments.

Warranty and Limitations of Liability

WARRANTY

OMRON's exclusive warranty is that the products are free from defects in materials and workmanship for a period of one year (or other period if specified) from date of sale by OMRON.

OMRON MAKES NO WARRANTY OR REPRESENTATION, EXPRESS OR IMPLIED, REGARDING NON-INFRINGEMENT, MERCHANTABILITY, OR FITNESS FOR PARTICULAR PURPOSE OF THE PRODUCTS. ANY BUYER OR USER ACKNOWLEDGES THAT THE BUYER OR USER ALONE HAS DETERMINED THAT THE PRODUCTS WILL SUITABLY MEET THE REQUIREMENTS OF THEIR INTENDED USE. OMRON DISCLAIMS ALL OTHER WARRANTIES, EXPRESS OR IMPLIED.

LIMITATIONS OF LIABILITY

OMRON SHALL NOT BE RESPONSIBLE FOR SPECIAL, INDIRECT, OR CONSEQUENTIAL DAMAGES, LOSS OF PROFITS OR COMMERCIAL LOSS IN ANY WAY CONNECTED WITH THE PRODUCTS, WHETHER SUCH CLAIM IS BASED ON CONTRACT, WARRANTY, NEGLIGENCE, OR STRICT LIABILITY.

In no event shall the responsibility of OMRON for any act exceed the individual price of the product on which liability is asserted.

IN NO EVENT SHALL OMRON BE RESPONSIBLE FOR WARRANTY, REPAIR, OR OTHER CLAIMS REGARDING THE PRODUCTS UNLESS OMRON'S ANALYSIS CONFIRMS THAT THE PRODUCTS WERE PROPERLY HANDLED, STORED, INSTALLED, AND MAINTAINED AND NOT SUBJECT TO CONTAMINATION, ABUSE, MISUSE, OR INAPPROPRIATE MODIFICATION OR REPAIR.

Application Considerations

SUITABILITY FOR USE

OMRON shall not be responsible for conformity with any standards, codes, or regulations that apply to the combination of products in the customer's application or use of the products.

At the customer's request, OMRON will provide applicable third party certification documents identifying ratings and limitations of use that apply to the products. This information by itself is not sufficient for a complete determination of the suitability of the products in combination with the end product, machine, system, or other application or use.

The following are some examples of applications for which particular attention must be given. This is not intended to be an exhaustive list of all possible uses of the products, nor is it intended to imply that the uses listed may be suitable for the products:

- Outdoor use, uses involving potential chemical contamination or electrical interference, or conditions or uses not described in this catalog.
- Nuclear energy control systems, combustion systems, railroad systems, aviation systems, medical equipment, amusement machines, vehicles, safety equipment, and installations subject to separate industry or government regulations.
- Systems, machines, and equipment that could present a risk to life or property.

Please know and observe all prohibitions of use applicable to the products.

NEVER USE THE PRODUCTS FOR AN APPLICATION INVOLVING SERIOUS RISK TO LIFE OR PROPERTY WITHOUT ENSURING THAT THE SYSTEM AS A WHOLE HAS BEEN DESIGNED TO ADDRESS THE RISKS, AND THAT THE OMRON PRODUCTS ARE PROPERLY RATED AND INSTALLED FOR THE INTENDED USE WITHIN THE OVERALL EQUIPMENT OR SYSTEM.

PROGRAMMABLE PRODUCTS

OMRON shall not be responsible for the user's programming of a programmable product, or any consequence thereof.

Disclaimers

CHANGE IN SPECIFICATIONS

Product specifications and accessories may be changed at any time based on improvements and other reasons.

It is our practice to change model numbers when published ratings or features are changed, or when significant construction changes are made. However, some specifications of the products may be changed without any notice. When in doubt, special model numbers may be assigned to fix or establish key specifications for your application on your request. Please consult with your OMRON representative at any time to confirm actual specifications of purchased products.

DIMENSIONS AND WEIGHTS

Dimensions and weights are nominal and are not to be used for manufacturing purposes, even when tolerances are shown.

PERFORMANCE DATA

Performance data given in this catalog is provided as a guide for the user in determining suitability and does not constitute a warranty. It may represent the result of OMRON's test conditions, and the users must correlate it to actual application requirements. Actual performance is subject to the OMRON Warranty and Limitations of Liability.

ERRORS AND OMISSIONS

The information in this document has been carefully checked and is believed to be accurate; however, no responsibility is assumed for clerical, typographical, or proofreading errors, or omissions.

2010.10

In the interest of product improvement, specifications are subject to change without notice.

OMRON Corporation
Industrial Automation Company

<http://www.ia.omron.com/>

(c)Copyright OMRON Corporation 2010 All Right Reserved.



Стандарт Электрон Связь

Мы молодая и активно развивающаяся компания в области поставок электронных компонентов. Мы поставляем электронные компоненты отечественного и импортного производства напрямую от производителей и с крупнейших складов мира.

Благодаря сотрудничеству с мировыми поставщиками мы осуществляем комплексные и плановые поставки широчайшего спектра электронных компонентов.

Собственная эффективная логистика и склад в обеспечивает надежную поставку продукции в точно указанные сроки по всей России.

Мы осуществляем техническую поддержку нашим клиентам и предпродажную проверку качества продукции. На все поставляемые продукты мы предоставляем гарантию .

Осуществляем поставки продукции под контролем ВП МО РФ на предприятия военно-промышленного комплекса России , а также работаем в рамках 275 ФЗ с открытием отдельных счетов в уполномоченном банке. Система менеджмента качества компании соответствует требованиям ГОСТ ISO 9001.

Минимальные сроки поставки, гибкие цены, неограниченный ассортимент и индивидуальный подход к клиентам являются основой для выстраивания долгосрочного и эффективного сотрудничества с предприятиями радиоэлектронной промышленности, предприятиями ВПК и научно-исследовательскими институтами России.

С нами вы становитесь еще успешнее!

Наши контакты:

Телефон: +7 812 627 14 35

Электронная почта: sales@st-electron.ru

Адрес: 198099, Санкт-Петербург,
Промышленная ул, дом № 19, литера Н,
помещение 100-Н Офис 331