

Features

- Epitaxial Die Construction
- Ultra-Small Leadless Surface Mount Package
- Ultra Low Profile (0.4mm max)
- Complementary PNP Type Available (DP0150ALP4/DP0150BLP4)
- **“Lead Free”, RoHS Compliant (Note 1)**
- **Halogen and Antimony Free, “Green” Device (Note 2)**
- **Qualified to AEC-Q101 Standards for High Reliability**

Mechanical Data

- Case: DFN1006H4-3
- Case Material: Molded Plastic, "Green" Molding Compound. UL Flammability Classification Rating 94V-0
- Moisture Sensitivity: Level 1 per J-STD-020
- Terminals: Finish — NiPdAu over Copper leadframe. Solderable per MIL-STD-202, Method 208
- Weight: 0.0008 grams (approximate)

DFN1006H4-3

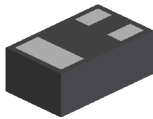

Bottom View

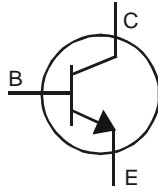

Device Symbol

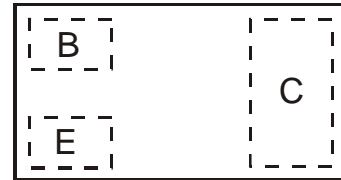

Top View
Pin Configuration

Ordering Information (Note 3)

Product	Marking	Reel size (inches)	Tape width (mm)	Quantity per reel
DN0150ALP4-7	T3	7	8	3,000
DN0150ALP4-7B	T3	7	8	10,000
DN0150BLP4-7	T4	7	8	3,000
DN0150BLP4-7B	T4	7	8	10,000

- Notes:
1. No purposefully added lead.
 2. Diodes Inc's "Green" policy can be found on our website at <http://www.diodes.com>
 3. For packaging details, go to our website at <http://www.diodes.com>.

Marking Information

DN0150ALP4-7
DN0150BLP4-7

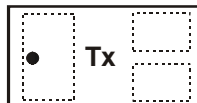

Top View
Dot Denotes
Collector Side

DN0150ALP4-7B
DN0150BLP4-7B

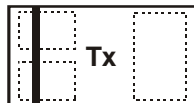

Top View
Bar Denotes Base
and Emitter Side

Tx = Product Type Marking Code
T5 = DN0150ALP4
T6 = DN0150BLP4

Maximum Ratings @ $T_A = 25^\circ\text{C}$ unless otherwise specified

Characteristic	Symbol	Value	Unit
Collector-Base Voltage	V_{CBO}	60	V
Collector-Emitter Voltage	V_{CEO}	50	V
Emitter-Base Voltage	V_{EBO}	5	V
Collector Current – Continuous	I_C	100	mA
Peak Pulse Collector Current	I_{CM}	200	mA
Base Current	I_B	30	mA

Thermal Characteristics

Characteristic	Symbol	Value	Unit
Power Dissipation (Note 4)	P_D	450	mW
Thermal Resistance, Junction to Ambient (Note 4)	$R_{\theta JA}$	278	$^\circ\text{C}/\text{W}$
Operating and Storage Temperature Range	T_J, T_{STG}	-55 to +150	$^\circ\text{C}$

Electrical Characteristics @ $T_A = 25^\circ\text{C}$ unless otherwise specified

Characteristic	Symbol	Min	Typ	Max	Unit	Test Condition	
OFF CHARACTERISTICS							
Collector-Base Breakdown Voltage	$V_{(BR)CBO}$	60	—	—	V	$I_C = 10\mu\text{A}, I_E = 0$	
Collector-Emitter Breakdown Voltage (Note 5)	$V_{(BR)CEO}$	50	—	—	V	$I_C = 1\text{mA}, I_B = 0$	
Emitter-Base Breakdown Voltage	$V_{(BR)EBO}$	5	—	—	V	$I_E = 10\mu\text{A}, I_C = 0$	
Collector Cut-Off Current	I_{CBO}	—	—	0.1	μA	$V_{CB} = 60\text{V}, I_E = 0$	
Emitter Cut-Off Current	I_{EBO}	—	—	0.1	μA	$V_{EB} = 5\text{V}, I_C = 0$	
ON CHARACTERISTICS (Note 5)							
Collector-Emitter Saturation Voltage	$V_{CE(SAT)}$	—	0.10	0.25	V	$I_C = 100\text{mA}, I_B = 10\text{mA}$	
DC Current Gain	h_{FE}	DN0150ALP4	120	—	240	—	$V_{CE} = 6\text{V}, I_C = 2\text{mA}$
		DN0150BLP4	200	—	400		
SMALL SIGNAL CHARACTERISTICS							
Transition Frequency	f_T	60	—	—	MHz	$V_{CE} = 10\text{V}, I_E = -1\text{mA}$ $f = 30\text{MHz}$	
Output Capacitance	C_{ob}	—	1.3	—	pF	$V_{CB} = 10\text{V}, I_E = 0,$ $f = 1\text{MHz}$	

- Notes:
- Device mounted on FR-4 PCB with minimum recommended pad layout.
 - Measured under pulsed conditions. Pulse width = 300 μs . Duty cycle $\leq 2\%$

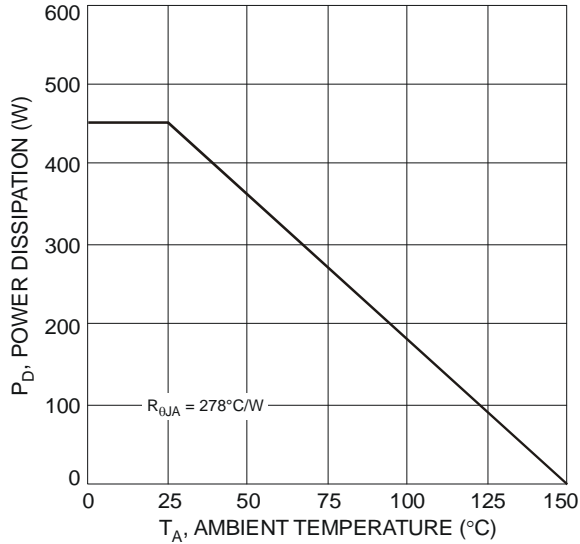

Fig. 1 Power Dissipation vs. Ambient Temperature (Note 3)

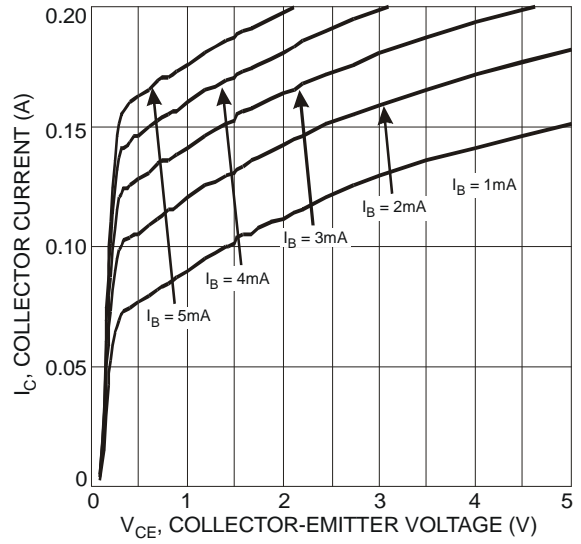

Fig. 2 Typical Collector Current vs. Collector-Emitter Voltage (DN0150BLP4)

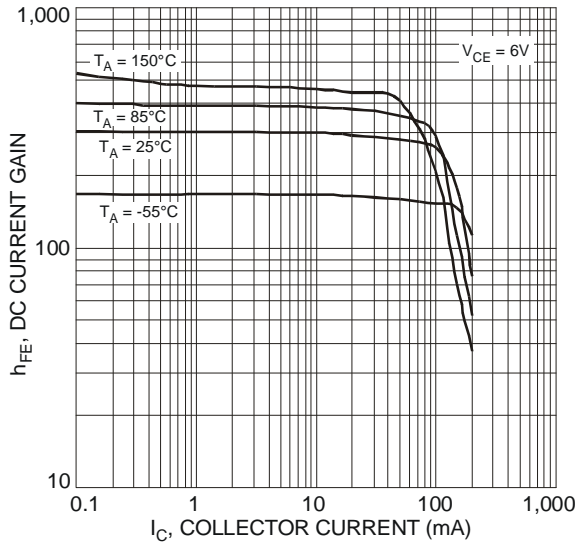

Fig. 3 Typical DC Current Gain vs. Collector Current (DN0150BLP4)

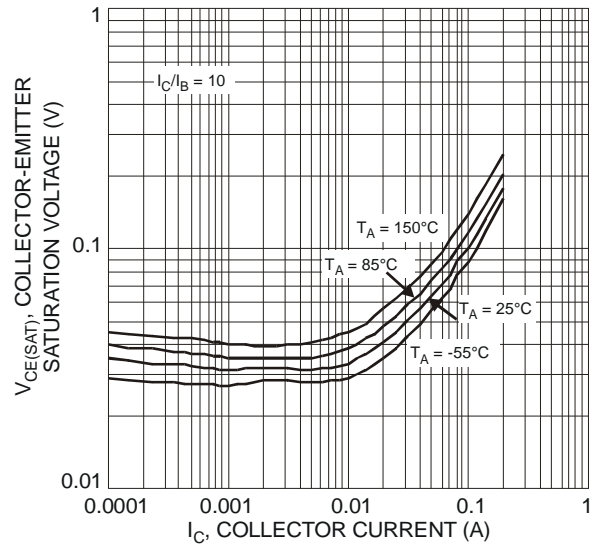

Fig. 4 Typical Collector-Emitter Saturation Voltage vs. Collector Current

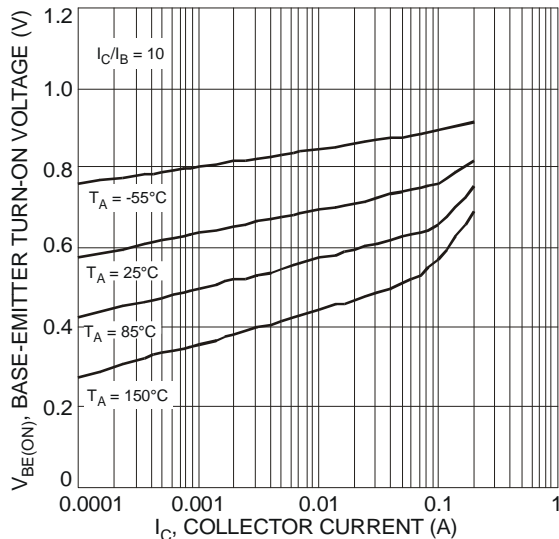

Fig. 5 Typical Base-Emitter Turn-On Voltage vs. Collector Current

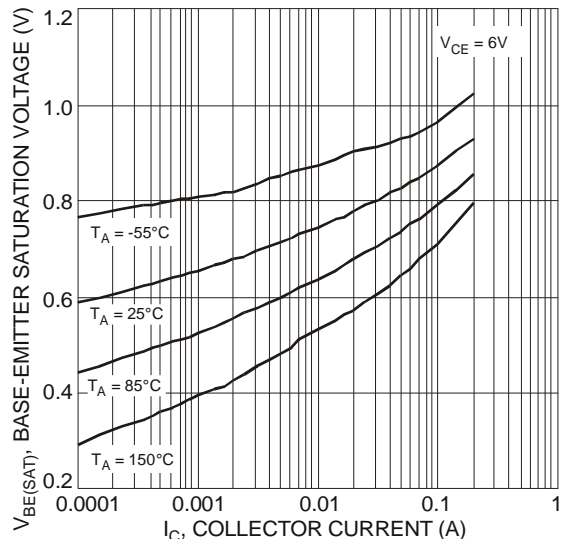

Fig. 6 Typical Base-Emitter Saturation Voltage vs. Collector Current

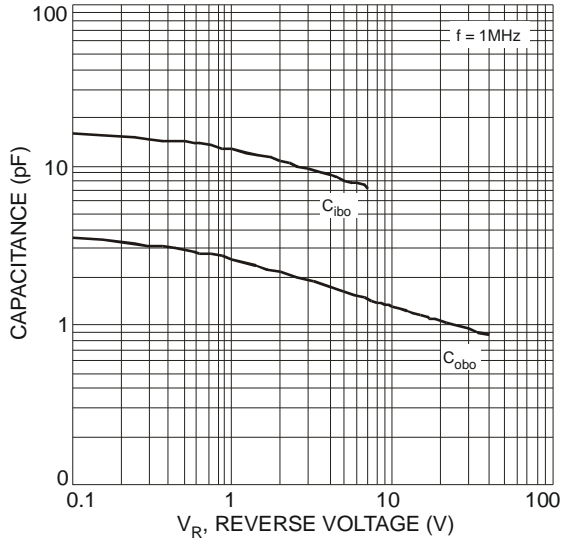

Fig. 7 Typical Capacitance Characteristics

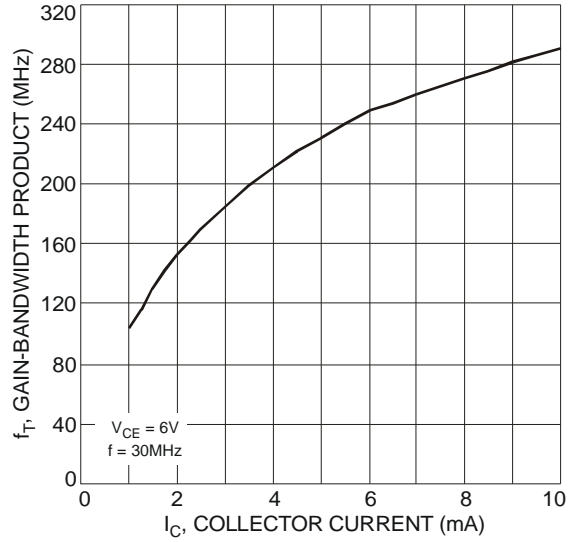
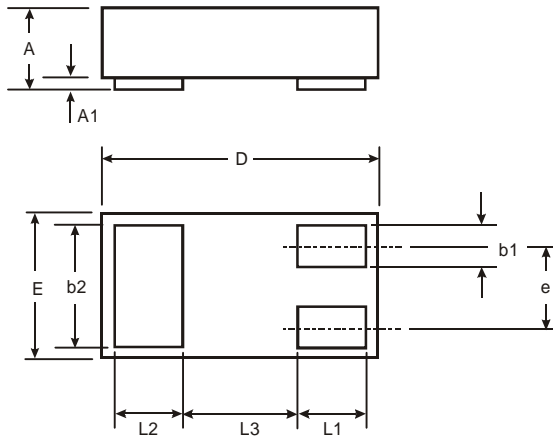

Fig. 8 Typical Gain-Bandwidth Product vs. Collector Current

Package Outline Dimensions



DFN1006H4-3			
Dim	Min	Max	Typ
A	—	0.40	—
A1	0	0.05	0.02
b1	0.10	0.20	0.15
b2	0.45	0.55	0.50
D	0.95	1.075	1.00
E	0.55	0.675	0.60
e	—	—	0.35
L1	0.20	0.30	0.25
L2	0.20	0.30	0.25
L3	—	—	0.40
All Dimensions in mm			

Suggested Pad Layout

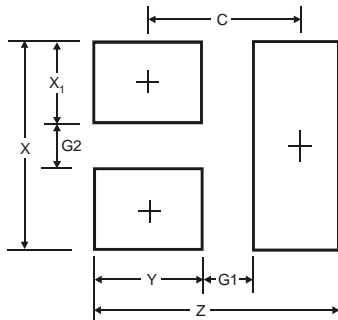

Dimensions	Value (in mm)
Z	1.1
G1	0.3
G2	0.2
X	0.7
X1	0.25
Y	0.4
C	0.7

IMPORTANT NOTICE

DIODES INCORPORATED MAKES NO WARRANTY OF ANY KIND, EXPRESS OR IMPLIED, WITH REGARDS TO THIS DOCUMENT, INCLUDING, BUT NOT LIMITED TO, THE IMPLIED WARRANTIES OF MERCHANTABILITY AND FITNESS FOR A PARTICULAR PURPOSE (AND THEIR EQUIVALENTS UNDER THE LAWS OF ANY JURISDICTION).

Diodes Incorporated and its subsidiaries reserve the right to make modifications, enhancements, improvements, corrections or other changes without further notice to this document and any product described herein. Diodes Incorporated does not assume any liability arising out of the application or use of this document or any product described herein; neither does Diodes Incorporated convey any license under its patent or trademark rights, nor the rights of others. Any Customer or user of this document or products described herein in such applications shall assume all risks of such use and will agree to hold Diodes Incorporated and all the companies whose products are represented on Diodes Incorporated website, harmless against all damages.

Diodes Incorporated does not warrant or accept any liability whatsoever in respect of any products purchased through unauthorized sales channel. Should Customers purchase or use Diodes Incorporated products for any unintended or unauthorized application, Customers shall indemnify and hold Diodes Incorporated and its representatives harmless against all claims, damages, expenses, and attorney fees arising out of, directly or indirectly, any claim of personal injury or death associated with such unintended or unauthorized application.

Products described herein may be covered by one or more United States, international or foreign patents pending. Product names and markings noted herein may also be covered by one or more United States, international or foreign trademarks.

LIFE SUPPORT

Diodes Incorporated products are specifically not authorized for use as critical components in life support devices or systems without the express written approval of the Chief Executive Officer of Diodes Incorporated. As used herein:

A. Life support devices or systems are devices or systems which:

1. are intended to implant into the body, or
2. support or sustain life and whose failure to perform when properly used in accordance with instructions for use provided in the labeling can be reasonably expected to result in significant injury to the user.

B. A critical component is any component in a life support device or system whose failure to perform can be reasonably expected to cause the failure of the life support device or to affect its safety or effectiveness.

Customers represent that they have all necessary expertise in the safety and regulatory ramifications of their life support devices or systems, and acknowledge and agree that they are solely responsible for all legal, regulatory and safety-related requirements concerning their products and any use of Diodes Incorporated products in such safety-critical, life support devices or systems, notwithstanding any devices- or systems-related information or support that may be provided by Diodes Incorporated. Further, Customers must fully indemnify Diodes Incorporated and its representatives against any damages arising out of the use of Diodes Incorporated products in such safety-critical, life support devices or systems.

Copyright © 2011, Diodes Incorporated

www.diodes.com



Стандарт Электрон Связь

Мы молодая и активно развивающаяся компания в области поставок электронных компонентов. Мы поставляем электронные компоненты отечественного и импортного производства напрямую от производителей и с крупнейших складов мира.

Благодаря сотрудничеству с мировыми поставщиками мы осуществляем комплексные и плановые поставки широчайшего спектра электронных компонентов.

Собственная эффективная логистика и склад в обеспечивает надежную поставку продукции в точно указанные сроки по всей России.

Мы осуществляем техническую поддержку нашим клиентам и предпродажную проверку качества продукции. На все поставляемые продукты мы предоставляем гарантию .

Осуществляем поставки продукции под контролем ВП МО РФ на предприятия военно-промышленного комплекса России , а также работаем в рамках 275 ФЗ с открытием отдельных счетов в уполномоченном банке. Система менеджмента качества компании соответствует требованиям ГОСТ ISO 9001.

Минимальные сроки поставки, гибкие цены, неограниченный ассортимент и индивидуальный подход к клиентам являются основой для выстраивания долгосрочного и эффективного сотрудничества с предприятиями радиоэлектронной промышленности, предприятиями ВПК и научно-исследовательскими институтами России.

С нами вы становитесь еще успешнее!

Наши контакты:

Телефон: +7 812 627 14 35

Электронная почта: sales@st-electron.ru

Адрес: 198099, Санкт-Петербург,
Промышленная ул, дом № 19, литера Н,
помещение 100-Н Офис 331