

User Guide

MPX2001 Evaluation Kit (EVKT-MPX2001-45-PD)

Table of Contents

Overview.....	2
Introduction.....	2
Kit Contents	2
Features and Benefits.....	3
Kit Specifications.....	3
Section 1. Hardware Specifications	4
1.1 Personal Computer Requirements	4
1.2 EVKT-MPX2001-45-PD Specifications	4
1.3 EVKT-MPX2001-45-PD Specifications	4
Section 2. Software Requirements	5
2.1 Software Installation Procedure	5
Section 3. Evaluation Kit Test Set-up.....	8
3.1 Hardware Setup.....	8
3.2 Powering up the EVB	8
3.3 Software Set-Up	8
3.4 Troubleshooting Tips	10
Section 4. Evaluation Demo Board Information.....	11
4.1 Evaluation Demo Board Schematic	11
4.2 Evaluation Demo Board PCB Layout.....	12
4.3 Evaluation Demo Board Bill of Material	12
Section 5. Ordering Information.....	14

Overview

Introduction

The EVKT-MPX2001-45-PD is an evaluation kit for the MPX2001. The evaluation board is designed for a 45W Type-C PD adapter. The board is designed in a very small form factor with a very high power density. Its electrical specifications are suitable for the typical cell phone and computer power adapter. The particular benefits for the board are the very low no-load power consumption (<0.075W) and the very high overall efficiency, meets DOE Level VI & CoC Tier2. With the USBCEE USB-C Power Adapter Tester (PAT), the performance of the board can be easily evaluated.

Kit Contents

EVKT-MPX2001-45-PD kit contents (items below can be ordered separately).

#	Part Number	Item	Quantity
1	EVX2001-Y-02A	MPX2001 evaluation board	1
2	USB Power Adapter Tester (PAT)	Including the PAT hardware and PAT utility	1
3	Micro USB Cable and Type-C Cable	Connect the PC and PAT with the evaluation board	2

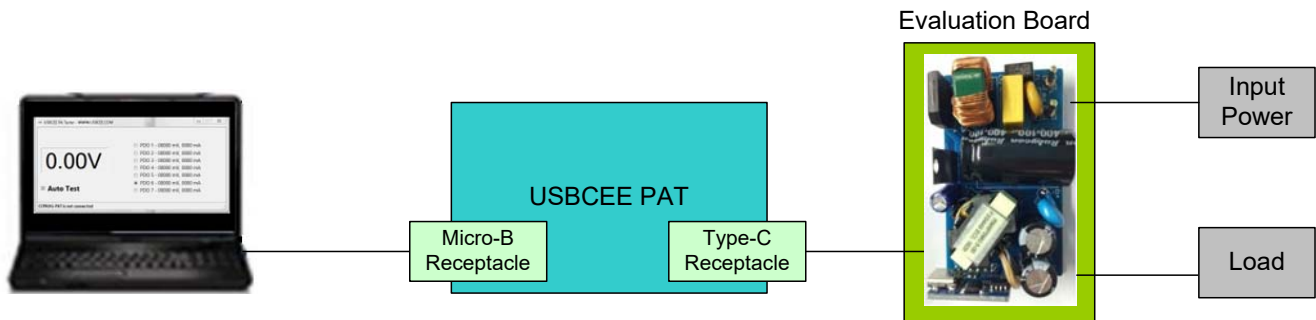

Figure 1: EVKT-MPX2001-45-PD Evaluation Kit Set-Up

Features and Benefits

The evaluation board is mainly designed to demonstrate the capabilities of MPS highly integrated controller MPX2001. The MPX2001 is an all-in-one flyback controller aims at high-performance and high-integration solution. It integrates the primary side driver, secondary side controller and synchronous rectifier (SR) driver in one chip. So the opto-coupler and TL431 can be saved from the secondary side and SR can be turned off on time without any shoot through risk.

⚠ The evaluation board works under high voltage circumstance, do not touch it.

Kit Specifications

Features	Specification
Operating Input Voltage	90Vac -265Vac
Operating Output Voltage	5V/9V/15V/20V
Operating Output Current	3A/3A/3A/2.25A
Operating Systems Supported	Windows XP, 7, and later
System Requirements	Minimum 50 MB free
Utility Software	USBCEE PAT Utility and Cypress' EZ-PD™ Configuration Utility
EVB Size (L x W)	6.85 cm x 3.92 cm

Section 1. Hardware Specifications

1.1 Personal Computer Requirements

The following must be minimally met to use the EVKT-MPX2001-45-PD.

- Operating System of Windows XP, 7 or later
- PC with a minimum of one available USB port
- At least 50 MB of free space

1.2 EVKT-MPX2001-45-PD Specifications

The EVX2001-Y-02A is an evaluation board for the MPX2001. For more information, please refer to the Section 4.



Figure 2: EVX2001-Y-02A Evaluation Board

Feature	Specification
Operating Input Voltage	90V - 265V
Operating Input Voltage	5V/9V/15V/20V
EVB Size (L X W)	6.85cm X 3.92cm

1.3 EVKT-MPX2001-45-PD Specifications

EVKT-MPX2001-45-PD USBCEE Power Adapter Tester (PAT) is used to

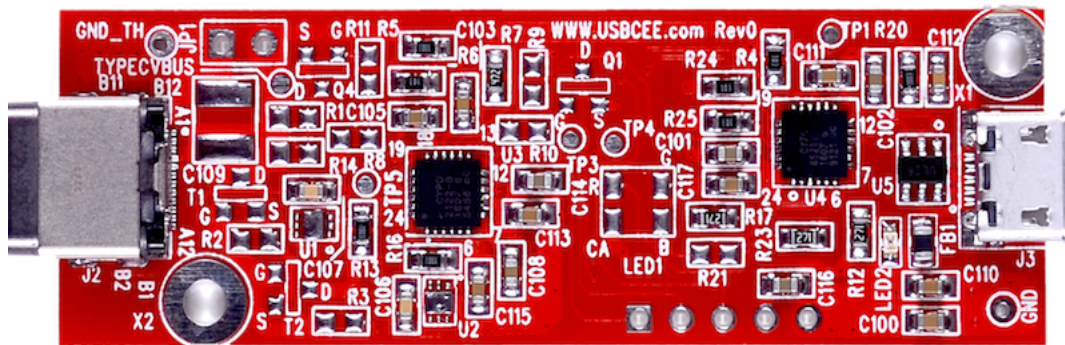

Figure 3: EVKT-MPX2001-45-PD USBCEE PAT

Section 2. Software Requirements

2.1 Software Installation Procedure

The evaluation board should cooperate with the USBCEE PAT. Follow the instructions below to install the software.

1. Plug the thumb drive into the computer using any available USB port.
2. Double click the icon of EZ-PD Configuration Utility Setup.
3. The application needs Microsoft.NET Framework 3.5, please install the .NET framework 3.5 then relaunch this application (see Figure 4)
4. Follow the steps to install the software (see Figure 5).
5. Fill in the contact information to complete the installation (see Figure 6).

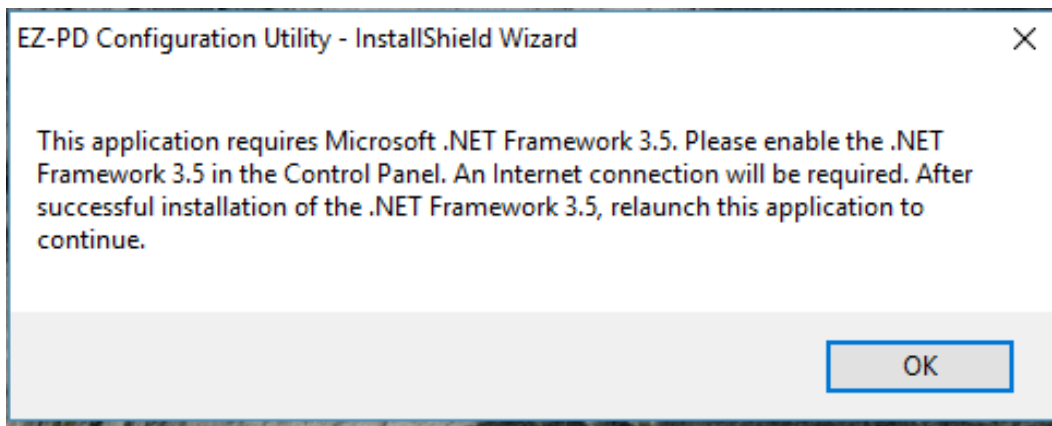
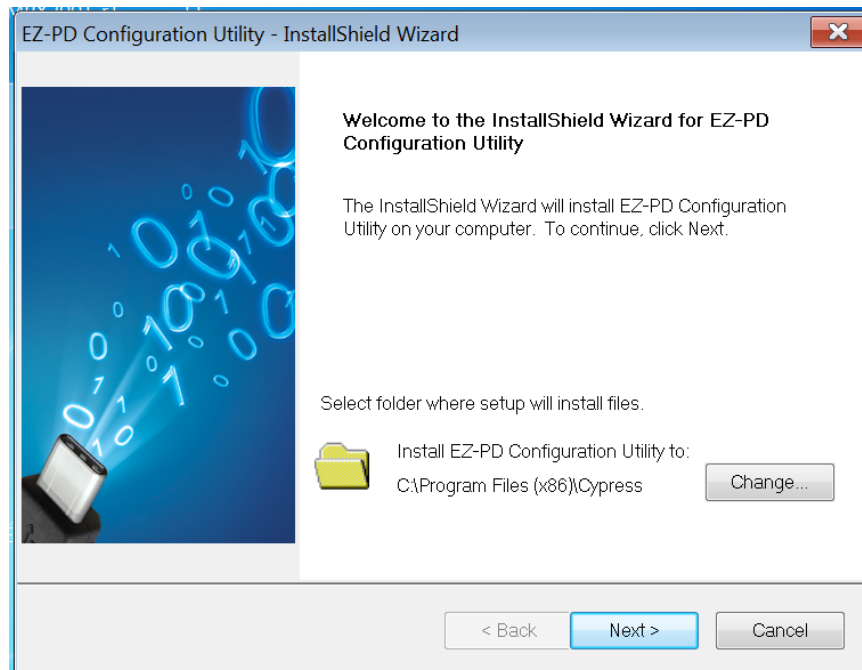
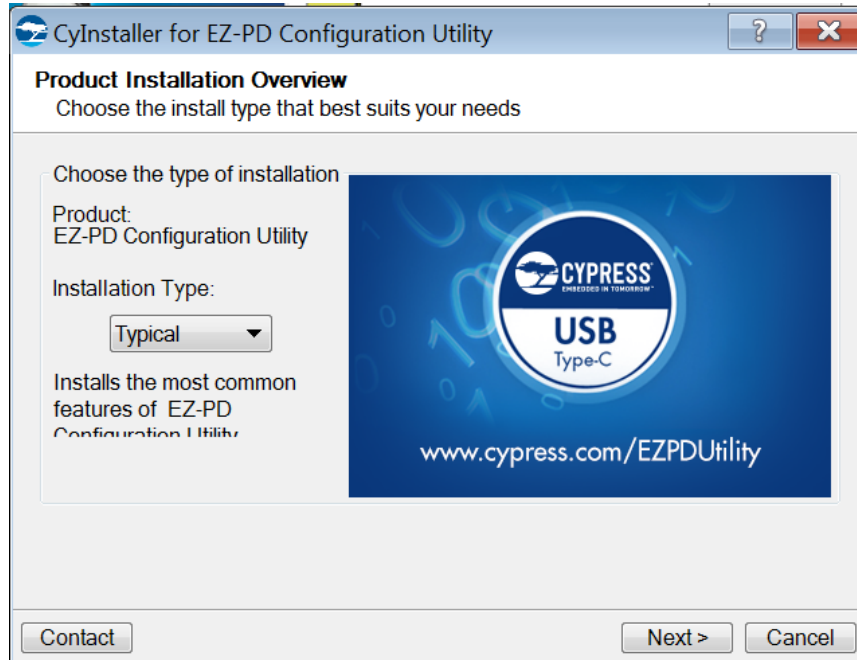

Figure 4: Microsoft .NET Framework 3.5 Requirement



(5-a)



(5-b)

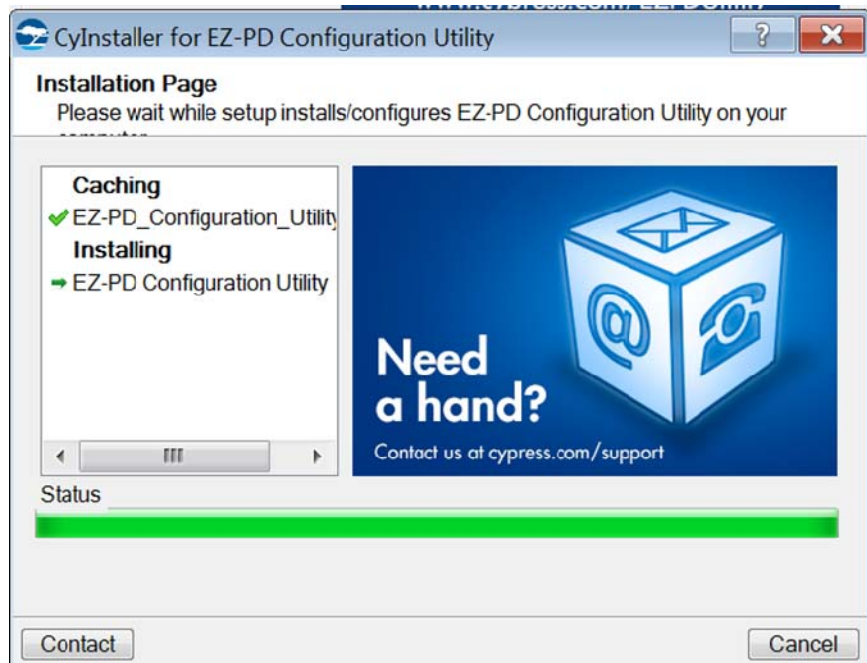

(5-c)

Figure 5: USBCEE PAT Utility Installation Steps

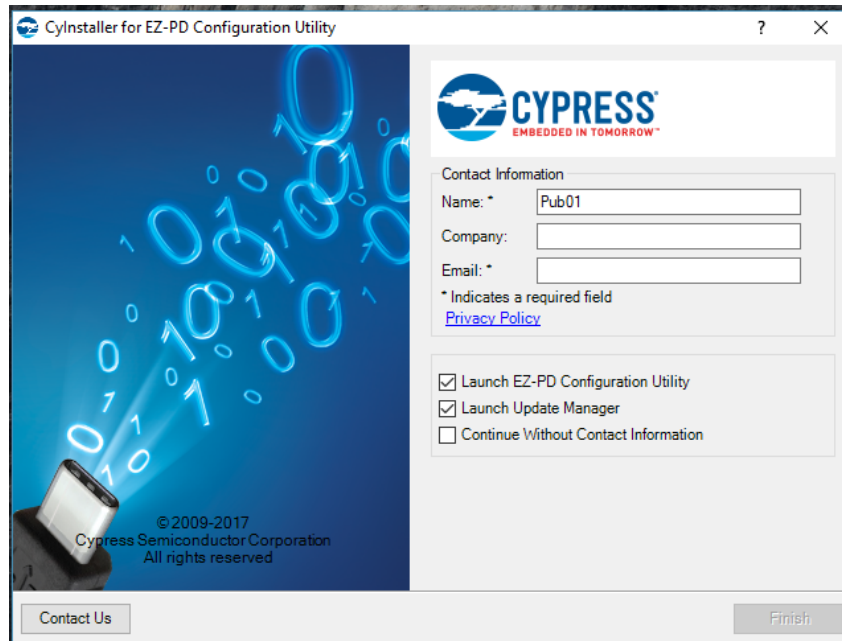

Figure 6: Contact Information to Finish Installation

Section 3. Evaluation Kit Test Set-up

3.1 Hardware Setup

The hardware must be properly configured prior to use. Follow the instructions below to set up the EVB.

1. Connect the USBCEE PAT hardware with host PC through the Mirco USB cable.
2. Connect the USBCEE PAT hardware with MPX2001 evaluation board through the Type-C cable.
3. Connect the AC input with MPX2001 evaluation board.
4. Connect the output terminal with the electronic load.



Figure 7: EVKT-MPX2001-45-PD Hardware Setup

3.2 Powering up the EVB

1. Turn the AC input power supply on.

3.3 Software Set-Up

After connecting the hardware according to Section 3.1, follow the steps below to use the GUI software.

1. Start the software. It will automatically check the USBCEE PAT hardware connection. The connection status is shown in the lower-left corner.

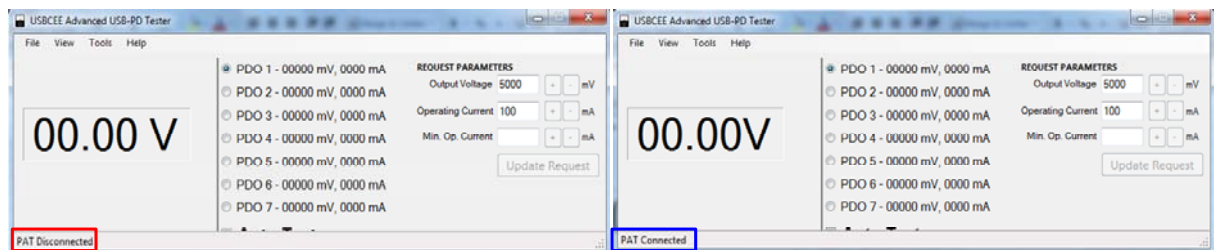

Figure 8: Software Initial Interface

If the connection is OK, the software shows the PAT connected and the PAT hardware power LED lights. Otherwise, please check if the hardware connection is right.

- Turn on the input power, then the status is shown as the USB-PD contract established in the lower-left corner and also the output voltage is captured. The output voltage can be modulated by manual or automatic.

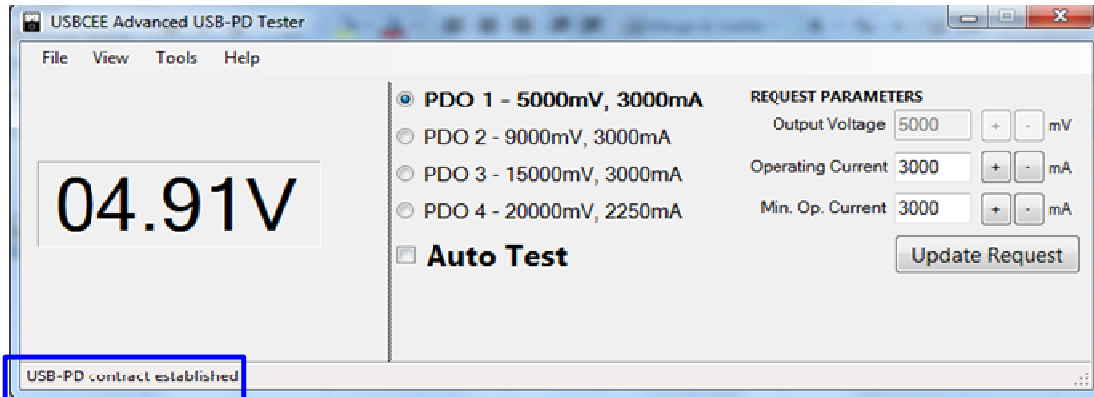

Figure 9: Software Interface after AC Supply Turns On

- Adjust the output manually, click the each PDO channel, then the output changes accordingly.

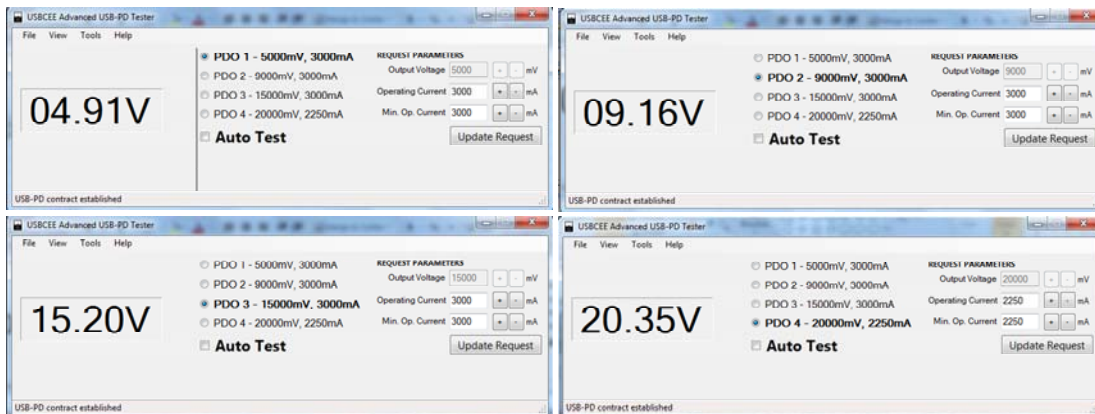

Figure 10: Manually Change Output Voltage

- The evaluation board voltage can also be changed by auto test. Click the Auto Test and the output voltage changes from 5V to 9V, 9V to 15V, then keeps 20V finally.

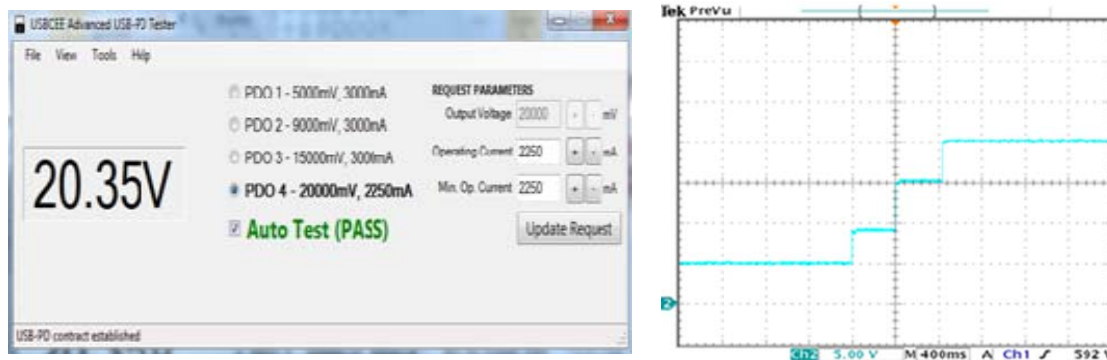

Figure 11: Auto Test by PAT Utility

3.4 Troubleshooting Tips

- **Software Installation Failure**

1. No Microsoft .NET Framework 3.5 installed, please take Figure 4 for reference.
2. No contact information is filled in, please take Figure 6 for reference.

- **No Output**

1. Check if hardware connection is correct.
2. Check if AC power supply is ready.
3. Check if the load current is higher than the output current limit by USBCEE PAT.
4. Check if the electronic load influences the normal operation of USBCEE PAT.

Section 4. Evaluation Demo Board Information

4.1 Evaluation Demo Board Schematic

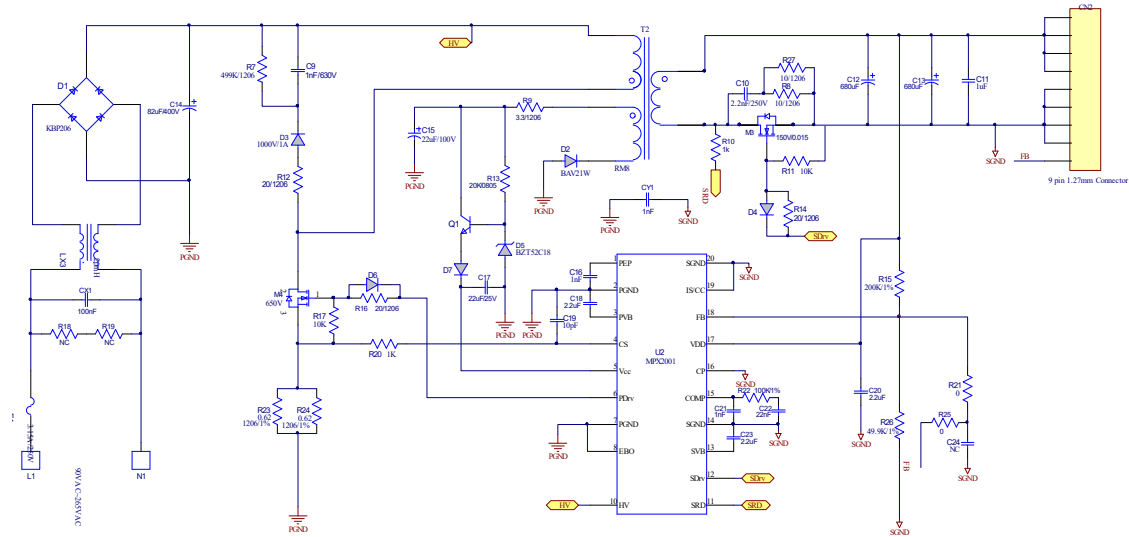

Figure 12: Main Power Board Schematic

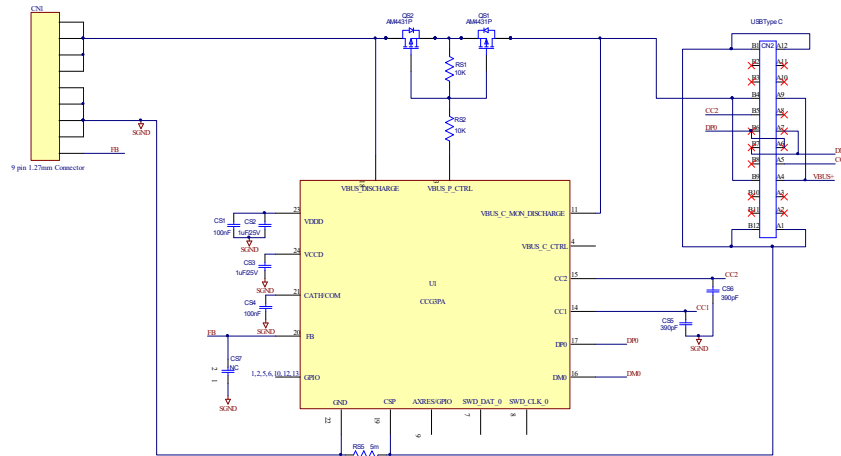

Figure 13: Daughter Board Schematic

4.2 Evaluation Demo Board PCB Layout

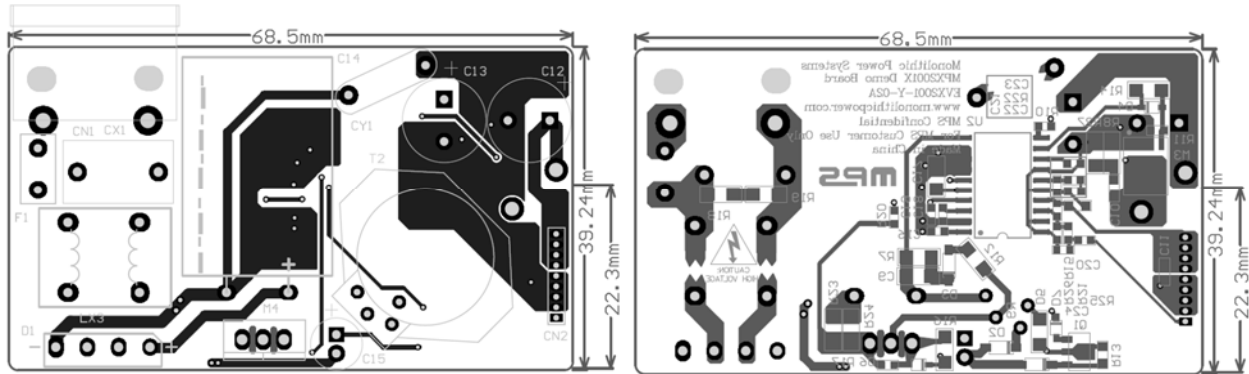

Figure 14: Top and Bottom Layer of Main Board

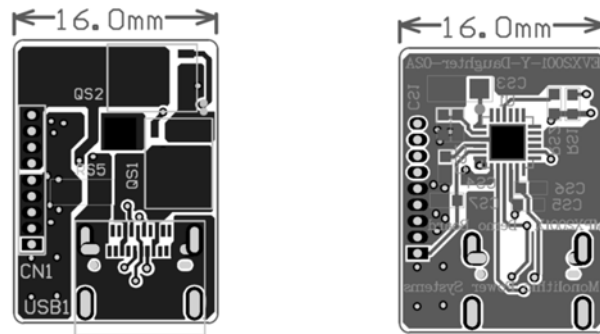

Figure 15: Top and Bottom Layer of Daughter Board

4.3 Evaluation Demo Board Bill of Material

Item	Qty	RefDes	Value	Description	Package	Manufacturer	Manufacturer_P/N
1	1	C9	1nF/630V	Ceramic Capacitor;630V;U2J	1206	Murata	GRM31A7U2J102JW31D
2	1	C10	2.2nF	Ceramic Capacitor;250V;X7R;	0805	TDK	C2012X7R2E222K
3	1	C11	1uF	Ceramic Capacitor;25V;X7R;0805;	0805	TDK	C2012X7R1E105K
4	2	C12, C13	680uF	Electrolytic Capacitor;25V;DIP	DIP	Rubycon	25ZLH680MEFC10*16
5	1	C14	82uF	Electrolytic Capacitor;400V;18*25	DIP	Any	
6	1	C15	22uF/100V	Electrolytic Capacitor;100V;DIP	DIP	Aihua	ERJ1KM220E120T
7	2	C16,C21	1nF	Ceramic Capacitor;25V;C0G;0603;	0603	muRata	GRM1885C1E102JA01D
8	1	C17	22uF	Ceramic Capacitor;25V;X7R;1206	1206	TDK	C3216X5R1E226MT
9	2	C18, C23	2.2uF	Ceramic Capacitor;10V;X7R;0603;	0603	muRata	GRM188R71A225KE15D
10	1	C19	10pF	Ceramic Capacitor;50V;C0G;0603;	0603	muRata	GRM1885C1H100JA01
11	1	C20	2.2uF	Ceramic Capacitor;25V;C0G;0805;	0805	muRata	GRM21BR71E225KA73L
12	1	C22	22nF	Ceramic Capacitor;50V;X7R;0603;	0603	muRata	GRM188R71H223KA01D
13	0	C24	NC	No Connected	0603		
14	1	CX1	100nF	Capacitor;275V;10%	DIP	Carli	PX104K3IC39L270D9R

15	1	CY1	2.2nF	Y Cap,250V	DIP	Hongke	JNK12E22ML02N
16	1	D1	KBP206	Diode;600V;2A	DIP	Diode	KBP206
17	1	D2	BAV21W	Diode;200V;0.2A;	SOD-123	Diodes	BAV21W-7-F
18	1	D3	S1ML	Diode;1000V;1A	SOD-123	Taiwan Semi	S1ML
19	3	D4, D6, D7	1N4148WS	Diode;75V;0.15A;	SOD-323	Diodes	1N4148WS-7-F
20	1	D5	BZT52C18	Zener Diode;18V;5mA;	SOD-123	Diodes	BZT52C18
21	1	F1	SS-5-3.15A	Fuse;250V;3.15A	DIP	COOPER BUSSMANN	SS-5-3.15A
22	1	LX3	20mH	Common Choke;20mH;2A	DIP	Dekelong	T16*12*8
23	1	Q1	2SC3648	Transistor;0.7A;	SOT-89	Sanyo	2SC3648
24	1	M3	150V,0.015Ohm	N Channel Mosfet, 150V/0.015Ohm	Powerpak SO8	Fairchild	FDMS86200
25	1	M4	650V,0.38Ohm	N Channel Mosfet, 650V/0.38Ohm	TO220	Infineon	IP165R380C6
26	1	R7	499K/1206	Film Resistor;1%;	1206	Yageo	RC1206FR-07499KL
27	2	R8,R27	10/1206	Film Resistor;5%;1/4	1206	Yageo	RC1206JR-0710RL
28	1	R9	3.3/1206	Film Resistor;1%;1/4W;	1206	Yageo	RC1206FR-073R3L
29	2	R10,R20	1K	Resistor;1%;1/16W;	0603	Ralec	RF0603-1K
30	2	R11,R17	10K	Film Resistor;1%;	0603	Yageo	RC0603FR-0710KL
31	3	R12,R14,R16	20	Resistor;5%;1/16W;	1206	Yageo	RC1206JR-0720RL
32	1	R13	20K/1%	Film Resistor;1%;1/10W;	0805	Yageo	RC0805JR-0720KL
33	1	R15	200K/1%	Film Resistor;1%;	0603	Yageo	RC0603FR-07200KL
34	0	R18,R19	NC	No Connected	1206		
35	2	R21,R25	0/5%	Film Resistor;1%;1/10W;	0603	Yageo	RC0603JR-070RL
36	1	R22	100K/1%	Film Resistor;1%;1/10W;	0603	Yageo	RC0603FR-07100KL
37	2	R23,R24	0.62/1206/1%	Film Resistor;1%;1/4W;	1206	Yageo	RC1206FR-070R62L
38	1	R26	49.9K/1%	Film Resistor;1%;1/10W;	0603	Yageo	RC0603FR-0749K9L
39	1	T2		Transformer, 0.51mH,	RM8	Emei	FX0509
40	1	U2	MPX2001	All-in-one Controller		MPS	All In One
41	1	CN1		AC Input Connector			
42	1	CN2		1.27mm 90° Header			
BOM of Daughter Board							
43	2	CS1,CS4	100nF	Ceramic Capacitor;25V;X7R;0603	0603	muRata	GRM188R71E104KA01D
44	1	CS2	1uF	Ceramic Capacitor;25V;X7R;0603	0603	muRata	GRM188R71E105KA12D
45	1	CS3	1uF	Ceramic Capacitor;25V;X7R;1206	1206	muRata	GRM31MR71E105KA01
46	2	CS5,CS6	390pF	Ceramic Capacitor;50V;C0G;0603;	0603	muRata	GRM033R71H391KA12D
47	1	CS7	NC				
48	2	C6,C7	1uF	Ceramic Capacitor;10V;X7R	0603	Murata	GRM188R71A105KA61D
49	1	CN1		9 Pin/1.27mm			
50	1	USB1		Type C USB Connector			
51	2	QS1,QS2	AM4431P	P Channel Mosfet, -30V/7mOhm	SOP-8	Analog Power	AM4431P
52	2	RS1,RS2	10K	Film Resistor;1%;	0603	Yageo	RC0603FR-0710KL
53	1	RS5	5mΩ	Film Resistor;1%;1/4	1206	Yageo	RC1206FR-070R005L
54	1	U1		USB PD Controller	QFN24	Cypress	CYPD3175-24LQXQ

Section 5. Ordering Information

The components of the evaluation kit can be purchased separately depending on user needs.

Part Number	Description
-------------	-------------

EVKT-MPX2001-45-PD	Complete evaluation kit
--------------------	-------------------------

Contents of EVKT-MPX2001-45-PD

EVX2001-Y-02A	MPX2001 45W evaluation board for USB PD
---------------	---

USBCEE PAT Hardware and Utility	Including one USBCEE PAT hardware, the GUI of the hardware, one Mirco USB cable and one Type-C cable
---------------------------------	--

Order directly from MonolithicPower.com or our distributors.



Стандарт Электрон Связь

Мы молодая и активно развивающаяся компания в области поставок электронных компонентов. Мы поставляем электронные компоненты отечественного и импортного производства напрямую от производителей и с крупнейших складов мира.

Благодаря сотрудничеству с мировыми поставщиками мы осуществляем комплексные и плановые поставки широчайшего спектра электронных компонентов.

Собственная эффективная логистика и склад в обеспечивает надежную поставку продукции в точно указанные сроки по всей России.

Мы осуществляем техническую поддержку нашим клиентам и предпродажную проверку качества продукции. На все поставляемые продукты мы предоставляем гарантию .

Осуществляем поставки продукции под контролем ВП МО РФ на предприятия военно-промышленного комплекса России , а также работаем в рамках 275 ФЗ с открытием отдельных счетов в уполномоченном банке. Система менеджмента качества компании соответствует требованиям ГОСТ ISO 9001.

Минимальные сроки поставки, гибкие цены, неограниченный ассортимент и индивидуальный подход к клиентам являются основой для выстраивания долгосрочного и эффективного сотрудничества с предприятиями радиоэлектронной промышленности, предприятиями ВПК и научно-исследовательскими институтами России.

С нами вы становитесь еще успешнее!

Наши контакты:

Телефон: +7 812 627 14 35

Электронная почта: sales@st-electron.ru

Адрес: 198099, Санкт-Петербург,
Промышленная ул, дом № 19, литера Н,
помещение 100-Н Офис 331