

N-channel 600 V, 0.72 Ω typ., 5.5 A MDmesh II Plus™ low Q_g Power MOSFETs in TO-220FP and I²PAKFP packages

Datasheet - production data

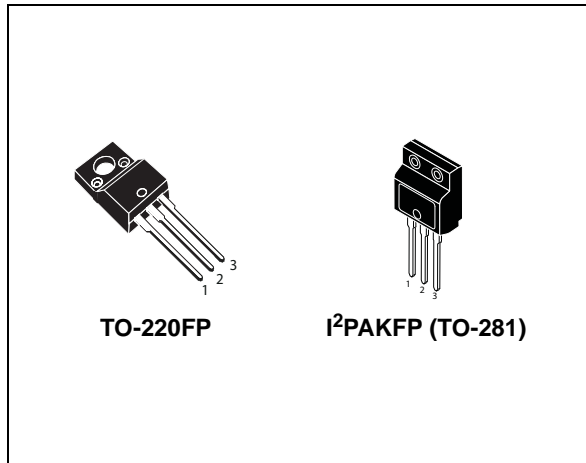
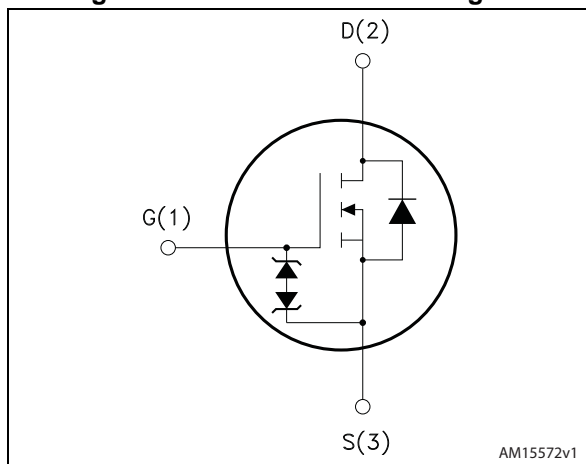

Figure 1. Internal schematic diagram



Features

Order codes	$V_{DS} @ T_{Jmax}$	$R_{DS(on) max}$	I_D
STF9N60M2	650 V	0.78 Ω	5.5 A
STFI9N60M2			

- Extremely low gate charge
- Lower $R_{DS(on)}$ x area vs previous generation
- Low gate input resistance
- 100% avalanche tested
- Zener-protected

Applications

- Switching applications

Description

These devices are N-channel Power MOSFETs developed using a new generation of MDmesh™ technology: MDmesh II Plus™ low Q_g . These revolutionary Power MOSFETs associate a vertical structure to the company's strip layout to yield one of the world's lowest on-resistance and gate charge. They are therefore suitable for the most demanding high efficiency converters.

Table 1. Device summary

Order codes	Marking	Package	Packaging
STF9N60M2	9N60M2	TO-220FP	Tube
STFI9N60M2		I ² PAKFP	

Contents

1	Electrical ratings	3
2	Electrical characteristics	4
	2.1 Electrical characteristics (curves)	6
3	Test circuits	8
4	Package mechanical data	9
5	Revision history	12

1 Electrical ratings

Table 2. Absolute maximum ratings

Symbol	Parameter	Value	Unit
V_{GS}	Gate-source voltage	± 25	V
I_D	Drain current (continuous) at $T_C = 25\text{ °C}$	5.5 ⁽¹⁾	A
I_D	Drain current (continuous) at $T_C = 100\text{ °C}$	3.6 ⁽¹⁾	A
$I_{DM}^{(1)}$	Drain current (pulsed)	22 ⁽¹⁾	A
P_{TOT}	Total dissipation at $T_C = 25\text{ °C}$	20	W
V_{ISO}	Insulation withstand voltage (RMS) from all three leads to external heat sink ($t=1\text{ s}$; $T_C=25\text{ °C}$)	2500	V
$dv/dt^{(2)}$	Peak diode recovery voltage slope	15	V/ns
$dv/dt^{(3)}$	MOSFET dv/dt ruggedness	50	
T_{stg}	Storage temperature	- 55 to 150	°C
T_j	Max. operating junction temperature	150	

1. Pulse width limited by safe operating area.
2. $I_{SD} \leq 5.5\text{ A}$, $di/dt \leq 400\text{ A}/\mu\text{s}$; $V_{DS\text{ peak}} < V_{(BR)DSS}$, $V_{DD}=400\text{ V}$
3. $V_{DS} \leq 480\text{ V}$

Table 3. Thermal data

Symbol	Parameter	Value	Unit
$R_{thj-case}$	Thermal resistance junction-case max	6.25	°C/W
$R_{thj-amb}$	Thermal resistance junction-ambient max	62.5	°C/W

Table 4. Avalanche characteristics

Symbol	Parameter	Value	Unit
I_{AR}	Avalanche current, repetitive or not repetitive (pulse width limited by T_{jmax})	2	A
E_{AS}	Single pulse avalanche energy (starting $T_j=25\text{ °C}$, $I_D=I_{AR}$; $V_{DD}=50$)	105	mJ

2 Electrical characteristics

($T_C = 25\text{ °C}$ unless otherwise specified)

Table 5. On /off states

Symbol	Parameter	Test conditions	Min.	Typ.	Max.	Unit
$V_{(BR)DSS}$	Drain-source breakdown voltage	$I_D = 1\text{ mA}$, $V_{GS} = 0$	600			V
I_{DSS}	Zero gate voltage drain current ($V_{GS} = 0$)	$V_{DS} = 600\text{ V}$			1	μA
		$V_{DS} = 600\text{ V}$, $T_C = 125\text{ °C}$			100	μA
I_{GSS}	Gate-body leakage current ($V_{DS} = 0$)	$V_{GS} = \pm 25\text{ V}$			± 10	μA
$V_{GS(th)}$	Gate threshold voltage	$V_{DS} = V_{GS}$, $I_D = 250\text{ }\mu\text{A}$	2	3	4	V
$R_{DS(on)}$	Static drain-source on-resistance	$V_{GS} = 10\text{ V}$, $I_D = 3\text{ A}$		0.72	0.78	Ω

Table 6. Dynamic

Symbol	Parameter	Test conditions	Min.	Typ.	Max.	Unit
C_{iss}	Input capacitance	$V_{DS} = 100\text{ V}$, $f = 1\text{ MHz}$, $V_{GS} = 0$	-	320	-	pF
C_{oss}	Output capacitance		-	18	-	pF
C_{rss}	Reverse transfer capacitance		-	0.68	-	pF
$C_{oss\text{ eq.}}^{(1)}$	Equivalent output capacitance	$V_{DS} = 0\text{ to }480\text{ V}$, $V_{GS} = 0$	-	88	-	pF
R_G	Intrinsic gate resistance	$f = 1\text{ MHz}$ open drain	-	6.5	-	Ω
Q_g	Total gate charge	$V_{DD} = 480\text{ V}$, $I_D = 5.5\text{ A}$, $V_{GS} = 10\text{ V}$ (see Figure 15)	-	10	-	nC
Q_{gs}	Gate-source charge		-	2	-	nC
Q_{gd}	Gate-drain charge		-	5.1	-	nC

1. $C_{oss\text{ eq.}}$ is defined as a constant equivalent capacitance giving the same charging time as C_{oss} when V_{DS} increases from 0 to 80% V_{DSS}

Table 7. Switching times

Symbol	Parameter	Test conditions	Min.	Typ.	Max.	Unit
$t_{d(on)}$	Turn-on delay time	$V_{DD} = 300\text{ V}$, $I_D = 3\text{ A}$, $R_G = 4.7\text{ }\Omega$, $V_{GS} = 10\text{ V}$ (see Figure 14 and Figure 19)	-	8.8	-	ns
t_r	Rise time		-	7.5	-	ns
$t_{d(off)}$	Turn-off delay time		-	22	-	ns
t_f	Fall time		-	13.5	-	ns

Table 8. Source drain diode

Symbol	Parameter	Test conditions	Min.	Typ.	Max.	Unit
I_{SD}	Source-drain current		-		5.5	A
$I_{SDM}^{(1)}$	Source-drain current (pulsed)		-		22	A
$V_{SD}^{(2)}$	Forward on voltage	$I_{SD} = 5.5 \text{ A}$, $V_{GS} = 0$	-		1.6	V
t_{rr}	Reverse recovery time	$I_{SD} = 5.5 \text{ A}$, $di/dt = 100 \text{ A}/\mu\text{s}$ $V_{DD} = 60 \text{ V}$ (see Figure 16)	-	265		ns
Q_{rr}	Reverse recovery charge		-	1.65		μC
I_{RRM}	Reverse recovery current		-	12.5		A
t_{rr}	Reverse recovery time	$I_{SD} = 5.5 \text{ A}$, $di/dt = 100 \text{ A}/\mu\text{s}$ $V_{DD} = 60 \text{ V}$, $T_j = 150 \text{ }^\circ\text{C}$ (see Figure 16)	-	377		ns
Q_{rr}	Reverse recovery charge		-	2.3		μC
I_{RRM}	Reverse recovery current		-	12.2		A

1. Pulse width limited by safe operating area.
2. Pulsed: pulse duration = 300 μs , duty cycle 1.5%

2.1 Electrical characteristics (curves)

Figure 2. Safe operating area

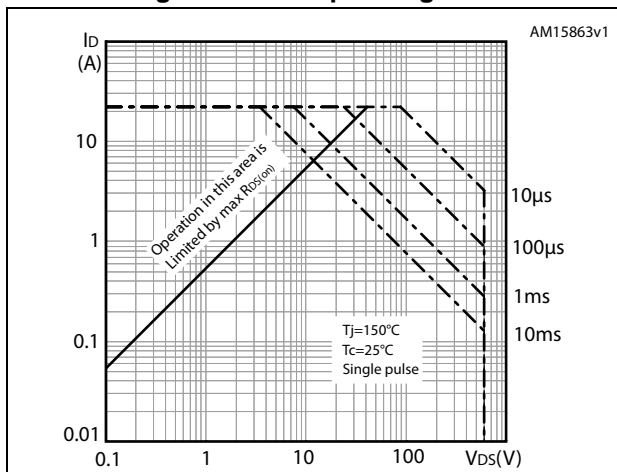

Figure 3. Thermal impedance

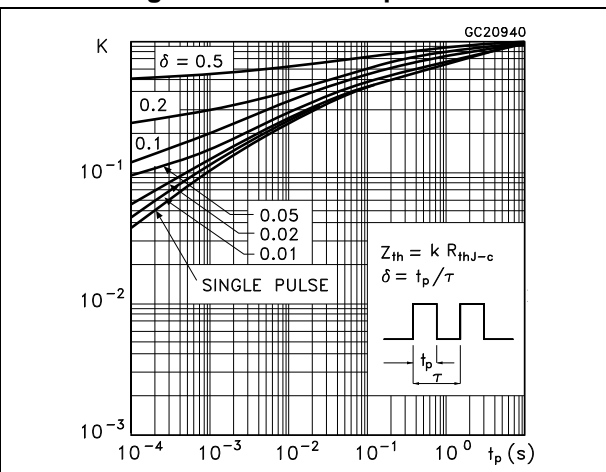

Figure 4. Output characteristics

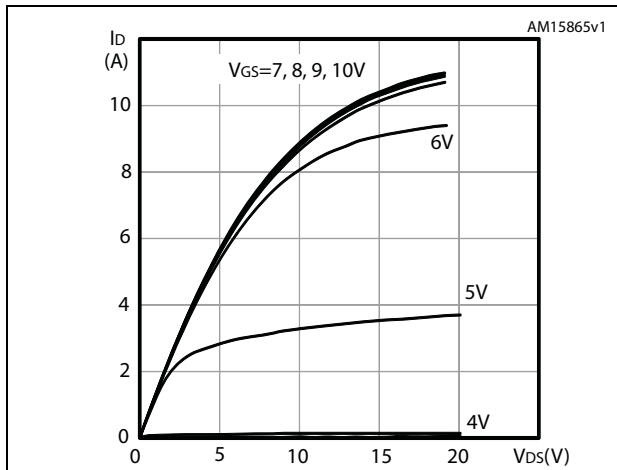

Figure 5. Transfer characteristics

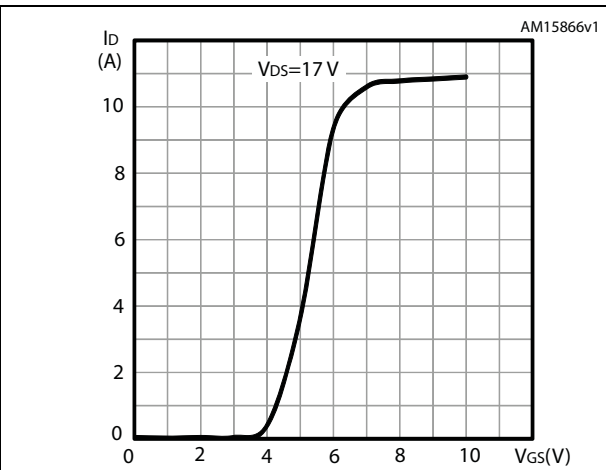

Figure 6. Gate charge vs gate-source voltage

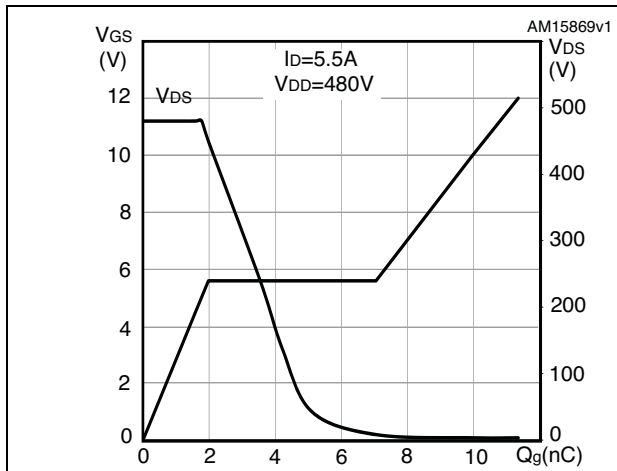

Figure 7. Static drain-source on-resistance

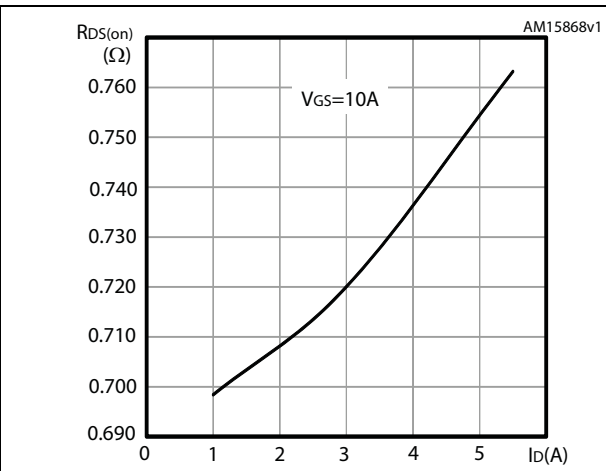

Figure 8. Capacitance variations

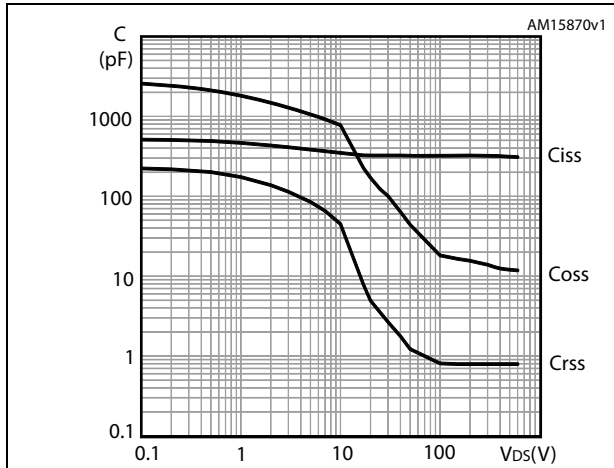

Figure 9. Output capacitance stored energy

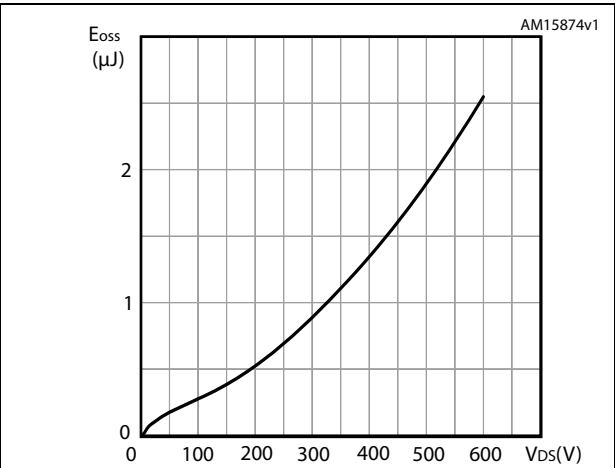

Figure 10. Normalized gate threshold voltage vs temperature

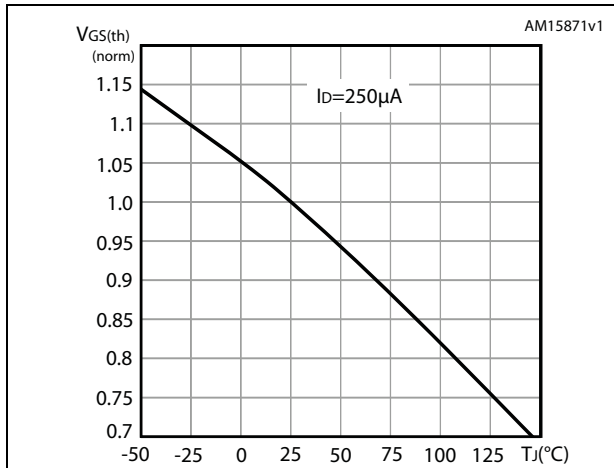

Figure 11. Normalized on-resistance vs temperature

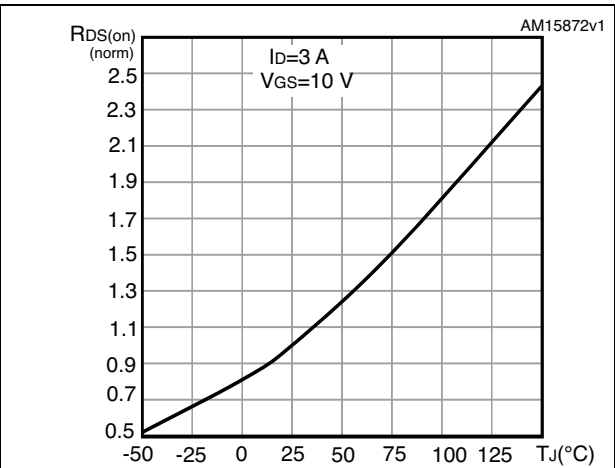

Figure 12. Source-drain diode forward characteristics

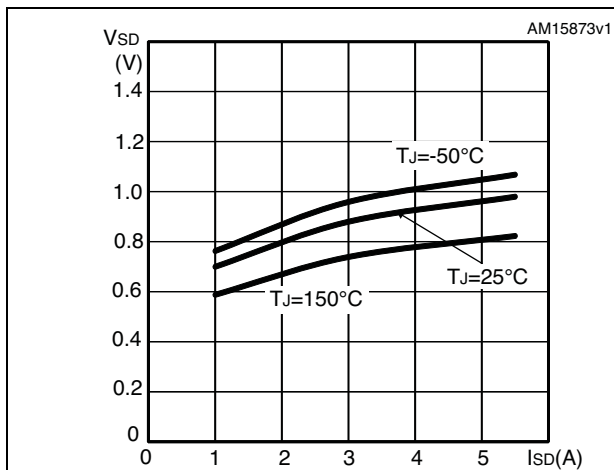
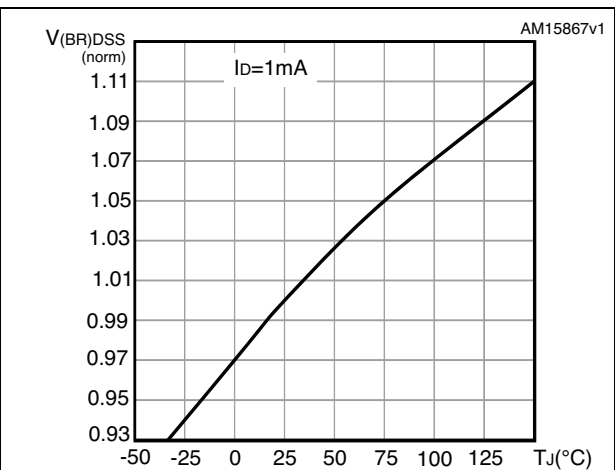

Figure 13. Normalized V(BR)DSS vs temperature



3 Test circuits

Figure 14. Switching times test circuit for resistive load



Figure 15. Gate charge test circuit



Figure 16. Test circuit for inductive load switching and diode recovery times



Figure 17. Unclamped inductive load test circuit



Figure 18. Unclamped inductive waveform

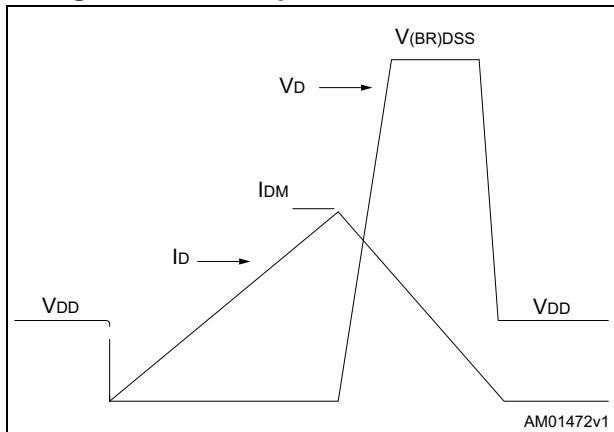

Figure 19. Switching time waveform



4 Package mechanical data

In order to meet environmental requirements, ST offers these devices in different grades of ECOPACK[®] packages, depending on their level of environmental compliance. ECOPACK[®] specifications, grade definitions and product status are available at: www.st.com. ECOPACK[®] is an ST trademark.

4.1 TO-220FP, STF9N60M2

Figure 20. TO-220FP drawing

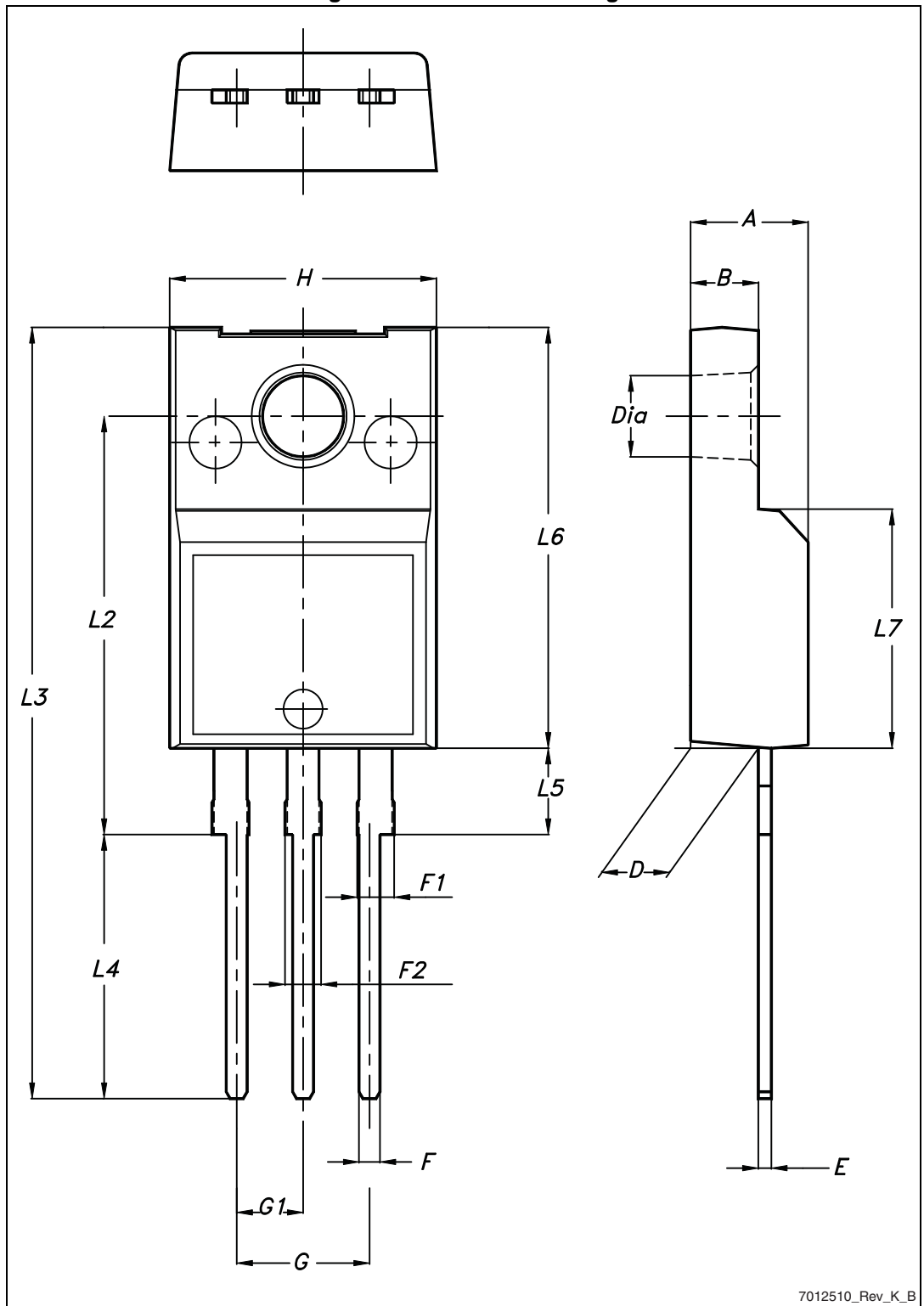

7012510_Rev_K_B

Table 9. TO-220FP mechanical data

Dim.	mm		
	Min.	Typ.	Max.
A	4.4		4.6
B	2.5		2.7
D	2.5		2.75
E	0.45		0.7
F	0.75		1
F1	1.15		1.70
F2	1.15		1.70
G	4.95		5.2
G1	2.4		2.7
H	10		10.4
L2		16	
L3	28.6		30.6
L4	9.8		10.6
L5	2.9		3.6
L6	15.9		16.4
L7	9		9.3
Dia	3		3.2

4.2 I²PAKFP (TO-281), STF19N60M2

Figure 21. I²PAKFP (TO-281) drawing

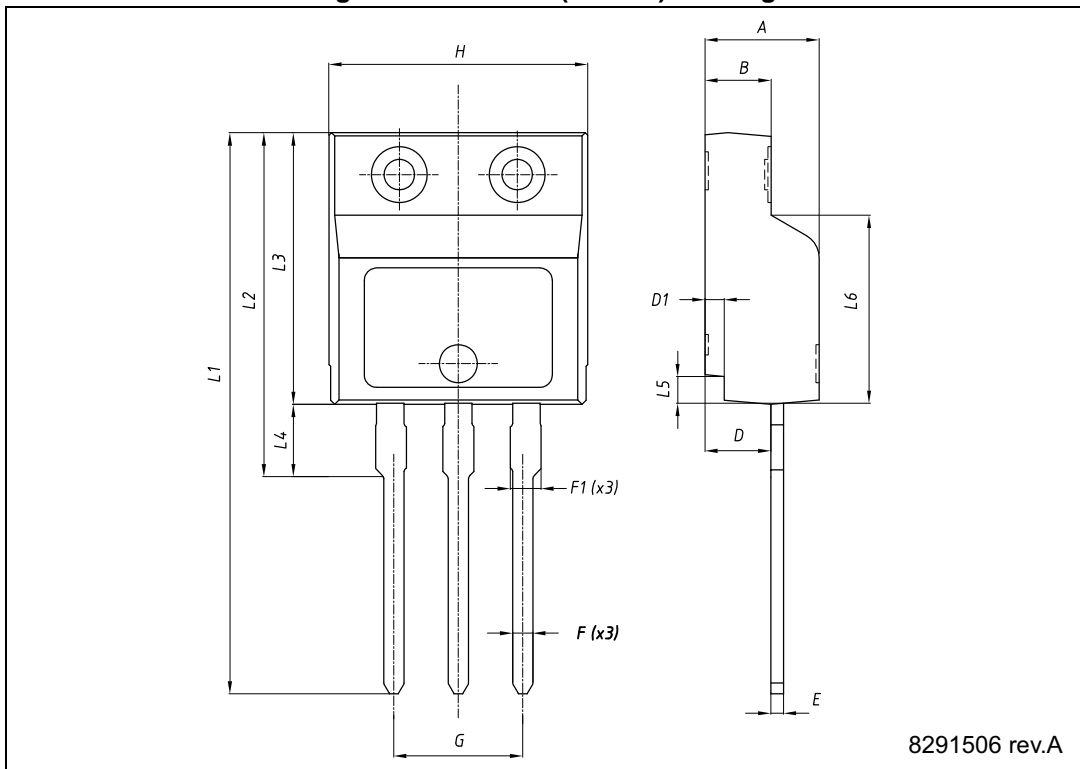

Table 10. I²PAKFP (TO-281) mechanical data

Dim.	mm		
	Min.	Typ.	Max.
A	4.40	-	4.60
B	2.50		2.70
D	2.50		2.75
D1	0.65		0.85
E	0.45		0.70
F	0.75		1.00
F1			1.20
G	4.95		5.20
H	10.00		10.40
L1	21.00		23.00
L2	13.20		14.10
L3	10.55		10.85
L4	2.70		3.20
L5	0.85		1.25
L6	7.30		7.50

5 Revision history

Table 11. Document revision history

Date	Revision	Changes
03-Jun-2013	1	First release. The part number was previously included in datasheet DocID024399.
10-Mar-2014	2	Added: I ² PAKFP package Minor text changes

Please Read Carefully:

Information in this document is provided solely in connection with ST products. STMicroelectronics NV and its subsidiaries ("ST") reserve the right to make changes, corrections, modifications or improvements, to this document, and the products and services described herein at any time, without notice.

All ST products are sold pursuant to ST's terms and conditions of sale.

Purchasers are solely responsible for the choice, selection and use of the ST products and services described herein, and ST assumes no liability whatsoever relating to the choice, selection or use of the ST products and services described herein.

No license, express or implied, by estoppel or otherwise, to any intellectual property rights is granted under this document. If any part of this document refers to any third party products or services it shall not be deemed a license grant by ST for the use of such third party products or services, or any intellectual property contained therein or considered as a warranty covering the use in any manner whatsoever of such third party products or services or any intellectual property contained therein.

UNLESS OTHERWISE SET FORTH IN ST'S TERMS AND CONDITIONS OF SALE ST DISCLAIMS ANY EXPRESS OR IMPLIED WARRANTY WITH RESPECT TO THE USE AND/OR SALE OF ST PRODUCTS INCLUDING WITHOUT LIMITATION IMPLIED WARRANTIES OF MERCHANTABILITY, FITNESS FOR A PARTICULAR PURPOSE (AND THEIR EQUIVALENTS UNDER THE LAWS OF ANY JURISDICTION), OR INFRINGEMENT OF ANY PATENT, COPYRIGHT OR OTHER INTELLECTUAL PROPERTY RIGHT.

ST PRODUCTS ARE NOT DESIGNED OR AUTHORIZED FOR USE IN: (A) SAFETY CRITICAL APPLICATIONS SUCH AS LIFE SUPPORTING, ACTIVE IMPLANTED DEVICES OR SYSTEMS WITH PRODUCT FUNCTIONAL SAFETY REQUIREMENTS; (B) AERONAUTIC APPLICATIONS; (C) AUTOMOTIVE APPLICATIONS OR ENVIRONMENTS, AND/OR (D) AEROSPACE APPLICATIONS OR ENVIRONMENTS. WHERE ST PRODUCTS ARE NOT DESIGNED FOR SUCH USE, THE PURCHASER SHALL USE PRODUCTS AT PURCHASER'S SOLE RISK, EVEN IF ST HAS BEEN INFORMED IN WRITING OF SUCH USAGE, UNLESS A PRODUCT IS EXPRESSLY DESIGNATED BY ST AS BEING INTENDED FOR "AUTOMOTIVE, AUTOMOTIVE SAFETY OR MEDICAL" INDUSTRY DOMAINS ACCORDING TO ST PRODUCT DESIGN SPECIFICATIONS. PRODUCTS FORMALLY ESCC, QML OR JAN QUALIFIED ARE DEEMED SUITABLE FOR USE IN AEROSPACE BY THE CORRESPONDING GOVERNMENTAL AGENCY.

Resale of ST products with provisions different from the statements and/or technical features set forth in this document shall immediately void any warranty granted by ST for the ST product or service described herein and shall not create or extend in any manner whatsoever, any liability of ST.

ST and the ST logo are trademarks or registered trademarks of ST in various countries.

Information in this document supersedes and replaces all information previously supplied.

The ST logo is a registered trademark of STMicroelectronics. All other names are the property of their respective owners.

© 2014 STMicroelectronics - All rights reserved

STMicroelectronics group of companies

Australia - Belgium - Brazil - Canada - China - Czech Republic - Finland - France - Germany - Hong Kong - India - Israel - Italy - Japan - Malaysia - Malta - Morocco - Philippines - Singapore - Spain - Sweden - Switzerland - United Kingdom - United States of America

www.st.com





Стандарт Электрон Связь

Мы молодая и активно развивающаяся компания в области поставок электронных компонентов. Мы поставляем электронные компоненты отечественного и импортного производства напрямую от производителей и с крупнейших складов мира.

Благодаря сотрудничеству с мировыми поставщиками мы осуществляем комплексные и плановые поставки широчайшего спектра электронных компонентов.

Собственная эффективная логистика и склад в обеспечивает надежную поставку продукции в точно указанные сроки по всей России.

Мы осуществляем техническую поддержку нашим клиентам и предпродажную проверку качества продукции. На все поставляемые продукты мы предоставляем гарантию .

Осуществляем поставки продукции под контролем ВП МО РФ на предприятия военно-промышленного комплекса России , а также работаем в рамках 275 ФЗ с открытием отдельных счетов в уполномоченном банке. Система менеджмента качества компании соответствует требованиям ГОСТ ISO 9001.

Минимальные сроки поставки, гибкие цены, неограниченный ассортимент и индивидуальный подход к клиентам являются основой для выстраивания долгосрочного и эффективного сотрудничества с предприятиями радиоэлектронной промышленности, предприятиями ВПК и научно-исследовательскими институтами России.

С нами вы становитесь еще успешнее!

Наши контакты:

Телефон: +7 812 627 14 35

Электронная почта: sales@st-electron.ru

Адрес: 198099, Санкт-Петербург,
Промышленная ул, дом № 19, литера Н,
помещение 100-Н Офис 331