

Features

- 3.0V to 5.5V Operation
- Industry-standard Architecture
 - Emulates Many 20-pin PALs®
 - Low-cost Easy-to-use Software Tools
- High-speed
 - 10 ns Maximum Pin-to-pin Delay
- Ultra-low Power
 - 5 μ A (Max) Pin-controlled Power-down Mode Option
 - Typical 100 nA Standby
- CMOS and TTL Compatible Inputs and Outputs
 - I/O Pin-keeper Circuits
- Advanced Flash Technology
 - Reprogrammable
 - 100% Tested
- High-reliability CMOS Process
 - 20 Year Data Retention
 - 100 Erase/Write Cycles
 - 2,000V ESD Protection
 - 200 mA Latchup Immunity
- Commercial and Industrial Temperature Ranges
- Dual-in-line and Surface Mount Packages in Standard Pinouts
- Inputs are 5V Tolerant
- Green Package Options (Pb/Halide-free/RoHS Compliant) Available

Description

The ATF16LV8C is a high-performance EECMOS programmable logic device that utilizes Atmel's proven electrically-erasable Flash memory technology. Speeds down to 10 ns and a 5 μ A pin-controlled power-down mode option are offered. All speed
(continued)

Pin Configurations

All Pinouts Top View

Pin Name	Function
CLK	Clock
I	Logic Inputs
I/O	Bi-directional Buffers
OE	Output Enable
VCC	(+3V to 5.5V) Supply
PD	Programmable Power-down Option

TSSOP

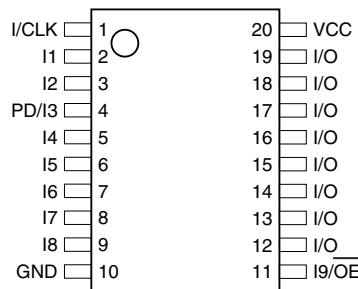

DIP/SOIC

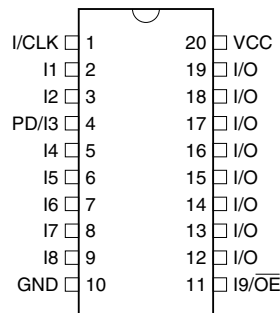

PLCC

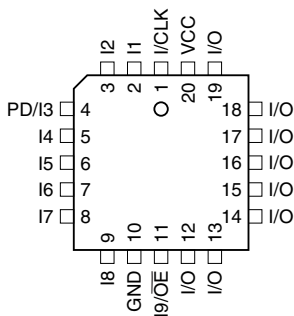

High-
performance
EE PLD

ATF16LV8C

ranges are specified over the full 3.0V to 5.25V range for industrial and commercial temperature ranges.

The ATF16LV8C incorporates a superset of the generic architectures, which allows direct replacement of the 16R8 family and most 20-pin combinatorial PLDs. Eight outputs are each allocated eight product terms. Three different modes of operation, configured automatically with software, allow highly complex logic functions to be realized.

The ATF16LV8C can significantly reduce total system power, thereby enhancing system reliability and reducing power supply costs. When pin 4 is configured as the power-down control pin, supply current drops to less than 5 μ A whenever the pin is high. If the power-down feature isn't required for a particular application, pin 4 may be used as a logic input. Also, the pin keeper circuits eliminate the need for internal pull-up resistors along with their attendant power consumption.

Block Diagram

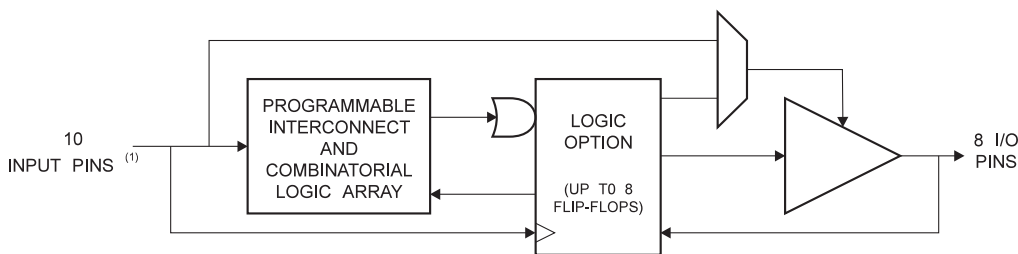

Note: 1. Includes optional PD control pin.

Absolute Maximum Ratings*

Temperature Under Bias.....	-40°C to +85°C
Storage Temperature	-65°C to +150°C
Voltage on Any Pin with Respect to Ground	-2.0V to +7.0V ⁽¹⁾
Voltage on Input Pins with Respect to Ground During Programming.....	-2.0V to +14.0V ⁽¹⁾
Programming Voltage with Respect to Ground	-2.0V to +14.0V ⁽¹⁾

*NOTICE: Stresses beyond those listed under “Absolute Maximum Ratings” may cause permanent damage to the device. This is a stress rating only and functional operation of the device at these or any other conditions beyond those indicated in the operational sections of this specification is not implied. Exposure to absolute maximum rating conditions for extended periods may affect device reliability.

Note: 1. Minimum voltage is -0.6V DC, which may undershoot to -2.0V for pulses of less than 20 ns. Maximum output pin voltage is $V_{CC} + 0.75V$ DC, which may overshoot to 7.0V for pulses of less than 20 ns.

DC and AC Operating Conditions

Commercial	
Operating Temperature (Ambient)	0°C - 70°C
V_{CC} Power Supply	3.0V to 5.5V

DC Characteristics

Symbol	Parameter	Condition ⁽²⁾	Min	Typ	Max	Units
I_{IL}	Input or I/O Low Leakage Current	$0 \leq V_{IN} \leq V_{IL}(\text{Max})$			-10	μA
I_{IH}	Input or I/O High Leakage Current	$1.8 \leq V_{IN} \leq V_{CC}$			10	μA
$I_{CC1}^{(1)}$	Power Supply Current	15 MHz, $V_{CC} = \text{Max}$, $V_{IN} = 0$, V_{CC} , Outputs Open		Com. Ind.	55 60	mA
$I_{PD}^{(1)}$	Power Supply Current, Power-down Mode	$V_{CC} = \text{Max}$, $V_{IN} = 0$, V_{CC}		0.1	5	μA
I_{OS}	Output Short Circuit Current	$V_{OUT} = 0.5\text{V}$; $V_{CC} = 3\text{V}$; $T_A = 25^\circ\text{C}$			-150	mA
V_{IL}	Input Low Voltage	$\text{MIN} < V_{CC} < \text{Max}$	-0.5		0.8	V
V_{IH}	Input High Voltage		2.0		$V_{CC} + 1$	V
V_{OL}	Output Low Voltage	$V_{CC} = \text{Min}$; All Outputs $I_{OL} = 8 \text{ mA}$			0.5	V
V_{OH}	Output High Voltage	$V_{CC} = \text{Min}$ $I_{OH} = -4 \text{ mA}$	2.4			V
I_{OL}	Output Low Current	$V_{CC} = \text{Min}$	8			mA
I_{OH}	Output High Current	$V_{CC} = \text{Min}$	-4			mA

- Note: 1. All I_{CC} parameters measured with outputs open.
2. For DC characteristics, the test condition of $V_{CC} = \text{Max}$ corresponds to 3.6V.

AC Waveforms⁽¹⁾



- Note: 1. Timing measurement reference is 1.5V. Input AC driving levels are 0.0V and 3.0V, unless otherwise specified.



AC Characteristics

Symbol	Parameter	-10		-15		Units
		Min	Max	Min	Max	
t_{PD}	Input or Feedback to Non-Registered Output	1	10	1	15	ns
t_{CF}	Clock to Feedback		5		8	ns
t_{CO}	Clock to Output	2	7	2	10	ns
t_S	Input or Feedback Setup Time	7		12		ns
t_H	Input Hold Time	0		0		ns
t_P	Clock Period	12		16		ns
t_W	Clock Width	6		8		ns
f_{MAX}	External Feedback $1/(t_S + t_{CO})$		71.4		45.5	MHz
	Internal Feedback $1/(t_S + t_{CF})$		83.3		50	MHz
	No Feedback $1/(t_P)$		83.3		62.5	MHz
t_{EA}	Input to Output Enable — Product Term	3	10	3	15	ns
t_{ER}	Input to Output Disable — Product Term	2	10	2	15	ns
t_{PZX}	\overline{OE} pin to Output Enable	2	8	2	15	ns
t_{PXZ}	\overline{OE} pin to Output Disable	1.5	8	1.5	15	ns

Power-down AC Characteristics⁽¹⁾⁽²⁾⁽³⁾

Symbol	Parameter	-10		-15		Units
		Min	Max	Min	Max	
t_{IVDH}	Valid Input before PD High	10		15		ns
t_{GVDH}	Valid \overline{OE} before PD High	0		0		ns
t_{CVDH}	Valid Clock before PD High	0		0		ns
t_{DHIX}	Input Don't Care after PD High		10		15	ns
t_{DHGX}	\overline{OE} Don't Care after PD High		10		15	ns
t_{DHCX}	Clock Don't Care after PD High		10		15	ns
t_{DLIV}	PD Low to Valid Input		10		15	ns
t_{DLGV}	PD Low to Valid \overline{OE}		25		30	ns
t_{DLCV}	PD Low to Valid Clock		25		30	ns
t_{DLOV}	PD Low to Valid Output		30		35	ns

- Notes:
1. Output data is latched and held.
 2. High-Z outputs remain High-Z.
 3. Clock and input transitions are ignored.

Input Test Waveforms and Measurement Levels:

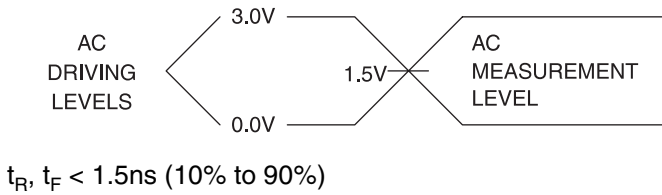

Output Test Loads: Commercial



Note: Similar devices are tested with slightly different loads. These load differences may affect output signals' delay and slew rate. Atmel devices are tested with sufficient margins to meet compatible devices.

Pin Capacitance

($f = 1\text{MHz}$, $T = 25^\circ\text{C}$)⁽¹⁾

	Typ	Max	Units	Conditions
C_{IN}	5	8	pF	$V_{IN} = 0V$
C_{OUT}	6	8	pF	$V_{OUT} = 0V$

Note: 1. Typical values for nominal supply voltage. This parameter is only sampled and is not 100% tested.

Power-up Reset

The ATF16LV8C's registers are designed to reset during power-up. At a point delayed slightly from V_{CC} crossing V_{RST} , all registers will be reset to the low state. As a result, the registered output state will always be high on power-up.

This feature is critical for state machine initialization. However, due to the asynchronous nature of reset and the uncertainty of how V_{CC} actually rises in the system, the following conditions are required:

1. The V_{CC} rise must be monotonic from below 0.7V.
2. The signals from which the clock is derived must remain stable during T_{PR} .
3. After T_{PR} , all input and feedback setup times must be met before driving the clock term high.

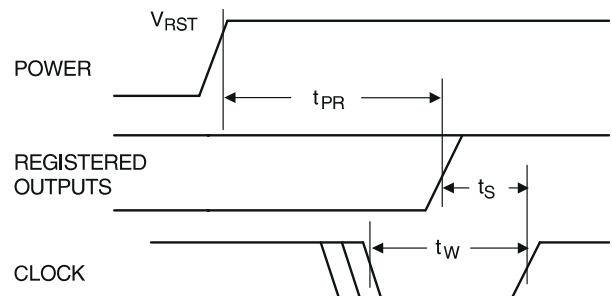

Parameter	Description	Typ	Max	Units
T_{PR}	Power-up Reset Time	600	1,000	ns
V_{RST}	Power-up Reset Voltage	2.5	3.0	V

**SUPPLY CURRENT
VS. INPUT FREQUENCY**
(VCC = 3.3V, TA = 25°C)

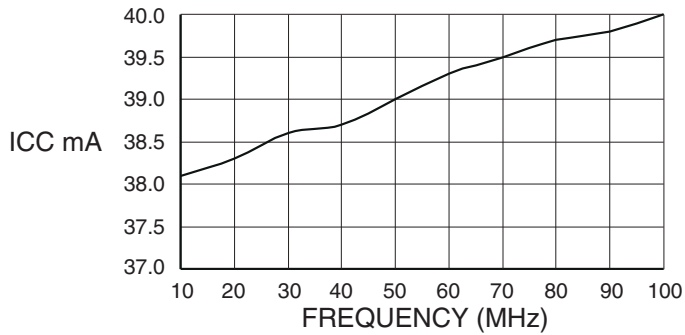

**OUTPUT SINK CURRENT
VS. OUTPUT VOLTAGE (VCC = 5V, TA = 25°C)**

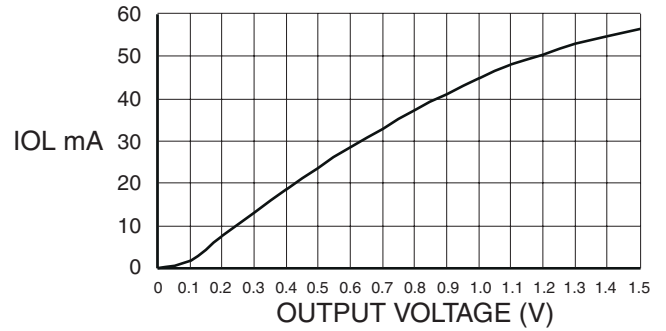

**NORMALIZED SUPPLY CURRENT
VS. AMBIENT TEMPERATURE**
(VCC = 3.3V, STANDBY)

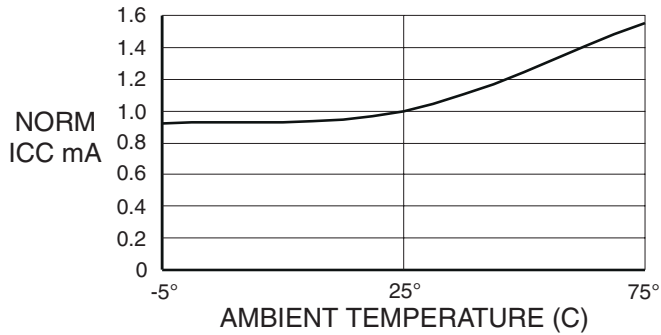

**NORMALIZED SUPPLY CURRENT
VS. SUPPLY VOLTAGE**
(TA = 25°C, STANDBY)

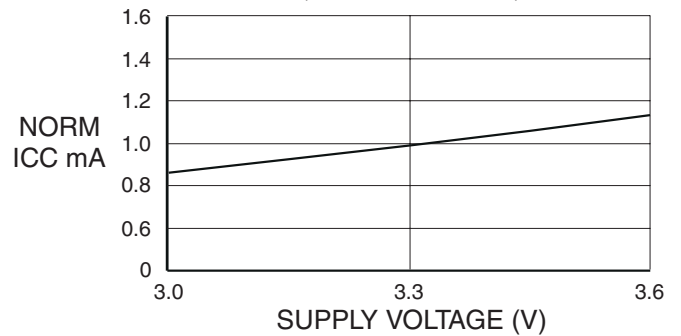

**OUTPUT SINK CURRENT
VS. SUPPLY VOLTAGE (TA = 25°C, VOL = 0.45V)**

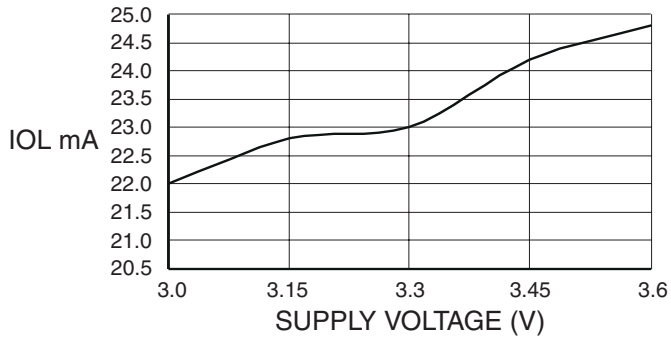

**OUTPUT SOURCE CURRENT
VS. SUPPLY VOLTAGE (VOH = 2.4V, TA = 25°C)**

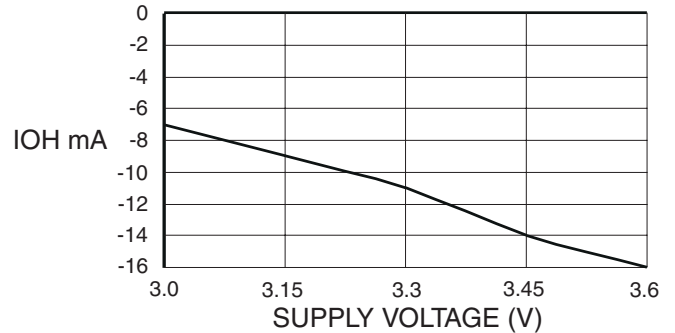

OUTPUT SOURCE CURRENT
VS. OUTPUT VOLTAGE (VCC = 5V, TA = 25°C)

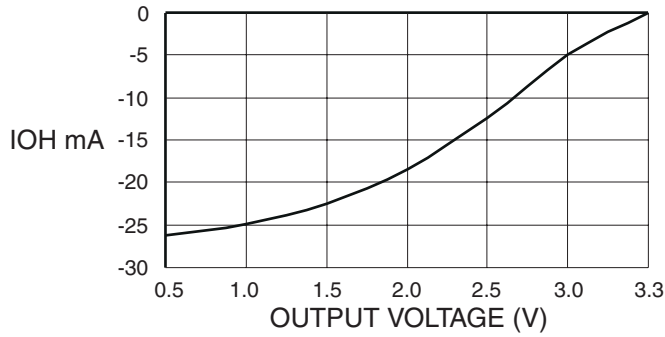

NORMALIZED t_{CO}
VS. AMBIENT TEMPERATURE (VCC = 3.3V)

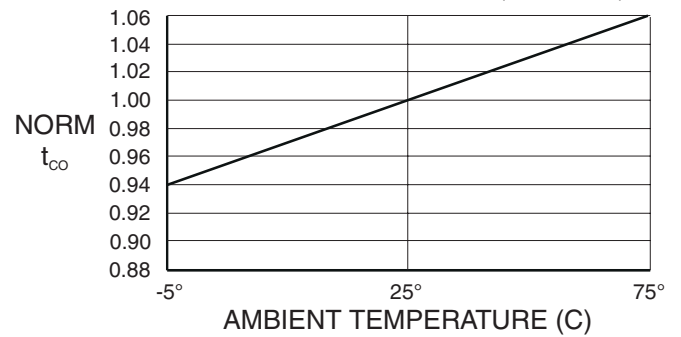

NORMALIZED t_{PD}
VS. SUPPLY VOLTAGE (TA = 25°C)

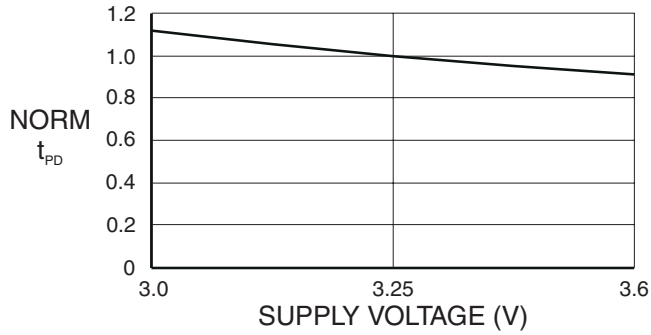

NORMALIZED t_s
VS. AMBIENT TEMPERATURE (VCC = 3.3V)

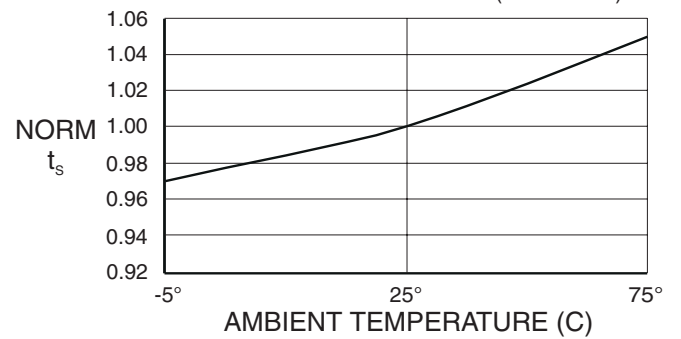

NORMALIZED t_{PD}
VS. AMBIENT TEMPERATURE (VCC = 3.3V)

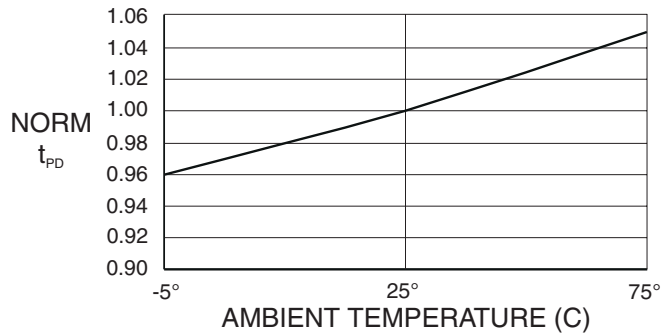

NORMALIZED t_H
VS. AMBIENT TEMPERATURE (VCC = 3.3V)

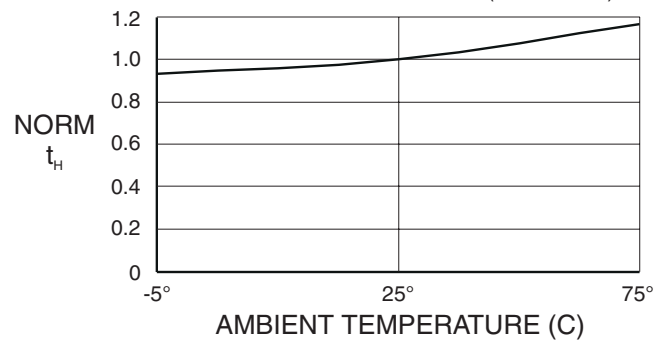

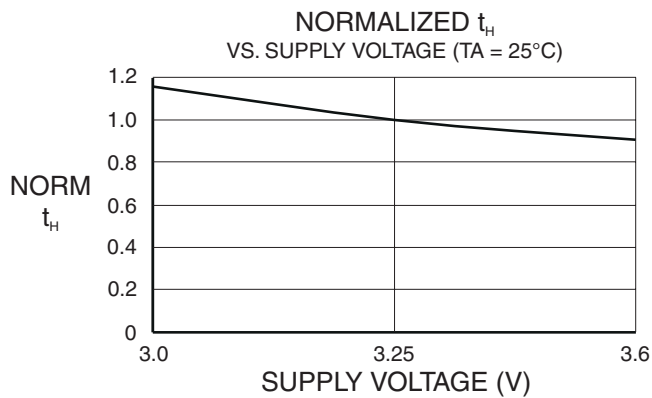
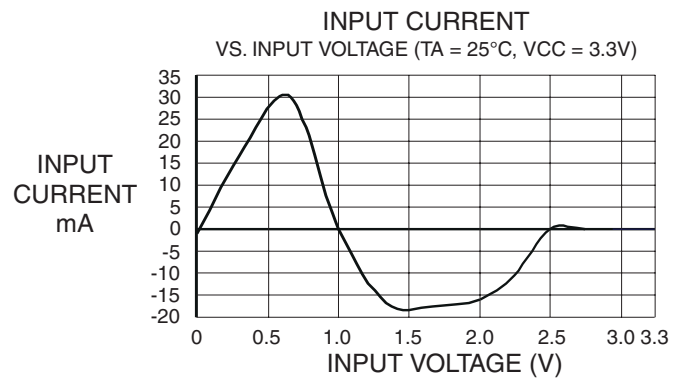
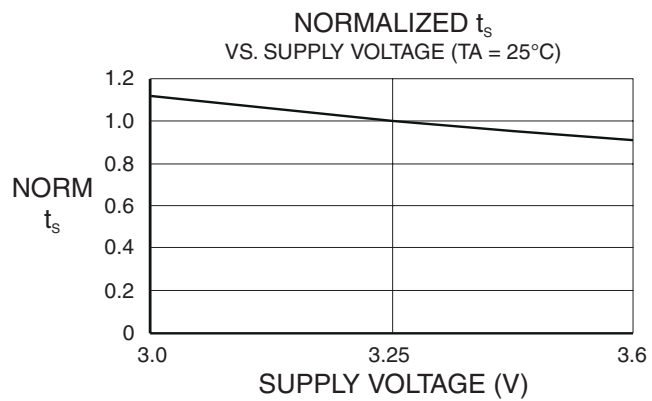
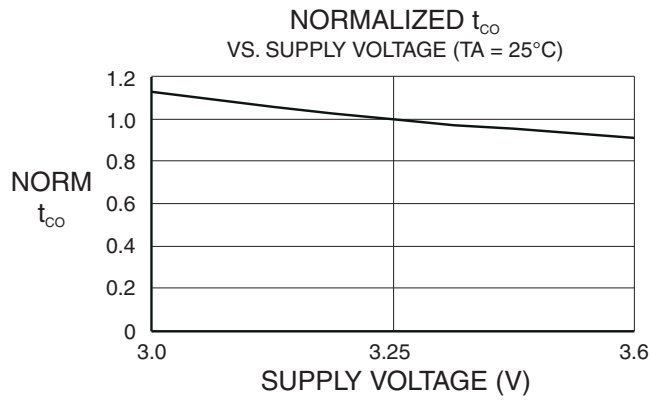

Ordering Information

t_{PD} (ns)	t_S (ns)	t_{CO} (ns)	Ordering Code	Package	Operation Range
10	7	7	ATF16LV8C-10JC ATF16LV8C-10PC ATF16LV8C-10SC ATF16LV8C-10XC	20J 20P3 20S 20X	Commercial (0°C to 70°C)
15	12	10	ATF16LV8C-15JC ATF16LV8C-15PC ATF16LV8C-15SC ATF16LV8C-15XC	20J 20P3 20S 20X	Commercial (0°C to 70°C)
10	7	7	ATF16LV8C-10JI ATF16LV8C-10PI ATF16LV8C-10SI ATF16LV8C-10XI	20J 20P3 20S 20X	Industrial (-40°C to 85°C)
15	12	10	ATF16LV8C-15JI ATF16LV8C-15PI ATF16LV8C-15SI ATF16LV8C-15XI	20J 20P3 20S 20X	Industrial (-40°C to 85°C)

Green Package Options (Pb/Halide-free/RoHS Compliant)

t_{PD} (ns)	t_S (ns)	t_{CO} (ns)	Ordering Code	Package	Operation Range
10	7	7	ATF16LV8C-10JU ATF16LV8C-10SU ATF16LV8C-10XU	20J 20S 20X	Industrial (-40°C to 85°C)

Using “C” Product for Industrial

To use commercial product for industrial temperature ranges, simply de-rate I_{CC} by 15% on the “C” device. No speed de-rating is necessary.

Package Type	
20J	20-lead, Plastic J-leaded Chip Carrier (PLCC)
20P3	20-lead, 0.300" Wide, Plastic Dual Inline Package (PDIP)
20S	20-lead, 0.300" Wide, Plastic Gull-wing Small Outline (SOIC)
20X	20-lead, 4.4 mm Wide, Plastic Thin Shrink Small Outline (TSSOP)

Packaging Information

20J – PLCC

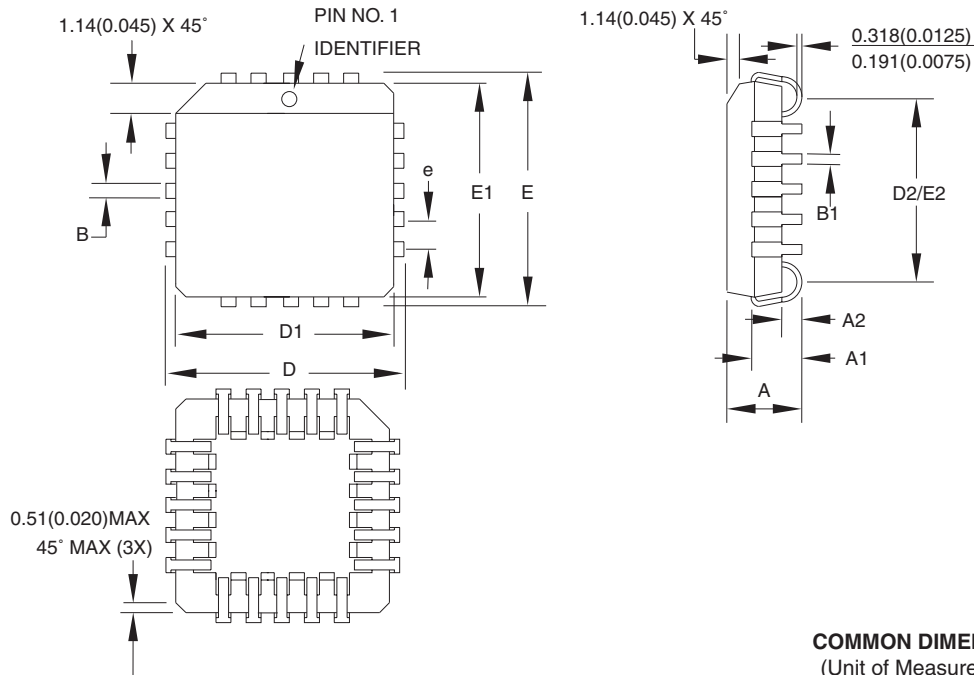

COMMON DIMENSIONS
(Unit of Measure = mm)

SYMBOL	MIN	NOM	MAX	NOTE
A	4.191	–	4.572	
A1	2.286	–	3.048	
A2	0.508	–	–	
D	9.779	–	10.033	
D1	8.890	–	9.042	Note 2
E	9.779	–	10.033	
E1	8.890	–	9.042	Note 2
D2/E2	7.366	–	8.382	
B	0.660	–	0.813	
B1	0.330	–	0.533	
e	1.270 TYP			

- Notes:
1. This package conforms to JEDEC reference MS-018, Variation AA.
 2. Dimensions D1 and E1 do not include mold protrusion. Allowable protrusion is .010"(0.254 mm) per side. Dimension D1 and E1 include mold mismatch and are measured at the extreme material condition at the upper or lower parting line.
 3. Lead coplanarity is 0.004" (0.102 mm) maximum.

10/04/01



2325 Orchard Parkway
San Jose, CA 95131

TITLE

20J, 20-lead, Plastic J-leaded Chip Carrier (PLCC)

DRAWING NO.

20J

REV.

B

20P3 – PDIP



COMMON DIMENSIONS
(Unit of Measure = mm)

SYMBOL	MIN	NOM	MAX	NOTE
A	–	–	5.334	
A1	0.381	–	–	
D	24.892	–	26.924	Note 2
E	7.620	–	8.255	
E1	6.096	–	7.112	Note 2
B	0.356	–	0.559	
B1	1.270	–	1.551	
L	2.921	–	3.810	
C	0.203	–	0.356	
eB	–	–	10.922	
eC	0.000	–	1.524	
e	2.540 TYP			

- Notes:
1. This package conforms to JEDEC reference MS-001, Variation AD.
 2. Dimensions D and E1 do not include mold Flash or Protrusion. Mold Flash or Protrusion shall not exceed 0.25 mm (0.010").

1/23/04



2325 Orchard Parkway
San Jose, CA 95131

TITLE

20P3, 20-lead (0.300"/7.62 mm Wide) Plastic Dual
Inline Package (PDIP)

DRAWING NO.

20P3

REV.

D



20S – SOIC

Dimensions in Millimeters and (Inches).
 Controlling dimension: Inches.
 JEDEC Standard MS-013

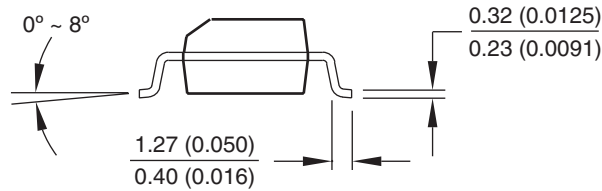
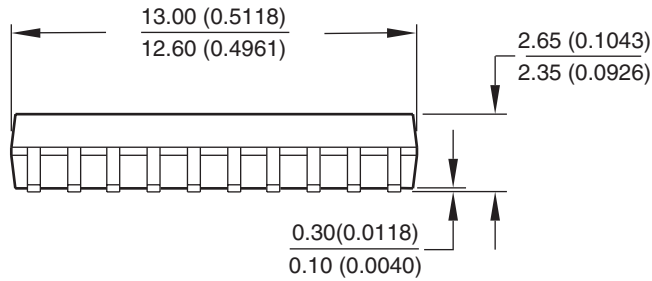
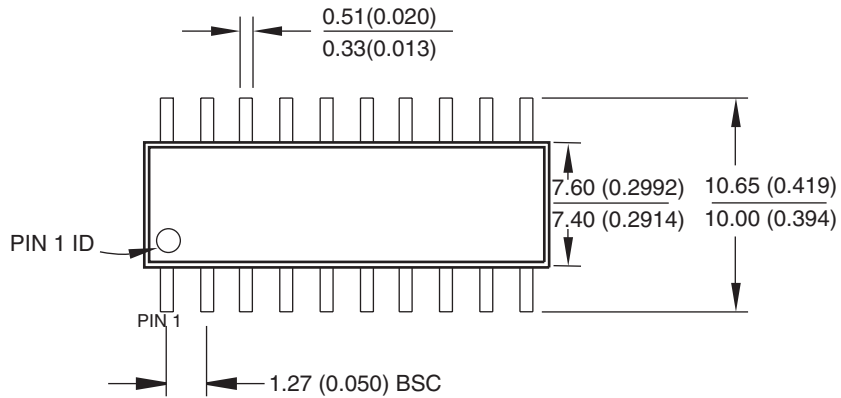

10/23/03



2325 Orchard Parkway
 San Jose, CA 95131

TITLE

20S, 20-lead, 0.300" Body, Plastic Gull Wing Small Outline (SOIC)

DRAWING NO.

20S

REV.

B

20X – TSSOP

Dimensions in Millimeters and (Inches).
 Controlling dimension: Millimeters.
 JEDEC Standard MO-153 AC

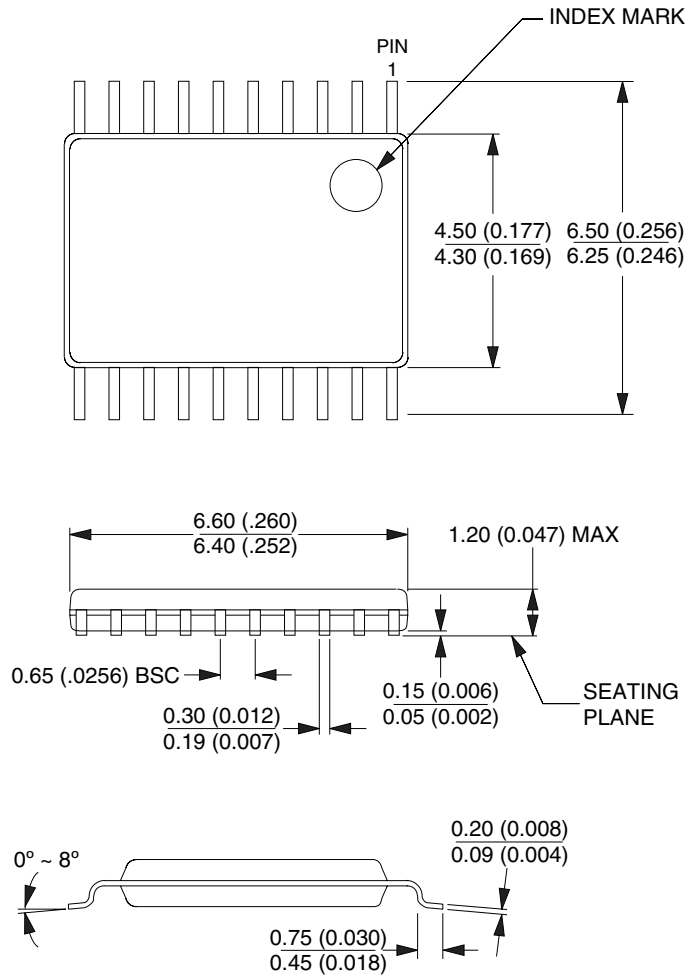

10/23/03



2325 Orchard Parkway
 San Jose, CA 95131

TITLE

20X, (Formerly 20T), 20-lead, 4.4 mm Body Width,
 Plastic Thin Shrink Small Outline Package (TSSOP)

DRAWING NO.

20X

REV.

C





Revision History

Revision Level – Revision Date	History
H – June 2006	Added Green package options.



Atmel Corporation

2325 Orchard Parkway
San Jose, CA 95131, USA
Tel: 1(408) 441-0311
Fax: 1(408) 487-2600

Regional Headquarters

Europe

Atmel Sarl
Route des Arsenalux 41
Case Postale 80
CH-1705 Fribourg
Switzerland
Tel: (41) 26-426-5555
Fax: (41) 26-426-5500

Asia

Room 1219
Chinachem Golden Plaza
77 Mody Road Tsimshatsui
East Kowloon
Hong Kong
Tel: (852) 2721-9778
Fax: (852) 2722-1369

Japan

9F, Tonetsu Shinkawa Bldg.
1-24-8 Shinkawa
Chuo-ku, Tokyo 104-0033
Japan
Tel: (81) 3-3523-3551
Fax: (81) 3-3523-7581

Atmel Operations

Memory

2325 Orchard Parkway
San Jose, CA 95131, USA
Tel: 1(408) 441-0311
Fax: 1(408) 436-4314

Microcontrollers

2325 Orchard Parkway
San Jose, CA 95131, USA
Tel: 1(408) 441-0311
Fax: 1(408) 436-4314

La Chantrerie
BP 70602
44306 Nantes Cedex 3, France
Tel: (33) 2-40-18-18-18
Fax: (33) 2-40-18-19-60

ASIC/ASSP/Smart Cards

Zone Industrielle
13106 Rousset Cedex, France
Tel: (33) 4-42-53-60-00
Fax: (33) 4-42-53-60-01

1150 East Cheyenne Mtn. Blvd.
Colorado Springs, CO 80906, USA
Tel: 1(719) 576-3300
Fax: 1(719) 540-1759

Scottish Enterprise Technology Park
Maxwell Building
East Kilbride G75 0QR, Scotland
Tel: (44) 1355-803-000
Fax: (44) 1355-242-743

RF/Automotive

Theresienstrasse 2
Postfach 3535
74025 Heilbronn, Germany
Tel: (49) 71-31-67-0
Fax: (49) 71-31-67-2340

1150 East Cheyenne Mtn. Blvd.
Colorado Springs, CO 80906, USA
Tel: 1(719) 576-3300
Fax: 1(719) 540-1759

Biometrics/Imaging/Hi-Rel MPU/ High-Speed Converters/RF Datacom

Avenue de Rochepleine
BP 123
38521 Saint-Egreve Cedex, France
Tel: (33) 4-76-58-30-00
Fax: (33) 4-76-58-34-80

Literature Requests

www.atmel.com/literature

Disclaimer: The information in this document is provided in connection with Atmel products. No license, express or implied, by estoppel or otherwise, to any intellectual property right is granted by this document or in connection with the sale of Atmel products. **EXCEPT AS SET FORTH IN ATMEL'S TERMS AND CONDITIONS OF SALE LOCATED ON ATMEL'S WEB SITE, ATMEL ASSUMES NO LIABILITY WHATSOEVER AND DISCLAIMS ANY EXPRESS, IMPLIED OR STATUTORY WARRANTY RELATING TO ITS PRODUCTS INCLUDING, BUT NOT LIMITED TO, THE IMPLIED WARRANTY OF MERCHANTABILITY, FITNESS FOR A PARTICULAR PURPOSE, OR NON-INFRINGEMENT. IN NO EVENT SHALL ATMEL BE LIABLE FOR ANY DIRECT, INDIRECT, CONSEQUENTIAL, PUNITIVE, SPECIAL OR INCIDENTAL DAMAGES (INCLUDING, WITHOUT LIMITATION, DAMAGES FOR LOSS OF PROFITS, BUSINESS INTERRUPTION, OR LOSS OF INFORMATION) ARISING OUT OF THE USE OR INABILITY TO USE THIS DOCUMENT, EVEN IF ATMEL HAS BEEN ADVISED OF THE POSSIBILITY OF SUCH DAMAGES.** Atmel makes no representations or warranties with respect to the accuracy or completeness of the contents of this document and reserves the right to make changes to specifications and product descriptions at any time without notice. Atmel does not make any commitment to update the information contained herein. Unless specifically provided otherwise, Atmel products are not suitable for, and shall not be used in, automotive applications. Atmel's products are not intended, authorized, or warranted for use as components in applications intended to support or sustain life.

© 2006 Atmel Corporation. All rights reserved. Atmel®, logo and combinations thereof, Everywhere You Are® and others are registered trademarks or trademarks of Atmel Corporation or its subsidiaries. Other terms and product names may be trademarks of others.

Mouser Electronics

Authorized Distributor

Click to View Pricing, Inventory, Delivery & Lifecycle Information:

[Microchip:](#)

[ATF16LV8C-10XU](#) [ATF16LV8C-10JU](#)



Стандарт Электрон Связь

Мы молодая и активно развивающаяся компания в области поставок электронных компонентов. Мы поставляем электронные компоненты отечественного и импортного производства напрямую от производителей и с крупнейших складов мира.

Благодаря сотрудничеству с мировыми поставщиками мы осуществляем комплексные и плановые поставки широчайшего спектра электронных компонентов.

Собственная эффективная логистика и склад в обеспечивает надежную поставку продукции в точно указанные сроки по всей России.

Мы осуществляем техническую поддержку нашим клиентам и предпродажную проверку качества продукции. На все поставляемые продукты мы предоставляем гарантию .

Осуществляем поставки продукции под контролем ВП МО РФ на предприятия военно-промышленного комплекса России , а также работаем в рамках 275 ФЗ с открытием отдельных счетов в уполномоченном банке. Система менеджмента качества компании соответствует требованиям ГОСТ ISO 9001.

Минимальные сроки поставки, гибкие цены, неограниченный ассортимент и индивидуальный подход к клиентам являются основой для выстраивания долгосрочного и эффективного сотрудничества с предприятиями радиоэлектронной промышленности, предприятиями ВПК и научно-исследовательскими институтами России.

С нами вы становитесь еще успешнее!

Наши контакты:

Телефон: +7 812 627 14 35

Электронная почта: sales@st-electron.ru

Адрес: 198099, Санкт-Петербург,
Промышленная ул, дом № 19, литера Н,
помещение 100-Н Офис 331