

Features

- Low on-voltage drop ($V_{CE(sat)}$)
- Low C_{res} / C_{ies} ratio (no cross conduction susceptibility)
- Short-circuit withstand time 10 μ s
- IGBT co-packaged with ultra fast free-wheeling diode

Applications

- High frequency inverters
- Motor drivers

Description

This IGBT utilizes the advanced PowerMESH™ process resulting in an excellent trade-off between switching performance and low on-state behavior.

Figure 1. Internal schematic diagram

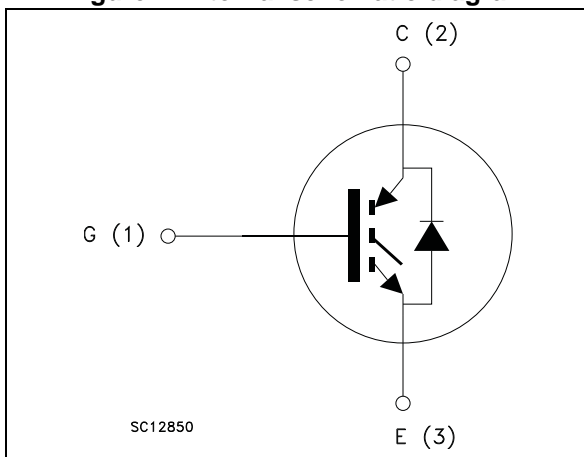

Table 1. Device summary

Order code	Marking	Package	Packaging
STGW40NC60KD	GW40NC60KD	TO-247	Tube

Contents

1	Electrical ratings	3
2	Electrical characteristics	4
	2.1 Electrical characteristics (curves)	6
3	Test circuits	9
4	Package mechanical data	10
5	Revision history	12

1 Electrical ratings

Table 2. Absolute maximum ratings

Symbol	Parameter	Value	Unit
V_{CES}	Collector-emitter voltage ($V_{GE} = 0$)	600	V
$I_C^{(1)}$	Collector current (continuous) at $T_C = 25\text{ °C}$	70	A
$I_C^{(1)}$	Collector current (continuous) at $T_C = 100\text{ °C}$	38	A
$I_{CL}^{(2)}$	Turn-off latching current	220	A
$I_{CP}^{(3)}$	Pulsed collector current	220	A
V_{GE}	Gate-emitter voltage	± 20	V
I_F	Diode RMS forward current at $T_C = 25\text{ °C}$	30	A
I_{FSM}	Surge non repetitive forward current $t_p = 10\text{ ms}$ sinusoidal	120	A
P_{TOT}	Total dissipation at $T_C = 25\text{ °C}$	250	W
t_{scw}	Short circuit withstand time, $V_{CE} = 0.5 V_{(BR)CES}$ $T_j = 125\text{ °C}$, $R_G = 10\ \Omega$, $V_{GE} = 12\text{ V}$	10	μs
T_j	Operating junction temperature	- 55 to 150	$^{\circ}\text{C}$

1. Calculated according to the iterative formula:

$$I_c(T_c) = \frac{T_{J(MAX)} - T_c}{R_{thj-c} \times V_{CE(sat)(MAX)} \cdot (T_c \cdot I_c)}$$

2. $V_{clamp} = 80\% \cdot (V_{CES})$, $T_j = 150\text{ °C}$, $R_G = 10\ \Omega$, $V_{GE} = 15\text{ V}$
 3. Pulse width limited by max. junction temperature allowed

Table 3. Thermal resistance

Symbol	Parameter	Value	Unit
$R_{thj-case}$	Thermal resistance junction-case IGBT max.	0.5	$^{\circ}\text{C}/\text{W}$
	Thermal resistance junction-case diode max.	1.5	$^{\circ}\text{C}/\text{W}$
$R_{thj-amb}$	Thermal resistance junction-ambient max	50	$^{\circ}\text{C}/\text{W}$

2 Electrical characteristics

T_{CASE}=25°C unless otherwise specified.

Table 4. Static

Symbol	Parameter	Test conditions	Min.	Typ.	Max.	Unit
V _{(BR)CES}	Collector-emitter breakdown voltage (V _{GE} = 0)	I _C = 1 mA	600			V
V _{CE(sat)}	Collector-emitter saturation voltage	V _{GE} = 15 V, I _C = 30 A		2.1	2.7	V
		V _{GE} = 15 V, I _C = 30 A, T _C = 125 °C		1.9		V
I _{CES}	Collector cut-off current (V _{GE} = 0)	V _{CE} = 600 V			500	μA
		V _{CE} = 600 V, T _C = 125 °C			5	mA
V _{GE(th)}	Gate threshold voltage	V _{CE} = V _{GE} , I _C = 250 μA	4.5		6.5	V
I _{GES}	Gate-emitter cut-off current (V _{CE} = 0)	V _{GE} = ±20 V			±100	nA
g _{fs} ⁽¹⁾	Forward transconductance	V _{CE} = 15 V, I _C = 30 A		20		S

1. Pulsed: Pulse duration = 300 μs, duty cycle 1.5%

Table 5. Dynamic

Symbol	Parameter	Test conditions	Min.	Typ.	Max.	Unit
C _{ies}	Input capacitance	V _{CE} = 25 V, f = 1 MHz, V _{GE} = 0	-	2870	-	pF
C _{oes}	Output capacitance			295		pF
C _{res}	Reverse transfer capacitance			69		pF
Q _g	Total gate charge	V _{CE} = 480 V, I _C = 30 A,	-	135	-	nC
Q _{ge}	Gate-emitter charge	V _{GE} = 15 V		27		nC
Q _{gc}	Gate-collector charge	(see Figure 18)		69.5		nC

Table 6. Switching on/off (inductive load)

Symbol	Parameter	Test conditions	Min.	Typ.	Max.	Unit
$t_{d(on)}$ t_r $(di/dt)_{on}$	Turn-on delay time Current rise time Turn-on current slope	$V_{CC} = 480\text{ V}$, $I_C = 30\text{ A}$ $R_G = 10\ \Omega$, $V_{GE} = 15\text{ V}$, (see Figure 17)	-	46 18.5 1530	-	ns ns A/ μ s
$t_{d(on)}$ t_r $(di/dt)_{on}$	Turn-on delay time Current rise time Turn-on current slope	$V_{CC} = 480\text{ V}$, $I_C = 30\text{ A}$ $R_G = 10\ \Omega$, $V_{GE} = 15\text{ V}$, $T_C = 125\text{ }^\circ\text{C}$ (see Figure 17)	-	45 19 1400	-	ns ns A/ μ s
$t_{r(Voff)}$ $t_{d(off)}$ t_f	Off voltage rise time Turn-off delay time Current fall time	$V_{CC} = 480\text{ V}$, $I_C = 30\text{ A}$ $R_G = 10\ \Omega$, $V_{GE} = 15\text{ V}$, (see Figure 17)	-	38 164 87	-	ns ns ns
$t_{r(Voff)}$ $t_{d(off)}$ t_f	Off voltage rise time Turn-off delay time Current fall time	$V_{CC} = 480\text{ V}$, $I_C = 30\text{ A}$, $R_G = 10\ \Omega$, $V_{GE} = 15\text{ V}$ $T_C = 125\text{ }^\circ\text{C}$ (see Figure 17)	-	70 208 130	-	ns ns ns

Table 7. Switching energy (inductive load)

Symbol	Parameter	Test conditions	Min.	Typ.	Max.	Unit
E_{on} $E_{off}^{(1)}$ E_{ts}	Turn-on switching losses Turn-off switching losses Total switching losses	$V_{CC} = 480\text{ V}$, $I_C = 30\text{ A}$ $R_G = 10\ \Omega$, $V_{GE} = 15\text{ V}$, (see Figure 17)	-	595 716 1311	-	μ J μ J μ J
E_{on} $E_{off}^{(1)}$ E_{ts}	Turn-on switching losses Turn-off switching losses Total switching losses	$V_{CC} = 480\text{ V}$, $I_C = 30\text{ A}$ $R_G = 10\ \Omega$, $V_{GE} = 15\text{ V}$, $T_C = 125\text{ }^\circ\text{C}$ (see Figure 17)	-	808 1200 2008	-	μ J μ J μ J

1. Turn-off losses include also the tail of the collector current.

Table 8. Collector-emitter diode

Symbol	Parameter	Test conditions	Min.	Typ.	Max.	Unit
V_F	Forward on-voltage	$I_F = 30\text{ A}$ $I_F = 30\text{ A}$, $T_C = 125\text{ }^\circ\text{C}$	-	2.4 1.8	-	V V
t_{rr} Q_{rr} I_{rrm}	Reverse recovery time Reverse recovery charge Reverse recovery current	$I_F = 30\text{ A}$, $V_R = 50\text{ V}$, $di/dt = 100\text{ A}/\mu\text{s}$ (see Figure 20)	-	45 56 2.55	-	ns nC A
t_{rr} Q_{rr} I_{rrm}	Reverse recovery time Reverse recovery charge Reverse recovery current	$I_F = 30\text{ A}$, $V_R = 50\text{ V}$, $T_C = 125\text{ }^\circ\text{C}$, $di/dt = 100\text{ A}/\mu\text{s}$ (see Figure 20)	-	100 290 5.8	-	ns nC A

2.1 Electrical characteristics (curves)

Figure 2. Output characteristics

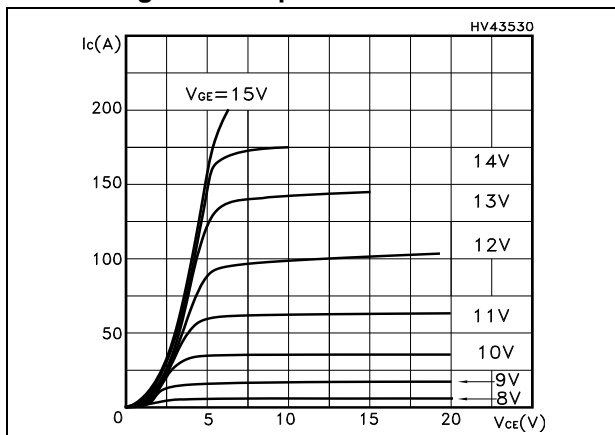

Figure 3. Transfer characteristics

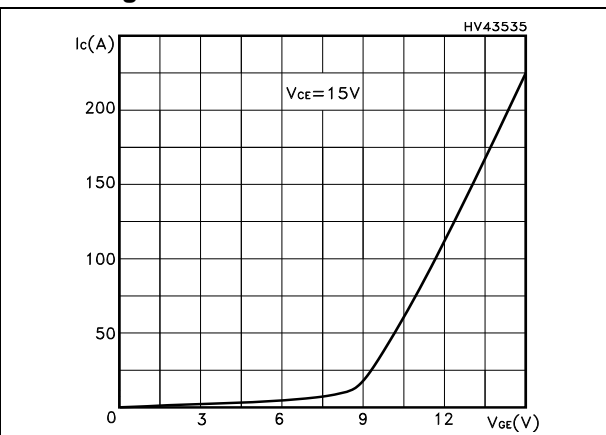

Figure 4. Transconductance

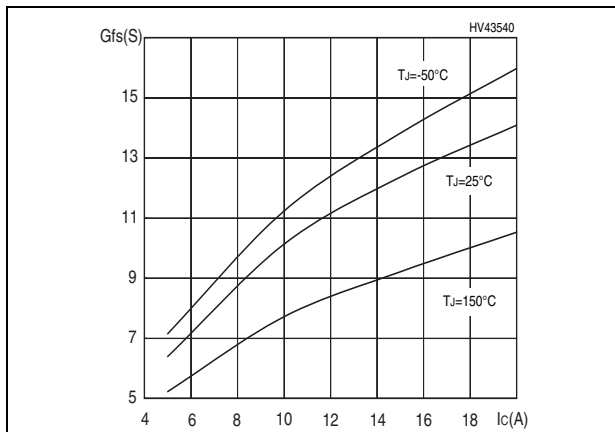

Figure 5. Collector-emitter on voltage vs. temperature

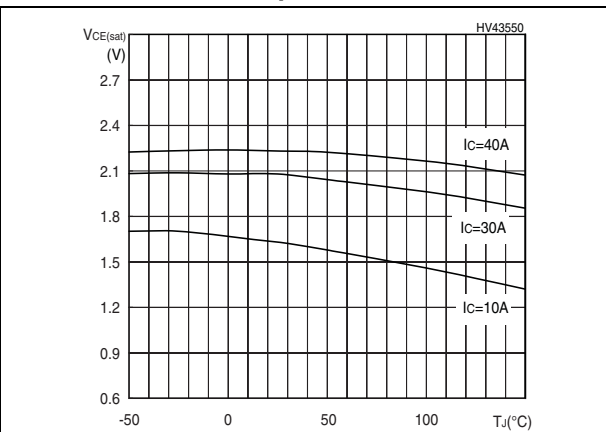

Figure 6. Gate charge vs. gate-source voltage

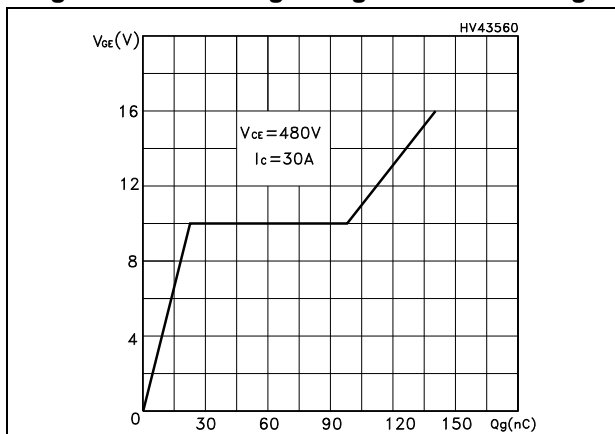

Figure 7. Capacitance variations

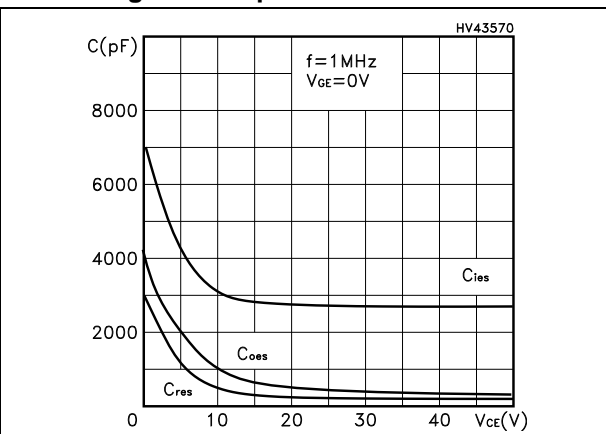

Figure 8. Normalized gate threshold voltage vs. temperature

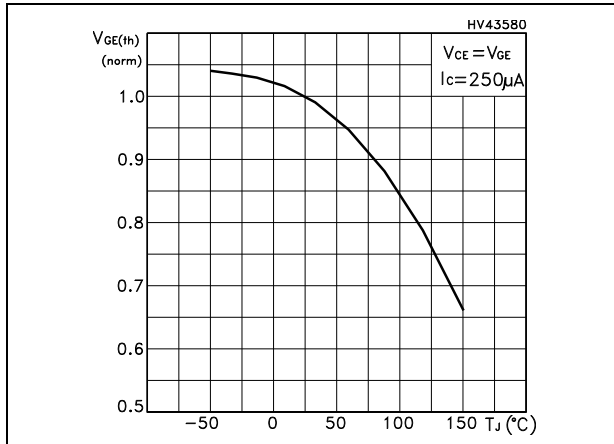

Figure 9. Collector-emitter on voltage vs. collector current

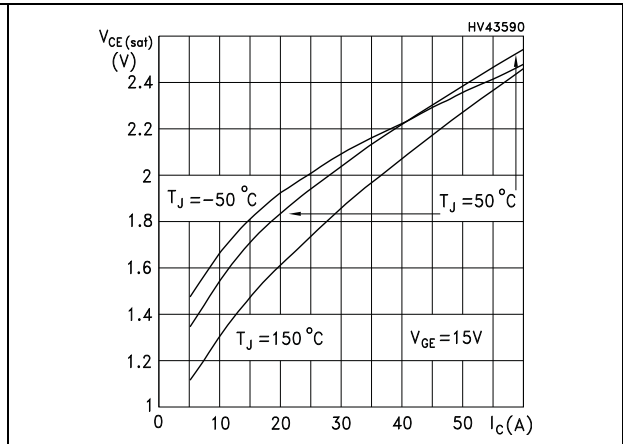

Figure 10. Normalized breakdown voltage vs. temperature

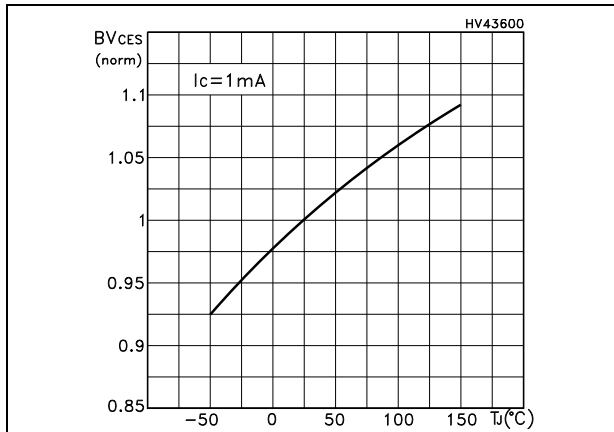

Figure 11. Switching losses vs. temperature

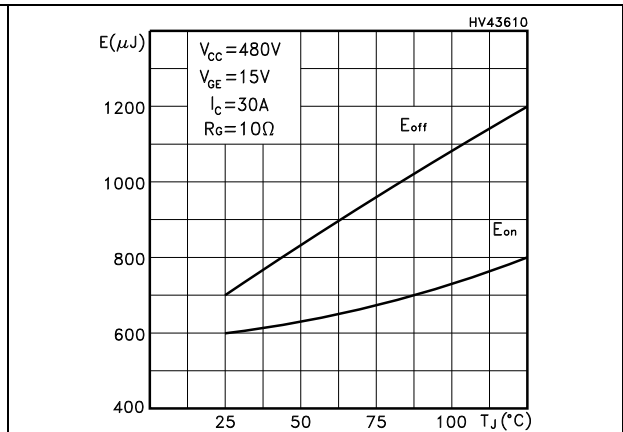

Figure 12. Switching losses vs. gate resistance

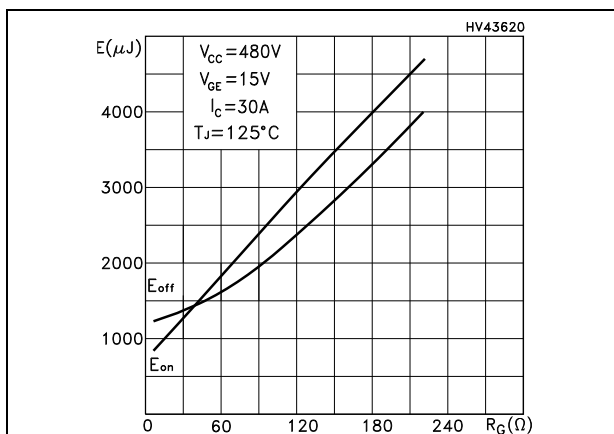

Figure 13. Switching losses vs. collector current

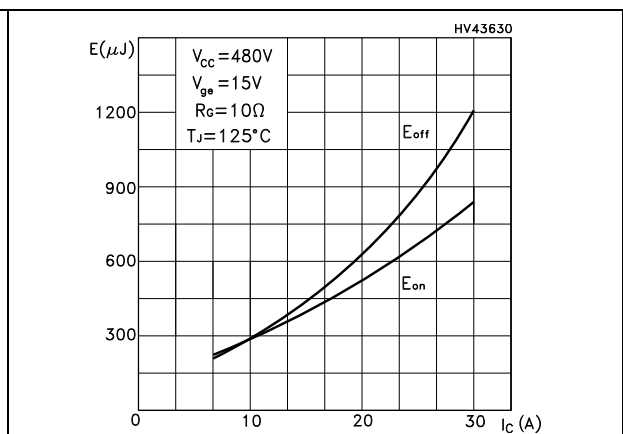

Figure 14. Thermal Impedance

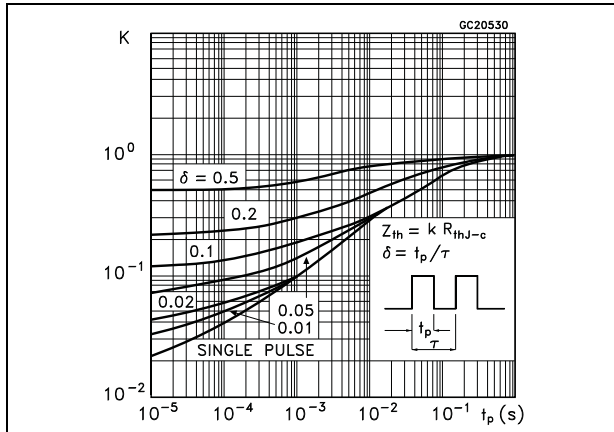

Figure 15. Turn-off SOA

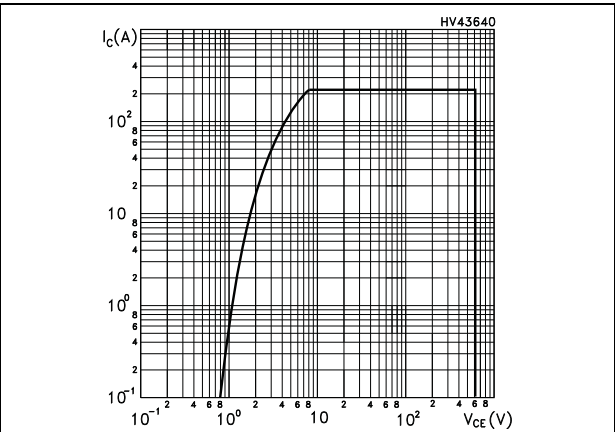
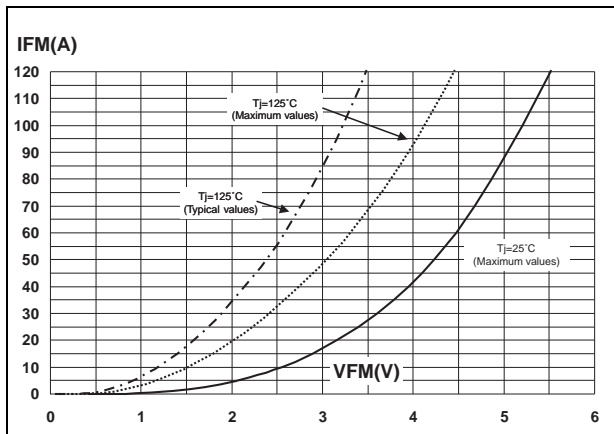

Figure 16. Forward voltage drop vs. forward current



3 Test circuits

Figure 17. Test circuit for inductive load switching

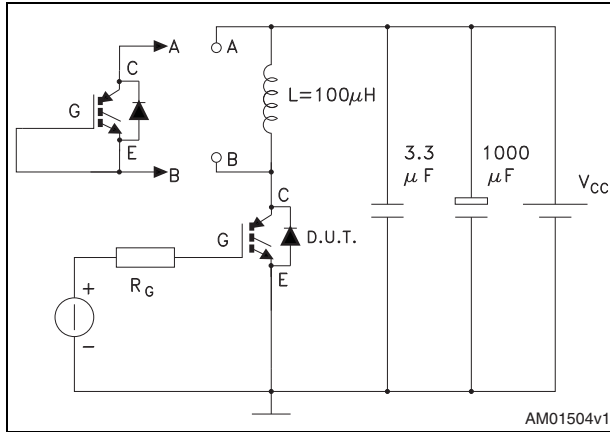

Figure 18. Gate charge test circuit

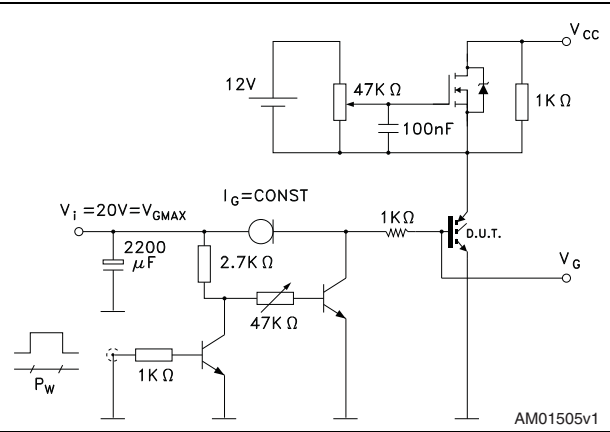

Figure 19. Switching waveform

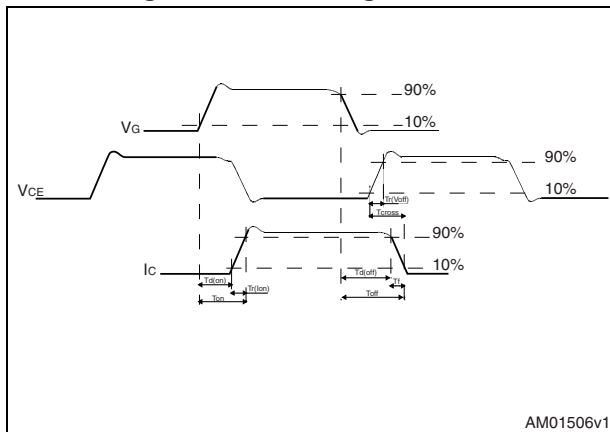
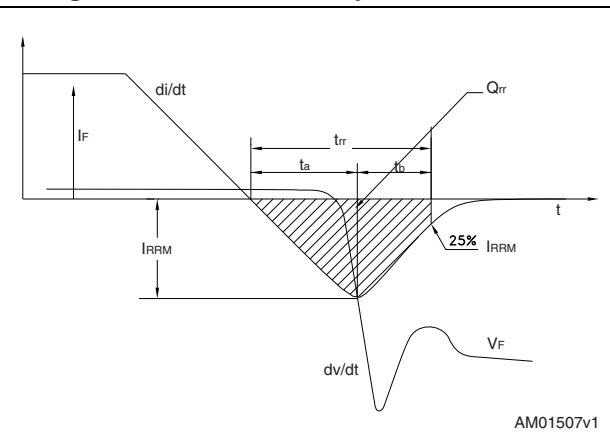

Figure 20. Diode recovery time waveform



4 Package mechanical data

In order to meet environmental requirements, ST offers these devices in different grades of ECOPACK® packages, depending on their level of environmental compliance. ECOPACK® specifications, grade definitions and product status are available at: www.st.com. ECOPACK® is an ST trademark.

Figure 21. TO-247 drawing

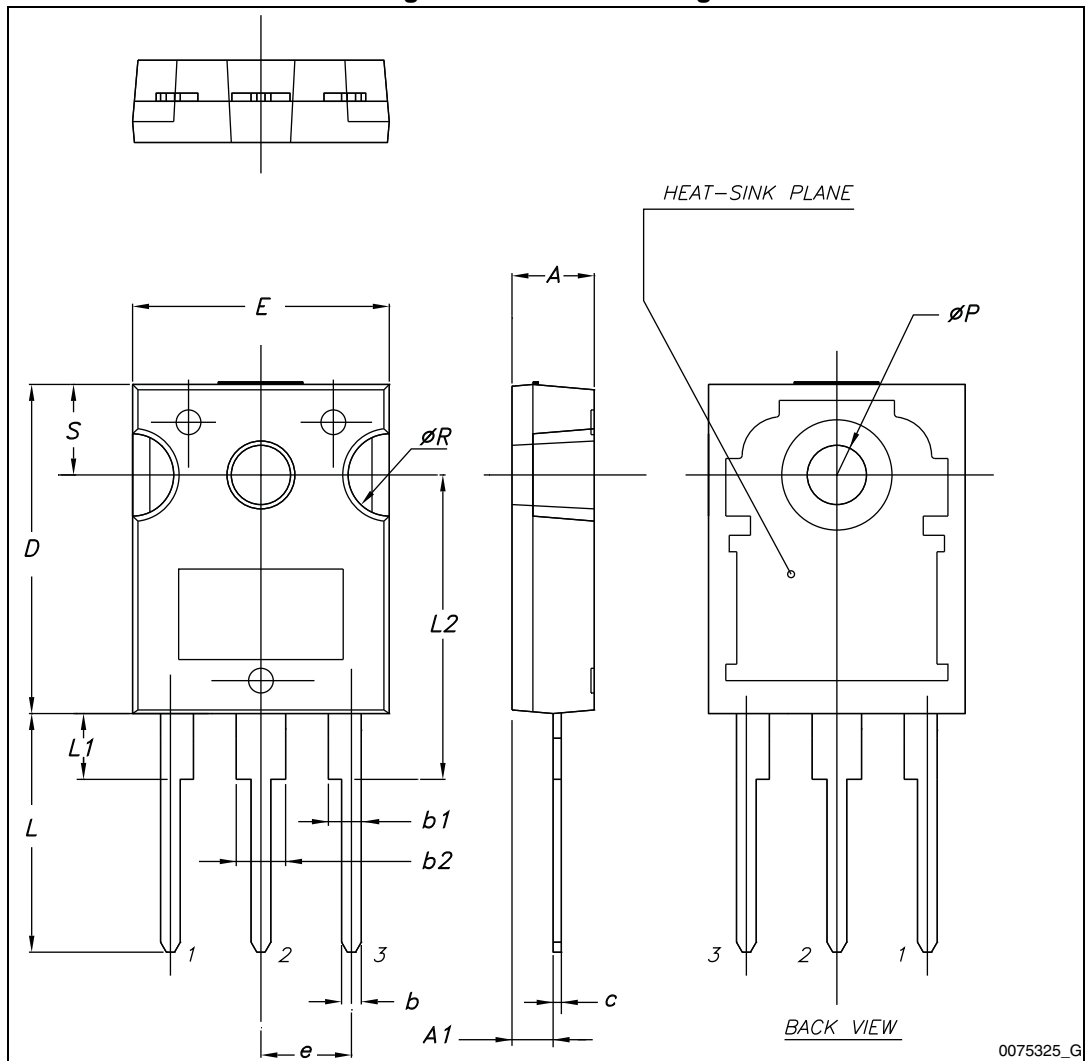

Table 9. TO-247 mechanical data

Dim.	mm.		
	Min.	Typ.	Max.
A	4.85		5.15
A1	2.20		2.60
b	1.0		1.40
b1	2.0		2.40
b2	3.0		3.40
c	0.40		0.80
D	19.85		20.15
E	15.45		15.75
e	5.30	5.45	5.60
L	14.20		14.80
L1	3.70		4.30
L2		18.50	
ØP	3.55		3.65
ØR	4.50		5.50
S	5.30	5.50	5.70

5 Revision history

Table 10. Document revision history

Date	Revision	Changes
11-Jun-2008	1	Initial release
12-Mar-2014	2	Modified total switching losses typical value in Table 7: Switching energy (inductive load) . Minor text changes.

Please Read Carefully:

Information in this document is provided solely in connection with ST products. STMicroelectronics NV and its subsidiaries ("ST") reserve the right to make changes, corrections, modifications or improvements, to this document, and the products and services described herein at any time, without notice.

All ST products are sold pursuant to ST's terms and conditions of sale.

Purchasers are solely responsible for the choice, selection and use of the ST products and services described herein, and ST assumes no liability whatsoever relating to the choice, selection or use of the ST products and services described herein.

No license, express or implied, by estoppel or otherwise, to any intellectual property rights is granted under this document. If any part of this document refers to any third party products or services it shall not be deemed a license grant by ST for the use of such third party products or services, or any intellectual property contained therein or considered as a warranty covering the use in any manner whatsoever of such third party products or services or any intellectual property contained therein.

UNLESS OTHERWISE SET FORTH IN ST'S TERMS AND CONDITIONS OF SALE ST DISCLAIMS ANY EXPRESS OR IMPLIED WARRANTY WITH RESPECT TO THE USE AND/OR SALE OF ST PRODUCTS INCLUDING WITHOUT LIMITATION IMPLIED WARRANTIES OF MERCHANTABILITY, FITNESS FOR A PARTICULAR PURPOSE (AND THEIR EQUIVALENTS UNDER THE LAWS OF ANY JURISDICTION), OR INFRINGEMENT OF ANY PATENT, COPYRIGHT OR OTHER INTELLECTUAL PROPERTY RIGHT.

ST PRODUCTS ARE NOT DESIGNED OR AUTHORIZED FOR USE IN: (A) SAFETY CRITICAL APPLICATIONS SUCH AS LIFE SUPPORTING, ACTIVE IMPLANTED DEVICES OR SYSTEMS WITH PRODUCT FUNCTIONAL SAFETY REQUIREMENTS; (B) AERONAUTIC APPLICATIONS; (C) AUTOMOTIVE APPLICATIONS OR ENVIRONMENTS, AND/OR (D) AEROSPACE APPLICATIONS OR ENVIRONMENTS. WHERE ST PRODUCTS ARE NOT DESIGNED FOR SUCH USE, THE PURCHASER SHALL USE PRODUCTS AT PURCHASER'S SOLE RISK, EVEN IF ST HAS BEEN INFORMED IN WRITING OF SUCH USAGE, UNLESS A PRODUCT IS EXPRESSLY DESIGNATED BY ST AS BEING INTENDED FOR "AUTOMOTIVE, AUTOMOTIVE SAFETY OR MEDICAL" INDUSTRY DOMAINS ACCORDING TO ST PRODUCT DESIGN SPECIFICATIONS. PRODUCTS FORMALLY ESCC, QML OR JAN QUALIFIED ARE DEEMED SUITABLE FOR USE IN AEROSPACE BY THE CORRESPONDING GOVERNMENTAL AGENCY.

Resale of ST products with provisions different from the statements and/or technical features set forth in this document shall immediately void any warranty granted by ST for the ST product or service described herein and shall not create or extend in any manner whatsoever, any liability of ST.

ST and the ST logo are trademarks or registered trademarks of ST in various countries.

Information in this document supersedes and replaces all information previously supplied.

The ST logo is a registered trademark of STMicroelectronics. All other names are the property of their respective owners.

© 2014 STMicroelectronics - All rights reserved

STMicroelectronics group of companies

Australia - Belgium - Brazil - Canada - China - Czech Republic - Finland - France - Germany - Hong Kong - India - Israel - Italy - Japan - Malaysia - Malta - Morocco - Philippines - Singapore - Spain - Sweden - Switzerland - United Kingdom - United States of America

www.st.com



Стандарт Электрон Связь

Мы молодая и активно развивающаяся компания в области поставок электронных компонентов. Мы поставляем электронные компоненты отечественного и импортного производства напрямую от производителей и с крупнейших складов мира.

Благодаря сотрудничеству с мировыми поставщиками мы осуществляем комплексные и плановые поставки широчайшего спектра электронных компонентов.

Собственная эффективная логистика и склад в обеспечивает надежную поставку продукции в точно указанные сроки по всей России.

Мы осуществляем техническую поддержку нашим клиентам и предпродажную проверку качества продукции. На все поставляемые продукты мы предоставляем гарантию .

Осуществляем поставки продукции под контролем ВП МО РФ на предприятия военно-промышленного комплекса России , а также работаем в рамках 275 ФЗ с открытием отдельных счетов в уполномоченном банке. Система менеджмента качества компании соответствует требованиям ГОСТ ISO 9001.

Минимальные сроки поставки, гибкие цены, неограниченный ассортимент и индивидуальный подход к клиентам являются основой для выстраивания долгосрочного и эффективного сотрудничества с предприятиями радиоэлектронной промышленности, предприятиями ВПК и научно-исследовательскими институтами России.

С нами вы становитесь еще успешнее!

Наши контакты:

Телефон: +7 812 627 14 35

Электронная почта: sales@st-electron.ru

Адрес: 198099, Санкт-Петербург,
Промышленная ул, дом № 19, литера Н,
помещение 100-Н Офис 331